

We are IntechOpen, the world's leading publisher of Open Access books Built by scientists, for scientists

4,800

Open access books available

122,000

International authors and editors

135M

Downloads

Our authors are among the

154

Countries delivered to

TOP 1%

most cited scientists

12.2%

Contributors from top 500 universities



WEB OF SCIENCE™

Selection of our books indexed in the Book Citation Index
in Web of Science™ Core Collection (BKCI)

Interested in publishing with us?
Contact book.department@intechopen.com

Numbers displayed above are based on latest data collected.

For more information visit www.intechopen.com



Isothermal Titration Calorimetry: Thermodynamic Analysis of the Binding Thermograms of Molecular Recognition Events by Using Equilibrium Models

Jose C. Martinez, Javier Murciano-Calles, Eva S. Cobos,
Manuel Iglesias-Bexiga, Irene Luque and Javier Ruiz-Sanz

Additional information is available at the end of the chapter

<http://dx.doi.org/10.5772/53311>

1. Introduction

The revolution achieved during the last decade in the fields of genomics and proteomics has shown the need of going in-depth into the structural, dynamic, energetic and functional knowledge of biological macromolecules, mainly proteins and nucleic acids. Of special interest is the study of the molecular recognition between such kind of molecules or between them and other biological molecules, for example, natural metabolites or designed drugs to alter their functionalities.

Isothermal titration calorimetry (ITC) is a technique that directly measures the heat exchange accompanying a chemical or biochemical reaction. It is the ideal technique for the investigation of the energetics of ligand binding to biological macromolecules because it provides a complete thermodynamic characterization of the macromolecule-ligand interactions, allowing for the measurement of the binding affinity as well as of the changes in enthalpy and entropy of the process. The nature (enthalpic or entropic) and magnitude of the forces directing the interaction are very important factors to be considered in the design of ligands with specific characteristics. Additionally, the heat capacity of binding can be determined by carrying out titration experiments at different temperatures.

From the diverse methodologies that can be applied in the research of binding processes, ITC presents a series of advantages and possibilities, and as such it is considered a very powerful tool. Precluding the structural interpretation, the direct determination of binding thermodynamic parameters becomes necessary to describe the energetic aspects of the

binding and, thus, to define and to rationalize macromolecular recognition. Nevertheless, although calorimetry has been widely used as an experimental resource, it has not always been interpreted correctly, mainly due to the difficulty found in extracting thermodynamic information from experimental data. Thus, the rigorous analysis of ITC thermograms should be done under the assumption of theoretical models, able to describe the most significant stages present during the binding process and which application would give rise to valuable thermodynamic information for each of such stages.

2. General aspects of binding equilibrium

Through this Chapter we are going to scrutinise the use of ITC in the study of binding equilibrium processes, as well as how to design and perform the experiments and the correct way to handle the data and achieve the corresponding fit to the proper equilibrium models. Nevertheless, prior to focusing on the different ITC aspects, we will describe briefly some basic features of binding equilibrium, for which it is crucial to introduce some basic concepts and equilibrium formulas.

2.1. Basic concepts

Apart from the capacity of self-copying, biomolecules are characterized by their ability to specifically interact with other molecules within the cell, which defines their biological functionality. Many of the biochemical processes occurring in living systems are based on, or regulated by, binding interactions between biological macromolecules or with other small molecules. Examples of interactions between macromolecules can be found out in interactions between polypeptide chains to form the quaternary structure of multi-subunit proteins, in the close association of protein and RNA molecules in the ribosome, in the binding of transcription regulators to DNA, protein-protein interactions in many signalling cascades, etc. Besides, many biological macromolecules bind small molecules, for example, enzymes that bind substrates and effector molecules, or proteins that bind metabolites in order to transport or store them. Signalling transmission is also based on interactions, as those of hormones with membrane receptors. Additionally, some of the regulation pathways of the transcription and replication of nucleic acids involve the change of their conformations induced by binding of metallic ions.

The interactions that can take place under different backgrounds and contexts from a physico-chemical point of view, can be summarized into three different types: i) at *equilibrium*, ii) at *steady-state conditions*, and iii) at the *transition between different steady-state conditions*. In this Chapter, we will direct attention to the first case, the binding equilibrium process between a biological macromolecule (such as a protein or a nucleic acid) and a small molecule, called a *ligand*, occurring by *specific* interactions, that is, the ligand (L) binds at specific sites of the macromolecule (M). The establishment of such specific interactions is crucial for the correct functioning of the cell, as happens in the most of biological processes, where one or more macromolecule-ligand (ML) interactions are involved, determining and regulating the biological function.

All these ML interactions present some common features:

- Binding of the ligand involves a non-covalent *reversible* interaction to a specific region of the macromolecule, called the *binding site*, usually situated at its surface or close to it.
- The ligand binding process may induce conformational changes that modify the activity of the macromolecule; this phenomenon is known as *alosterism*.
- When the macromolecule has more than one binding site, the binding of one ligand to one of the sites may change the affinity of the ligand for the rest of binding sites; this feature is known as *co-operativity* and is closely related to the alosterism phenomenon.
- In some cases, the binding process can result in a change in the aggregation state of the molecules (*polisterism*) or, even, give rise to a new phase in the system (*poliphasic processes*). These two aspects are not within the scope of this Chapter.

The correct characterization of the binding process requires some experimental work in order to determine a variety of parameters such as:

- **Number of binding sites** per macromolecule for a defined ligand, n . The numeric value can be one or higher, sites can be identical or different in terms of affinity into the same macromolecule.
- **Binding parameter**, $\bar{\nu}$. Represents the moles of bound ligand by each mole of macromolecule. It ranges between zero and the number of binding sites, n .
- **Saturation fraction**, θ . The fraction of the total number of sites of the macromolecule occupied by ligand molecules, which ranges from zero (no occupancy) to one (all sites occupied). It can be easily deduced that $\bar{\nu} = n \cdot \theta$.
- **Binding affinity** of the ligand to the macromolecule, expressed by means of the equilibrium binding constant, K_b , or the corresponding Gibbs energy change, $\Delta G_b = -RT \cdot \ln K_b$. As mentioned above, ITC experiments provide a complete thermodynamic characterization of the macromolecule-ligand interactions, allowing the determination of the binding affinity as well as the changes in enthalpy, ΔH_b , and entropy, ΔS_b , of the binding process, where $\Delta G_b = \Delta H_b - T \cdot \Delta S_b$.
- $\bar{\nu} / (n - \bar{\nu})$ is the **relationship between occupied ($\bar{\nu}$) and empty ($n - \bar{\nu}$) sites** in the macromolecule.

Thus, binding studies can provide the answer to some fundamental questions related to the functional aspects of biological macromolecules, such as, for example: How many binding sites in the macromolecule for a defined ligand exist? What is the affinity of the ligand for each binding site? Is there any dependency or inter-connection among the sites? Can affinity be modulated by the proper ligand molecule or by any other metabolites?

The experimental data is ideally expressed in terms of changes in the binding parameter, $\bar{\nu}$, as a function of the free ligand concentration in solution, $[L]$. In practice, it is necessary to move along the whole equilibrium process, starting usually from a solution containing the free macromolecule where the ligand solution is added progressively until the saturation of all sites is achieved. During this titration process, we should measure the binding parameter, generally by using spectroscopic or calorimetric probes. This kind of approach allows us to know the total concentration of both macromolecule, $[M]_T$, and ligand, $[L]_T$, in the solution.

2.2. The Adair's equation

This equation defines the type of equilibrium that can be established between a macromolecule and its ligand upon binding.

2.2.1. Binding to one site

In order to establish how the equilibrium constants can be determined from experimental data we are going to develop the simplest binding process, described by the binding of a ligand to a macromolecule which has only one binding site. It can be expressed as following:

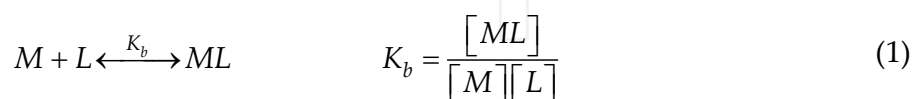

Although the thermodynamic equilibrium constant that characterizes the binding process, K_b , must be expressed as a function of the activities of the different species present at equilibrium, it is usual to use concentrations instead of this, as experimental data contains larger errors than the ones derived from this approximation.

As we have stated previously, a very useful parameter obtained by experimental data is the *binding parameter*, $\bar{\nu}$, defined as the average of ligand molecules that are bound per macromolecule, its range from 0 to n (number of binding sites per macromolecule). Mathematically it can be defined as:

$$\bar{\nu} = \frac{[L]_b}{[M]_T} = \frac{[ML]}{[M] + [ML]} = \frac{K_b [L]}{1 + K_b [L]} \quad (2)$$

The representation of $\bar{\nu}$ versus $[L]$ (free ligand concentration) gives the so called *binding curve*. As shown in Figure 1, our simple example corresponds to a hyperbolic curve trending asymptotically to the number of sites n ($n=1$ in this case), because saturation conditions are reached as the free ligand concentration increases.

The value of the equilibrium constant, K_b , can be determined from the non-linear fitting of the experimental data, represented in the binding curve, to equation 2. In the case of a single binding site, it is also possible to convert equation 2 into a variety of linear equations to obtain the K_b value from the corresponding linear regression.

Such linear representations (Figure 1) can be easily deduced from the previous equations and are named as follows:

Double reciprocal representation:

$$\frac{1}{\bar{\nu}} = 1 + \frac{1}{K_b [L]} \quad (3)$$

Hill representation:

$$\log\left(\frac{\bar{\nu}}{1-\bar{\nu}}\right) = \log(K_b [L]) \quad (4)$$

- Scatchard representation:

$$\frac{\bar{\nu}}{[L]} = K_b - K_b \bar{\nu} \quad (5)$$

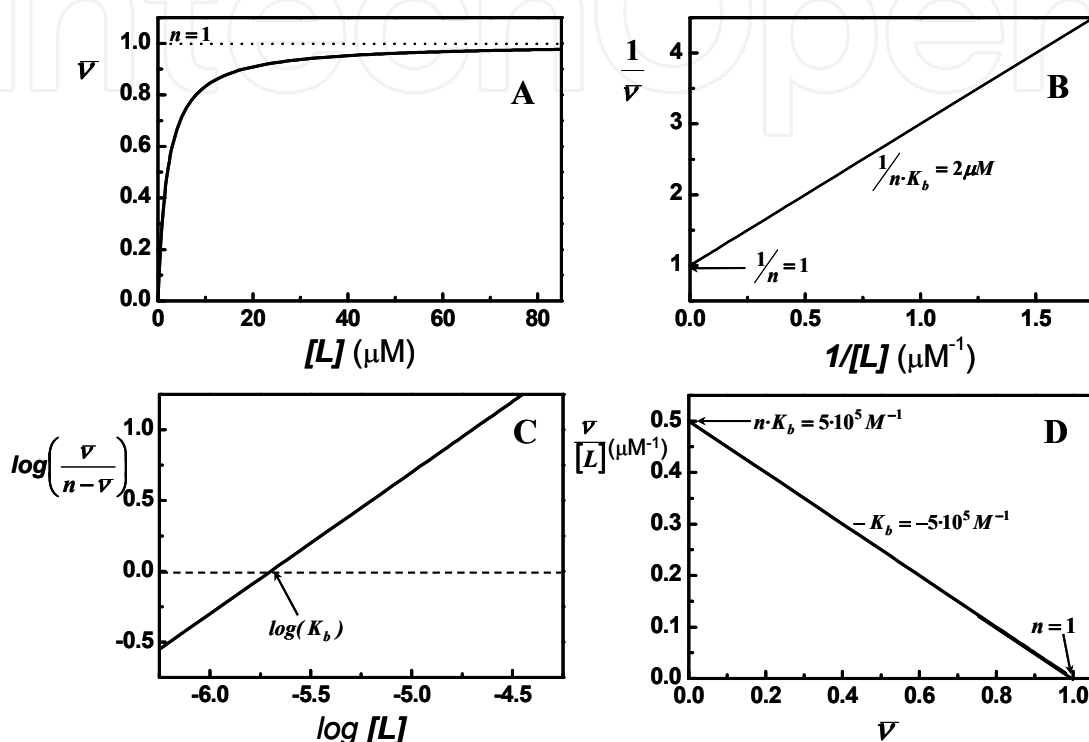

Figure 1. Binding to one site

Different representations of simulated data for the binding equilibrium of a ligand to a macromolecule with a single binding site with $K_b = 5 \cdot 10^5 \text{ M}^{-1}$. (A) Binding curve. (B) Double reciprocal representation. (C) Hill representation. (D) Scatchard representation.

Another accessible parameter from binding experiments is the *saturation fraction*, θ , defined as the fraction of binding sites occupied by ligand. It is related to the binding parameter by the expression: $\theta = \bar{\nu} / n$

Depending on the techniques used to obtain the experimental data of the binding equilibrium processes, it is possible to determine either the binding parameter, $\bar{\nu}$, or the saturation fraction, θ , and then, to develop the subsequent analysis to determine the rest of parameters of interest.

The most appropriate technique to determine $\bar{\nu}$ is ITC [1, 2]. It can also be achieved by equilibrium dialysis, which allows the calculation of the concentrations of the free ligand in equilibrium with the different species of the macromolecule (free and bound), in order to construct directly the binding curve. Although this technique provides the complete set of experimental data required, it requires extensive work and also needs large amounts of sample.

The techniques that allow the determination of θ values are based on detecting physical change occurring in the macromolecule or in the ligand during the binding process. Such physical change has to be a linear function, as the ligand is bound to the macromolecule. Furthermore, if the macromolecule presents several binding sites, the change must be the same for all of them or, at least, the change relationship between the binding sites must be known. Depending on the nature of the physical change, different techniques may be used: UV-visible spectroscopy, fluorescence, circular dichroism, nuclear magnetic resonance spectroscopy, etc [1, 2].

2.2.2. Binding to two equivalent and independent sites

2.2.2.1. Macroscopic formulae

Here, we are going to describe the formulae of the equilibrium processes corresponding to the binding of a ligand to a macromolecule with two binding sites. In this stage, we will focus on the simplest situation, where both sites are equal in affinity and independent, *i.e.*, not influencing each other upon ligand binding. Binding schemes where these basic assumptions do not occur can be useful to describe cooperative interactions and will be described later on in this Chapter. To obtain the binding parameters we can use elementary thermodynamics for the simplest non-cooperative cases, but as the cases turn more complex, this formulae becomes very laborious and a more general formulae is needed.

In order to strengthen the binding concepts, we will start by applying the classical formulae to this simple case, before the description of the general formulae introduced in the biochemical field by Wyman [3], which is useful for the formulae of more complicated binding schemes. Thus, in the case of a macromolecule with two equivalent and independent binding sites, the description of the formulae from a **macroscopic** point of view can be developed in two different but equivalent ways:

- Stage formulae: A first equilibrium stage is considered, where M binds to one ligand molecule, L, followed by a second stage where a second L molecule binds to M, achieving saturation. These two stages are characterized by their corresponding equilibrium constants as follows:

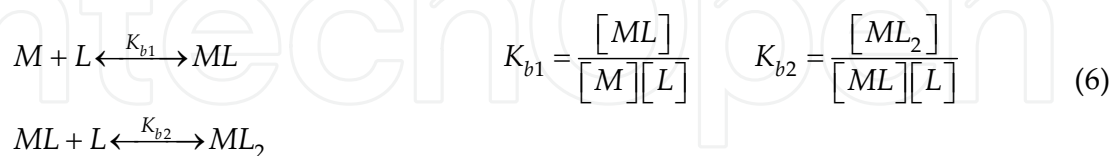

- Global formulae: The equilibria take place between both the free and the bound M species to either one or two ligand molecules. The equilibrium constants for this formulae are related with the ones of the previous formulae as follows:

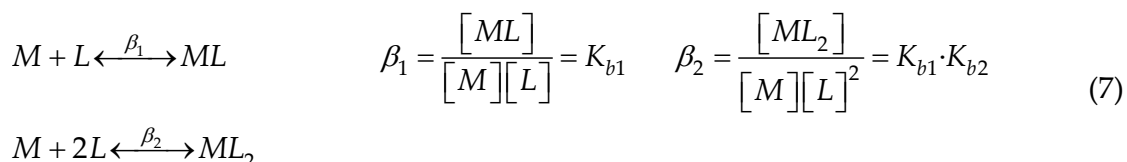

The binding equilibrium constants K_b and β are named as *macroscopic constants*.

In this case, where the macromolecule has two equivalent and independent binding sites, the binding parameter, $\bar{\nu}$, can be calculated as:

$$\bar{\nu} = \frac{[ML] + 2[ML_2]}{[M] + [ML] + [ML_2]} = \frac{K_{b1}[L] + 2K_{b1}K_{b2}[L]^2}{1 + K_{b1}[L] + K_{b1}K_{b2}[L]^2} = \frac{\beta_1[L] + 2\beta_2[L]^2}{1 + \beta_1[L] + \beta_2[L]^2} \quad (8)$$

2.2.2.2. Microscopic formulae

When more than one binding site exists, the binding process can be described using a **microscopic formulae**, that is, distinguishing each binding site. Thus, as it is shown in Figure 2, the first ligand molecule can bind to binding site 1 of M, being the equilibrium process characterized by the microscopic binding constant k_1 ; or to the binding site 2 and then, characterized by k_2 . The second ligand molecule will bind to the free binding site, and the equilibrium will be characterized by k_3 if the free site is the number 2 or k_4 if it is the number 1.

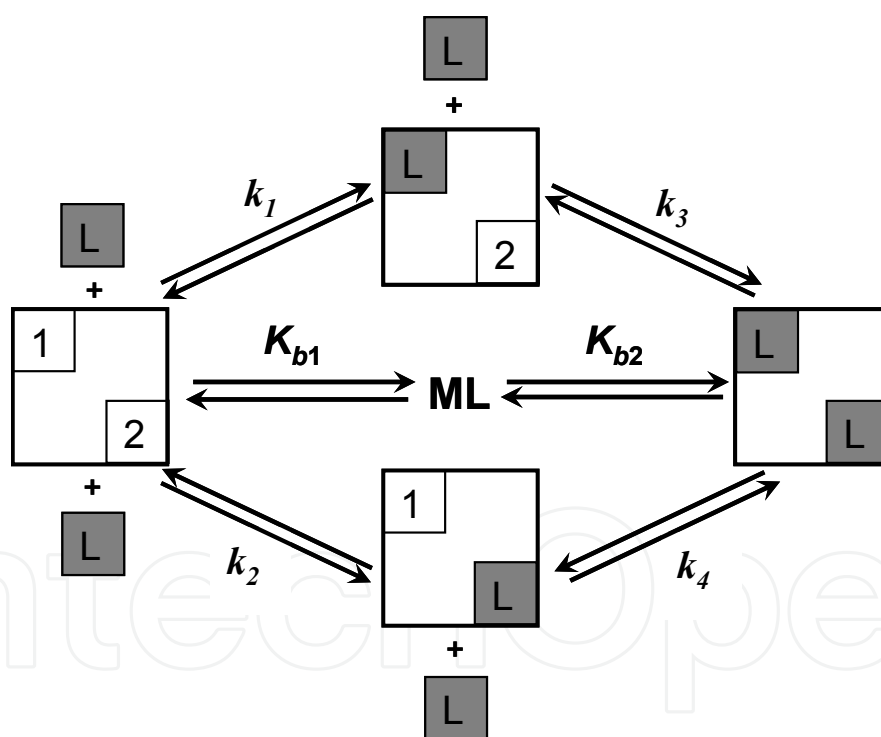

Schematic representation to distinguish between the macroscopic and microscopic formulae for the binding equilibria of a general ligand L to a macromolecule with two binding sites.

Figure 2. Binding to two sites

For the case we are explaining, the meaning of having equivalent binding sites is that $k_1 = k_2$ and $k_3 = k_4$. Also, independent binding sites imply that $k_1 = k_4$ and $k_2 = k_3$. So, in binding processes where all binding sites are equivalent and independent, all microscopic equilibrium constants will be identical. The relations between macroscopic, K_b , and

microscopic, k , equilibrium constants are: $K_{b1} = 2k$ and $K_{b2} = k/2$. Thus, although microscopic constants are identical, the macroscopic ones are different due to statistical factors. By using the microscopic constants instead of the macroscopic ones, a simpler expression for the binding parameter than that given in equation 8 is obtained:

$$\bar{v} = \frac{2k[L]}{1 + k[L]} \quad (9)$$

Therefore, it is interesting to know the relationships between the equilibrium constants obtained using the different formulae; such relationships between microscopic and macroscopic constants may allow it to be deduced whether the binding sites are independent or not. Meanwhile, the use of microscopic constants will simplify the equation of the binding parameter which, as mentioned above, is the experimentally accessible parameter, besides the fraction saturation.

2.2.3. Binding to n equivalent and independent sites

We can obtain the relationship between the different types of binding constants for the general case of a macromolecule having n equivalent and independent binding sites. Firstly, we proceed to apply the macroscopic formulae in its two ways, which are summarized in the next scheme:

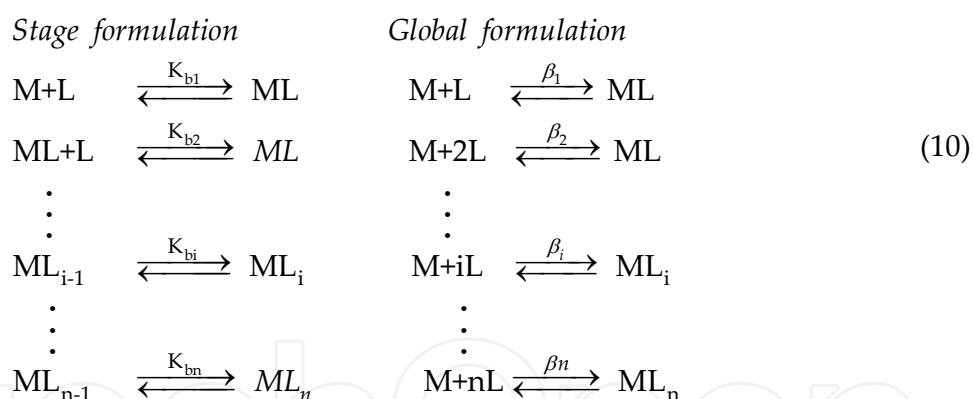

Looking at the equations defining the macroscopic binding parameter (equations 2 and 8) we can easily deduce that, in the case of having n equivalent and independent binding sites, this variable can be written in general as

$$\bar{v} = \frac{[L]_b}{[M]_T} = \frac{\sum_{i=1}^n i [ML_i]}{\sum_{i=0}^n [ML_i]} \quad (11)$$

where ML_i refers to the macromolecule with i bound ligand molecules. For a general stage i we can obtain the relation between both macroscopic constants, considering that the concentration of ML_i may be expressed as:

$$[ML_i] = K_i \cdot [ML_{i-1}] \cdot [L] = K_i \cdot K_{i-1} \cdot [ML_{i-2}] \cdot [L]^2 = K_i \cdot K_{i-1} \cdot \dots \cdot K_1 \cdot [M] \cdot [L]^i \quad (12)$$

So:

$$\beta_i = \frac{[ML_i]}{[M][L]^i} = K_i K_{i-1} \dots K_1 = \prod_{j=1}^i K_j \quad (13)$$

Taking into account the equation 11, the binding parameter, expressed in terms of the macroscopic constants, is:

$$\bar{v} = \frac{\sum_{i=1}^n i \cdot \beta_i \cdot [L]^i}{\sum_{i=0}^n \beta_i \cdot [L]^i} \quad (14)$$

This equation is known as *Adair's general equation*, being the denominator the so called *binding polynomial*.

As equation 14 presents a very high number of macroscopic constants, it is interesting to deduce the relation between microscopic and macroscopic equilibrium constants, to obtain a more simple expression for the binding parameter. Firstly, it is necessary to know the number of possible microscopic states of each macroscopic species. Thus, for ML_i species it will be the number of different ways to arrange i ligands into n binding sites, which corresponds to the combinatorial of n elements taken in groups of i . Since all binding sites are equivalent and independent, all the possible microscopic forms for any macroscopic species are equally probable and, therefore, they will be at the same concentration; then, the concentration of the macroscopic ML_i species expressed as the concentration of its microscopic forms is:

$$[ML_i] = \frac{n!}{(n-i)!i!} [ML_i]_{micro} \quad (15)$$

So the microscopic equilibrium constant, k , will be:

$$k = \frac{[ML_i]_{micro}}{[ML_{i-1}]_{micro} [L]} = \frac{(n-i)!i! [ML_i]}{(n-i+1)!(i-1)! [ML_{i-1}] [L]} = \frac{i}{n-i+1} K_{bi} \quad (16)$$

The macroscopic constant β_i is obtained from equations 13 and 16 as

$$\beta_i = \frac{n!}{(n-i)!i!} k^i \quad (17)$$

The binding parameter expressed in terms of microscopic constants can be obtained from equations 14 and 17 as

$$\bar{\nu} = \frac{\sum_{i=1}^n i \frac{n!}{(n-i)!i!} k^i [L]^i}{\sum_{i=0}^n \frac{n!}{(n-i)!i!} k^i [L]^i} = \frac{nk[L](1+k[L])^{n-1}}{(1+k[L])^n} = \frac{nk[L]}{1+k[L]} \quad (18)$$

where the resulting expression has been obtained by taking into account the binomial theorem. Once again, the binding parameter, expressed in terms of microscopic constants, gives a quite simple expression with a reduced number of fitting parameters, since a single k value is always expected for all microscopic binding constants in the case of a binding process where binding sites are equivalent and independent.

2.3. A general formulae for non-cooperative binding. The binding polynomial

At this point, we have explained the simplest cases of binding equilibrium, where binding sites are equivalent and independent. When more complex schemes are considered, the use of classical thermodynamic formulae to obtain the binding parameter turns complicated and laborious, as was mentioned previously. Thus, it is more convenient to use a general formulae which will allow obtaining $\bar{\nu}([L])$ expressions, systematically and independently of the complexity of the case in study. This general formulae is based on the construction of a function, which may be described as the macroscopic analogue of the grand canonical partition function from statistical thermodynamics. This function was introduced in the biochemical field by Wyman [3] and then, applied to ligand binding [4-7].

In order to apply this general formulae to ligand binding systems, firstly, it is necessary to construct the *partition function*, and then, apply it to the system under study. Let us explain briefly the steps to obtain the partition function:

- Identify the different energetic accessible states of the system: in a binding process it would be the different species of the macromolecule (free and bound) in equilibrium with the ligand.
- Determine the energy of each accessible state: it would be equivalent to specify the equilibrium constants given by the mass action law.
- Choose a reference state, that is, a reference specie: it can be chosen any of the identified ones, though is preferable to choose the state (species) with the lowest energy; for a binding process is the free macromolecule (M).
- Calculate the statistical weight of each state (species) with respect to the reference one. The statistical weight for a state i , W_i , is

$$W_i = D * \exp\left(\frac{-\Delta E_i}{RT}\right) \quad (19)$$

where D is the degeneration of each state, and $\Delta E_i = E_i - E_{ref}$

For a binding process the statistical weight of the specie ML_i is

$$W_i = [ML_i] / [M] = \beta_i [L]^i \quad (20)$$

Construct the partition function, Z , as the sum of the statistical weights of all accessible states (or species): $Z = \sum_i W_i$. For binding processes the partition function is expressed as

$$Z = \sum_{i=0}^n \frac{[ML_i]}{[M]} = \sum_{i=0}^n \beta_i [L]^i \quad (21)$$

Based on this formalism it is possible to easily obtain interesting expressions such as

Probability of each accessible state, P_i , which is the fraction of each species at equilibrium in the binding process

$$P_i = \frac{W_i}{Z} = \frac{\beta_i [L]^i}{\sum_{i=0}^n \beta_i [L]^i} \quad (22)$$

- Average quantities of interest for the system, that is, measured values of any magnitude. For a magnitude a

$$\langle a \rangle = \sum_{i=0}^n a_i \cdot P_i \quad (23)$$

where a_i corresponds to the value of the magnitude a for the state i (specie i).

Thus, the binding parameter, $\bar{\nu}$, corresponds to the average of ligand bound to the macromolecule and can be calculated as follows

$$\bar{\nu} = \langle i \rangle = \sum_{i=0}^n i \cdot \frac{W_i}{Z} = \sum_{i=0}^n i \cdot \frac{\beta_i [L]^i}{\sum_{i=0}^n \beta_i [L]^i} = \frac{\sum_{i=0}^n i \cdot \beta_i [L]^i}{\sum_{i=0}^n \beta_i [L]^i} \quad (24)$$

Of course, the expression obtained is the Adair's equation (equation 14) and the denominator, which corresponds to the binding polynomial, can be identified with the partition function.

There is also a direct way to calculate the binding parameter, based on the calculation of the partial derivative of $\ln Z$ in respect to $\ln[L]$ at constant P and T, as is shown below:

$$\bar{\nu} = \left(\frac{\partial(\ln Z)}{\partial(\ln[L])} \right)_{P,T} = \frac{[L]}{Z} \left(\frac{\partial Z}{\partial[L]} \right)_{P,T} = \frac{[L]}{Z} \left(\frac{\partial \left(\sum_{i=0}^n \beta_i [L]^i \right)}{\partial[L]} \right)_{P,T} = \frac{\sum_{i=0}^n i \cdot \beta_i [L]^i}{\sum_{i=0}^n \beta_i [L]^i} \quad (25)$$

If we apply this general formulae to the case of the binding of a ligand to a macromolecule with n equivalent and independent binding sites, we can obtain the same expression than that given in equation 18. It is interesting to note that, since the binding sites are independent, the partition function corresponds to the product of the partition sub-function for each binding site. Therefore, the binding parameter can also be expressed as the sum of the binding parameter for each binding site. Additionally, if the sites are equivalent, such parameters will be equal to n times the value of the binding parameter obtained for one of the sites.

In the case of a macromolecule with n different and independent binding sites, the partition function can also be expressed as the product of the partition sub-functions for each binding site, though as the sites are different these partition sub-functions will not be equivalent. Consequently, the binding parameter will be the sum of the binding parameter corresponding to each site.

2.4. Experimental analysis of binding equilibria to independent sites

Prior to describing cooperative phenomena, in this Section we will describe how the analysis of the different graphical representations mentioned in Section 2.2.1 may help to rationalize the experimental data to get information about, for example, the existence of different kinds of binding sites for the ligand and how the equilibrium constants describing ligand binding can be estimated.

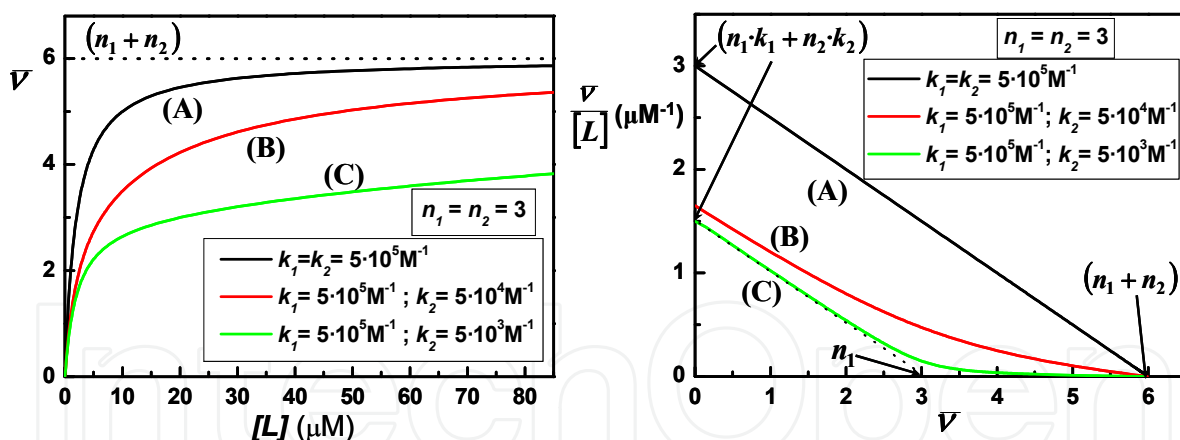

Simulation examples for the binding equilibrium of a ligand to a macromolecule with one or two different classes of sites, to show the differences in the binding curves (left panel) and in the Scatchard representation (right panel). Curve A corresponds to the ligand binding to six equivalent and independent sites, with a microscopic constant of $5 \cdot 10^5 \text{ M}^{-1}$. Curves B and C correspond to the binding to two different kinds of sites, each class with 3 sites: for curve B the ratio between microscopic constants of the two binding site classes is $k_1 = 10k_2$; for curve C the ratio is $k_1 = 100k_2$.

Figure 3. Binding to independent sites

The easiest representation of experimental data is the binding curve (Figures 1 and 3). Simulations carried out with the equations described above, by using the different \bar{v} ($[L]$) expressions obtained in the earlier sections indicate that a hyperbolic shape of this curve will represent a binding process corresponding to a macromolecule with equivalent and

independent sites, being n estimated from the asymptotic value of the graph (curve A). When the macromolecule displays different kinds of sites, characterized by different values of microscopic constants, the shape of the curve changes, becoming more difficult to distinguish from the former simpler case when such values become similar (curves B and C). The shape will be the equivalent to the sum of two or more hyperbolic binding curves with two or more different k values.

The Scatchard representation would be more helpful to distinguish between equal or different kinds of independent sites (Figure 3). From the intersection with the X-axis the number of binding sites can be easily determined when sites are equal (curve A). In the case of different kind of sites n estimation is difficult, although we can obtain the number of sites of the highest affinity and the respective k value from the extrapolation of the initial linear tendency (see figure).

The Hill representation is fundamentally informative to distinguish between independent (non-cooperative) and dependent (cooperative) sites in the macromolecule, and will be analyzed in detail into the next Section.

2.5. Experimental analysis of binding cooperativity (non-independent sites)

Up to now we have referred only to binding processes where all binding sites are independent. It is time to introduce the effect of binding cooperativity, which means that the interaction of the ligand with one of the sites of the macromolecule produces an alteration of the affinity that the other sites have for such ligand. We can distinguish between *positive cooperativity*, when the binding of a ligand increases the affinity of the rest of binding sites, and *negative cooperativity*, when such affinity is decreased. These changes in affinity are usually related to conformational changes in the macromolecule, that is, what was referred to at the beginning of the chapter as *alosterism*. From a practical point of view, cooperativity can be viewed as a way to regulate the biological activity as a function of ligand concentration.

Although the Adair equation is still a valid approach, as we described in Section 2.4, it could be difficult to distinguish among the different equilibria and, in addition, it may contain an excessive number of equilibrium constants to be estimated from fitting. Thus, different strategies have been described to analyze cooperativity, as will be explained into the next Section. Prior to this description, let us first describe how to determine cooperativity from analysis of experimental data.

The binding curve reveals an S-shape when cooperativity is positive. From the Scatchard representation positive cooperativity can also be easily discernible from any scheme of independent binding sites, since a concave shape of the experimental data is revealed (Figure 4). However, negative cooperativity can be confused with the scheme of different and independent sites (compared to Figures 3 and 4). The Hill representation is the most useful to distinguish between dependent and independent types of binding sites. In Figure 4 both situations have been simulated. When a non-cooperative behaviour is revealed, a

single straight line with a slope equal to one is obtained, while when a positive cooperative behaviour occurs, the Hill analysis shows an increase of the slope at the central region (S-shape). The decrease of this region will indicate negative cooperativity. The slope of this region is known as the *Hill coefficient*, n_H . The explanation is as follows:

At very low ligand concentrations, the binding occurs statistically at different sites allocated in different macromolecule units, all of them free of ligand. Thus, at this stage cooperativity phenomena are not revealed experimentally. This “non-cooperative” initiation of the binding process results in a straight line with slope equal to one. Thus, equation 4 converts into

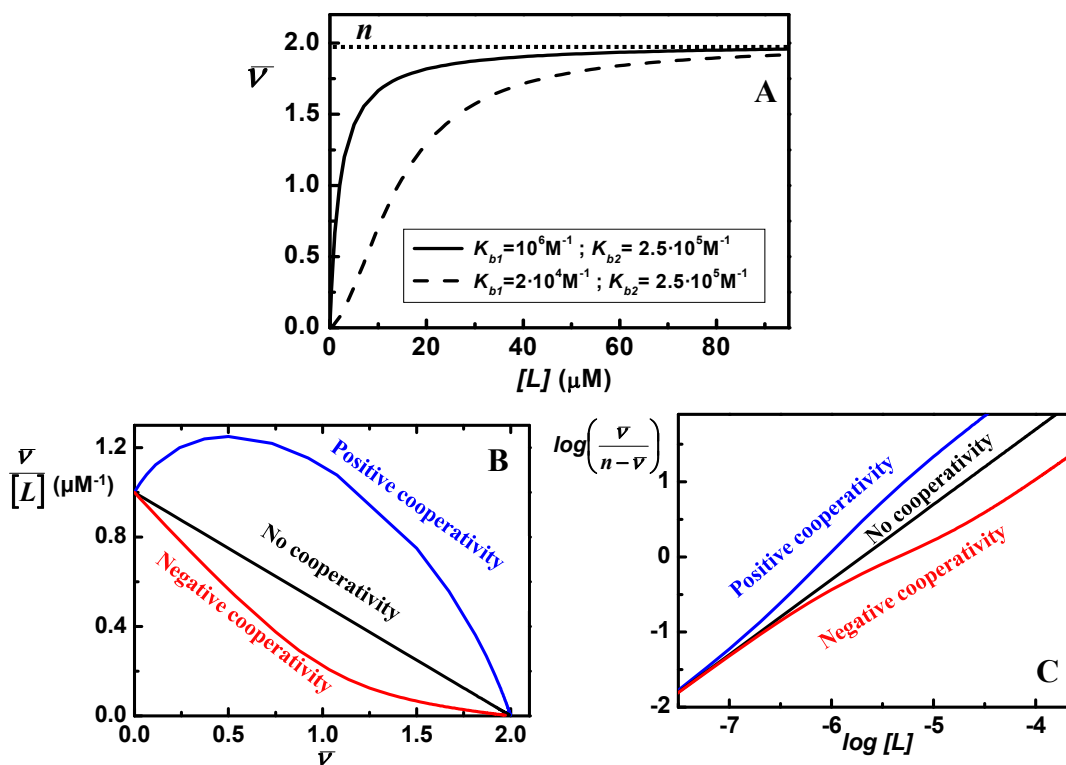

Graph A shows some simulations of the binding curve for the ligand binding to a macromolecule with two binding sites, with a microscopic constant of $k=5 \cdot 10^5 \text{ M}^{-1}$: solid line curve corresponds to equal and independent binding sites, and dashed line curve to equal sites showing positive cooperativity (the binding of a ligand increases fifty times the affinity for the second ligand molecule). Graphs B and C show the Scatchard and Hill representations respectively. In both panels simulated curves correspond to $k=5 \cdot 10^5 \text{ M}^{-1}$ and the affinity for the second site is increased (for positive cooperativity) or decreased (negative cooperativity) five times.

Figure 4. Binding to cooperative sites

$$\log\left(\frac{\bar{v}}{n-\bar{v}}\right)_{[L] \rightarrow 0} = \log \frac{K_1}{n} + \log [L] \quad (26)$$

At moderate saturation of the macromolecule, the ligand binds to sites where affinity has changed (second and subsequent sites of the macromolecule). As a result, the slope of this region of the Hill curve will change to values higher than one in the case of positive cooperativity, or lower than one for negative cooperativity. Thus, the slope will achieve its

maximum experimental value around half of saturation. The maximum theoretical value in this zone will be hypothetically reached in the case of infinite cooperativity, where only the free and fully saturated M species are significantly populated. In this case, it can be demonstrated that this slope can be equal to n . In the real cases where cooperativity is finite, the value will range between $1 < n_H < n$

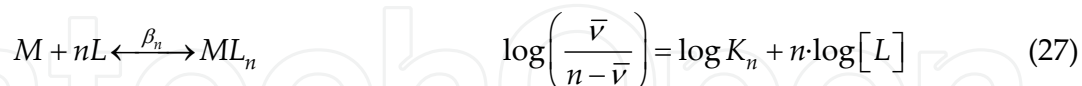

- At very high ligand concentrations, reaching saturation of the macromolecule, for almost the totality of macromolecules all sites are occupied by ligand molecules except one of them and the binding to this last site does not influence binding affinity. Therefore, the slope returns again to be equal to 1 (Figure 4) and it can be deduced from the mathematical expression of the Hill equation in the limit of strong binding that

$$\log\left(\frac{\bar{v}}{n - \bar{v}}\right)_{[L] \rightarrow \infty} = \log(n \cdot K_n) + \log[L] \quad (28)$$

2.6. Physico-chemical description of binding cooperativity

2.6.1. Phenomenological description

This approach does not imply the assumption of any structural model for the ML_i species. For a situation where sites are independent it is assumed that only one microscopic binding constant, k , exists, but there are different macroscopic constants, K_i , for the different equilibriums, according to the scheme shown in Figure 5.

Therefore, the binding polynomial can be generally described as

$$Z = 1 + K_1[L] + K_1K_2[L]^2 + K_1K_2K_3[L]^3 + K_1K_2K_3K_4[L]^4 + \dots \quad (29)$$

In general, we can also assume that the relationship between macroscopic and microscopic binding constants can be

$$K_i = \frac{\text{Isoforms of } ML_i}{\text{Isoforms of } ML_{i-1}} k \quad (30)$$

By replacing this equation in the binding polynomial, we obtain the phenomenological expression for this function, and then, by using equation 25 the binding parameter can be estimated. In the case of cooperative sites, this description assumes that the microscopic binding constant changes upon binding, increasing when positive cooperativity happens, and decreasing for negative cooperativity. This approach does not explain the molecular reasons of such a change, as do the following schemes, but it represents an easy way to estimate the equilibrium constants in these cases.

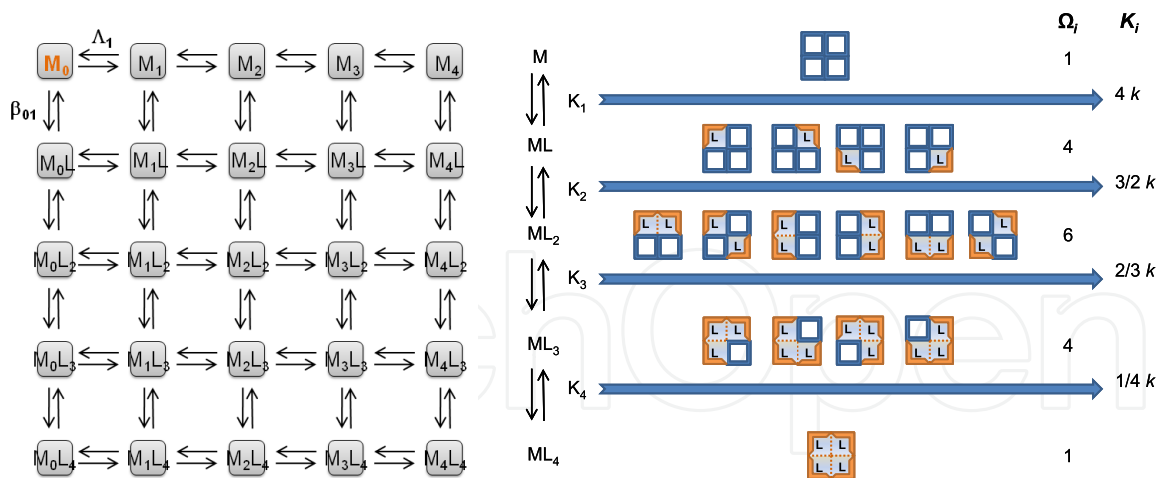

Left side shows the matrix of the model, where columns represent ligand binding equilibria and rows the conformational changes associated to a hypothetical macromolecule displaying four cooperative binding sites for the ligand. Right side shows the relationship between macroscopic and microscopic constants, where Ω_i represents the number of isoforms of ML_i .

Figure 5. Phenomenological description of binding cooperativity

2.6.2. The Koshland-Nemety-Filmer model

The basics of this model were initially proposed by Pauling to study the cooperative binding of oxygen to haemoglobin [8]. It can explain both, positive and negative cooperative behaviours. More interesting, this model assumes that the different binding sites of the macromolecule are influencing each other through their mutual interconnection by means of a molecular ligature, σ . In Figure 6 we have represented this situation for a macromolecule with four binding sites for the ligand L. It must be considered that when every site is occupied by L, it breaks the ligature with the others, resulting in a modification of their binding affinities. Then, the mathematical expression for the binding polynomial is:

$$Z = \sum_{i=0}^n I_i \frac{k^i}{\sigma^{B_i}} [L]^i \quad (31)$$

where I_i are the number of possibilities of allocating i ligands into the macromolecule, and B_i is the number of broken ligatures for each configuration. The results for the case of a macromolecule with four binding sites are collected into Figure 6 as an example.

This description can be modified as a function of the experimental behaviour of every macromolecule-ligand example. It might be easily developed for the case of different microscopic constants or, even, of different contribution of the ligatures. The main advantage with respect to the phenomenological description is that it can reveal molecular aspects of cooperative phenomena when applied.

2.6.3. The Monod-Wyman-Changeux model

Although this model has been widely used in the literature [4, 9], it can only be used to describe positive cooperativity, which is expressed by assuming that the macromolecule can

exists in at least two different conformations, which are under mutual equilibria, and differ in their affinities for the ligand. Within every conformation, the binding sites behave as if they were equivalent and independent for the binding of L.

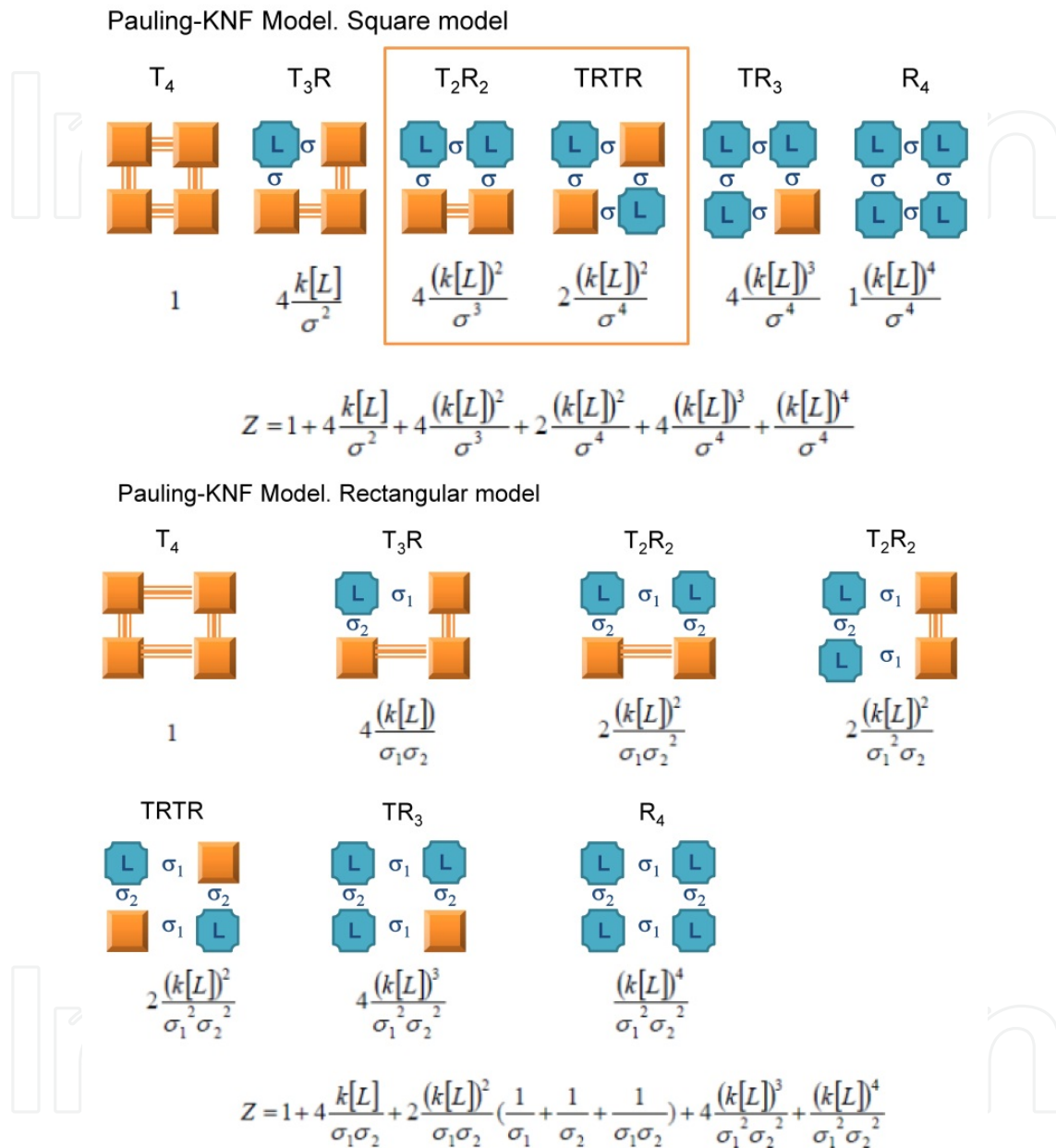

The upper scheme represents the so-called square version of this model for a hypothetical macromolecule displaying four cooperative binding sites for the ligand and only one kind of ligature. The lower panel shows the rectangular version, with two kinds of ligatures. In both cases we also show the corresponding formulae of the partition function, Z, below each one.

Figure 6. The Koshland-Nemety-Filmer model of binding cooperativity

In Figure 7 a schematic diagram is shown for the case of a macromolecule with four binding sites and two (left side) distinct conformations under equilibrium. In this situation, it is usually assumed that the allosteric equilibrium constant, Λ , is initially big enough to move

the equilibrium towards the T-state, considered as the low affinity state. Upon addition of the ligand, the equilibrium moves towards the R-state, of higher affinity than the former. Therefore, this displacement will allow the rest of sites to bind the ligand with higher affinity than the first one. This progressive displacement to the R-state may, thus, explain an increase in affinity (positive cooperative), but not the opposite.

The binding polynomial can be mathematically expressed as

$$Z = \frac{1}{1+\lambda} (1+k_R[L])^n + \frac{\lambda}{1+\lambda} (1+k_T[L])^n \quad (32)$$

This model can be easily generalized to more than two conformations of the macromolecule by adding additional terms to this general equation. For example, for the case of three conformations (right side of Figure 7):

$$Z = \frac{1}{1+\lambda+\varpi} (1+k_R[L])^n + \frac{\lambda}{1+\lambda+\varpi} (1+k_T[L])^n + \frac{\varpi}{1+\lambda+\varpi} (1+k_S[L])^n \quad (33)$$

and so on.

3. Notes on ITC performance and general experimental procedures

As was mentioned in the Introduction, ITC is a thermodynamic technique that directly measures the heat released or absorbed in an intermolecular interaction, such as ligand-protein interactions, protein-protein interactions, etc [10]. An ITC experiment consists of a calorimetric titration of a specific volume of one of the reagents, usually the macromolecule, with controlled quantities of the other reagent, usually the ligand, at constant temperature and pressure. Thus, the measured heat during the titration corresponds to the enthalpy of such interactions [11]. This relatively easy experiment allows a complete and precise thermodynamic characterization of the binding event. Subsequently, if the thermal effect is high enough, and the value of the binding constant is moderately good, a single ITC experiment can establish the equilibrium binding constant, K_b , the apparent enthalpy change, ΔH_{app} , and the stoichiometry of the reaction, n . Additionally, if the experiments are made at different temperatures, the change of heat capacity of the process, ΔC_{pb} , can also be measured.

The most common titration calorimeters are adiabatic and are based on the compensation of the thermal effect generated by the addition of the ligand into the sample cell, which is placed in an adiabatic environment [11]. In the left side of Figure 8 we show a schematic representation of one of these instruments. A thermoelectric device measures the temperature difference between the sample and the reference cells (ΔT_{-1}) and also between each cell and the adiabatic jacket (ΔT_{-2}). As long as the reaction is being developed, ΔT_{-1} value decreases to zero with the heating of the sample cell (if the reaction is endothermic) or the reference cell (if exothermic). This heating generates a spike over the baseline of the stationary power, and the integration of this potential required to get ΔT_{-1} to zero in the time to recover the equilibrium is the heat of each injection (right panel in Figure 8).

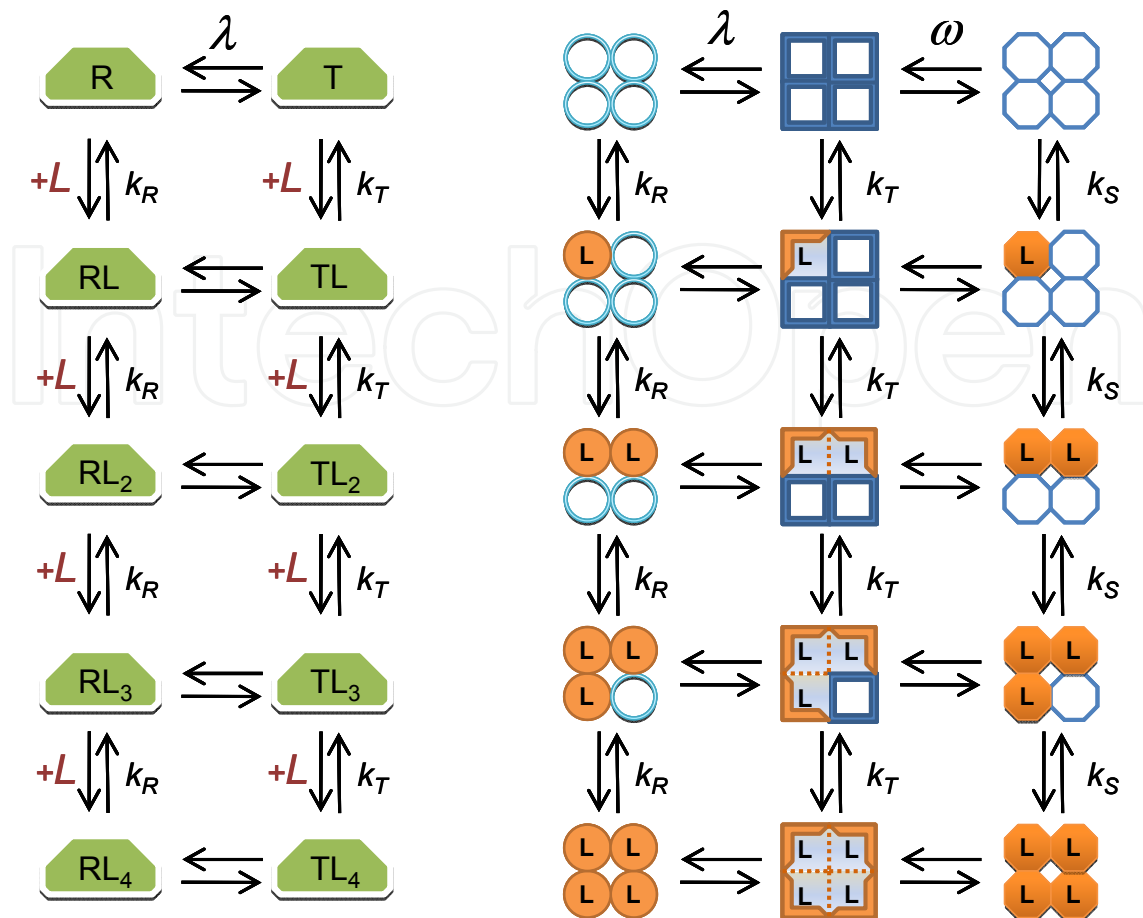

The two schemes show the equilibria for a hypothetical macromolecule displaying four cooperative binding sites for the ligand and one (left) or two (right) different conformational changes.

Figure 7. The Monod-Wyman-Changeux model of binding cooperativity

As we stated above, a typical ITC experiment consists of a series of injections of determined ligand solution volumes, which can be equal or variable each time, into a macromolecule solution. Such injections have to be separated in between by a time interval, large enough to be sure that the system has reached the equilibrium and all heat absorbed or emitted has been transferred. The titration process is continued until saturation of the macromolecule by the ligand into the cell is reached. In this way, the last additions will not give a significant heat exchange, as shown in Figure 8. The final thermogram is obtained by the individual integration of each peak, setting the integration limits in the baseline that precedes and continues such peak with the equation:

$$Q = \int_{t_i}^{t_f} W(t) \cdot dt \quad (34)$$

3.1. Procedures for ITC experiments

As we have mentioned previously, this technique allows us to directly evaluate the heat exchange generated upon binding of two molecules. The correct performance of a titration

experiment has to consider two main aspects, first, the samples preparation and, second, the proper measurement of reaction heats in the calorimeter. In this Section we are going to describe both experimental aspects.

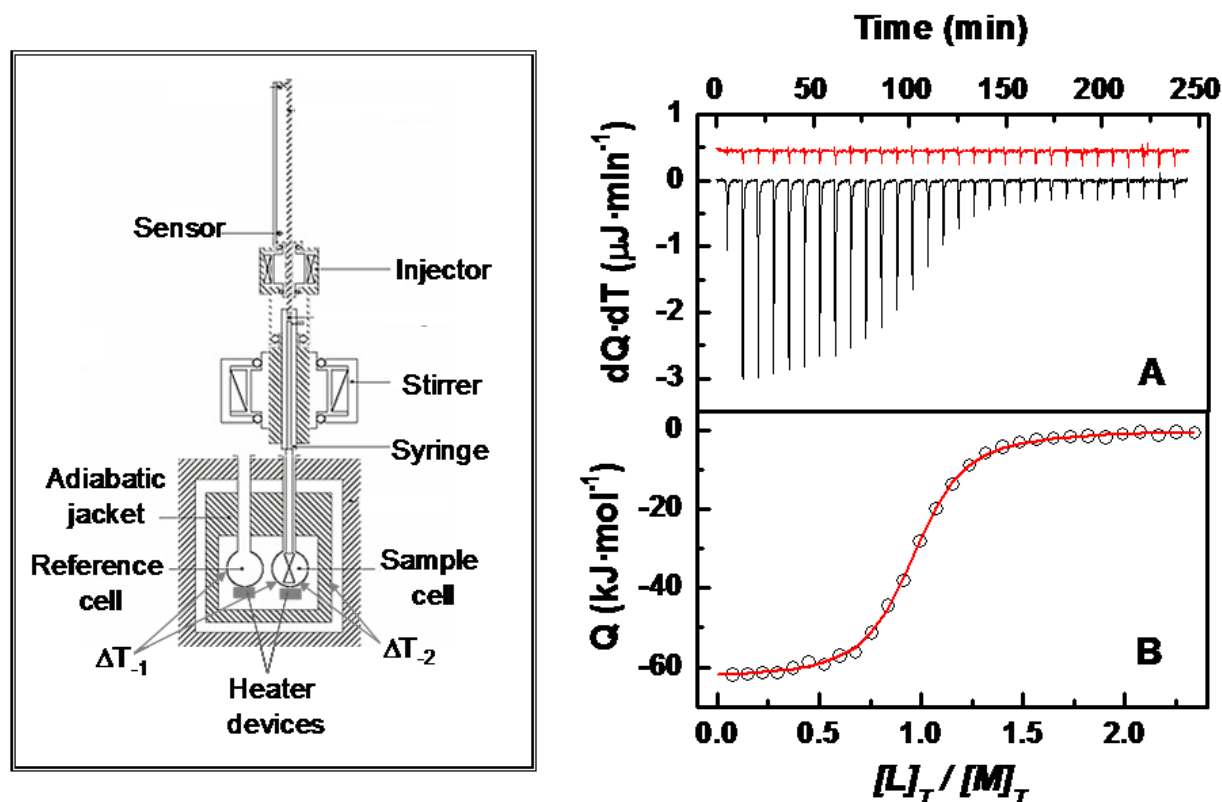

Left side: a schematic diagram of the main components of a titration calorimeter. Right side: a titration calorimetry experiment of a protein with a ligand. In panel A) the titration thermogram is represented as heat per unit of time released after each injection of the ligand into the protein (black), as well as the dilution of ligand into buffer (red). In panel B) the dependence of released heat in each injection *versus* the ratio between total ligand concentration and total protein concentration is represented. Circles represent experimental data and the line corresponds to the best fitting to a model considering n identical and independent sites.

Figure 8. Isothermal titration calorimetry instrumentation

3.1.1. Sample preparation

To carry out ITC binding studies the protein must be of higher purity than 95%, and dialyzed against a selected buffer. Moreover, it is recommended to use the buffer solution of the last dialysis change as the reference solution. The process and precautions to prepare the ligand solution are the same as those described for the protein solution. Nevertheless, when ligands are small as is not possible to dialyze them, the lyophilized (solid) ligand can be directly dissolved with the last dialysis change buffer used for protein sample preparation. As an alternative way, and in order to minimize the differences in the composition of solutions of protein and ligand, lyophilized and solid samples (usually the low molecular weight ligands) can be dissolved in Milli-Q water at a double concentration than that required in the experiment, as well as the protein solution. Accordingly, the dialysis buffer and the protein solution may also contain twice the concentration of buffering salts desired

in the experiment (2x buffer). The experimental solutions of protein, ligand and reference buffer (1x buffer) are prepared by adding to the protein and ligand solutions in the necessary amounts (1:1 dilution) of 2x buffer from the last change of dialysis and Milli-Q water respectively, following the subsequent pH correction of both solutions.

The three solutions (buffer, protein and ligand) have to be centrifuged and/or filtered prior to filling the calorimetric cells in order to avoid insoluble particles, it is also recommended to degas them in order to avoid bubbles. The exact protein concentration of the solution has to be determined just before filling the calorimetric sample cell. One of the most accurate and used methods is the spectrophotometric one using protein extinction coefficients (described by Gill & von Hippel [12]).

3.1.2. Modeling and performance of an ITC experiment

Once the protein solution is in the calorimetric cell and the ligand solution in the ITC syringe (where no air bubbles are present), it is very important to wait enough time to be sure that everything is properly thermostated; a way to control such thermal equilibration is controlling the signal of the ITC instrument. Once the signal of the ITC is stable, the experiment is ready to start with the series of ligand injections.

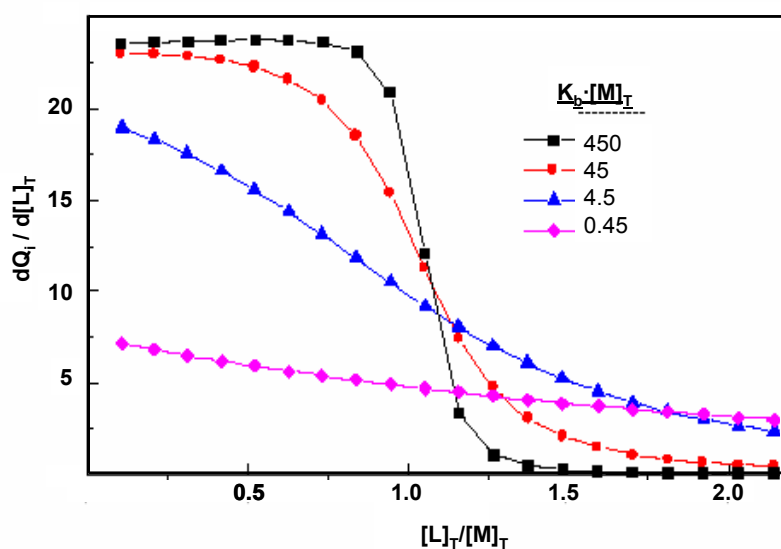

Simulation of heat per added mole of ligand associated to each injection for an ITC experiment with the following experimental parameters: $V_c = 1.347$ mL; $[M]_T = 1.8 \times 10^{-4} \text{ M}^{-1}$ in the cell; 20 injections of $5 \mu\text{L}$; $[L]_T = 5 \text{ mM}$ in the syringe; one binding site and four different values of the association constant, 2.5×10^6 , 2.5×10^5 , 2.5×10^4 and $2.5 \times 10^3 \text{ M}^{-1}$.

Figure 9. Simulations in isothermal titration calorimetry

The limits of a correct determination of the binding thermodynamic parameters using this technique are given by the product of the binding constant, K_b , and the total concentration of the macromolecule, $[M]_T$, being $1 < K_b \cdot [M]_T < 1000$ [11]. Different simulations of a conventional ITC experiment with additions of equal volumes in which four different binding constants have been considered, $2.5 \cdot 10^6$, $2.5 \cdot 10^5$, $2.5 \cdot 10^4$ and $2.5 \cdot 10^3 \text{ M}^{-1}$, are shown in Figure 9. These values are in the range that includes both high and low affinity (the product

$K_b \cdot [M]_T$ ranges from 450 to 0.45). As it can be observed, when the product $K_b \cdot [M]_T$ is within the appropriate range, the sigmoid curve is obtained, which is needed to perform an analysis with acceptable standard errors. When the product $K_b \cdot [M]_T$ is close to the limits, the isotherm can be optimized with some variations of the experimental design, such as the concentration of total macromolecule in the cell or ligand in the syringe, or also by designing profiles of different injected volumes of ligand. Such profiles usually start with lower ligand volumes for the first injections, which increase progressively in a nonlinear way. Another advantage of using an optimal injection volume profile is the increase of the signal/noise ratio at the end of the thermogram, where the heats of binding are quite small. When the product $K_b \cdot [M]_T$ is over the range, titration experiments by displacement can be performed, in which the target ligand competes for the same binding site with another ligand whose interaction has been previously characterized [13-15].

3.2. Previous treatment of ITC experimental data for thermodynamic analysis

Once the ITC experiment has been performed (black titration in panel A of Figure 8), the thermogram can be integrated to obtain the corresponding heats of each injection. Nevertheless, in order to correct the dilution heat effect of the ligand it is necessary to make a baseline ITC experiment (red titration in panel A of Figure 8), which consist of performing an identical ITC experiment of the ligand binding but with buffer instead of protein into the calorimetric cell. Then, the heats for each injection obtained in this baseline experiment are subtracted to the corresponding ones to the ligand binding experiment. Afterwards, we have to normalize the obtained net heats by the total concentration of ligand in the cell after each injection. The binding isotherm can be obtained by the representation of transferred heat per added mole of ligand ($dQ_i/dL_{T,i}$) versus the molar fraction ($[L]_T/[M]_T$) (panel B in Figure 8).

3.3. Corrections to possible additional heat contributions to the binding experiment

The fitting of the experimental data to the equations explained in the next Section, will allow us to obtain, besides the binding constant or the Gibbs energy, the binding enthalpy. Sometimes this enthalpy change obtained from the fittings of experimental data is the result of additional events occurring during the ligand binding process. So it is important to distinguish between the apparent binding enthalpy, ΔH_{app} , and the real or intrinsic binding enthalpy, ΔH_{int} .

One of the possible events associated to the ligand binding process can be a conformational change of the protein and/or the ligand not associated uniquely to the interaction. A typical example is when the free protein is partially denatured at the experimental temperature, so it is important to check the folding of the protein using other techniques, as circular dichroism or differential scanning calorimetry.

Another possibility is that the ligand binding to the protein can be associated to a change in the pK_a of ionisable groups of the protein or/and the ligand [16-18], in such a way that:

$$\Delta H_{app} = \Delta H_{int} + n_p \cdot \Delta H_{ion} \quad (35)$$

where n_p is the number of protons accepted or liberated due to the ligand binding to the protein and ΔH_{ion} is the ionization enthalpy of the buffer used in the experiment. As ΔH_{app} depends on the buffer used and the working pH, the easiest way to determine ΔH_{int} is to perform several ITC experiments under the same conditions (mainly at the same pH and ionic strength), but using buffers of different ΔH_{ion} , which permits the determination of the net binding enthalpy from the ordinate of the corresponding linear correlation of ΔH_{app} versus ΔH_{ion} , i.e., the enthalpy value without buffer ionization contributions ΔH_{int} .

4. Thermodynamic analysis of ITC experiments by using different equilibrium models

The analysis of the isotherms is done by the non-linear fitting of the experimental data using different equations, depending on the way the ligand binds to the macromolecule. In this Section we are going to describe, as an example, the four most common models in the literature. The fittings can be done with the appropriate software, as Origin 7.0 (Microcal Software Inc.) or SigmaPlot 2000 (Jandel Co.).

4.1. Ligand binding to one macromolecule with n identical and independent sites

Although the mathematical formulae corresponding to this binding model has been described in Section 2.2.3, we will start defining several functions and parameters. Thus, the binding parameter, \bar{v} , being the relationship between the concentration of bound ligand, $[L]_b$, and the total macromolecule concentration, $[M]_T$, can be the one given in equation 18:

$$\bar{v} = \frac{nk[L]}{1 + k[L]} \quad (36)$$

where k is the microscopic equilibrium constant, which is unique since all binding sites are independent, $[L]$ is the concentration of non-bounded ligand and n is the number of binding sites in the macromolecule.

The heat released or absorbed in any ITC injection, q_i , is related to the binding process as

$$q_i = \Delta H_{app} \left(\frac{kJ}{molL_b} \right) \Delta(\text{moles}L_b) \quad (37)$$

where ΔH_{app} is the apparent enthalpy change per mole of bound ligand, and $\Delta(\text{moles}L_b)$ is the molar amount of ligand bounded in the injection i . If we express the moles of ligand bound in terms of concentrations, the above equation can be written as:

$$q_i = \Delta H_{app} \cdot V_C \cdot ([L]_{b,i} - [L]_{b,i-1}) = \Delta H_{app} \cdot V_C \cdot (\bar{v}_i \cdot [M]_{T,i} - \bar{v}_{i-1} \cdot [M]_{T,i-1}) \quad (38)$$

where V_c represents the effective volume of the ITC cell and $[M]_T$ is the total concentration of the protein in the cell at injection i .

Furthermore, as known parameters the effective volume of the ITC cell, V_c , the injection volume, V_{inj} , and the ligand concentration in the syringe, $[L]_0$, we can express the concentrations of macromolecule, $[M]_{T,i}$, and ligand, $[L]_{T,i}$, at each injection using the equations

$$[M]_{T,i} = [M]_{T,i-1} \frac{V_c - V_{inj}}{V_c} \quad [L]_{T,i} = \frac{(V_c - V_{inj}) \cdot [L]_{T,i-1} + V_{inj} \cdot [L]_0}{V_c} \quad (39)$$

Thus, the total heat accumulated after N injections could be described as

$$Q = \sum_{i=1}^N q_i = V_c \cdot [M]_T \cdot \Delta H_{app} \cdot \bar{v} = V_c \cdot [M]_T \cdot \Delta H_{app} \cdot \frac{n \cdot K \cdot [L]}{1 + K \cdot [L]} \quad (40)$$

During the ITC experiment the value of the non-bounded ligand concentration, $[L]$, is an unknown variable and for this reason, it is operationally required to estimate it from the experimental variables $[L]_T$ and Q as

$$[L] = [L]_T - [L]_b = [L]_T - \frac{Q}{V_c \cdot \Delta H_{app}} \quad (41)$$

Substituting the above equation in equation 40 we obtain a quadratic equation with Q as unknown variable, whose solution is

$$Q = \frac{V_c \cdot \Delta H_{app}}{2 \cdot k} \left[1 + k \cdot [L]_T + n \cdot k \cdot [M]_T - \sqrt{(1 + k \cdot [L]_T + n \cdot k \cdot [M]_T)^2 - 4 \cdot n \cdot k^2 \cdot [M]_T \cdot [L]_T} \right] \quad (42)$$

Finally, deriving this expression with respect to $[L]_T$ we obtain an expression for the heat per mole of ligand added in each injection

$$\frac{1}{V_c} \cdot \frac{dQ}{d[L]_T} \approx \frac{1}{V_c} \cdot \frac{\Delta Q}{\Delta [L]_T} = \frac{\Delta H_{app}}{2} \left[1 - \frac{1 + [L]_T - n \cdot k \cdot [M]_T}{\sqrt{(1 + k \cdot [L]_T + n \cdot k \cdot [M]_T)^2 - 4 \cdot n \cdot k^2 \cdot [M]_T \cdot [L]_T}} \right] \quad (43)$$

According to these equations, there are two possible ways to analyze the experimental heats from an ITC experiment: one by using equation 43 which considers the heat per mole of added ligand associated with each injection; the second by using equation 42 and considering the total heat accumulated from the beginning to each injection of the ITC experiment. The first approach has the advantage of avoiding experimental errors, since in such analysis is possible to eliminate individual experimental points from the curve (Figure 8), while the second approach imply the sum of all the heats of each injection which accumulates errors.

4.2. Ligand binding to one macromolecule with m different and independent classes of sites

In this model, each binding site is defined as an independent site, with different affinity to the other binding sites. The expression "different sites" implies a microscopic equilibrium constant for each binding site, and the term "independent" site means that the binding affinity does not change with the binding of any other ligand to the other sites of the macromolecule. The mathematical formulae that we describe here correspond to a macromolecule with only two different classes of sites ($m = 2$) with n_1 and n_2 sites for each type, as represented in the following scheme:

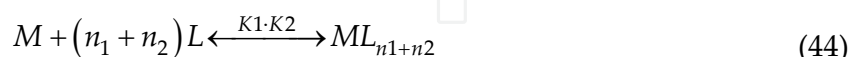

The binding parameter, defined as the ratio of the concentration of ligand bound at any of the two classes of sites, $[L]_{b,i}$, and the total concentration of macromolecule, $[M]_T$, can be expressed now as

$$\bar{\nu} = \sum_{i=1}^{m=2} \nu_i = \frac{[L]_{b,i}}{[M]_T} = \sum_{i=1}^{m=2} \frac{n_i \cdot K_i \cdot [L]}{1 + K_i \cdot [L]} \quad (45)$$

Thus, the heat released or absorbed in any injection, q_j , would be

$$q_j = \sum_{i=1}^{m=2} \Delta H_{app,i} \left(\frac{kJ}{mol L_{b,i}} \right) \cdot \Delta(\text{moles } L_{b,i}) \quad (46)$$

where $\Delta H_{app,i}$ is the apparent enthalpy change per mole of ligand bound to any of the two classes of sites. If we express the moles of ligand bound in terms of concentrations, then the above equation can be re-formulated as:

$$q_j = \sum_{i=1}^{m=2} \Delta H_{app,i} \cdot V_c \cdot ([L]_{b,i,j} - [L]_{b,i,j-1}) = \sum_{i=1}^{m=2} \Delta H_{app,i} \cdot V_c \cdot (\bar{\nu}_j \cdot [M]_{T,j} - \bar{\nu}_{j-1} \cdot [M]_{T,j-1}) \quad (47)$$

where V_c represents the effective volume of the ITC cell and $[M]_{T,j}$ is the concentration of protein in the cell after injection j .

Thus, if we substitute equations 39 in the above expression, we obtain the following:

$$Q = \sum_{j=1}^N q_j = V_c \cdot [M]_T \cdot \sum_{i=1}^{m=2} \Delta H_{app,i} \cdot \bar{\nu}_{i,N} = V_c \cdot [M]_T \cdot \sum_{i=1}^{m=2} \Delta H_{app,i} \frac{n_i \cdot k_i \cdot [L]}{1 + k_i \cdot [L]} \quad (48)$$

Solving the summation for two classes of sites, $m=2$, the expression of the total heat accumulated in N injections can be re-written as

$$Q = V_c \cdot [M]_T \left[\Delta H_{app,1} \frac{n_1 \cdot k_1 \cdot [L]}{1 + k_1 \cdot [L]} + \Delta H_{app,2} \frac{n_2 \cdot k_2 \cdot [L]}{1 + k_2 \cdot [L]} \right] \quad (49)$$

Since the value of $[L]$ is unknown, we should express it in terms of total bound ligand ($[L]_{b,T} = [\nu_1 + \nu_2] \cdot [M]_T$), as we show in the following equation

$$[L] = [L]_T - [L]_{b,T} = [L]_T - [M]_T \cdot \left[\frac{n_1 \cdot k_1 \cdot [L]}{1 + k_1 \cdot [L]} + \frac{n_2 \cdot k_2 \cdot [L]}{1 + k_2 \cdot [L]} \right] \quad (50)$$

Substituting the previous expression in the equation 49 and re-organizing it, we obtain the following cubic equation:

$$[L]^3 + a_2 [L]^2 + a_1 [L] + a_0 = 0 \quad (51)$$

where the coefficients a_0 , a_1 and a_2 are defined as

$$\begin{aligned} a_0 &= -\frac{[L_T]}{k_1 k_2} \\ a_1 &= \left(\frac{n_1}{k_2} + \frac{n_2}{k_1} \right) [M_T] - \left(\frac{1}{k_1} + \frac{1}{k_2} \right) [L_T] + \frac{1}{k_1 k_2} \\ a_2 &= \frac{1}{k_1} + \frac{1}{k_2} + (n_1 + n_2) [M_T] - [L_T] \end{aligned} \quad (52)$$

The only valid solution to the cubic equation 51 can be simply written by just grouping the coefficients a_0 , a_1 and a_2 in three new coefficients A , B and C as

$$[L] = \sqrt[3]{A + \sqrt{A^2 + B^3}} + \sqrt[3]{A - \sqrt{A^2 + B^3}} + C \quad (53)$$

where A , B and C are

$$A = \frac{-a_2^3}{27} + \frac{a_1 a_2}{6} - \frac{a_0}{2} \quad B = \left(\frac{a_1}{3} - \frac{a_2^2}{9} \right) \quad C = -\frac{a_2}{3} \quad (54)$$

The solution of the cubic equation (using equations 52 to 54) allows us to calculate the non-bounded ligand concentration for a given number of injections. Substituting in equation 49, we can determine the heat associated to each injection using the following expression:

$$dQ \approx \Delta Q(j) = Q_T(j) - Q_T(j-1) + \frac{V_{in}}{V_C} \left(\frac{Q_T(j) + Q_T(j-1)}{2} \right) \quad (55)$$

4.3. Ligand binding by the displacement of another ligand in the single binding site of a macromolecule

To formulate this binding model of displacement, we assume two ligands, A and B, which can bind to the same binding site of a protein, M, with different affinity constants. Then, we can describe the equilibrium binding for each ligand as:

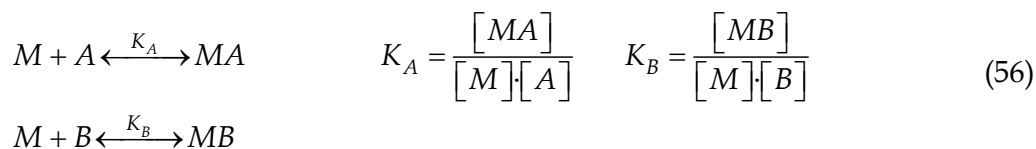

Because the binding of two ligands takes place in the same binding site of the macromolecule, and having the ligand A tighter affinity than ligand B , $K_A \gg K_B$, we should consider the following scheme



According to the schemes 56 and 57 we can express the initial concentration of the ligands A and B as

$$[A]_0 = [MA] + [A] \quad [B]_0 = [MB] + [B] \quad (58)$$

Substituting these expressions in equations 56, the association constants can be re-written as

$$[MA] = \frac{[M] \cdot [A]_0}{1/K_A + [M]} \quad [MB] = \frac{[M] \cdot [B]_0}{1/K_B + [M]} \quad (59)$$

It is important to consider that in the case we propose for this binding model, it is usual that the binding of the high-affinity ligand A has been previously analyzed in a simple titration experiment. The displacement titration experiment will allow us to analyze the interaction of the low affinity ligand B , which cannot be determined by direct titration experiments. Thus, initially, the macromolecule M is bounded to ligand B forming the MB complex and during the titration of the ligand A we will shift partially the MB complex formation to the formation of the MA complex.

For the mathematical formulae of this model, we first define the molar fractions of all species containing the macromolecule. Such fractions are

$$x_M = [M]/[M]_T \quad x_{MA} = [MA]/[M]_T \quad x_{MB} = [MB]/[M]_T \quad (60)$$

where $[M]_T$ is the total concentration of macromolecule.

If we also write the molar ratios between the initial amounts of A and B relative to the total macromolecule concentration as

$$r_A = [A]_0/[M]_T \quad r_B = [B]_0/[M]_T \quad (61)$$

we can write the concentrations of A and B bounded ligands during the interaction as products of the association constants

$$c_A = K_A \cdot [M]_T \quad c_B = K_B \cdot [M]_T \quad (62)$$

Then, substituting these expressions in equations 59, we obtain the following equations for all the species that form the macromolecule, expressed in terms of the molar ratios of macromolecule:

$$x_M + x_{MA} + x_{MB} = 1 \quad x_{MA} = \frac{r_A \cdot x_M}{1/c_A + x_M} \quad x_{MB} = \frac{r_B \cdot x_M}{1/c_B + x_M} \quad (63)$$

Substituting the above equations of x_{MA} and x_{MB} into the first one and rearranging, we obtain the following cubic equation:

$$x_M^3 + a \cdot x_M^2 + b \cdot x_M + c = 0 \quad (64)$$

in which we have defined the a , b and c coefficients as:

$$a = \frac{1}{c_A} + \frac{1}{c_B} + r_A + r_B - 1 \quad b = \frac{r_A - 1}{c_A} + \frac{r_B - 1}{c_B} + \frac{1}{c_A \cdot c_B} \quad c = -\frac{1}{c_A \cdot c_B} \quad (65)$$

Solving such cubic equation, we obtain the following real solution for the molar fraction of macromolecule:

$$x_M = \frac{2 \cdot (\sqrt{a^2 - 3b}) \cdot \cos(\phi / 3) - a}{3} \quad (66)$$

in which the coefficient ϕ can be written as:

$$\phi = \arccos \frac{-2 \cdot a^3 - 9 \cdot a \cdot b - 27 \cdot c}{2 \cdot (\sqrt{a^2 - 3b})^3} \quad (67)$$

Once the molar fraction of free macromolecule, x_M , is determined, we can also know the molar fractions of the other species in which the macromolecule is present (x_{MA} and x_{MB}) by solving the equations 63.

The heat released or absorbed after each injection is proportional to the changes in concentration of MA and MB, $[MA]$ and $[MB]$, and their molar enthalpies of binding. Therefore, the heat after each injection can be written according to the following expression

$$\Delta Q = V_c \cdot (\Delta H_A \cdot \Delta [MA] + \Delta H_B \cdot \Delta [MB]) = V_c \cdot [M]_T \cdot (\Delta H_A \cdot \Delta x_{MA} + \Delta H_B \cdot \Delta x_{MB}) \quad (68)$$

where V_c is the effective volume of the ITC cell. To correct the concentrations of macromolecule and ligand, we define the following infinitesimal change for their concentrations

$$d[X] = -\frac{dV_i}{V_0} \cdot [X] \quad (69)$$

where $[X]$ represents the concentration of any species. Integrating the above expression between the limits from $[X]_i$ to $[X]_{i-1}$ and from zero to V_i . The resulting equation is

$$[X]_i = [X]_{i-1} \exp\left(-\frac{V_i}{V_0}\right) = [X]_{i-1} f_i \quad (70)$$

where f_i is the dilution factor that allow us to define the molar ratios after each injection as

$$[A]_i = [A]_{i-1}(1 - f_i) \quad [M]_i = f_i[M]_{i-1} \quad [B]_i = f_i[B]_{i-1} \quad (71)$$

Consequently, the heat absorbed or released after each injection can be expressed as

$$dQ \approx \Delta Q = V_c [M]_T \cdot \{ \Delta H_A \cdot (\Delta x_{MA,i} - f_i \cdot x_{MA,i-1}) + \Delta H_B \cdot (\Delta x_{MB,i} - f_i \cdot x_{MB,i-1}) \} \quad (72)$$

4.4. Ligand binding to a macromolecule with two dependent (cooperative) binding sites

The scheme described in Figure 2 for a macromolecule with two binding sites was used in Section 2.2.2 to describe the correlation between macroscopic and microscopic equilibrium constants and the binding parameter was obtained for the case of independent sites, characterized by the same microscopic constant. Nevertheless, when cooperativity exists among sites, this simple assumption cannot be considered, and more than one value for such constants must be taken into account. Thus, positive cooperativity would be revealed when $k_3 > k_1$ and $k_4 > k_2$, and the opposite is true for negative cooperativity. In any case, it can be easily deduced that $k_3 \cdot k_1 = k_4 \cdot k_2$.

The most simplified version of this model could be attained for equivalent binding sites, that is, when microscopic binding to the first site is identical, independently if the ligand binds to either site 1 or 2. The occupancy of the first site will drive to the modification of the affinity of the second one, in a similar way in both branches of the scheme. Therefore, $k_1 = k_2$ and $k_3 = k_4$. In parallel, the enthalpy changes associated can be also grouped in only two different values, the changes for the formation of ML and ML_2 species respectively. From here, any other version should be much more complicated from a mathematical point of view. Overcoming these calculation matters, the solution can be achieved in a similar way to the described here for the simplest version, which is also inspired in the models described previously.

The molar fractions of all species containing the macromolecule are in this case

$$x_{ML} = \frac{[ML]}{[M] + 2[ML] + [ML_2]} = \frac{k_A [L]}{1 + 2k_A [L] + k_A k_B [L]^2} \quad (73)$$

$$x_{ML_2} = \frac{[ML_2]}{[M] + 2[ML] + [ML_2]} = \frac{k_A k_B [L]^2}{1 + 2k_A [L] + k_A k_B [L]^2}$$

where we have assumed that $k_1 = k_2 = k_A$ and $k_3 = k_4 = k_B$.

Taking into account the equation 40, the total heat accumulated after N injections could be described as

$$Q = \sum_{i=1}^N q_i = V_c [M]_T \cdot \Delta H_{app} \cdot \bar{v} = V_c [M]_T \cdot \{ x_{ML} (\Delta H_A + \Delta H_B) + x_{ML_2} (\Delta H_A + \Delta H_B) \} \quad (74)$$

where ΔH_A and ΔH_B are the enthalpy changes associated to equilibriums characterized by k_A and k_B respectively. Since the value of $[L]$ is unknown, we should express it in terms of total ligand ($[L]_T = [L] + 2[ML] + 2[ML_2]$), as we show in the following equation

$$[L] = [L]_T - 2 \cdot x_{ML} [M]_T - 2 \cdot x_{ML_2} [M]_T \quad (75)$$

This can be expressed as the following third-order equation:

$$[L]^3 + a_2 [L]^2 + a_1 [L] + a_0 = 0 \quad (76)$$

where the coefficients a_0 , a_1 and a_2 are defined as

$$a_0 = -\frac{[L]_T}{k_A k_B} \quad a_1 = \frac{2}{k_B} [M]_T - \frac{2}{k_B} [L]_T + \frac{1}{k_A k_B} \quad a_2 = \frac{2}{k_B} + 2[M]_T - [L]_T \quad (77)$$

The only valid solution to the cubic equation above can be simply written by grouping the coefficients a_0 , a_1 and a_2 in three new coefficients A , B and C as follows:

$$[L] = \sqrt[3]{A + \sqrt{A^2 + B^3}} + \sqrt[3]{A - \sqrt{A^2 + B^3}} + C \quad (78)$$

where A , B and C are

$$A = \frac{-a_2^3}{27} + \frac{a_1 a_2}{6} - \frac{a_0}{2} \quad B = \left(\frac{a_1}{3} - \frac{a_2^2}{9} \right) \quad C = -\frac{a_2}{3} \quad (79)$$

The solution of the cubic equation (using equations 77 to 79) allows us to calculate the non bounded ligand concentration for a given number of injections. Substituting in equation 74, we can determine the heat associated to each injection using the following expression:

$$dQ \approx \Delta Q(j) = Q_T(j) - Q_T(j-1) + \frac{V_{in}}{V_C} \left(\frac{Q_T(j) + Q_T(j-1)}{2} \right) \quad (80)$$

4.5. Guidelines for the development of ITC equilibrium models

Following the reasoning given in this Chapter, it is easy to discern the basic rules to build any ITC model. The main point would be to collect any experimental and structural evidence (number of sites in the macromolecule M for ligand L , their dependent or independent character, etc) to develop the basic interaction scheme. This scheme will drive to the construction of the binding polynomial, Z , which derives into the binding parameter, $\bar{\nu}$, as it has been described in detail into Section 2.

The examples given into Section 4 for the most common ITC models used reveal that, once the model is described in terms of the binding parameter or by the molar fractions of all species containing the macromolecule, two basic points have to be solved from a

mathematical point of view. That is, the total heat accumulated after N injections as a function of the binding parameter (equation 40) and the concentration of free ligand as a function of the well-known total concentrations of macromolecule and ligand. Both solutions can be replaced into an equation such as 80 to determine the heat associated to each injection.

These heats divided by the number of moles of ligand added represent the dependent variable of the curve fitting analysis (dQ_i/dL_i), where the ratio between the total concentrations of ligand and macromolecule $[L]_T/[M]_T$ represents the independent variable of the fitting function. The results of this non-linear regression analysis provide the values of the equilibrium constants and the respective enthalpy changes involved in such equilibriums, according to the proposed model. An example is illustrated in Figure 8.

Author details

Jose C. Martinez, Javier Murciano-Calles, Eva S. Cobos, Manuel Iglesias-Bexiga, Irene Luque and Javier Ruiz-Sanz
Department of Physical Chemistry and Institute of Biotechnology, Faculty of Sciences, University of Granada, Granada, Spain

Acknowledgement

This work was financed by grant CVI-5915 from the Andalusian Regional Government (Spain), grant BIO2009-13261-C02-01 from the Spanish Ministry of Science and Technology, FEDER and Plan E.

5. References

- [1] Langerman N & Biltonen RL (1979) Microcalorimeters for biological chemistry: applications, instrumentation and experimental design. *Methods Enzymol* 61: 261-286.
- [2] Biltonen RL & Langerman N (1979) Microcalorimetry for biological chemistry: experimental design, data analysis, and interpretation. *Methods Enzymol* 61: 287-318.
- [3] Wyman J (1965) Binding Potential a Neglected Linkage Concept. *Journal of Molecular Biology* 11: 631-&.
- [4] Hess VL & Szabo A (1979) Ligand-Binding to Macromolecules - Allosteric and Sequential Models of Cooperativity. *Journal of Chemical Education* 56: 289-293.
- [5] Szabo A & Karplus M (1972) Mathematical-Model for Structure-Function Relations in Hemoglobin. *Journal of Molecular Biology* 72: 163-&.
- [6] Szabo A & Karplus M (1975) Analysis of cooperativity in hemoglobin. Valency hybrids, oxidation, and methemoglobin replacement reactions. *Biochemistry* 14: 931-940.
- [7] Szabo A & Karplus M (1976) Analysis of Interaction of Organic-Phosphates with Hemoglobin. *Biochemistry* 15: 2869-2877.
- [8] Pauling L (1935) The Oxygen Equilibrium of Hemoglobin and Its Structural Interpretation. *Proc Natl Acad Sci U S A* 21: 186-191.

- [9] Cuadri-Tome C, Baron C, Jara-Perez V, Parody-Morreale A, Martinez JC & Camara-Artigas A (2006) Kinetic analysis and modelling of the allosteric behaviour of liver and muscle glycogen phosphorylases. *J Mol Recognit* 19: 451-457, doi: 10.1002/jmr.772.
- [10] Ladbury JE & Chowdhry BZ (1996) Sensing the heat: the application of isothermal titration calorimetry to thermodynamic studies of biomolecular interactions. *Chem Biol* 3: 791-801.
- [11] Wiseman T, Williston S, Brandts JF & Lin LN (1989) Rapid measurement of binding constants and heats of binding using a new titration calorimeter. *Anal Biochem* 179: 131-137.
- [12] Gill SC & von Hippel PH (1989) Calculation of protein extinction coefficients from amino acid sequence data. *Anal Biochem* 182: 319-326.
- [13] Sigurskjold BW (2000) Exact analysis of competition ligand binding by displacement isothermal titration calorimetry. *Anal Biochem* 277: 260-266, doi: 10.1006/abio.1999.4402S0003-2697(99)94402-0 [pii].
- [14] Velazquez-Campoy A & Freire E (2006) Isothermal titration calorimetry to determine association constants for high-affinity ligands. *Nat Protoc* 1: 186-191, doi: nprot.2006.28 [pii]10.1038/nprot.2006.28.
- [15] Zhang YL & Zhang ZY (1998) Low-affinity binding determined by titration calorimetry using a high-affinity coupling ligand: a thermodynamic study of ligand binding to protein tyrosine phosphatase 1B. *Anal Biochem* 261: 139-148, doi: S0003-2697(98)92738-5 [pii]10.1006/abio.1998.2738.
- [16] Baker BM & Murphy KP (1996) Evaluation of linked protonation effects in protein binding reactions using isothermal titration calorimetry. *Biophysical Journal* 71: 2049-2055.
- [17] Mason AC & Jensen JH (2008) Protein-protein binding is often associated with changes in protonation state. *Proteins-Structure Function and Bioinformatics* 71: 81-91, doi: Doi 10.1002/Prot.21657.
- [18] Velazquez-Campoy A, Luque I, Todd MJ, Milutinovich M, Kiso Y & Freire E (2000) Thermodynamic dissection of the binding energetics of KNI-272, a potent HIV-1 protease inhibitor. *Protein Sci* 9: 1801-1809, doi: 10.1110/ps.9.9.1801.

IntechOpen