

We are IntechOpen, the world's leading publisher of Open Access books Built by scientists, for scientists

4,800

Open access books available

122,000

International authors and editors

135M

Downloads

Our authors are among the

154

Countries delivered to

TOP 1%

most cited scientists

12.2%

Contributors from top 500 universities



WEB OF SCIENCE™

Selection of our books indexed in the Book Citation Index
in Web of Science™ Core Collection (BKCI)

Interested in publishing with us?
Contact book.department@intechopen.com

Numbers displayed above are based on latest data collected.
For more information visit www.intechopen.com



Active Integrated Antenna Design for UWB Applications

Danial Nezhad Malayeri

Additional information is available at the end of the chapter

<http://dx.doi.org/10.5772/50185>

1. Introduction

UWB technology is advancing rapidly because of its potential to have high data rates and very low radiation power. In recent years UWB technology has been used in the areas of, sensing, radar and military communications [1]. In February 2002, the Federal Communications Commission (FCC) of the United States issued a report that UWB could be used for wireless data Communications [2]. Since then, a huge surge of research interests have occurred and this technology has been considered as one of the most reliable wireless technologies for various applications that leads to new innovations and greater quality of wireless personal area network services industry.

Reliable wireless connection between computers, portable devices and consumer electronics in short distances and data storage and transfer between these devices are new subjects of scientific and industrial competitions which require data rates much more than now a day accessible ones.

In this chapter, at the second part, some advantages of ultra-wideband technology and its progress trend will be reviewed. In the third part, antennas structures and parameters, especially wideband antennas will be studied for use in the UWB systems. To describe the performance of an antenna, various parameters must be defined. There are several important and practical parameters such as frequency bandwidth, radiation pattern, directivity, gain and input impedance which will be explained briefly. The performance of a UWB antenna is required to be stable and uniform over the ultra wide operational bandwidth. In the other word, antenna radiation pattern, gain and input impedance should be stable across the entire band. Also antenna needs to be small enough to be compatible with the other UWB system elements, especially in portable devices. In addition, basic antenna parameters, such as gain and return loss, must have little variations across the

operational band. Various methods have been employed to enhancement antenna bandwidth. In this part, frequency independent antennas will be studied for instance.

In part 4, planar spiral antenna characteristics and features will be reviewed as a frequency independent antenna. Since without optimization, spiral antenna has some limitations for UWB applications, these limitations will be improved by using some optimization techniques. One of new methods is using active circuit in antenna structure. So in the fifth part, improving history of active antenna technology will be reviewed. Integration of active circuit into passive antenna gives a lot of advantages such as increasing the effective length of short antennas, increasing bandwidth, improving noise factor, impedance matching and sensitivity of receiver antennas and some applications such as utilizing active antenna arrays in mobile communications and beam control, solving channel capacity limitation problems by increasing data rate and improving smart antenna technologies [3] and many other advantages. Overall active antenna structure and different types and applications will be discussed in this part.

A review of distributed amplifiers characteristics will be done in the sixth part as the active part of active antenna structure. Here the aim is to design a UWB distributed amplifier with uniform and acceptable parameters such as Gain and VSWR in the 3.1- 10.6 GHz band. Calculation of the optimum load resistance and the number of amplifier stages, and then design, optimization and analysis of the circuit must be done for active circuit design completion. Adding antenna element to the active circuit and combined circuit analysis will be explained in this part too. Finally a brief analysis of design and simulation results of UWB active antennas will be shown in the seventh part and it will be favorable that active antenna parameters such as VSWR and Gain are appreciably optimized rather than passive antenna.

2. UWB Technology

UWB systems historically have been based on impulse radio signals; therefore they can communicate at very high data rates by sending pulses rather than using narrow band frequency carriers. The pulses normally have an ultra-wide frequency spectrum caused by short pulse durations which are about nanoseconds. The concept of impulse radios initially was introduced by Marconi, in the 1900s [1], but since 1960s, impulse radio technologies started being developed for radar and military applications.

In February, 2002, the FCC allocated a bandwidth of 7.5GHz, i.e. from 3.1GHz to 10.6GHz for UWB applications [1]. It was the largest spectrum allocation for unlicensed applications that the FCC has ever permitted. According to the FCC's report, any signal that contains at least 500MHz spectrum can be used in UWB systems. It means that UWB applies to any technology that uses 500MHz spectrum and complies with all other requirements for UWB.

Shannon-Nyquist criterion in Equation (1) shows the relation between channel capacity, bandwidth and signal-to-noise ratio (SNR), when channel is assumed to be ideal band-limited with Additive White Gaussian Noise (AWGN):

$$C = BW \log_2 (1 + \text{SNR}) \quad (1)$$

Where C is the maximum data rate and BW is the channel bandwidth. Equation (1) indicates that by increasing the SNR (which is directly related to transmission power) or bandwidth, transmitting data rate can be increased. Because of power limitations, increasing the SNR is not a general solution [2, 3, 4 and 5]. Therefore to increase channel capacity and achieve high data rate, a large frequency bandwidth is needed. Considering Shannon-Nyquist Equation indicates that channel capacity can be increased more rapidly by enhancing the channel bandwidth than the SNR. Thus, the wider frequency range can lead to the greater channel capacity. This is more applicable for WPAN which works over short distances and SNR is more satisfactory there.

2.1. UWB benefits

UWB has many satisfactory advantages which make it an interesting technology for wireless systems. It is probably the most promising technology for new wireless systems because of some advantages such as low complexity, low power consumption, low cost, high data rate and short-distance wireless connectivity. From circuit point of view, accurate power transfer between transmitter and receiver is the major challenge of UWB system design to obtain a flat received power with minimum ripple.

Here some other benefits are reviewed:

- Shannon-Nyquist theorem shows that channel capacity is proportionally related to bandwidth. According to the ultra-wide frequency bandwidth of UWB systems, they can achieve grate capacity in distances below 10 meters [1].
- UWB systems use very low power transmission levels across an ultra-wide frequency spectrum that lead to reducing the effect of power upon each frequency element below the acceptable noise level [1]. This is illustrated in figure (1),

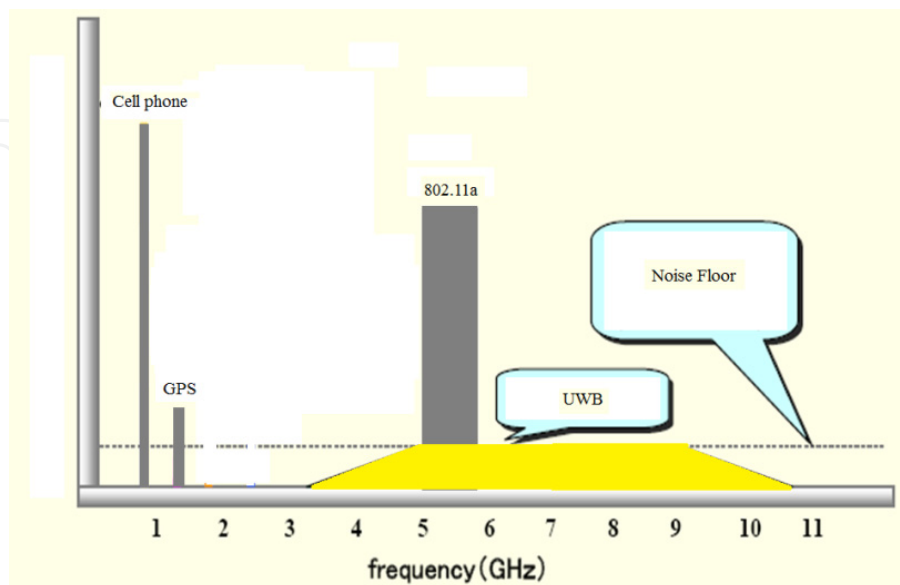

Figure 1. Ultra wideband communications spread transmitting energy

- Because of low energy density of the UWB signal, it is a noise-like signal and therefore its undesirable detection is unlikely. Since it is a noise-like signal which has a particular shape, it can be detected in related receiver. In contrast, real noise has no shape, thus interference cannot distort the pulse shape completely and it can still be recovered to restore primary signal. Hence UWB communications are very secure and reliable means.
- Baseband nature of the UWB signal which is based on impulse radios causes low cost and low complexity of operation systems. Because it does not require system components such as mixers, filters, amplifiers and local oscillators which are necessary for modulation and demodulation units.

Some of the other UWB benefits and advantages are briefly listed below:

- High data transfer rate
- Channel capacity improvement
- Lower power consumption
- Lower cost
- Coexistence possibility with 802.11/b/g
- Accurate position and distance metering
- Improved measurement accuracy of target detection in radar
- Identification of target class and type

And so many other interesting advantages which cannot be explained here. For more information see references [4 and 5].

3. Antenna

A passive antenna is an electrical conductor or array of them which radiates (transmits/ receives) electromagnetic waves. Most antennas are resonant devices, which operate over a relatively narrow frequency band. For any wireless system, antenna is an essential part which must concentrate the radiation energy in some directions at certain frequencies. Thus the antenna is also considered as a directional device too. Depending on application type, antenna must take various shapes to meet the required conditions. Therefore, antenna may be a specific length of a wire, an aperture, a patch and so on. A good designed antenna can improve system performance by complying system requirements.

3.1. Antenna parameters

To discuss the performance of an antenna, various parameters must be defined. Frequency bandwidth, gain, input impedance and radiation pattern are some of them.

Frequency bandwidth; is the range of frequencies which the antenna performance conforms specified characteristics. In other words, the bandwidth is the range of frequencies which the antenna characteristics are acceptable in compare with their values in center frequency. Frequency bandwidth can be expressed in form of absolute bandwidth (Abw) or fractional bandwidth (Fbw). Abw and Fbw can be calculated as given in Equations (2) and (3), respectively:

$$Abw = f_H / f_L \quad (2)$$

$$Fbw = Abw / f_c \quad (3)$$

$$f_c = (f_H + f_L) / 2$$

Where f_H and f_L express the high and low frequencies of the bandwidth respectively and f_c shows the center frequency. Although sometimes the bandwidth is expressed as the ratio of the high to low frequencies of operational bandwidth for broadband antennas:

$$BW = f_H / f_L \quad (4)$$

Radiation Pattern; is the representation of the radiation properties of the antenna as a function of space coordinates. Usually radiation Pattern is determined in the farfield region to avoid effects of the distance on the spatial distribution of the radiated power [1].

The radiation pattern can be expressed in two or three-dimensional spatial distribution and it is usually in normalized form with respect to the maximum values. Radiation properties of an antenna can be described by three types of radiation patterns:

- Isotropic - An ideal lossless antenna with equal radiation in all directions.
- Directional - An antenna with the radiation pattern in some directions significantly greater than the others.
- Omni-directional - An antenna which have a non-directional radiation pattern in one plane and a directional pattern in other orthogonal planes.

Gain and Directivity; directivity is calculated as the ratio of the radiation intensity in a given direction over an isotropic source radiation intensity, to describe the directional radiation properties of an antenna. The directivity is expressed by D letter and can be calculated by equation (5):

$$D = \frac{U}{U_0} \quad (5)$$

$$U_0 = \frac{P_{rad}}{4\pi}$$

Where U_0 is the radiation intensity for an isotropic source, U is radiation intensity of antenna and P_{rad} is radiated power.

Antenna gain is related to the directivity and radiation efficiency and it can be calculated by equation (6):

$$G = e_{rad} D \quad (6)$$

Which G is antenna gain and e_{rad} is radiation efficiency.

3.2. UWB antenna characteristics

Although UWB antenna is an important part of conventional wireless communication systems, but designing a UWB antenna needs to consider important notes that some of them are listed below:

- Because of the ultra-wide frequency bandwidth of these systems and to comply with the FCC report, Abw and Fbw of a UWB antenna should not be less than 500MHz and 0.2 respectively
- UWB antenna parameters such as antenna radiation pattern, gain and input impedance must be uniform and stable over the entire operational band.
- Radiation pattern properties are different depending on the practical conditions which the UWB antenna should meet them.
- In many cases such as portable devices, the UWB antenna should be small enough to be compatible with the overall system. In some other applications this antenna must be compatible with printed circuit board (PCB) structures.
- UWB antenna should comply with the FCC power emission mask or other world regulatory bodies.
- UWB antenna must have minimum effects on UWB pulse waveform.

3.3. Frequency independent antennas

Ultra wide operating bandwidth is the main difference and advantage of a UWB antenna. To achieve wideband characteristics for different antennas, various methods can be used. Frequency independent antennas are one important group of antennas which display wideband features. Some principles and conditions of this group are discussed here.

Frequency independent antennas can display almost uniform input impedance and radiation pattern and other radiation properties over a wide frequency bandwidth. Spiral antenna is one practical example of frequency independent antennas. These antennas were called travelling wave antennas by Johnson Wang at first.

Victor Rumsey in the 1950s and Yasuto Mushiake in the 1940s introduced some principles which explain how frequency independent characteristics can be achieved.

The first principle which is introduced by Rumsey suggests that to achieving frequency independent properties of an antenna, its shape must be specified only by angles [6]. One example for this type of antennas is spiral antenna with no limitation of its length. Infinite biconical antennas are other examples whose shapes are completely described by angles.

Self-complementarity is the second principle of frequency independent characteristics which was introduced by Yasuto Mushiake. This principle suggests that if an antenna is complement of itself, frequency independent behavior is achieved. In such an antenna, impedance is constant and equal to $\eta/2$ or 188.5 Ohms [1].

Although these antennas are theatrically frequency independent, but they are some limitations which cause limited bandwidth of this type of antennas and needs some optimization to achieve unlimited bandwidth.

The first problem is the unlimited dimensions of antenna requirements according to Rumsey's principle. It is impossible to have an infinite length for example in a spiral antenna and the antenna size will be a practical challenge. Truncating each of dimensions of antenna can cause limitations in frequency bandwidth.

Second problem is that spiral antenna active zone depends on the signal frequency. For a UWB signal, there are many frequency components and each frequency component is radiating from different part. In other words the smaller parts radiate higher frequencies and the larger scale parts emit lower frequencies of antenna and this may cause dispersive and signal distortion. Therefore these antennas can cause problems for systems which cannot tolerate dispersion. Signal detection and recovery features are needed for systems which use this type of antennas.

4. Spiral antenna

New generation communication systems requirements have an essential role in identifying the type of antenna which is used with them. High data rate and wider bandwidth requirements for data/video transfer and growth in number of users lead to increased operating frequencies of these systems to microwave and millimeter-wave frequencies. In these frequencies the performance of standard antennas such as monopole and dipole antennas is considerably weak and it causes us to choose planar antennas as a way to surmount this problem. Planar antennas have many benefits such as lower manufacturing costs, considerably smaller size and less weight in comparison with the other antennas. This causes to increase their applications in for example mobile phones and communication stations.

In the other hand, their planar structure makes them desirable for use in large arrays and suitable for integrating with electronic circuits such as amplifiers and phase shifters which are the main parts of designing radar, satellite communications and etc. planar structure gives them the ability of using in some applications such as antennas printed in the airplane body which can resolve limitations of antenna size [7]. These features and many other benefits of this type of antennas caused them to become a good subject of new designs of high performance planar antennas in many different applications and raised a new type of antennas with the name of Active Integrated Antennas (AIA) which will be discussed more in the next parts.

According to previous discussion about frequency independent antennas such as spiral antenna, they are classical wideband antennas which can display uniform impedance and pattern characteristics over a frequency range wider than 10:1. Thus spiral antenna seems to be a good choice for use in UWB active antenna design. So in the following part, spiral antenna and its parameters are discussed in detail.

4.1. Features

Planar spiral antennas are one of frequency independent antennas with wide bandwidth and good pattern efficiency in comparison with other antenna types. Theoretically a spiral

antenna with infinite number of turns and dimensions which confirms the frequency independent principles can exhibit infinite pattern efficiency and bandwidth. But practical infinite arm length is impossible and some limitations must be applied [6, 8]. This type of antennas has widespread usage because of their small substrate size and few pulse dispersions in communicating processes. The primarily used single arm spiral antenna is illustrated in the figure (2). Desirable radiation characteristics can be achieved by changing circular radius r , number of turns N and the width of them W [8].

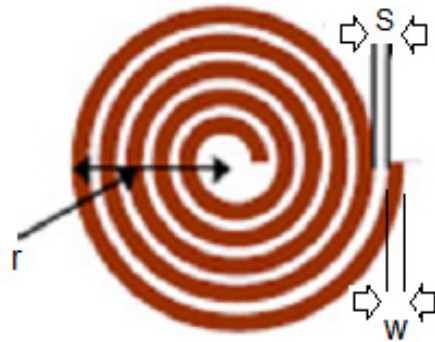

Figure 2. Single arm spiral antenna

If $W = S$, i.e. the metal and the air parts of the antenna are equal, the spiral antenna is self-complementary.

4.2. Active zone

In spiral antenna radiation is done from that part of antenna which its circumference is equal to or greater than 2λ , where λ is the wave length. This region is called active zone of antenna. Thus low frequency limit of antenna is related to exterior radius of antenna as expressed by (7) relation and the high frequency limitation is related to its interior radius. In the other word, circumference of the radiation zone determines the radiation frequency.

$$f = c / \pi r \rightarrow f_{\text{low}} = c / \pi r_2 \quad \text{and} \quad f_{\text{high}} = c / \pi r_1 \quad (7)$$

Where c is the light speed, r_1 is the interior radius and r_2 is the exterior radius of the antenna. In fact, relation shows that higher frequencies are emitted from smaller circles and the lower frequencies will radiate from bigger circles of the antenna. However in practice, because of antennas end reflections and source effects, high and low frequencies will be a little different from the calculated values of relation (7) [8].

According to the previous discussion, active zone calculation is one of important and effective parameters to design a spiral antenna. Radius of radiation circle is defined by relation (7). In fact this region is a part of antenna in which maximum power of the device is radiated from and it can be considered as only radiating zone of antenna.

In this area, current amplitude inducted by radiation is considerably higher than the currents in other parts of structure. The region between source point and the active zone

which has low power emission is called transmission line zone, because it just transfers power from source to load or antenna. Although the final antenna radiation pattern is not considerably affected by this area, it is effective in the value of input impedance and therefore must be considered to have an optimum design. The area between active zone and the end of antenna arm is out of radiation circuit. In fact, whole power is emitted before reach to this area, therefore it has no effect on the radiation pattern and input impedance [8]. So it can be predicted that by increasing frequency, active region will move along spiral antenna radius such a way that electrical dimensions remain constant in different frequencies. To conforming Rumsey's principle, antenna dimensions must be infinite and such antenna can be considered as frequency independent antenna. But by eliminating antenna structure in both ends because of practical manufacturing limitations, antenna performance will be considerably dependent on active zone properties.

To define active zone, at first the lowest frequency of bandwidth must be selected to calculating the exterior radius of active zone. As is discussed, by increasing frequency, active zone will move to interior parts and smaller radiuses. Then by choosing the highest operating frequency of bandwidth, its related active zone and interior structure boundary can be defined. However usually interior radius is not limited more than requirements of implementing power source in center.

Defining active zone has some benefits; because of predefined manufacturing limitations, antenna structure must be limited in both directions and missing a vast width of frequency band. Therefore active zone definition helps designers to design antenna with better performance in the practical frequencies. Another advantage of defining active zone is to understanding and calculating other effective parameters in antenna performance optimization [8].

5. Active antenna

The idea of using active antennas was introduced in about 1928 by using a small antenna with electron tube in radio receivers. In 1960's and 1970's, active antennas were studied more seriously due to the invention of high frequency transistors [9, 10]. Because of progresses in technology of microwave integrated circuit (MIC), active antennas became an interesting subject of researches at that time [11, 12 and 13]. Integration of active device into passive antenna gives a lot of advantages such as increasing the effective length of short antennas, increasing the bandwidth, improving the noise factor, impedance matching and sensitivity of receiver antennas and some applications such as utilizing active antenna arrays in mobile communication and beam control, using to solve channel capacity limitation problems by increasing data rate and improving smart antenna technologies [3] and many other advantages.

5.1. Active antenna structure

Radiation element or passive antenna is a device that converts received signals from a transmission line into electromagnetic waves and radiates them into free space in a

transmitting antenna and vice versa in a receiving one. According to IEEE Standard antenna is a means for radiating or receiving radio waves [1]. Figure (3) shows the conventional receiving configuration of passive and active antennas.

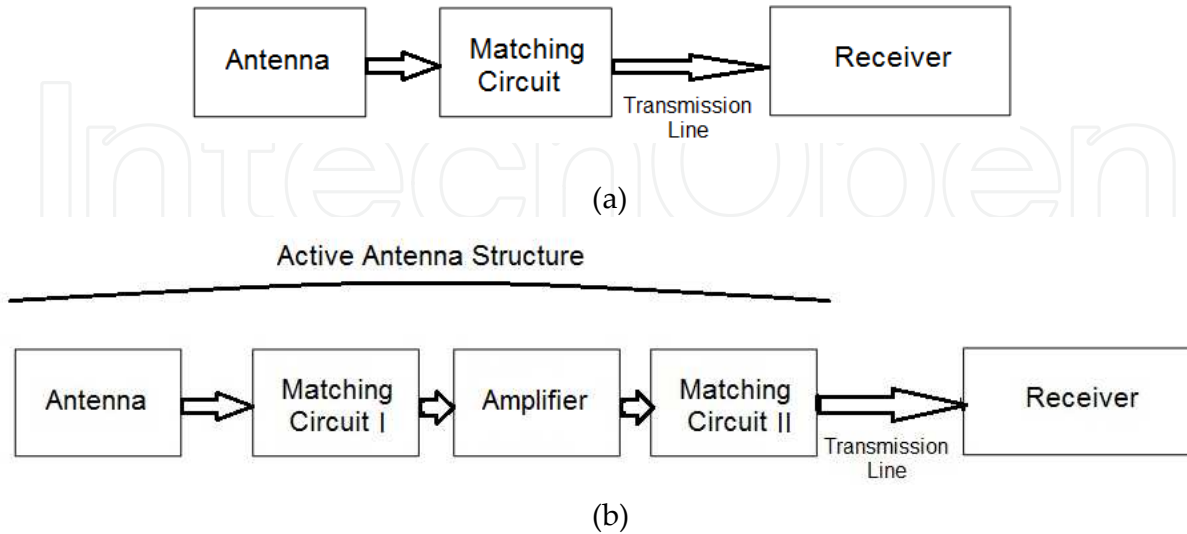

Figure 3. a). Receiving system structure for passive antenna; b). Receiving system structure for active antenna

In 1977, Lindenmeier and Meinke suggested that if the cable length between the antenna and the amplifier is about 1-5 m, the antenna system will be considered as the passive one as shown in Figure (4a). Consequently when the radiating element is closely connected (Integrated) to the active circuit or amplifier, the structure is considered as active antenna [14]. It is important to note that the distance between radiation element and active circuit is related to the operating frequency and electrical length of cable.

As mentioned, the term “active antenna” means that the active device is coupled with the passive antenna to improve antenna performance, while the term “active integrated antenna” expresses more distinctive that the passive antenna element is integrated on the same substrate with the active circuit [9]. From the microwave theory standpoint, an active integrated antenna (AIA) can be regarded as an active circuit which its output or input ports are in free space instead of a conventional 50Ω interface. In this case, the antenna provides certain functions such as resonating, filtering, and duplexing circuit behaviors. But from the antenna theory sight, the AIA is an antenna which exhibits radio signal generating and processing capabilities such as mixing and amplification [15].

In these systems whole systems is working with antenna and controls antenna as well as load parameters. By connecting antenna and circuit in such a way, transmission line losses are reduced considerably. It will be more important when the frequency is growing up [16]. This is significantly different and more effective than the systems in which radiating element and circuit are designed separately and then connected by a strip line or another type of transmission line. This is important to note that when antenna is consisting of a nonreciprocal circuit, it means that AIA system is non-reciprocal unlike passive antenna alone [7].

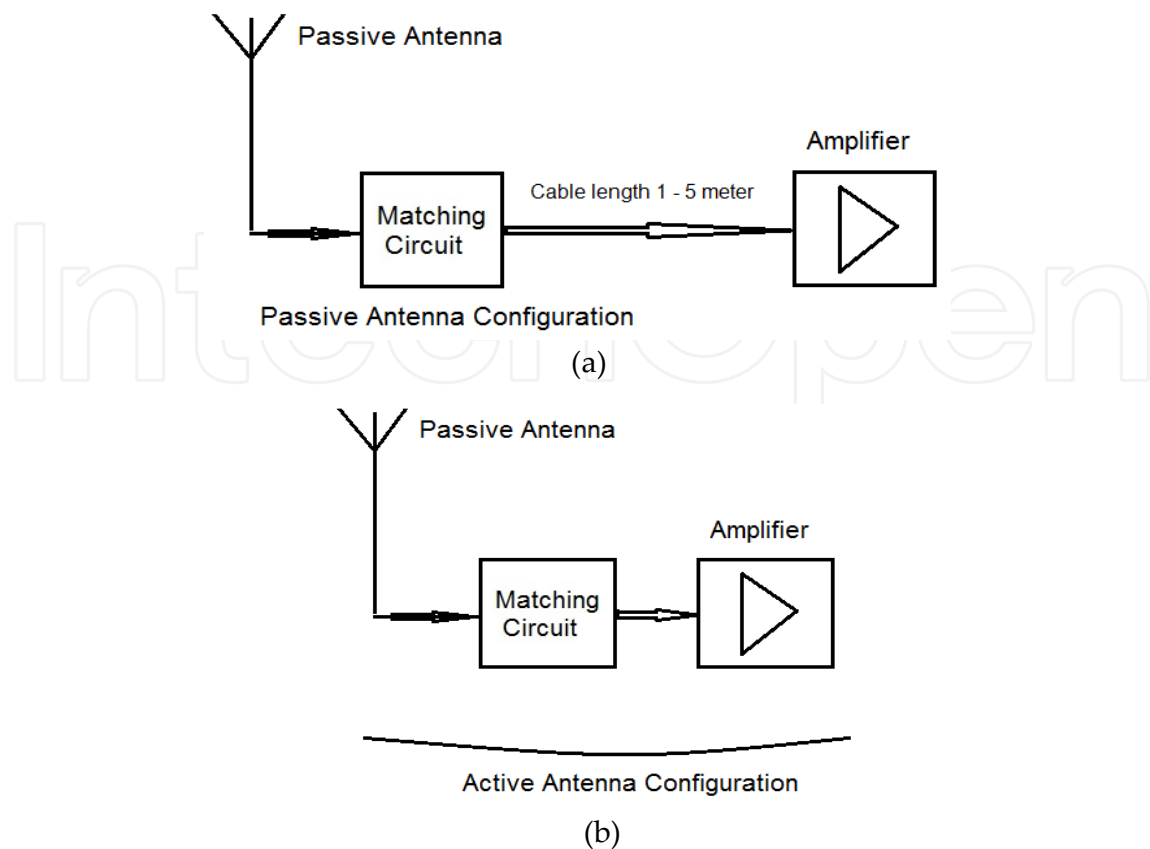

Figure 4. Passive and active antenna assembling comparison

5.2. Applications

The intelligent design of the antenna and integration with active circuit leads to innovative microwave and millimeter-wave application systems and considerable achievements in compactness, low cost, small profile, low power consumption, and multiple applications. This technology caused new designs in both areas of military and industrial applications such as wireless and radar communications, low cost sensors and transceivers [16].

The AIA concept has been extensively employed in the areas of power combining and quasi-optical power combining, beam steering and switching and retro directive arrays.

It also provides an effective solution to several fundamental problems at millimeter-wave frequencies including high transmission-line losses, limited source power, reduced antenna efficiency, and lack of high-performance phase shifters [15].

AIA is also used to design high-efficiency microwave power amplifiers recently. In other word, the antenna element is used as a part of circuit to terminate the harmonics at the amplifier output in addition to its traditional role of radiating electromagnetic waves.

Retro directive arrays are applicable in a wide range of applications such as self-steering antennas, radar transponders, search and rescue and wireless identification systems which are outcome of their omnidirectional coverage and the high level of gain. In these arrays any

incident signal will reflect back toward the transmitter without prior knowledge of its location [15].

Transponders are circuits which can be activated by an external explorer system transmitting signal in predefined frequency. In this case, transponder will transmit a response signal to the interrogator. These small low-cost microwave transponders are used for noncontact identifications such as entry systems, toll collection, and inventory control.

Transceivers and millimeter-wave vehicle radars are some other applications which are used respectively for wireless local area networks (WLANs) and for intelligent cruise control.

Additionally AIA can be an ideal choice for designing compact transceivers and transponders for wireless applications. In this case the whole RF subsystem, including active circuit and antenna can be built on a single substrate [15].

Active antennas are categorized depending on the function of active circuit integrated with them. The main functions of the devices in active antenna structures are generating and amplifying RF signals and frequency conversion. Based on previous discussion, the active antenna functions can be categorized into three types comprised of oscillator type, amplifier type and frequency type. This base unites can prepare possibility of more complicated functions by integrating with antenna such as transponders [16].

Some other benefits of using active antenna in microwave and millimeter wave frequencies are as below [17];

- Bandwidth increment and impedance matching improvement
- Improvement in sensitivity of receiver antennas and reduction of return loss and antenna dimensions
- Possibility of using active antenna arrays in microwave and millimeter wave signal generating
- Possibility of using active circuits in large antenna arrays which can eliminate the need to complicated RF circuits for phase shifters and advanced control electronics
- Development of using active antenna arrays in mobile communications
- Advancing beam steering techniques and their applications in smart antenna concept
- Possibility of using them to resolve channel capacity limitations by increasing data rates in future

As discussed in the previous part, for UWB applications, there are some limitations in using spiral antenna for broadband applications and it must be optimized to exhibit desirable characteristics. Using active antenna technology is one of effective optimization methods which leads to reduction of return losses and improvement in bandwidth, gain and input impedance [8].

To design a UWB active antenna with desirable parameters, study and design of an appropriate active circuit is an important step. Therefore distributed amplifier structure and parameters are reviewed in the next part as the active part of active antenna.

6. Distributed amplifier

Power amplifiers are essential parts of each transmitting system. They are used to amplifying signals to transmit from one point to another. Nonlinear effects of high power signals are the main differences between power amplifiers and the others.

In power amplifier design depending on application, higher efficiency, power and gain can be the main subjects of optimizations and linearity and noise figure are less considered.

Power amplifiers are categorized to different classes depending on active element bias and input/output signal forms.

Travelling wave structures are new methods to design of wideband amplifiers which have vast applications in wideband communications such as wideband travelling wave amplifiers, matrix amplifiers, travelling wave oscillators, mixers and power amplifiers . Concept and basic of travelling wave structures was initially originated by Percival in 1937. In 1940, this method was used to design of wideband vacuum tube amplifiers. But using GaAs MESFET in distributed amplifiers was studied at first by Moser in 1967 and Jutzi in 1969. They designed a distributed amplifier using lumped element technology and showed the ability of these circuits to achieve high gains in a wide frequency band [18].

6.1. Features

Because of the ultra-wide operating band of these amplifiers, they are receiving much attention. In a general amplifier, using parallel transistors lead to increasing the gain which is caused by summation of trans-conductances. But increasing input and output capacitors cause decrease in cutoff frequency. So as is shown in figure (5a), it does not solve the problem, because the multiplication of gain and bandwidth almost remains constant. In a distributed amplifier, low or high cutoff frequencies will be modified by summation of transistors trans-conductances and realization of additional LC transmission lines in the input/output sides. The result is illustrated in figure (5b) [18].

7. Antenna design and simulation

One of the most important and commonly used parameters in antenna design is the radiation pattern in the space around antenna. By defining antenna radiation pattern¹, radiation power in each direction and the direction which maximum power is emitted will be defined.

Since selected passive antenna is spiral antenna in this work, its radiation pattern is half-space. So if interior and exterior radiuses be selected according to the active zone and frequency range, E-plane and H-plane radiation patterns will be uniform in all frequency bandwidth and have few variations. Changing design parameters has no effect on antenna polarization and it has always circular polarization. All simulations of this chapter are done in ADS (Advanced Design System) software [19].

¹ Radiation Pattern

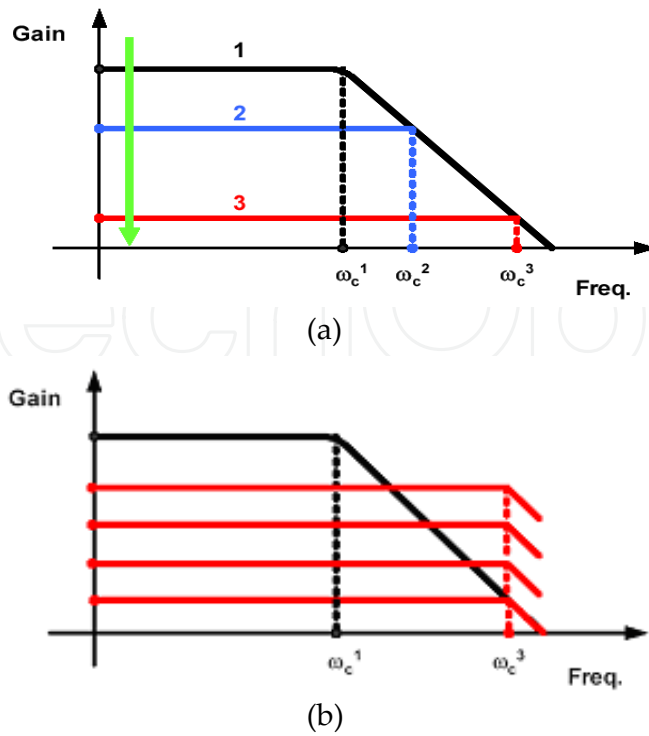

Figure 5. a).Trade-off between gain and bandwidth; b).high gain and wide bandwidth by distributed amplifier

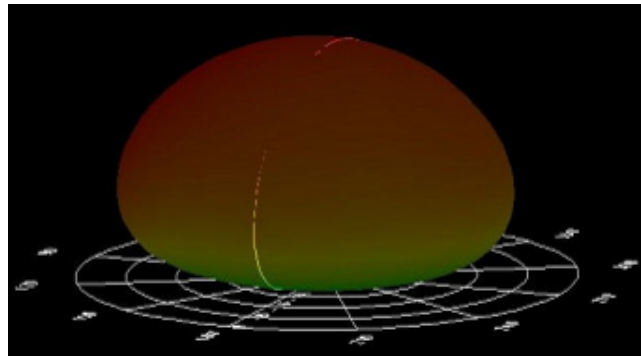

Figure 6. Spiral antenna radiation pattern in 3.36GHz

Other parameters which are effective in defining antenna performance are S_{11} ², Z_{11} ³, VSWR⁴ and Gain. Each of these parameters are simulated and illustrated for spiral antenna. Antenna dimensions are chosen similar to spiral antenna in reference [9], but substrate is different and a distributed power amplifier is used as the active part. To analysis of antenna dimensions and identify the active zone, relations (8) and (9) are used and radiation radius of high and low frequencies are calculated as below:

$$f_{low} = c / \pi r_2 \rightarrow 3 * 10^9 = 3 * 10^8 / \pi r_2 \rightarrow r_{out} = 31.8 \text{ mm} \tag{8}$$

² return loss

³ Input Impedance

⁴ Voltage Standing Wave Ratio

$$f_{\text{high}} = c / \pi r_1 \rightarrow 11 * 10^9 = 3 * 10^8 / \pi r_1 \rightarrow r_{\text{in}} = 8.7 \text{ mm} \quad (9)$$

r_{out} is exterior active zone radius for low frequencies and r_{in} is interior active zone radius for high frequencies. These dimensions show that the radius of $r=40$ mm is a good value. Simulation results are calculated and depicted in figure (7) and (8).



Figure 7. Antenna gain with $w = 4.54\text{m}$, $s = 4\text{mm}$ and $r = 40\text{mm}$

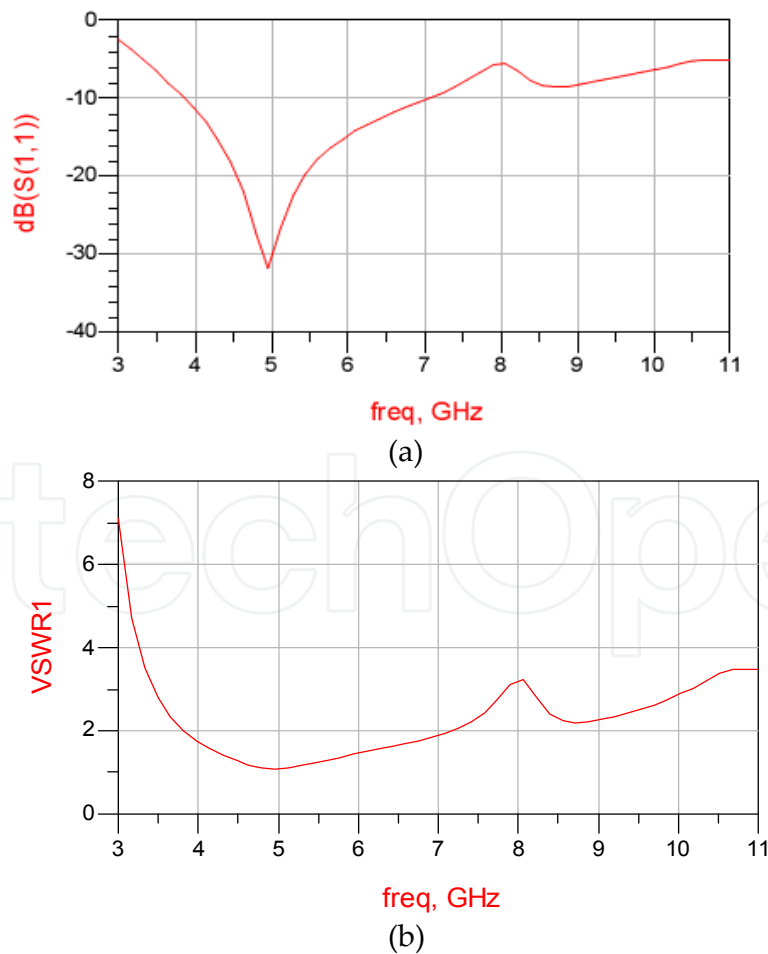

Figure 8. Spiral antenna parameters in the UWB Band; a) S_{11} and b) VSWR

Generally, in wireless communications, the antenna is required to provide a return loss less than -10dB over its frequency bandwidth [1]. As it is obvious, although spiral antenna parameters are good, to have desirable characteristics in the UWB band, optimization is necessary. In this work optimization is done by using a distributed amplifier and designing an active antenna [19].

7.1. Active circuit design

Active antennas are categorized depending on the active circuit behavior integrated with. Main functions of active antennas are generating and amplifying RF signals and frequency conversion. Here, designing a UWB distributed amplifier with uniform gain and return losses on the entire 3.1 to 10.6 GHz frequency band in the linear and nonlinear operation modes is the aim. Steps to design distributed amplifier are briefly described below;

Step 1. Selecting active element according to the project requirements

The first step is selecting a suitable active element which its linear and nonlinear models and parameters are accessible.

Step 2. Defining the optimum load resistance

After choosing suitable transistor, the optimum load resistance must be calculated to achieve maximum power in output

Step 3. Defining optimum number of amplifier stages

Optimum number of amplifier stages can be calculated using equation (10).

Step 4. Calculating 1dB point to define boundaries between linear and nonlinear regions of amplifier operation

For calculation of the optimum load resistance point, load power against load resistance curve is simulated as illustrated in figure (9). The load which gives maximum output power is the point [12]. Here Optimum Load Resistance is equal to 100 Ohms.

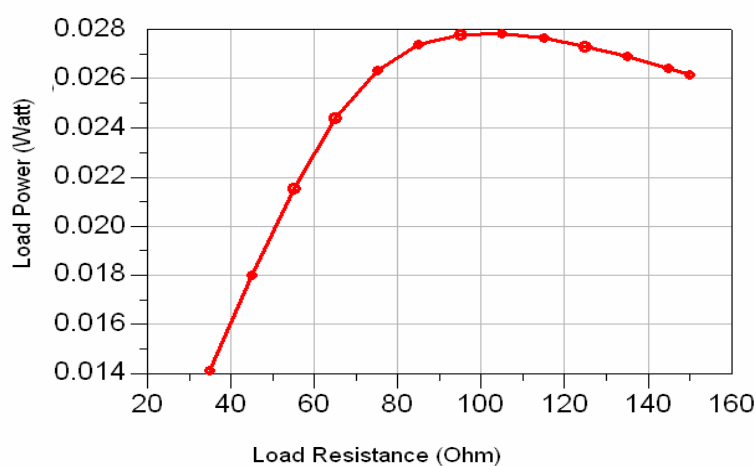

Figure 9. Load power against load resistance

After definition of optimum load and source resistance, now optimum amplifier stages can be calculated as bellow;

$$n_{opt} = \frac{Ln(\alpha_d) - Ln(\alpha_g)}{\alpha_d - \alpha_g} \quad (10)$$

Where α_d and α_g are drain and gate lines attenuation respectively. Calculation must be done in the highest frequency of bandwidth which is 11GHz because the optimum number of amplifier stages n_{opt} is calculated to have less reduction in gain and lower effects of attenuation constant on transistors in higher frequencies,.

Here n_{opt} was equal to 3. Then the 1dB point was calculated to define linear and nonlinear operation modes of the amplifier. As is shown in figure (10), m2 is 1dB point at 7GHz. In the other word, for input powers below -16 dBm, amplifier will work in the linear mode and for higher input powers it works in the nonlinear operation mode.

Various methods can be used for linear and nonlinear analysis of such a circuit. Some of them are discussed in reference [19]. To more studies, see references [20 to 26].

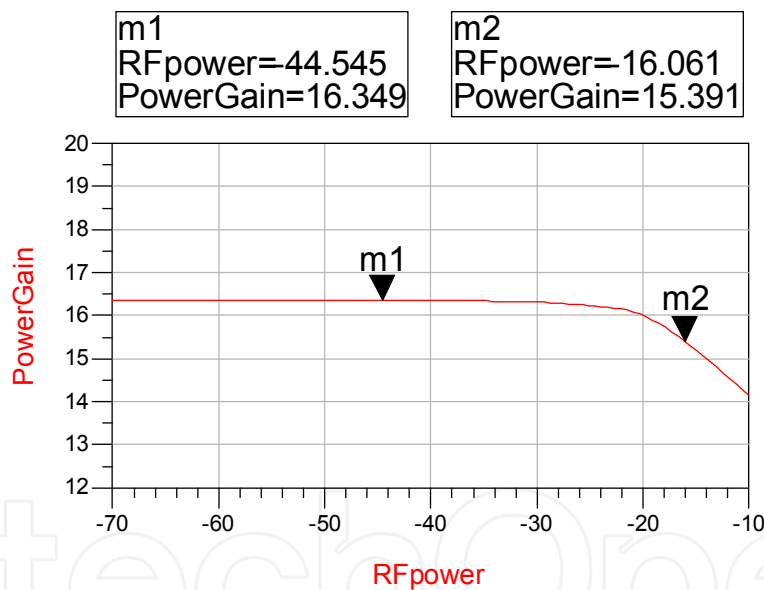

Figure 10. 1dB point calculation in 7GHz. RFpower is input power

7.2. Simulation

Distributed amplifier shown in figure (5) is simulated in the linear region of its operation with 50Ω load and matching network. Distributed amplifier structure is shown in figure (11) [11].

UWB distributed amplifier parameters are shown in figure (12). These results show a rather uniform gain and good return losses over this band. The results of this work and other experiences show that optimizing the integrated circuit of antenna and active circuit is more useful than optimizing each of them separately and then matching them by a matching network [11].

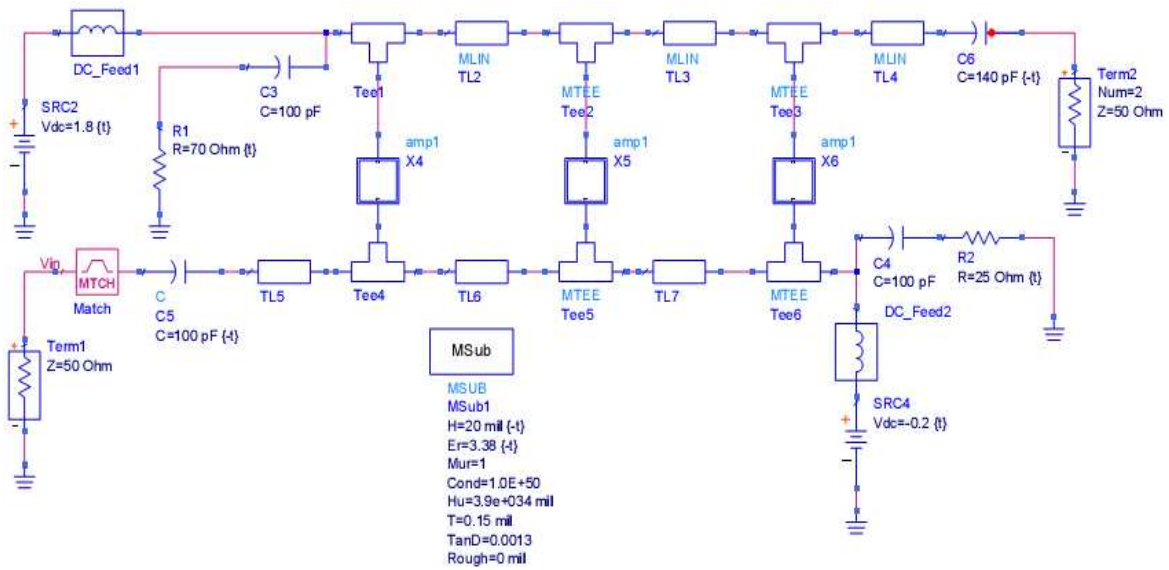
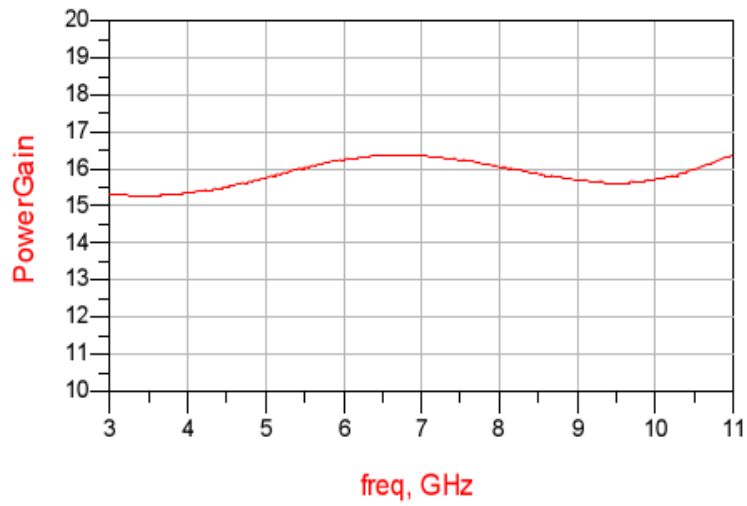
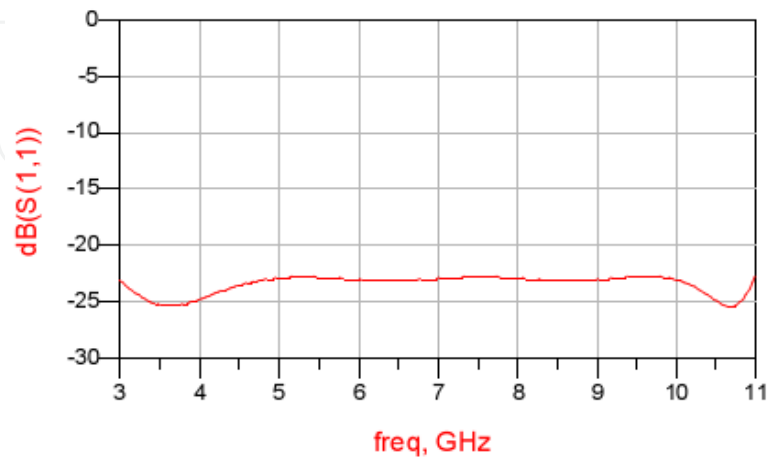

Figure 11. Designed distributed amplifier structure.



(a)



(b)

Figure 12. UWB distributed amplifier parameters; a) Gain. b) S_{11}

7.3. Active antenna simulation results

After design and simulation of passive spiral antenna and UWB distributed amplifier separately, spiral antenna is added to the active circuit as a load and specifications of this combined circuit is analyzed. For more accurate results, simulation is done by electromagnetic simulator “momentum” of ADS software. Simulated parameters of active antenna in linear mode are shown in figure (13).

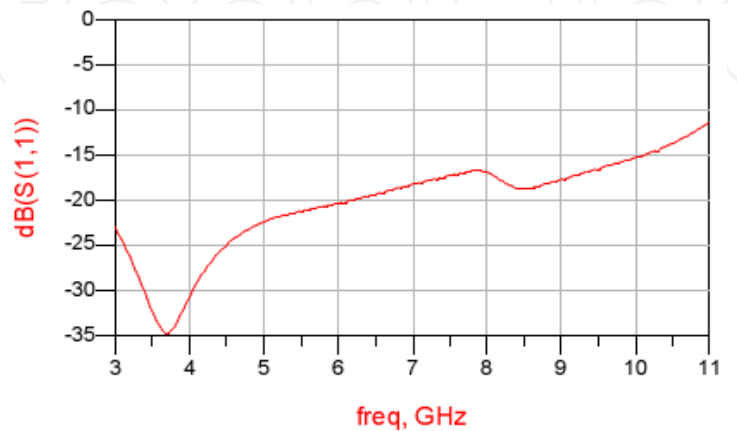

(a)

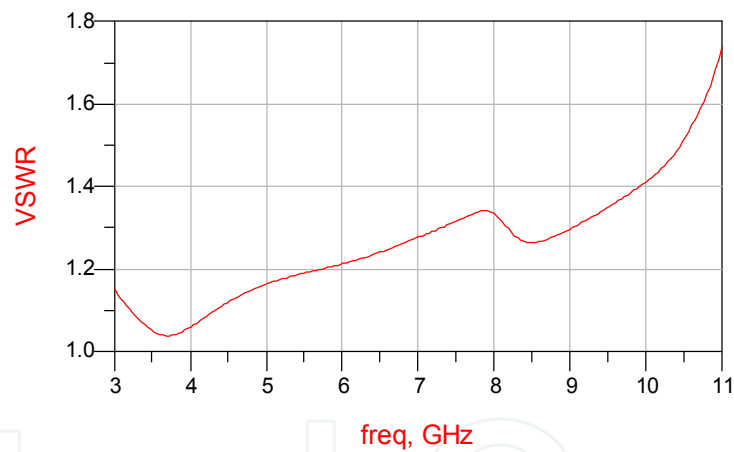

(b)

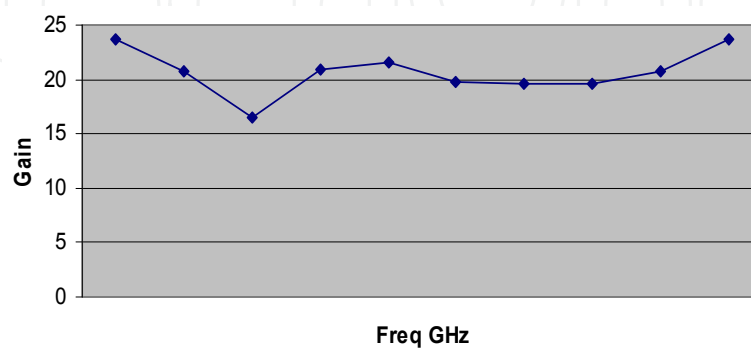

Freq GHz

(c)

Figure 13. Linear active antenna parameters; a) S11, b) VSWR and c) Gain

In the figure (14), active and passive antenna simulation results are shown. Comparing these results shows that active antenna parameters are considerably optimized rather than passive one. These results were predictable when the features of active antenna were introducing and now it is approved. It is important to know that the final circuit gain is not equal to the summation of passive antenna and active circuit gains. Total gain is calculated by replacing passive antenna as a load to the active circuit and calculating circuit gain [19].

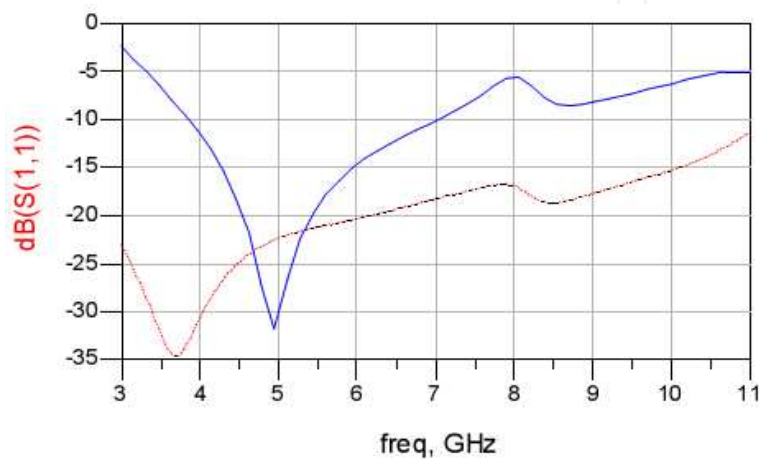

(a)

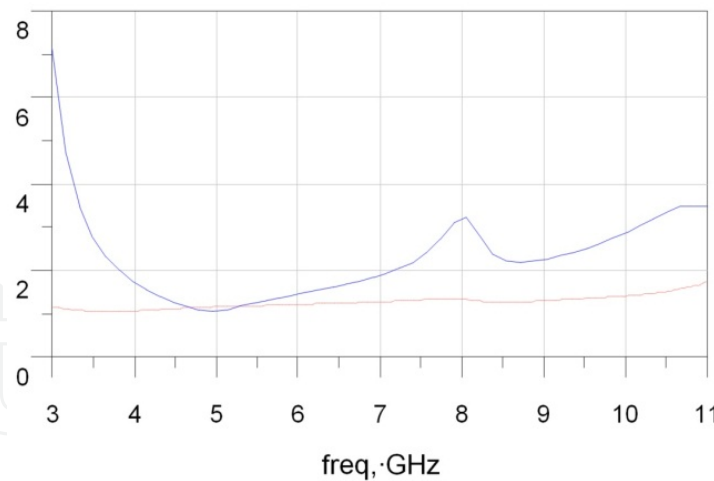

(b)

Figure 14. a) S_{11} and b) VSWR. The blue curve is passive antenna parameter and the red one is active antenna parameter. Active and passive antenna parameters comparison shows that linear active antenna parameters are optimized in compare with passive one.

In a similar work, M. Jalali et al. [27] optimized a spiral antenna using active integrated antenna technology for linear operation mode. Results are shown in figure (15).

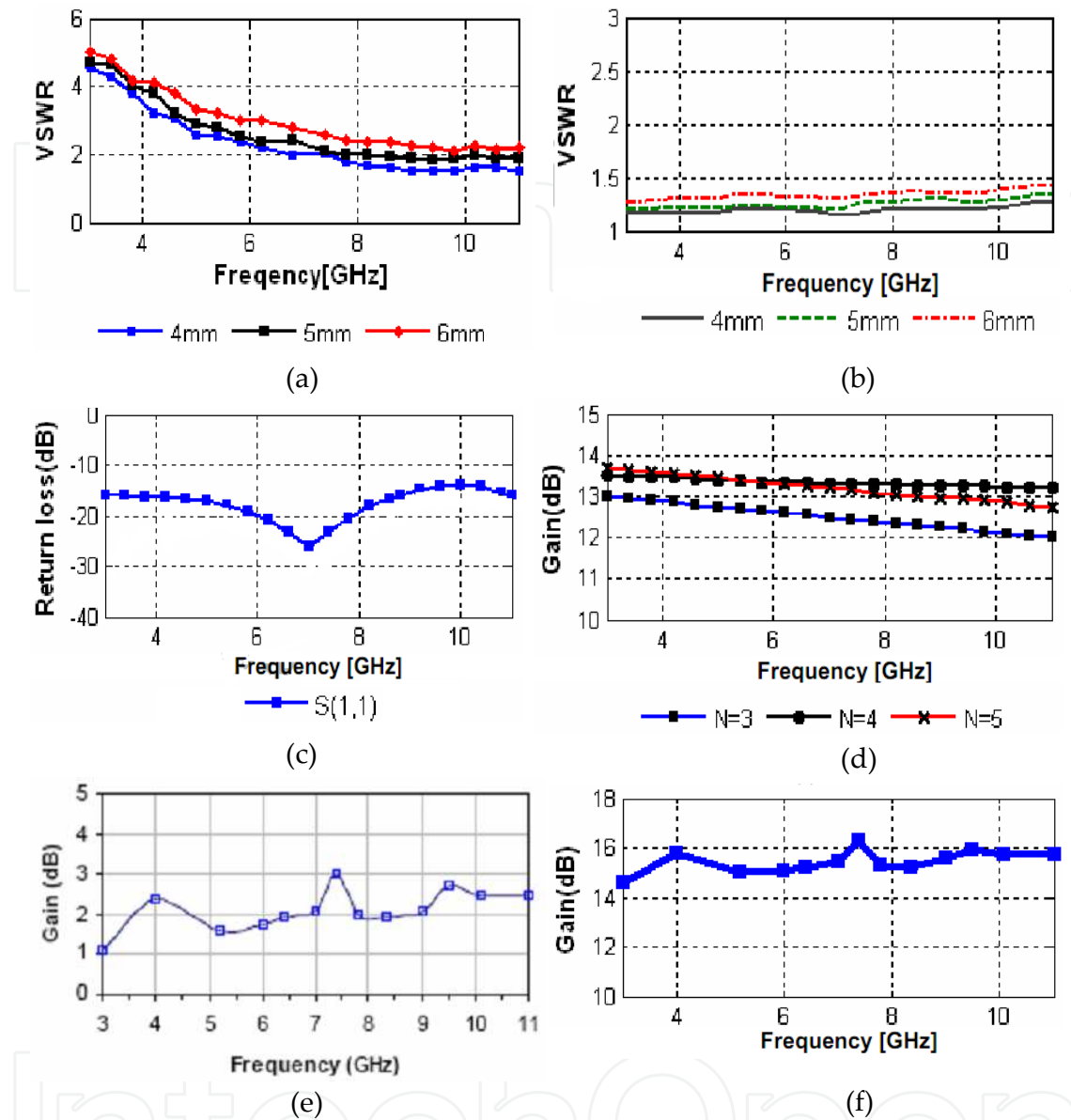
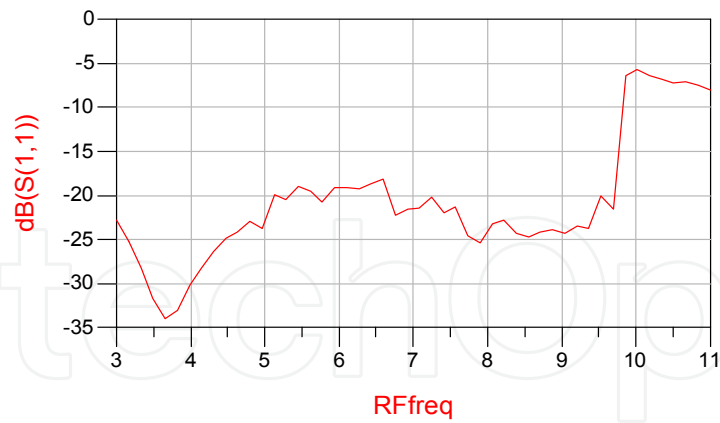
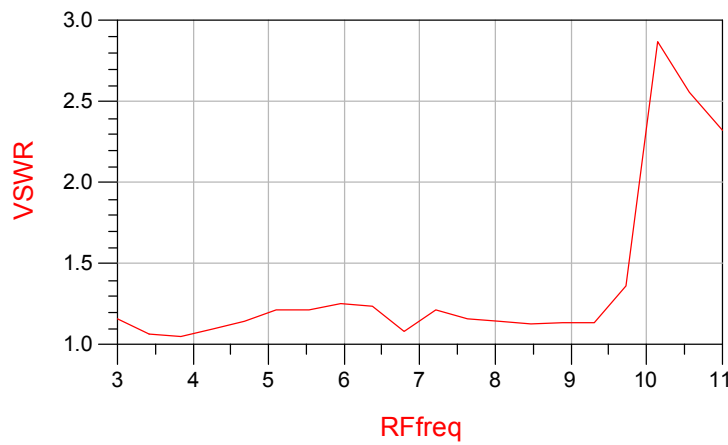

Figure 15. Passive antenna parameters and optimized parameters of active antenna [27]; a) VSWR of passive spiral antenna in $w=4, 5$ and 6 mm; b) VSWR of optimized active antenna in $w=4, 5$ and 6 mm; c) Return loss of optimized active antenna; d) Uwb distributed amplifier gain for $N=3,4$ and 5 (N is the turns of spiral antenna); e) Gain of passive spiral antenna; f) Gain of optimized active antenna

By using active circuit specifications calculated in part 7, nonlinear simulation of active antenna is done here. In this case, input power is more than the power calculated for 1dB point and antenna works in nonlinear mode. For nonlinear analysis of antenna, large signal model and parameters of circuit elements must be used. For special applications and higher output power requirements, power amplifiers and nonlinear operation may be considered. Results are shown in figure (16). For more information see [19].



(a)



(b)

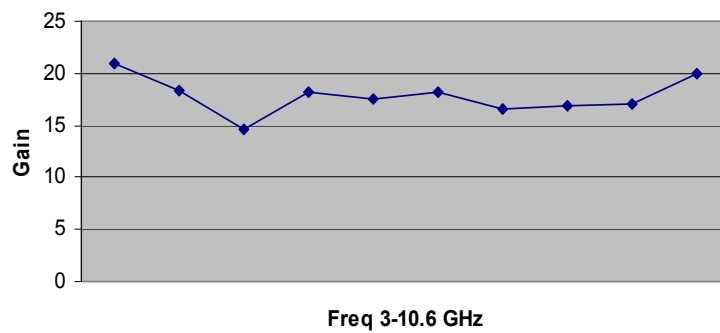

(c)

Figure 16. Nonlinear active antenna parameters; a) S11. b) VSWR. c) Gain

8. Conclusion

In the designed UWB active antenna, parameters are almost uniform in the entire band. It is again emphasized that one of very important requirements of UWB systems is having uniform parameters on the all 3.1 to 10.6 GHz frequency band, because all signal frequency elements must amplify uniformly to not distort transmitted signals. Comparing with results in reference [8], gain is increased about 5dB and final amplifier stages are reduced

from 4 to 3 and return losses are significantly low. Comparing figures (7 and 13), shows usefulness of adding active circuit to passive antenna to increase gain and make antenna parameters uniform and desirable. This antenna can also amplify narrow band signals which are in this frequency band in addition to amplifying UWB signals with frequency elements in whole band.

Author details

Danial Nezhad Malayeri
South of Kerman Power Distribution Company, Kerman, Iran

Acknowledgement

I thank to Dr Ahmad Hakimi from Shahid Bahonar University of Kerman for his guidance and assistance and Dr Abdipour from Tehran Amirkabir University of Technology. This work was supported by South of Kerman Power Distribution Company and Telecommunication Research Center of Iran.

9. References

- [1] J. Liang. Antenna Study and Design for Ultra Wide Band Communication Applications. Department of electronic engineering Queen Mary, University of London, United Kingdom, July 2006
- [2] FCC, First Report and Order 02-48, February 2002.
- [3] J. Igor Immoreev, "Ultra-wideband Systems. Features and Ways of Development", Ultra Wideband and Ultra Short Impulse Signals, 19-22, Sevastopol, Ukraine, September, 2004.
- [4] J. M Wilson, "Ultra-Wideband /a Disruptive RF Technology", Intel research & development, Version 1.3, September 10, 2002.
- [5] M. Tanahashi, "Design Technologies of RF devices for UWB Simulation", Ansof High Performance Applications Workshop, TRDA Inc. / Taiyo Yuden, October 27, 2005.
- [6] V.H. Rumsey, "Frequency Independent Antenna," IRE National Convention Record, pt.1, pp. 114-118. 1957.
- [7] W.R. Deal, V. Radisic, Y. Qian and T. Itoh. "RF Technology for Low Power Wireless Communications ", Wiley & Sons Inc. 2001
- [8] M. Pourjalali, "Analysis, design and simulation of active antenna in UWB band ", Tehran Amirkabir University of Technology, MSc. Thesis. 2006
- [9] J. Lin, and T. Itoh, "Active Integrated Antennas", IEEE Transactions on Microwave Theory and Techniques, Vol 12. 12th December 1994.
- [10] J. R. Copeland, W. J. Robertson, and R G. Verstraete, "Antennafier arrays," IEEE Trans. Antennas Propagate, Vol. AP- 12, pp. 227-233, Mar. 1964.
- [11] E. Marzolf, M.H. Drissi, Global Design of an Active Integrated Antenna for Millimeter Wave.

- [12] D. E.J. Humphrey, V.F. Fusco and S. Drew, "Active Antenna Array Behavior", IEEE Transactions on Microwave Theory and Techniques, Vol. 43, No. 8, August 1995.
- [13] F. Carrez, R. Stolle, J. Vindevoghel, "Integrated Active Microstrip Antenna for Communication and Identification Applications", IEEE. 1997.
- [14] A. Ramadan, Active Antennas with High Input Impedance Low Noise and Highly Linear Amplifiers. Universitat der Bundeswehr München, July 2005
- [15] Y. Qian, and T. Itoh, "Progress in Active Integrated Antennas and Their Applications", IEEE Transactions on Microwave Theory and Techniques, Vol. 46, No. 11, November 1998
- [16] R. Garg, P. Bhartia, I. Bahl, A. Ittipiboon, Microstrip Antenna Design Handbook, Artech House, Inc. 2001.
- [17] S.L. Loyka, J.R. Mosig, "Nonlinear Modeling and Simulation of Active Array Antennas", 5th COST 260 MC & WG Meeting, Wroclaw, Poland, 30 June 1999.
- [18] S. Asadi, "Design and Simulation of UWB Distributed Power Amplifier ". Amirkabir university of Tehran (Politechniques), MSc. Thesis, 2006
- [19] D. Nezhad Malayeri: "Design, Simulation and Nonlinear Analysis of UWB Active Antenna" Shahid Bahonar university of Kerman. MSc. Thesis, 2009
- [20] V. Rizzoli, A. Costanzo and P. Spadoni, "Computer-Aided Design of Ultra Wide band Active Antennas by Means of a New Figure of Merit", IEEE Microwave and Wireless Components Letters, Vol. 18, No. 4, April 2008.
- [21] C.C. Penalosa, "Numerical Stady-State Analysis of Nonlinear Microwave Circuits with Periodic Excitation", IEEE Transactions on Microwave Theory and Techniques, vol. MTT-31, p. 724-730, Sept. 1983.
- [22] N. Soveiko, and M. Nakhla, "Wavelet Harmonic Balance", IEEE Microwave and Wireless Components Letters, December 12, 2002.
- [23] Y. Zhang, P. Gardner, H. Ghafouri-Shiraz and P.S. Hall, "FDTD Analysis of Microwave Active Integrated Antenna Including Nonlinear Model of FET Transistor", 3rd International Conference on Microwave and Millimeter wave Technology Proceedings, 2002.
- [24] J. Zhang, Y. Wang, and Y. Chen, "Analysis of Active Antenna by using Piecewise Harmonic Balance Technique and Neural Network", International Journal of Infrared and Millimeter Waves, Vol. 18., No. 5, 1997.
- [25] R. Goyal and V. Veremey, "Application of Neural Networks to efficient Design of Wireless and RF Circuits and Systems", Xpedion Design Systems, Inc.
- [26] V. Rizzoli, A. Neri, D. Masotti and A. Lipparini, "A New Family of Neural Network-Based Bidirectional and Dispersive Behavioral Models for Nonlinear RF/Microwave Subsystems", (InvitedPaper), Wiley & Sons, Inc., John 2002.
- [27] M. Jalali, A. Abdipour, A. Tavakoli, and G. Moradi, "Performance Amelioration of an Active Integrated Spiral Antenna System for UWB Applications", Iranian Journal of Electrical and Computer Engineering, Vol. 7, No. 1, Winter-Spring 2008