

We are IntechOpen, the world's leading publisher of Open Access books Built by scientists, for scientists

4,800

Open access books available

122,000

International authors and editors

135M

Downloads

Our authors are among the

154

Countries delivered to

TOP 1%

most cited scientists

12.2%

Contributors from top 500 universities



WEB OF SCIENCE™

Selection of our books indexed in the Book Citation Index
in Web of Science™ Core Collection (BKCI)

Interested in publishing with us?
Contact book.department@intechopen.com

Numbers displayed above are based on latest data collected.
For more information visit www.intechopen.com



Electric Power System Operation Decision Support by Expert System Built with Paraconsistent Annotated Logic

João Inácio Da Silva Filho, Alexandre Shozo Onuki,
Luís Fernando Pompeo Ferrara,
Maurício Conceição Mário, José de Melo Camargo,
Dorotéia Vilanova Garcia,
Marcos Rosa dos Santos and Alexandre Rocco

Additional information is available at the end of the chapter

<http://dx.doi.org/10.5772/51379>

1. Introduction

In the last decades there has been a gradual increase of the industrial park in several countries which demands energy, especially electric power. This situation caused a considerable expansion of the sector responsible for generation and distribution of electric power in a very short period of time. The rapid expansion caused a significant increase of generation sources and of distribution branches of electric power which originated enormous and complex agglomerates with interconnections among themselves and with a certain degree of dependence and vulnerability.

This complexity of electric power systems brought up technical needs and technological challenges in order to obtain efficient methods to monitor the variables of the electric quantities which express the operational normality state of the networks. Together with the need of energy production the priority, the sentiment of priority given to the extraction forms and the correct usage of energy by mankind came up. This sentiment brought up new public policies of generation and distribution of electric power. Currently, the laws concerning this issue have concentrated on the supervision of the concessionary companies which are responsible for the provision of electric power, making sure that these companies offer energy with a high-quality level to the consumers. Besides these obligations, the utilities companies

also have the need of markets and because of that they have big interest in the modernization of the management, monitoring and control of their power systems. Due to these facts, a huge effort and investment of the concessionary companies in the research are which deals with the quality of electric energy offered to consumers has been verified [1].

One of the indexes which measure the quality of electric power offered to consumers is obtained by the number of outages or failures in the energy distribution of the electric power system (and time length) in a certain period of time. When an electric power system is overloaded, it is possible that its equipments may be disconnected by relays which act as protection, causing the interruption of electric power in certain areas covered by its transmission networks.

That being so, it is very important to research new methods that effectively evaluate the state of outage risk due to overloads in the system because it is extremely important, in order to decrease indexes of energy interruption to consumers, to manage the power loads with permanent monitoring of the distribution lines of electric power. However, in the case of an interruption, it is also fundamental to make decisions quickly and safely in order to reconnect systems after an outage.

1.1. Electric Power System Overview

A typical electric power system can be divided in generation and systems of transmission, sub-transmission and distribution. The transmission system interconnects generating stations to large substations located near load centers generally using aerial electric transmission lines. The sub-transmission system distributes energy to an entire district and usually uses aerial electric transmission lines. The distribution system transports energy from the local substation to individual houses, using aerial or underground transmission lines [7]. A typical electric power system can be seen in Figure 1.

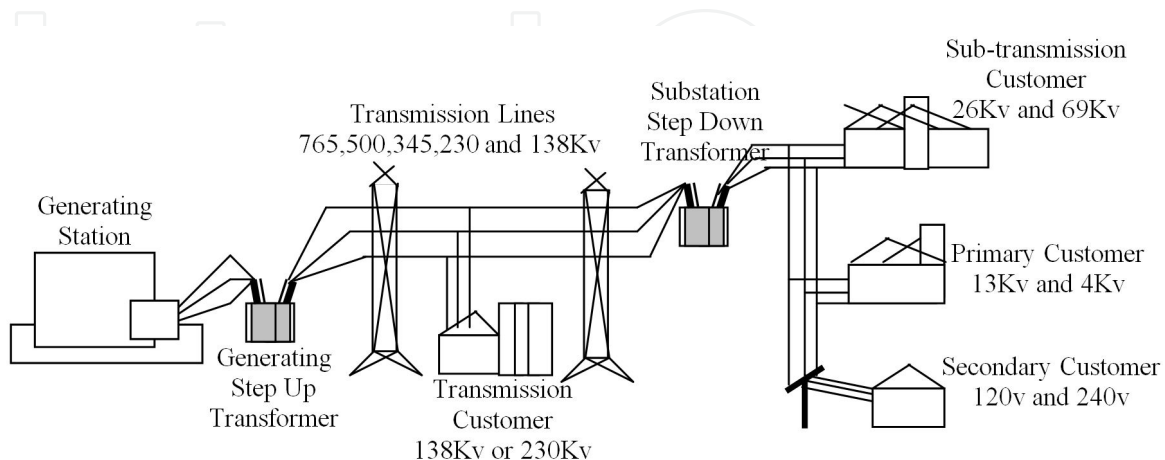

Figure 1. Simplified picture of a typical electric power system.

A typical transmission system has three phase conductors to take the electric current and transport power. Each phase of the transmission line is built with two, three or four parallel conductors separated approximately by 1.5 ft (0.5 m) [3][7].

1.2. Main Problems of an Electric Power System

It is well known that operation failures in an electric power system are unavoidable and there are a large number of reasons why these interruptions happen. This situation is due to the natural conditions of an electric power system in which failures may happen because of internal or external causes, such as consequences of environmental physical phenomena which are beyond the physical specifications of the electric systems or even human error [3].

There also is a fundamental limitation on the electricity distribution: with few exceptions, electric power cannot be stored which means that it must be generated as it is demanded. That being so, an electric power system must provide electric power with safety and with acceptable tolerance ranges either for a normal load or for a demand condition of maximum load or of peak [1][2]. Since the demand periods of peak load, due to the several types of industry or to different types of housing, are different from region to region, this natural condition of electricity brings up a problem of generation control and transmission.

In certain regions industries can be more productive in certain times of the day and show a drop in demand because of lunch time, so the demanded energy has variations during the day. In highly densely populated regions where there is a lot of night life businesses, the energy demand is larger in the evening and also depends on the day of the week and even on the season of the year.

Besides this problem particular to each industrial park or city, another factor to consider is the climate of the region where these industries or residences are located. In regions with very hot weather, turning on air conditioning system in the hottest period of the year, the energy demand values are higher in the late afternoon. For regions with very cold weather the energy demand has different effects on the global load of the electric power system because in the coldest period of the year heaters are turned on in the morning and in the evening.

These situations of difficult control makes power or demand for electric energy vary and besides, the capacity of a transmission line to transport electric power is limited by physical and electrical parameters of its conductors. In order to avoid interruptions these conductors of electric energy in any load conditions must be sufficient to respond to the demand within limits such that their safety relays will not be activated.

Transmission lines are subject to environmental adversities including large temperature variations, high winds, storms, etc. Thunders that fall on transmission towers cause high voltages and propagating waves in the transmission lines which usually cause the destruction of isolators and as a consequence of that the protection relays interrupt the power transmission through the networks [7].

1.3. The voltage variation and Overcurrent as Overload Risk Factors

According to what was seen, in an electric power system the loads represented by the electric power consumers, such as electric machines of industries, lighting systems, heating devices of residences and refrigeration systems of businesses, are not static. They are constantly changing, being turned on and off with value variations which may lead to overload. The overloads are outage risks for the whole system because it increases the intensity of the electric current (overcurrent) in the lines and can heat the conductors, increasing their temperature and causing permanent damage with the interruption of energy transmission.

The existence of load variations requires precise equipments which adjust the voltage in the line, because the overload causes the voltage outage. The voltage variation can aggravate the electric power system state with emergence of large intensities in distribution branches. Because of that, the decrease value or the voltage outage (under-voltage) and the intensity value of the electric current (overcurrent) are two important risk factors to the monitoring of transmission lines of electric power. That being so, the monitoring of the ranges of voltage outage and of maximum current of an electric power system are used as a diagnosis of overloads. In order to increase the quality index these two factors must be constantly monitored because if they both are out of the ranges specified in their projects the possibility of disconnection of the electric power system will be higher.

2. Artificial Intelligence and Electric Power Systems

Artificial intelligence techniques have become necessary to procedures of monitoring, management and control of electric power systems. The current expansion of electric power systems is physically verified by the increase of branches and by the way distribution lines are installed: generators and loads are interconnected with the distribution lines through multiple paths (radial form) and in ring among them. This technique increases the confidence index on the system because the failure of one line does not cause a total failure of the system and can provide the transmission of electric power from other of its branches. Every new technique offers certain advantages, however when a new technique is implemented, there is an increase of the complexity of the electric power system. Because of that there is the need of an efficient protection in which the sector responsible for the energy transmission and distribution as well as the generating sector are controlled in a quick and efficient way in order to keep the power generated according to the charges required. That said so, energy generation must be kept according to the conditions established by the load and comply with the conditions in which the protection systems are capable of prevent failures of the generation equipment due to possible overloads [3][7].

Recently, new techniques from artificial intelligence (AI) made possible to connect multiple generating sources of electric power as well as loads to the transmission system. However, although all these new factors make access easier, they may cause problems by destabilizing

the system, which requires a sophisticated AI based control to assure capable and efficient control of the generation according to the demand. These actions which modify the operational state of the electric power systems at any time must be controlled in order to provide power transference in a safe and coordinated way.

Nowadays, the software SCADA is installed in the electric power systems. SCADA stands for Supervisory Control and Data Acquisition and provides in real-time large amounts of information about values related to electric quantities of the electric power system which can be obtained from points of the transmission network. Such quantities are, for example, voltage, current and potency. The information obtained by the SCADA system are used as input for the analysis systems and decision-making [1][8][9]. However, due to the large amount of information received by the control centers, interference and natural failures in the synchronization of the transmission, it is not always that the information brought for analysis by SCADA are complete. Because of that, a databank is created and contains ambiguous, vague and contradicting data. Due to the nature of these data a human operator could be led to make false interpretations or even make wrong decisions which could lead to huge losses and delay of the system restoring [1] with damage to the quality index desired. That being so, it became very urgent to have computational treatment with expert systems dedicated to interpretation, data analysis and the presentation of suggestions as a way of supporting the operation of electric power systems.

2.1. Expert Systems structured in non-classical logics

Artificial Intelligence research oriented to electric power systems has as its goal to find ways of designing new computational tools for the support of decision-making of the team responsible for the correct operational action. However, due to the large number of electric keys (breakers that modify the system's topology), to variations on the values of loads and to other several factors inherent to an electric power system, there are many difficulties to find efficient ways. The methods which use conventional binary classical logics to analyze data from the electric power system with the capability of offering suggestions for the optimized restoring after a failure has not provide good results. One of the difficulties found in the design of models based in classic logics is its condition of being defined by rigid binary laws which lead to equations which are extremely complex to reproduce models. Besides, these equations almost always lead to a combinatorial explosion. Due to this aspect, in this area of artificial intelligence, projects designed with the goal of analysis and decision-making based in classic logics has found many difficulties. It is verified that the low efficiency showed by these projects which use classic logics comes up when a large amount of data has to be computed. These data almost always have redundancies which bring up incompleteness and contradiction invalidating important information for the analysis. Some classic works use complex algorithms with good results but the computation time is very high making the response time long which is unfeasible in real conditions where an electric power system always demands quick and direct actions in order to avoid bigger damages.

2.2. Expert Systems Based on Paraconsistent logics

These problems found in classical projects lead to the conclusion that the algorithms based on the concepts of non-classic logics may show a better efficiency in the design of expert systems dedicated to the analysis and treatment of uncertain data originated in complex data-banks such as the one of an electric power system.

Based on these considerations we introduce in this paper a paraconsistent expert system (PES) with algorithms based on the theoretical concepts of the Paraconsistent logics (PL) which is a non-classic logics whose main basic theoretical features is, under certain conditions, to accept contradicting values so that the conflict does not invalidate the conclusions [5][9][10].

The paraconsistent expert system (PES) introduced in this work has the role of performing the analysis of the information coming from the electric power system in the sector of energy sub-transmission treating possible contradictions in the information signals. Through the analysis of values of voltage and electric current and the consideration of the states of connection or disconnection of the electric keys in the substations, PES informs about the risk conditions of overload and about the different configuration topologies of the electric power system.

When a failure, that triggers the interruption of the transmission of energy, happens, PES informs the operators of the sub-transmission system how to proceed with the actions for the restoring in an optimized way. Given the real-time monitoring, the analysis that PES performs is based on data before the occurrence of the failure, which allows PES to indicate the best and most efficient sequence of connecting electric keys in the interrupted section. The actions indicated by PES take into consideration the restrictions of load, technical and safety norms due to the conditions imposed to that particular situation.

3. Paraconsistent Logics – Equations and Algorithms

Aristotelian or classic logics are called so due to its origin being attributed to Aristotle and his disciples, and its foundations are supported by strict binary principles which can be concisely described by: principle of identity, principle of bivalency, principle of non-contradiction and principle of the excluded middle. Basically, all current technology is built based on the principles of the classic logics. However, due to its binary foundations, it cannot be applied or cannot offer satisfactory responses in some real situations such those where incompleteness and contradiction are expressed.

In order to overcome these difficulties and fulfill the need of satisfactorily model certain conditions of the real world, several logics, which reject some of the classic principles or which accept certain conditions not included in the classic logics, have appeared recently. The special logics are called non-classic and among them there is the paraconsistent logic (PL) which has the main property of being capable of accepting contradiction in its foundations.

3.1. Paraconsistent Annotated logics - PAL

Among the several families of paraconsistent logics there is the logics called paraconsistent annotated logics (PAL) [5] which belongs to the class of evidential logics and allows analysis of signals represented by annotations [5][9][11]. In its representation each annotation μ belongs to a finite lattice τ which assigns values to its corresponding propositional formula P .

For the PAL each evidence degree μ from its representing lattice, whose value varies from 0 and 1 in a closed interval of real numbers, assigned to the proposition P a logical state represented on the vertexes. By means of a special logical operator, the interpretations on the lattice of the PAL allow the creation of equations which provide algorithms for the paraconsistent analysis with evidence degrees extracted from real physical systems.

3.2. Paraconsistent Annotated logics with Annotation of two values - PAL2v

The paraconsistent annotated logics with annotation of two values (PAL2v) is an extension of the PAL and to each propositional formula P is assigned an annotation given by two evidence degrees as follows:

An evidence degree (μ) which is favorable to proposition P and an evidence degree (λ) which is unfavorable to proposition P .

The annotation composed by two evidence degrees (μ, λ) gives proposition P a connotation of paraconsistent logical state ε_τ which can be identified on the extreme vertexes of the lattice: inconsistent (\top), true (t), false (F) or indeterminate (\perp) [9]. That being so, in the representation of the PAL2v, a paraconsistent logical signal is represented by proposition P and its annotation, which is composed by two evidence degrees, such that: $P_{(\mu, \lambda)}$ with $\mu, \lambda \in [0, 1] \in \mathfrak{R}$.

3.3. The Equations of PAL2v

The PAL2v can be studied with the unitary square of the Cartesian plane (USCP) as shown in Figure 2 where, through linear transformations, values on the two representing axes of a lattice similar to the one associated with the PAL2v.

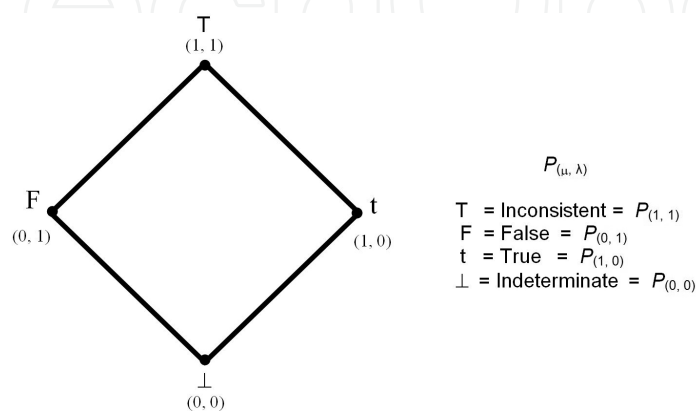

Figure 2. Lattice of four Vertexes.

Doing so, we can write paraconsistent equations on the lattice in which terminologies and conventions are established [5] around paraconsistent logical states attributed to proposition P . After the expansion actions with intensity $\sqrt{2}$, rotation of 45° with respect to the origin and translation along the vertical axis, the linear transformation is defined by:

$$T(X,Y)=(x-y, \quad x+y-1) \quad (1)$$

According to the language of the PAL2v we have:

$x = \mu$ is the Favorable evidence Degree

$y = \lambda$ is the Unfavorable evidence Degree.

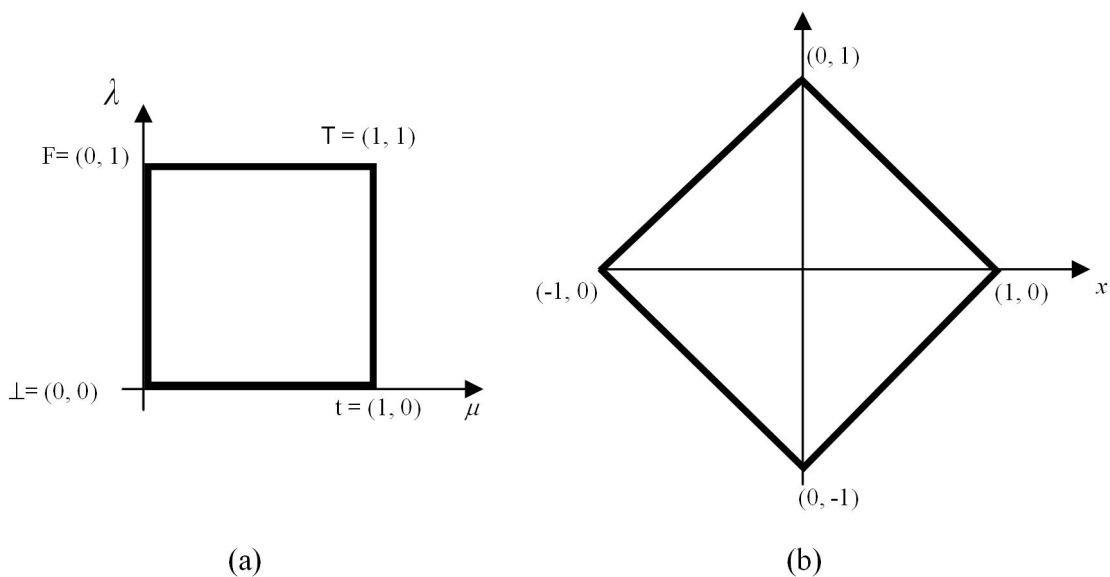

Figure 3. a) Unitary Square in the Cartesian Plane (USCP). (b) Lattice κ with another system of coordinates with values.

The first coordinate of the transformation (1) is called *Certainty Degree* D_C .

$$D_C = \mu - \lambda \quad (2)$$

The first coordinate is a real number in the closed interval $[-1,+1]$. The x-axis is called “*axis of the certainty degrees*”.

The second coordinate of the transformation (1) is called *Contradiction Degree* D_{ct} .

$$D_{ct} = \mu + \lambda - 1 \quad (3)$$

The second coordinate is a real number in the closed interval $[-1,+1]$. The y-axis is called “*axis of the contradiction degrees*”.

3.4. The Paraconsistent States Logic ε_τ

Since the linear transformation $T(X,Y)$ shown in (1) is expressed with evidence Degrees μ and λ , from (2), (3) and (1) we can represent a Paraconsistent logical state ε_τ into Lattice τ of the PAL2v [3], such that:

$$\varepsilon_{\tau(\mu,\lambda)} = (\mu - \lambda, \mu + \lambda - 1) \quad (4)$$

or

$$\varepsilon_{\tau(\mu,\lambda)} = (D_C, D_{ct}) \quad (5)$$

where: ε_τ is the Paraconsistent logical state.

D_C is the Certainty Degree obtained from the evidence Degrees μ and λ .

D_{ct} is the Contradiction Degree obtained from the evidence Degrees μ and λ .

Since the Paraconsistent logical state ε_τ can be anywhere in the lattice τ , the real Certainty Degree D_{CR} can be obtained as follows:

For $D_C > 0$ we compute:

$$D_{CR} = 1 - \sqrt{(1 - |D_C|)^2 + D_{ct}^2} \quad (6)$$

For $D_C < 0$ we compute:

$$D_{CR} = \sqrt{(1 - |D_C|)^2 + D_{ct}^2} - 1 \quad (7)$$

where: $D_C = f(\mu, \lambda)$ and $D_{ct} = f(\mu, \lambda)$

For $D_C = 0$ we consider the undefined Paraconsistent logical state with: $D_{CR} = 0$.

We compute the resulting evidence Degree which expresses the intensity of the Paraconsistent logical state ε_τ by:

$$\mu_{ER(\mu,\lambda)} = \frac{D_{CR} + 1}{2} \quad (8)$$

where:

$\mu_{ER(\mu,\lambda)}$ is the resulting evidence Degree in function of μ and λ .

D_{CR} is the real Certainty Degree (6) or (7).

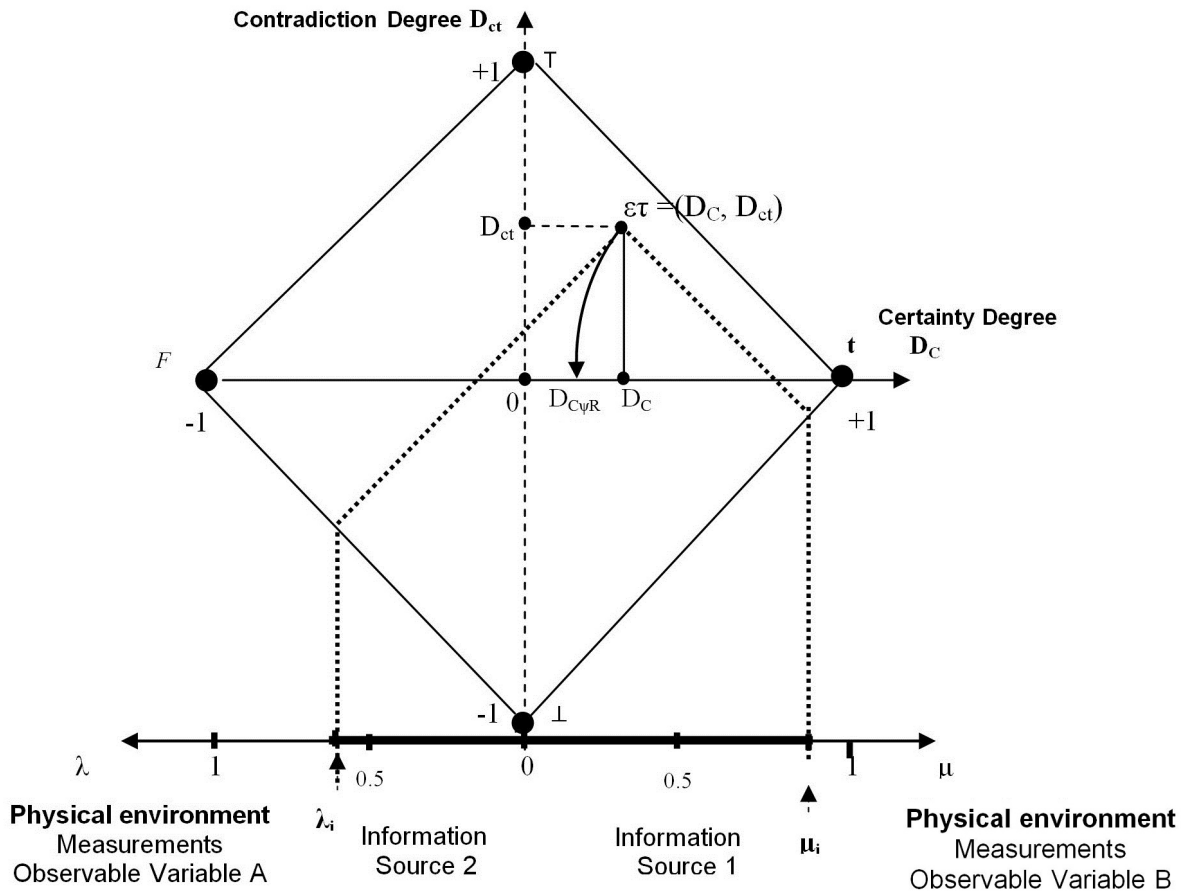

Figure 4. Representation of a Paraconsistent Logical State in to Lattice.

3.5. Algorithms of the Paraconsistent Logics

With the considerations here presented we can compute values using the equations obtained from the analysis and interpretations of the paraconsistent logics PAL2v where a paraconsistent analysis system receives information signals in the form of values of evidence degrees which vary from 0 to 1.

Through the algorithms, a paraconsistent analysis system can be built and it is capable of offering a satisfactory response from information extracted from the databank of uncertain knowledge. In this work we use 3 types of algorithms based on the PAL2v according to the following descriptions.

3.5.1. Evidence Degree Extracting Algorithm

The paraconsistent system for treatment of uncertainties may be used in many fields of knowledge where incomplete or contradictory information will receive an adequate treatment through the equations of the PAL2v. For this, the signals which will represent the evi-

dence in relation to the proposition in analyses must be normalized and all the processing will be done in real closed interval between 0 and 1 [9].

This process for modelling the evidence degrees with linear variation can be made in its simpler form with the algorithm that will be described in the next section [13-15].

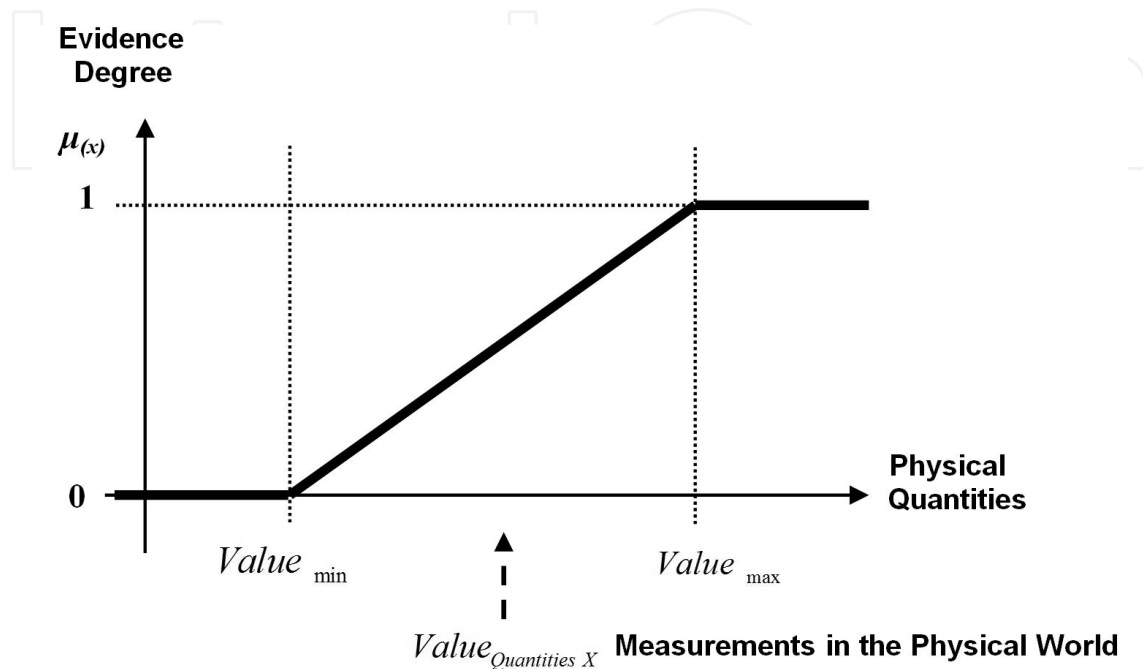

Figure 5. Graphical representation of the extraction of the Evidence Degree Algorithm - with characteristics of directly proportional variation.

3.5.2. Algorithm for Modelling/extraction of Evidence Degrees (Inputs of the PAL2v Algorithm)

3.5.2.1. Present the Maximum boundary-value to form the Discourse Universe.

$$Value_{max} = \dots\dots\dots (9)$$

3.5.2.2. Present the Minimum boundary-value to form the Discourse Universe.

$$Value_{min} = \dots\dots\dots (10)$$

3.5.2.3. Present the Value Measured of the Physical Quantities.

$$Value_{Quantities X} = \dots\dots\dots (11)$$

Obs: In real Physical System this value is obtained from measurements in sources of information.

3.5.2.4. Calculate the Favorable Evidence Degree μ through the equations:

$$\mu_{(x)} = \begin{cases} \frac{Value_{Quantities X} - Value_{min}}{Value_{max} - Value_{min}} & \text{if } Value_{Quantities X} \in [Value_{min}, Value_{max}] \\ 1 & \text{if } Value_{Quantities X} \geq Value_{max} \\ 0 & \text{if } Value_{Quantities X} \leq Value_{min} \end{cases} \quad (12)$$

3.5.2.5. Calculate the Unfavorable Evidence Degree λ by Complement of the Favorable Evidence Degree.

$$\lambda_{(x)} = 1 - \mu_{(x)} \quad (13)$$

3.5.2.6. Provide the outputs.

For information source 1: Do: $\mu = \mu_{(x)}$

For information source 2: Do: $\lambda = \lambda_{(x)}$

3.5.2.7. End.

Depending on the proposition to be analyzed and on the physical properties of the quantities from which the evidences are extracted, the variation between the maximum and minimum values at the extraction of the evidence degrees can be different such as: linear and inversely proportional characteristic, exponential characteristic, logarithmic characteristic, etc. In these cases, the equations of item 3.5.2.4 are modified according to the mathematical equation of the variables which express the characteristic line or curves used in the discourse universe.

3.5.3. Algorithm of paraconsistent analysis

The main PAL2v Algorithm used in paraconsistent analyses is the PAN- Paraconsistent Analyzer Node. In an Intelligent system that works with Paraconsistent Logic some PANs are linked forming uncertainty analysis networks (PANnet) for signal information treatments [14][15][16].

3.5.3.1. Paraconsistent Analysis Node - PAN

The element capable of treating a signal that is composed of one degree of favorable evidence and another of unfavorable evidence (μ_{1a} , μ_{2a}), and provide in its output a Resulting Evidence Degree, is called basic Paraconsistent Analysis Node (PANb).

Figure 6(b) shows the representation of a PANb with two inputs of evidence degree:

μ_1 = favorable Evidence Degree of information source 1.

λ = unfavorable Evidence Degree, where: $\lambda = 1 - \mu_2$

μ_2 is a favorable Evidence Degree of information source 2.

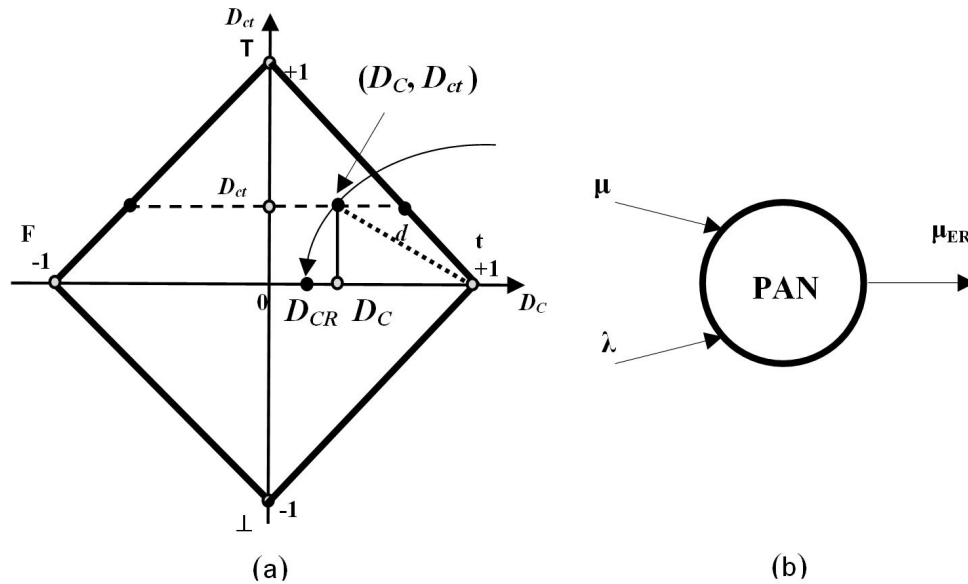

Figure 6. Finite Lattice of PAL2v and Symbol of the Paraconsistent Analyzer Node - PAN.

A lattice description uses the values obtained by the equation results in the Paraconsistent Analyzer Node Algorithm [3][13][14] that can be written in a reduced form, as follows:

1. Enter with the input values.

μ */ favorable evidence Degree $0 \leq \mu \leq 1$

λ */ unfavorable evidence Degree $0 \leq \lambda \leq 1$

2. Calculate the Contradiction Degree.

$$D_{ct} = \mu + \lambda - 1 \tag{14}$$

3. Calculate the Certainty Degree.

$$D_C = \mu - \lambda \tag{15}$$

4. Calculate the distance d of the Paraconsistent logical state into Lattice.

$$d = \sqrt{(1 - |D_C|)^2 + D_{ct}^2} \tag{16}$$

5. Compute the output signal.

If $d \geq 1$ Then do $S1 = 0.5$: Indefinite logical state and go to the step 10

Or else go to the next step

6. Calculate the real Certainty Degree.

If $D_C > 0$ $D_{CR} = (1 - d)$

If $D_C < 0$ $D_{CR} = (d - 1)$

7. Present the output.

Do $S1 = D_{CR}$

8. Calculate the real Evidence Degree.

$$\mu_{ER} = \frac{D_{CR} + 1}{2} \quad (17)$$

9. Present the output.

Do $S1 = \mu_{ER}$ and $S2 = D_{ct}$

10. End.

The Systems with the Paraconsistent Analysis Nodes (PAN) deal with the received signals through algorithms, and present the signals with a real evidence Degree value in the output [3].

3.5.4. Paraconsistent Algorithm Extractor of Contradiction Effects – $ParaExtr_{ctr}$

The Paraconsistent Algorithm Extractor of Contradiction effects ($ParaExtr_{ctr}$) is composed by connections among PANs. This configuration forms a Paraconsistent Analyze Network capable to extract the effects of the contradiction in gradual way of the signals of information that come from Uncertain Knowledge Database.

The hypothesis of extraction of the effects of the contradiction has as principle that; if the first treated signals are the most contradictory and then the result of the paraconsistent analysis will converge for a consensual value.

In his typical operation the $ParaExtr_{ctr}$ receives a group of signals of information represented by Degrees of Evidence (μ_E) the regarding certain proposition P and, independently of other external information, it makes paraconsistent analysis in their values where, gradually, it is going extracting the effects from the contradiction to remain as output a single resulting Real Evidence Degree μ_{ER} . The μ_{ER} is the representative value of the group of input signals after the process of extraction of the effects of the contradiction.

The figure 7 shows the representation of the algorithm Extractor of Contradiction effects that uses a network of three PANs.

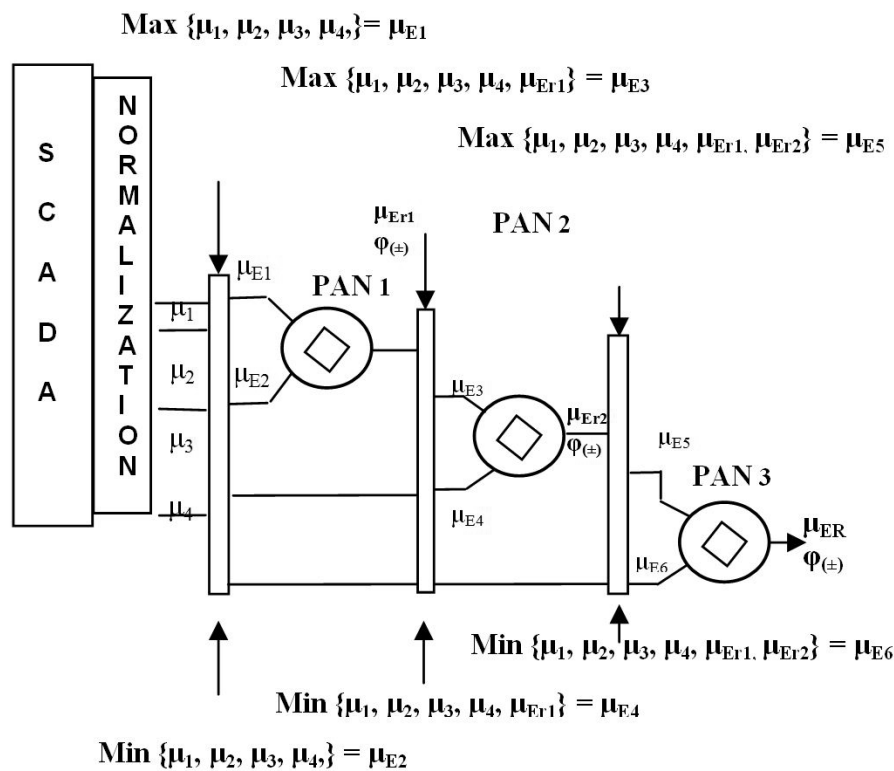

Figure 7. Paraconsistent Algorithm Extractor of Contradiction effects (ParaExtr_{ctr}).

The description of the *ParaExtr_{ctr}* Algorithm is shown to proceed.

1. Present n values of Evidence Degrees that it composes the group in study.

$$G\mu = (\mu_A, \mu_B, \mu_C, \dots, \mu_n) \quad */\text{Evidence Degrees } 0 \leq \mu \leq 1*/$$

2. Select the largest value among the Evidence Degrees of the group in study.

$$\mu_{\max A} = \max (\mu_A, \mu_B, \mu_C, \dots, \mu_n)$$

3. Consider the largest value among the Evidence Degrees of the group in study in favorable Evidence Degree.

$$\mu_{\max A} = \mu_{\text{sel}}$$

4. Consider the smallest value among the Evidence Degrees of the group in study in favorable Evidence Degree.

$$\mu_{\min A} = \min (\mu_A, \mu_B, \mu_C, \dots, \mu_n)$$

5. Transform the smallest value among the Evidence Degrees of the group in study in unfavorable Evidence Degree.

$$1 - \mu_{\min A} = \lambda_{\text{sel}}$$

6. Make the Paraconsistent analysis among the selected values:

$$\mu_{R1} = \mu_{\text{sel}} \diamond \lambda_{\text{sel}} \quad */ \text{ where } \diamond \text{ is a paraconsistent action of the PAN } */$$

7. Increase the obtained value μ_{R1} in the group in study, excluding of this the two values μ_{max} and μ_{min} , selected previously.

$$G\mu = (\mu_A, \mu_B, \mu_C, \dots, \mu_n, \mu_{R1}) - (\mu_{maxA}, \mu_{minA})$$

8. Return to the item 2 until that the Group in study has only 1 element resulting from the analyses.

Go to item 2 until $G\mu = (\mu_{ER})$

4. The Paraconsistent Logical Model of The Expert System (PES_{PAL2v})

An expert system is designed and developed to attend a certain and limited application of human knowledge. Moreover, equipped with an information base, it must be capable of providing a decision based on justified knowledge. Doing so, the algorithms which compose the computational programs of the expert system need to represent knowledge from the domain they have to analyze and assist the user in solving problems.

The precision of the results depends on the capability of knowledge acquisition and transference methods of this information through a computational language which can be accordingly treated and on returning a consistent response.

Following this model, the application of the paraconsistent logics PAL2v in the analysis of electric power systems is done with the reception of data corresponding to the values of voltage and current captured by the SCADA system where they are normalized in order to be adjusted to the concepts of the PAL2v. These signals receive adequate treatments by the PAN algorithms in their normal configuration or interconnected, composing networks of blocks which extract the contradiction effects building a paraconsistent logical model related to the risk state of overload on the system.

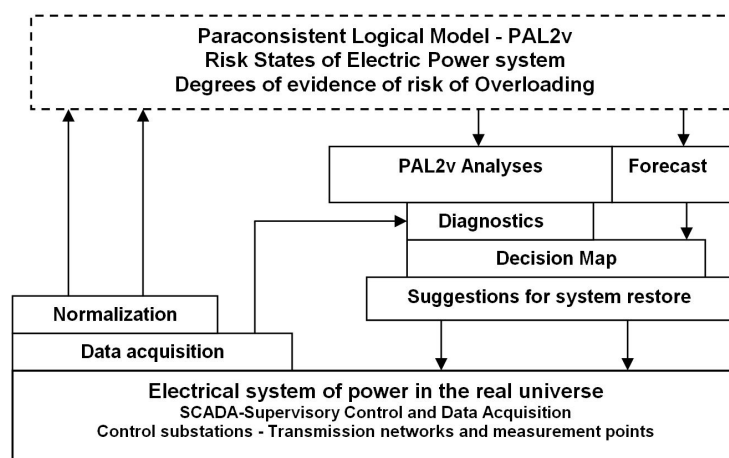

Figure 8. Paraconsistent logical model composed by risk evidence degrees obtained with values of current and voltage captures in the real electric power system.

According to the paraconsistent expert system (PES_{PAL2v}) the real electric power system in operation owns its paraconsistent logical model based on evidence degrees whose propositions are related to states of outage risks by overloading.

Figure 8 shows the paraconsistent logical model composed by risk evidence degrees configured by the real electric power system.

4.1. Contingency Analysis for Electric Power Systems Using Paraconsistent Logics

The operation of the PES_{PAL2v} starts when there is the occurrence of a contingency or failures with electric power outage. This is when the algorithms of the Paraconsistent Expert System receive data for analysis of pre-failure states which were stored in the SCADA system database. This allows the PES_{PAL2v} to check the risk degrees of overloading with measures of voltage and current before the occurrence. The verification of the resultant evidence degrees detects with a certain evidence degree which branch of the power network had a high overloading degree risk before the occurrence.

This pre-failure analysis offers conditions such that at the time of contingency we can compare the obtained evidence degree of overloading risk with the risk state that the system had in the condition previous to the event. So, it is possible, through the results from the comparative analysis between the two moments and the condition of the topology of the electric network in its area affected by the contingency that the PES_{LPA2v} can do the most convenient adaptation of maneuvers to be applied to the optimized restoring of the electric power system.

According to the results of the comparisons among the evidence degrees of overloading risk, the analysis of the paraconsistent expert system PES_{PAL2v} will suggest control actions to the restoring of the electric power system based in three states of the sub-transmission system [13].

These analysis procedures can be seen on Figure 9.

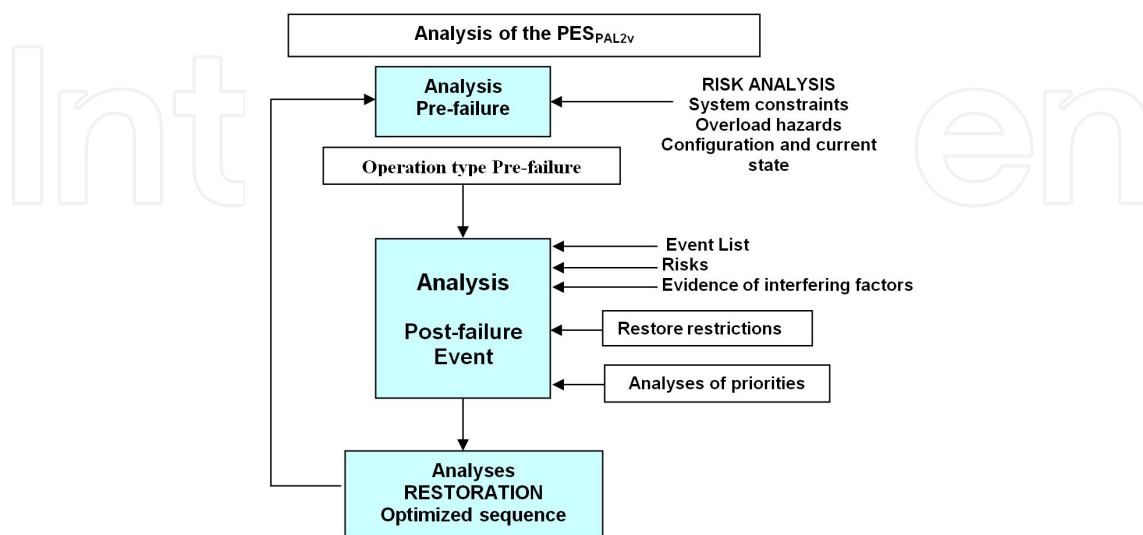

Figure 9. Flowchart of the analysis states in the process.

1. Pre-failure – consists in the analysis of the sub-transmission system in operation.
2. Post-failure – consists in the analysis of the sub-transmission system at the instant of the contingency.
3. Restoring – consists in the analysis of the sub-transmission system after the contingency.

4.1.1. Propositions Used in the Paraconsistent analysis

The paraconsistent analysis in the PES_{PAL2v} is based on the configurations of the PANs where the paraconsistent logical signals are extracted from measured values of voltage and electric current. The PAL2v analysis is performed with applied paraconsistent logical signals with annotations composed of evidence degrees related to 5 partial propositions.

The two first analyze the tension outage and overcurrent at the measurement points and generate evidence degrees related to the existence of overloading in the sub-transmission network. They are:

Pp1: There is overcurrent in the electric power network

Pp2: There is sub-voltage in the electric power network

Next, through the PANs algorithms, the paraconsistent analysis with the degrees of sub-voltage and overcurrent generated by this initial analysis which result evidence degrees, now related to the annotation of the object proposition:

Po: There is the risk of drop by overload in the electric power network.

For the decision-making about the optimized restoring of the sub-transmission system after a contingency, PES_{PAL2v} still analyzes other two propositions related to the restrictions and the topology of the power network:

Po1: There are restrictions of loads in the electric power network.

Po2: The network topology is ideal for the current situation.

That being so, the sequence of maneuvers which are offered to the operation will be conditioned directly to the configuration of topologies, technical norms and restrictions which involve the area of the sub-transmission system of the power network affected by the contingency.

The classification performed by the paraconsistent analysis network (PANet) generates a resulting evidence signal whose value will define the type of operation and sequences of restoring closest to the ideal, given the conditions of the sub-transmission system.

Figure 10 shows the pre-failure analysis with its partial propositions which generate the evidence degrees for its object proposition and whose result will be used for the post-failure analysis.

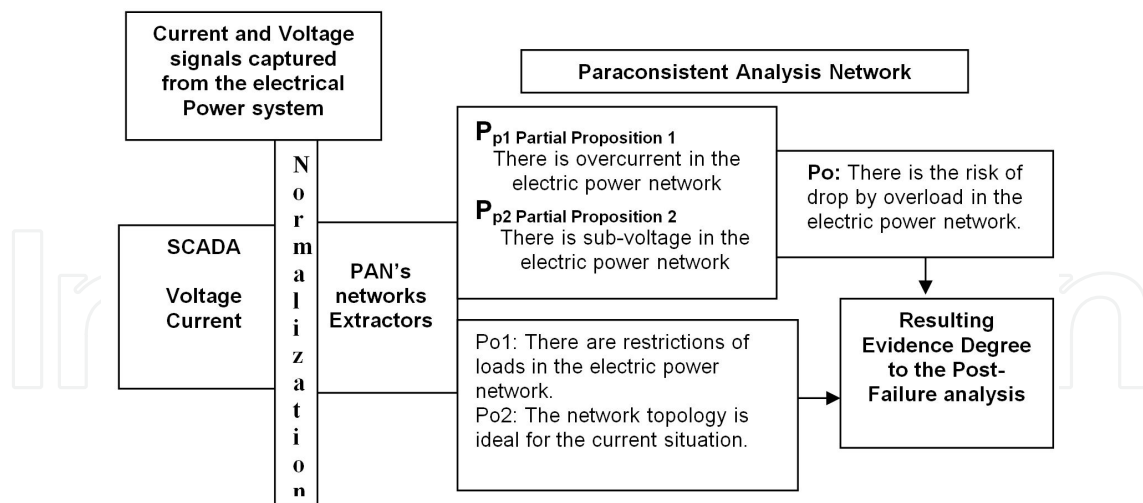

Figure 10. Representation of the pre-failure analysis with its partial prepositions which generate evidence degrees for the post-failure analysis.

5. Project of the Paraconsistent Expert System - PES_{PAL2v}

The project of PES_{PAL2v} starts with the definition of the methods of acquisition of data through the evidence degree extracting algorithms with the goal of generating the paraconsistent logical signals for the analysis network composed of algorithms based on the PAL2v.

5.1. Acquisition of Measurements

The first task to be performed by the paraconsistent expert system PES_{PAL2v} is the acquisition of values of measurements performed in the system so that the overload risk levels can be detected. For this purpose, we use the data available in the SCADA (Supervisory Control and Data Acquisition) system which, in this phase, has to receive several types of measurements from the field.

The SCADA system is responsible for the interface between the measurements of electric quantities and the communication network interconnected to the analysis systems.

5.1.2. Block Diagrams of Primary Signals

The measurements required by SCADA and stored into database are performed by the remote stations RTU (Remote Terminal Units) and / or by signal capturing devices IED (Intelligent Electronic Devices). In the practice due to the unbalancing of loads, errors in measurements performed by SCADA and other factors which influence the electric system, it is verified that the amplitude values of quantities of interest (voltage and current) are different among the three phases of the transmission line.

This condition shows that the measured values bring contradiction levels among them right from the origin. So, in order to obtain reliable values in the signal treatment of the Paracon-

sistent Expert System -PES_{PAL2v}, the primary values receive an initial treatment of contradiction extraction.

Considering this condition, the extracting block of primary signals uses algorithms capable of extracting evidence degrees and of extracting contradiction effects, as shown on Figure 11.

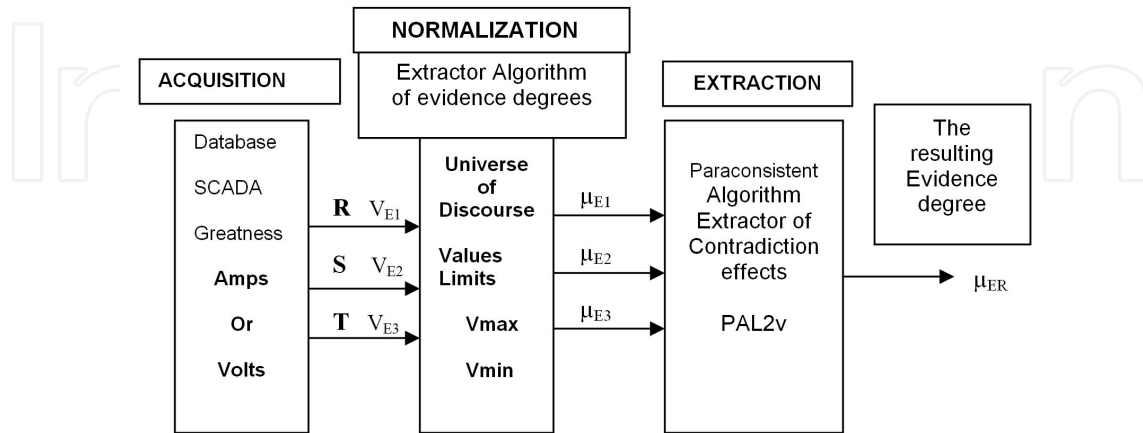

Figure 11. Block diagram which extracts primary evidence signals related to the sub-voltage and overcurrent on the measurement point.

The maximum and minimum values of the discourse universe of the evidence degree extracting algorithm are particular to each load connected to the corresponding breaker at the substation of the electric power transmission line.

The evidence degree extracting system receives the three values of voltage (or current) corresponding to the three phases of the line (RST) which are transformed in evidence degrees by a normalization defined by the interest interval or discourse universe. After this first process, the three resulting values pass through a contradiction effect extracting algorithm which outputs a unique resulting evidence degree.

5.2.3. Evidence Degree Extraction at an Operating Substation

PES_{PAL2v}'s project was carried out in order to perform analysis of overload risks through the applications of the algorithms of the PAL2v on monitoring essential points available at the operating substations of the sub-transmission electric system.

The buses that interconnect the several equipments installed at a substation such as transformers, electric keys and breakers of the sub-transmission system are points where voltage and current can be measured for each one of the loads interconnected by the breakers. In an operating substation a sub-voltage evidence degree and an overcurrent evidence degree are extracted from each breaker which activate loads at an operating substation.

Based on these values, the modules composed by the algorithms of the PAL2v verify the state of that point with respect to tension decreasing and excess of current intensity which together contributes to the increase of the overload risk at the point measured. After the extraction of the evidence degrees of sub-voltage and overcurrent from the load breaker, these

two signals become input to a contradiction effect extracting algorithm outputting an evidence degree of overload risk at the measurement point.

Figure 12 shows the evidence degree of overload risk extracted from a measure point of the breaker (Load 16) of a typical substation of the sub-transmission system.

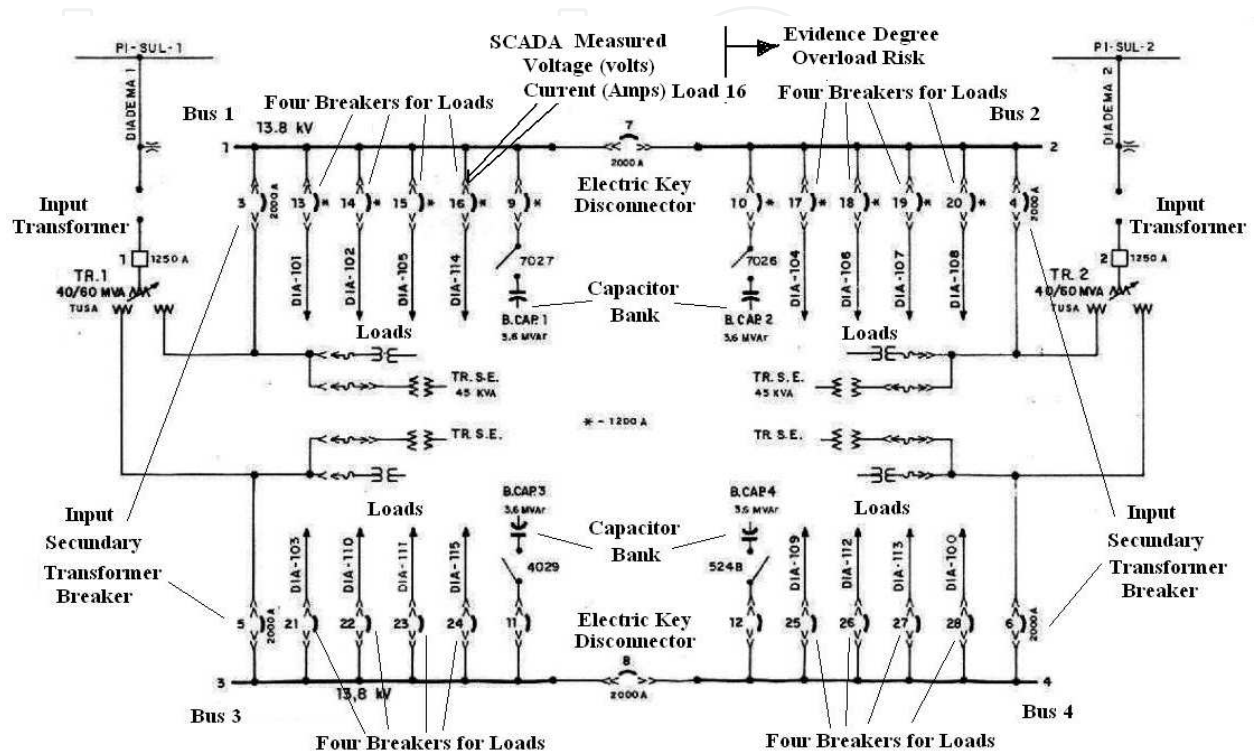

Figure 12. Overload Risk degree extraction from the breaker of load 16.

The operating substation seen on the figure 12 is composed by two buses shown horizontally where a total of 16 load control breakers are interconnected. Each breaker controls its correspondent load and are sources of extraction of evidence degrees for the paraconsistent analysis. In each one of the two buses there are 8 load breakers combined, however when a disconnector or electric key is open, it separates two buses with 4 breakers for each one.

Other breakers which control the feeding of the input transformers of the substation and the capacitor bank are also measurement points from where the evidence degrees of overload risk at the operating substation.

5.3. Extracting Module of Evidence Degrees from the Interconnection Buses

The extracting module of resulting risk evidence degree uses the contradiction effect extracting algorithm so it can receive n evidence degrees from several breakers which are interconnected to the same bus. That being, the PAL2v analysis can offer a unique representing value of the evidence degree of the bus.

Figure 13 shows a general diagram of capture of the resulting evidence degree of a bus at a typical operating substation shown in the previous picture which is composed by four breakers.

Through amplitude signals of the quantities received by the extraction modules of primary signals, and the signal which represents the state of the breaker key, each breaker has its evidence degree of risk which will be treated by the final module, resulting in a unique value of evidence degree of overload risk on the buses.

5.4. Paraconsistent Logical Model of Operating Substation

Using contradiction effect extracting blocks a paraconsistent logical model of operating substation can be created encompassing the evidence degree of overload risk of all possible points to be monitored.

In the typical operating substation the goal is to obtain the degree of overload risk generated by the four buses. So, from the models of the main devices installed in a typical substation, a paraconsistent modeling for the whole substation was designed.

First the overload risks at a typical substation were classified in four types:

1. Risks of overload on the buses (μ_{Ebus}).
2. Risks of load transfer (μ_{ETRANS}).
3. Risks of overload on the secondary windings (μ_{ESec}).
4. Risks of overload on the primary windings (μ_{EPRIM}).

The resulting evidence degree of overload risk of the substation is then obtained by the paraconsistent analysis performed among these four values extracted from the model.

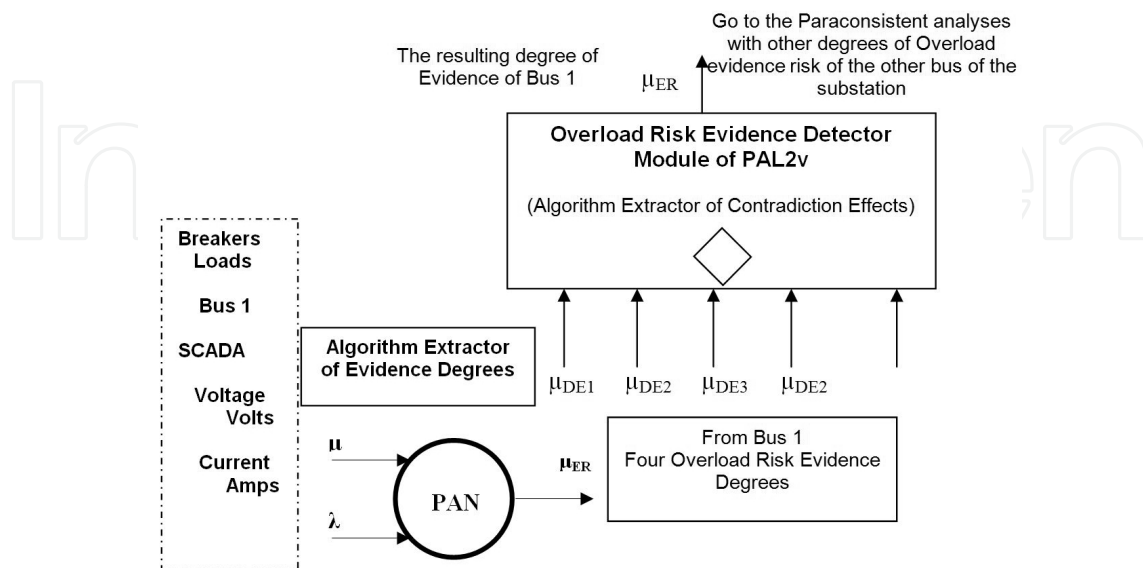

Figure 13. Diagram of capture of evidence degree of risks from a typical bus of a substation.

5.5. Computing the total resulting evidence degree of overload risk of the substation

After obtaining the evidence degree of overload risks the model for restoring control was developed. This model has as its goal to analyze and present optimized restoring procedures for the transmission of electric power after a contingency.

5.5.1. Restoring control actions

The restoring of an electric power system is a very complex procedure because it involves several activities which include: steps for previous study until steps of decision-making under intense emotional stress by the operators. The goal of the restoring control is to carry out the prompt restoration of the electric power system taking it to the condition of normal operation, where the load is attended and the operating limits are observed.

In the practice the reconnection procedure must be carried out by taking several precautions in order to suit all restrictions which take the new system state to a better level than that one which caused the disconnection. In order to start the actions of the restoring control, it is necessary to have full knowledge of the current situation of the electric system. The most important items which must be in the knowledge base of the model are:

- a. Knowledge about the part of the electric power system which was disconnected.
- b. Knowledge about the parts of the electric power system which were affected by the failure.
- c. Knowledge of the source and cause of the disconnections, detecting what caused the disconnection with the best precision possible.
- d. Knowledge of the existence of real conditions for the reconnection with the verification of the following situations:

If the source of the failure is a permanent failure that prevents from reconnecting.

If the disconnection happened from previously established emergency control actions. In this case the electric power system is known to have programmed "islands" which will make the restoring process easier.

If there are previously established control actions. This is a situation which happened when the emergency control takes the energy system to a condition known by previous studies.

5.6. Restoring Plans

The restoring plans have detailed actions by means of operation instructions which must be carried out by the operator in order to reconnect the electric power system. The strategy of these plans is based on the division of the procedures in steps in order to obtain a larger decentralization of the recombination actions. In the development of the Paraconsistent Expert System - PES_{PAL2v}, the model of restoring control was designed to present actions based on

the evidence degrees of overload risks obtained by the paraconsistent analysis on several points of the electric power system.

The reconnecting maps were done based on operational norms and restrictions of each substation and sequences of optimized restoring were established taking into consideration the values of risk degrees of overload before and after the contingency.

6. Implementation and Testing of the Paraconsistent Expert System - PES_{PAL2v}

The paraconsistent expert system PES_{PAL2v} was implemented to carry out analysis of the types of disconnection through information received by codes of the SCADA system and add this information to the restoring plan of the electric power system of an area being studied belonging to the AES-Eletropaulo Company which is an electric power concessionary company of Brazil.

The prototype was implemented on JAVA platform and tests with real values, which were extracted from the electric power lines of an area considered as a pilot and were stored in a history database, were carried out.

The project was in its first version developed so that the prototype PES_{PAL2v} performs off-line, however, with the information and data from events which represent real situations occurred in the area under study in the years 2007 and 2008. The pilot area, where the PES_{PAL2v} was tested with respect to its action analysis of overload risk and suggestions for the restoring, is composed by three OSs (operating substation), twelve TDSs (transformation and distribution station), twelve STCs (station of transformation to the consumer), three CBEs (capacitor bank station) and several aerial and underground lines.

The decision-making process of the SEP_{PAL2v} was designed through the acquisition of knowledge from the operators responsible for the electric operation in this area. When a contingency occurs, SEP_{PAL2v} receives the evidence degrees of overload risk through its paraconsistent logical model, performs a diagnosis and activates a flowchart with later available resources in performing the emergency maneuvers in the AES-Eletropaulo electric network considered as pilot.

6.1. Modeling and preparation of primary signals

Initially a large amount of data of the SCADA system related to that period was modeled to prepare the signals which are input to the prototype PES_{PAL2v} . The data stored in the SCADA system were modeled by creating two databases: the database of quantity values which will be called Database 1 and the database of alarms which will be called Database 2, as shown in Figure 14.

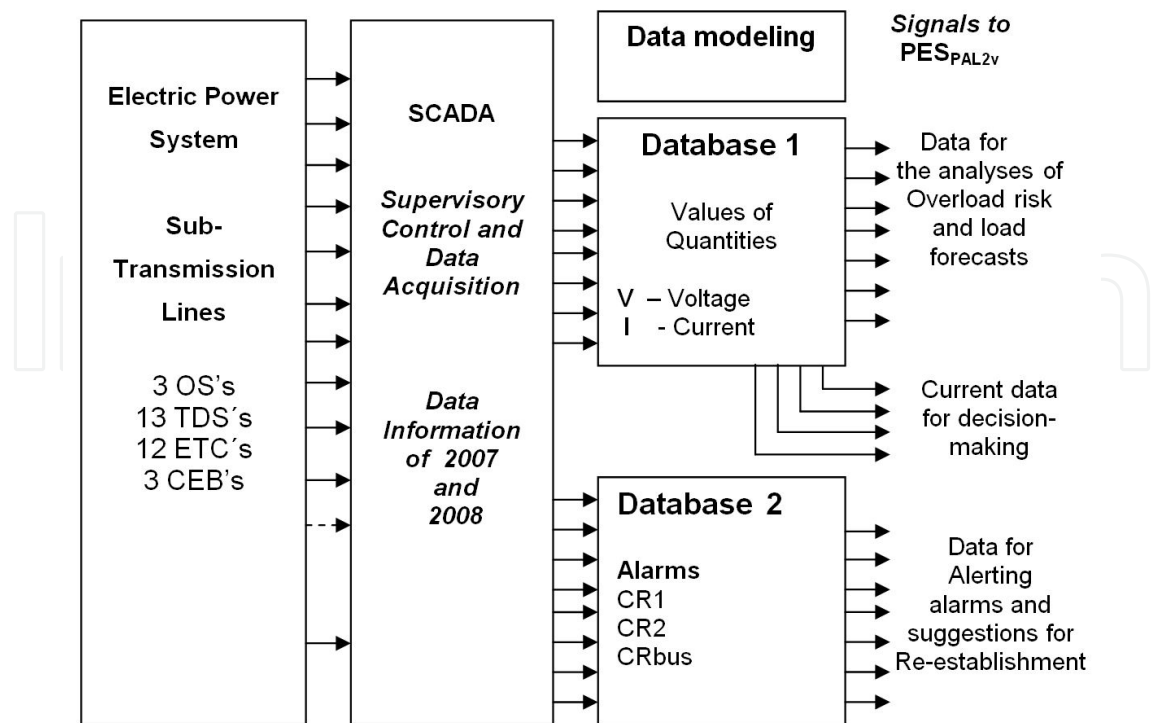

Figure 14. Initial data modeling diagram of the SCADA system.

Database 1 – Quantity values

After the data modeling of the SCADA system database 1 stores information about, besides those which identify the substation, breakers and other equipment and their measurements of amplitude of tensions and currents. The detections are so that in a time interval(Δt) PES_{PAL2v} is provided with measurements of intensities of currents in each load of the substation and the measurements of amplitude of tension on the buses in each stage of the load feeding, secondary an primary windings of the transformers.

Database 1 provides data for risk analysis that are the intensity of current of loads on the three buses (IA, IB, IC) and the amplitudes of tension of the bus on the three phases (VR, VS, VT). These values receive a paraconsistent logical treatment by PES_{LPA2v} such that the contradiction effects are decreased or totally excluded. Such contradictions are due to measurement mistakes inherent to the SCADA system. This treatment of the primary signals is performed by the special modules of capture and modeling.

Database 2 – Alarms

After the data modeling of the SCADA system database 2 stores information about, besides those which identify the substation, breakers (and other equipment), and types of classification of the alarms occurred in the events. The detections are so that in a time interval (Δt) PES_{PAL2v} is provided with the types of alarms that occurred in the installed component in the substation including the action of the relay keys (RC) with the types which classify the activated alarm: CR1, CR2 or Crbus.

Database 2 provides data for two purposes:

a) *Data for detecting the topology* - The data stored in the Database 2 represent the state (on or off) of the breakers and splitting keys. The signal of these states provides an overview of the topology of the substation which is transferred as evidence to the paraconsistent models of the breakers. The evidence degrees resulting from this analysis will influence the process of restoring suggestion generated by PES_{PAL2v} .

b) *Data for detecting the occurrence type* - The data stored in the Database 2 provide the alarm type and corresponding classification of the disruptions through several codes which are inserted on the restoring map of operating substation. The classification of the types of occurrences, together with the risk analysis signal PES_{PAL2v} the activation of the flowchart corresponding to the restoring map of the area affected by the contingency.

Figure 15 shows the signal flow where Database 1 and 2 are related with the modules of risk analysis, previewing and diagnosis.

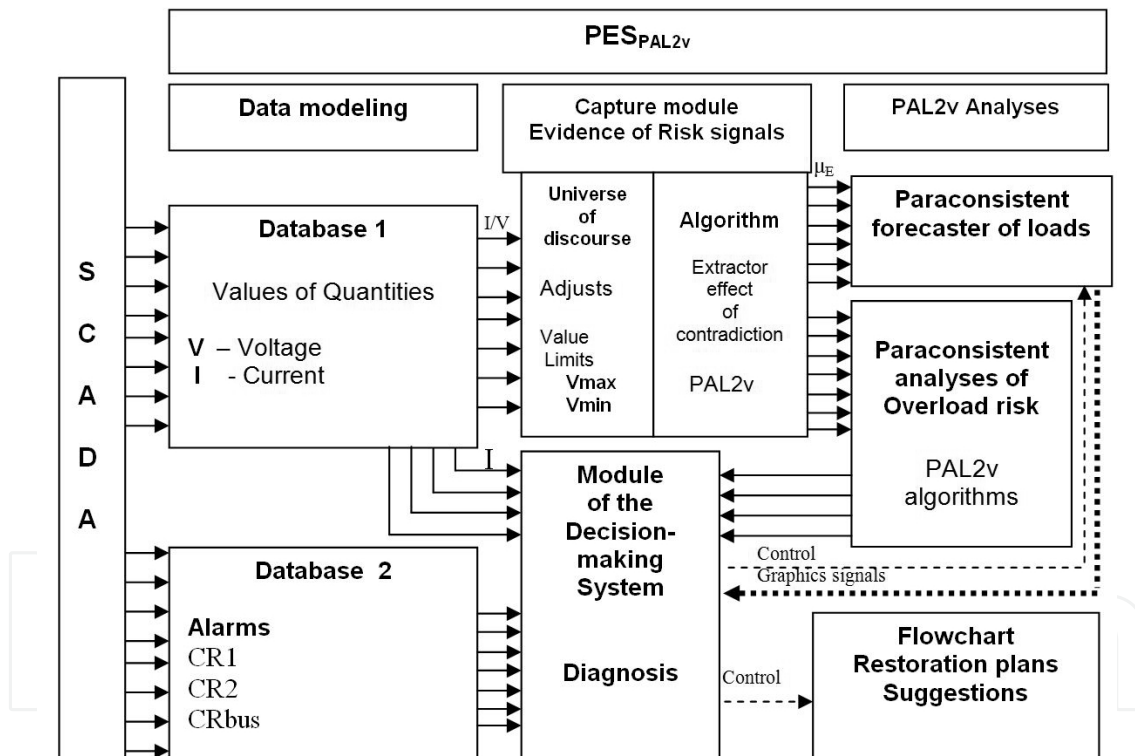

Figure 15. Signal flow between Database 1 and 2 and modules of paraconsistent analysis.

The decision-making module receives three types of signals: the values of intensities of the currents of the load (I) directly from Database 1; the values of the evidence degrees (μ_{ER}) from the paraconsistent analysis of overload risk; and signals from Database 2 related to the alarm types of occurrences. The analysis of these three signals results a diagnosis which activates a flowchart of restoring plan and the interaction with the user to find the best way to carry out the system restoring.

Based on the flowchart the steps for the restoring are following according to the diagnosis made based on the analysis which encompasses the classification of the alarm type, the values in engineering units of the measurements of currents and tensions, the risk evidence degrees obtained by the paraconsistent analysis carried out.

6.2. Verification of values on working screens

PES_{PAL2v} has working screens where one can check the efficiency of the installed paraconsistent algorithms and the monitoring on each essential point of the substation.

Figure 16 below shows the values exposed on the screen of a typical substation (called “Diadem”) used in the pilot system. On the screen one can see the evidence degrees of overload risks on all measurement points of the operating system being analyzed.

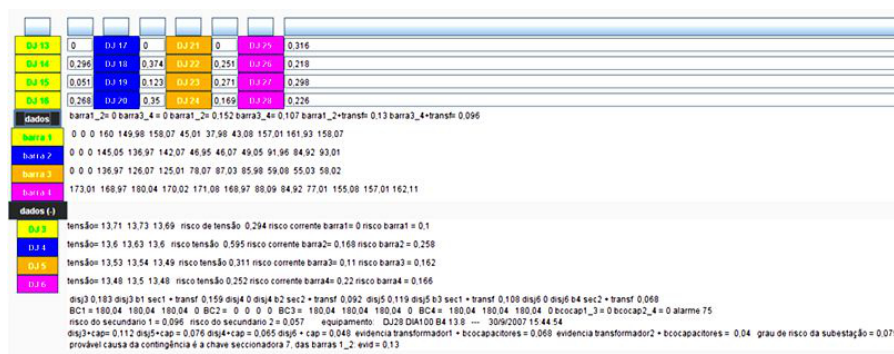

Figure 16. Working screen: significant values obtained from the Substation Diadema.

6.2.1. Denormalization Process

All the procedures for the analysis were carried out by the algorithms which were based on the PAL2v whose signal treatment considers normalized values, that is, values in the closed interval [0,1] of real numbers. In order to obtain previewing values in units of engineering, recovering the approximate values of current intensity and voltage, it is necessary to perform a denormalization process of the obtained values.

6.3. Tests and description of the application PES_{PAL2v}

The application of the Paraconsistent Expert System - PES_{PAL2v} in this version can work in two modes according to the user: “Analysis” mode and “Training” mode. These two modes are described in what follows.

a) When the “Analysis” mode is selected, the Paraconsistent Expert System - PES_{PAL2v} performs the analysis of overload risks, outputs the values of the risk degrees, current intensity and the breakers which are off. Next, the system interacts with the user and suggests

optimized procedures for reconnecting. The suggestions are done in an interactive way through descriptions, visualization of the flowchart of the reconnecting maps and other restriction graphs.

b) When the mode “Training” is selected, the Paraconsistent Expert System - PES_{PAL2v} will simulate the failure and step by step will present details about the procedures of the reconnecting flowchart. In order to begin the process the user has to inform the application the name of the substation he or she wants to simulate.

When this information is input, the application shows on the reserved space at the left of the screen the unifilar representation of the selected substation. The next step is the user’s action which selects the breakers which will be simulated as “off” in order to configurate a type of failure occurrence.

When the simulation process is started the application, based on the breakers selected as “off” by the user, detects the type of alarm (CRs) which represents the disconnections and performs a search on the substation’s database for the date that such failure occurred.

When the date of the occurrence is detected the application activates the networks of paraconsistent analysis obtaining the evidence degrees of overload risk and other specific information together with the first suggestions from the flowchart of the reconnecting map.

The interactive process is similar to the one presented in the “Analysis” mode: the suggestions and actions already determined by the flowchart will be step by step presented until the end of the optimized reconnecting. Doing so, the training is totally performed from real data of failure occurrences represented by values stored in the database.

Figure 17 shows a screen of an operating substation in its unifilar diagram with all available values obtained by the paraconsistent analysis. A menu, where restoring sequences of the electric power system after a contingency, is shown to the user.

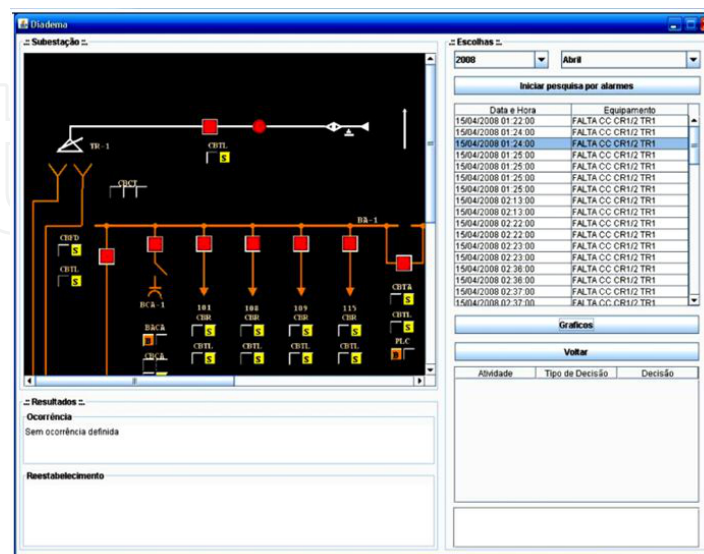

Figure 17. Analysis screen – Unifilar diagram and menu with information generated by PES_{PAL2v}.

7. Conclusion

In this work it was shown that the paraconsistent logics has a great capability of application in technological processes with the aim to solve complex problems. The Paraconsistent Expert System - PES_{PAL2v} was designed with an analyzing block of contingency which is capable of computing the risk degrees of outage by overloading of the electric power system. Moreover, given such occurrence, it is also capable of analyzing the conditions and of offering a list of sequences of optimized restoring for the operation.

Currently the expert system built with the PAL2v is being used to assist operation and training of operators at the operational substations of the electric power system of the AES-Eletropaulo – electric utility in Brazil. In the practice the paraconsistent expert system PES_{PAL2v} has shown to be an efficient tool, with which the user understands and accepts the reasoning methods used in the problem solving, since paraconsistent logics are more intuitive and has algorithms with simple structure. Generally speaking, it reached the following goals:

- a. Assist the operator in the selection of the main control actions at the time of the restoring.
- b. Outline and implement restoring plans based on the operational state of the electric system.
- c. Show the restoring state in its optimized form.

Together to the above three main features, we can add three more:

- d. Promote the operators' training.
- e. Optimize the restoring process.
- f. Detect "islands" – areas that due to disconnection remained isolated.

In operation, the PES_{PAL2v} has shown to be computational software where the modulation parameters are easy to adjust and the analyzing block of contingencies is adapted to provide resulting information in a satisfactory way. It was tested under several conditions using real values which were stored into a database for 12 months.

The sub-transmission system which was tested was composed of 12 substations where it was possible to modify and test several topological configurations. Under all tested conditions, PES_{PAL2v} showed good results and responded well to various situations in comparison to previous situations which were also stored into database.

The prototype application build in this first phase leave the necessary conditions fulfilled, so that the analysis process can be automatically started for the online implementation, topic which is for future projects. In this case, the alarms activated due to failures at the substations whose data were stored in the database, will start the application so that the analysis phases of the process are started in real-time. Under these conditions PES_{PAL2v} will with no doubt a very useful tool to the operation of the electric power system.

With this work it was shown that an expert system can be built with the algorithms of the paraconsistent logics and is capable of performing its fundamental task of analyzing contradicting information. Moreover, it is also capable to clearly show the user the reasoning methods it is using, so that the user can interact with the system with high confidence degree.

Author details

João Inácio Da Silva Filho^{1*}, Alexandre Shozo Onuki¹, Luís Fernando Pompeo Ferrara¹, Maurício Conceição Mário¹, José de Melo Camargo², Dorotéa Vilanova Garcia¹, Marcos Rosa dos Santos² and Alexandre Rocco¹

*Address all correspondence to: inacio@unisanta.br

1 UNISANTA - Santa Cecília University, Brazil

2 AES - Eletropaulo Metropolitan Eletricidade de São Paulo S.A, Brazil

References

- [1] CIGRE. (1993). Practical use of expert systems in planning and operation of power systems. TF 38.06.03, *Électra*, (146), 30-67.
- [2] Paris, L., et al. (1984). Present Limits of Very Long Distance Transmission Systems. *CIGRE. Global Energy Network Institute*, Retrieved 2011-03-29.
- [3] Donald, G. Fink., & Beaty, Wayne H. (2007). *Standard Handbook for Electrical Engineers (15th Edition)*, McGraw-Hill, 978-0-07144-146-9, section 18.5.
- [4] Lynne, Kiesling. (2003). Rethink the Natural Monopoly Justification of Electricity Regulation. (August 18). Reason Foundation. Retrieved January 31, 2008.
- [5] Da Silva Fiho, J. I., Lambert-Torres, G., & Abe, J. M. (2010). Uncertainty Treatment Using Paraconsistent Logic- Introducing Paraconsistent Artificial Neural Networks. *IOS Press*, 328, 211, *Frontiers in Artificial Intelligence and Applications*, Amsterdam, Netherlands.
- [6] Da Silva Filho, J. I., Mário, M. C , Pereira, C. D. S. , Angari, A. C. , Ferrara, L. F. P. , Pitoli, O. Jr. , & Garcia, D. V. (2011). An Expert System Structured in Paraconsistent Annotated Logic for Analysis and Monitoring of the Level of Sea Water Pollutants. *Expert Systems for Human, Materials and Automation*, Prof. PetricĂf Vizureanu (Ed.), 978-9-53307-334-7, InTech.
- [7] Hughes, Thomas P. (1993). *Networks of Power: Electrification in Western Society, 1880-1930*, Baltimore: Johns Hopkins University Press, 119-122, 0-80184-614-5.

- [8] Dieter Betz, Hans, Schumann, Ulrich, & Laroche, Pierre. (2009). *Lightning: Principles, Instruments and Applications*, Springer, 202-203, 978-1-40209-078-3, Retrieved on May 13.
- [9] Da Silva Filho, J. I., Rocco, A., Mario, M. C., & Ferrara, L. F. P. (2006). Annotated Paraconsistent logic applied to an expert System Dedicated for supporting in an Electric Power Transmission Systems Re-Establishment. *IEEE PES- PSC 2006 Power System Conference and Exposition*, 212-220, 1-4244-0178-X, Atlanta, USA.
- [10] Da Silva Filho, J. I., Rocco, A., Mario, M. C., & Ferrara, L. F. P. (2007). PES- Paraconsistent Expert System: A Computational Program for Support in Re-Establishment of The Electric Transmission Systems. *Proc. of LAPTEC 2007- VI Congress of Logic Applied to Technology*, 217, 978-8-59956-145-4, Santos, SP, Brazil, Nov.
- [11] Da Silva Filho, J. I., Rocco, A., Onuki, A. S., Ferrara, L. F. P., & Camargo, J. M. (2007). Electric Power Systems Contingencies Analysis by Paraconsistent Logic Application. *Proc. of ISAP 2007- 14th International Conference on Intelligent System Applications to Power Systems*, 112-117, Kaohsiung, Taiwan, Nov.
- [12] Da Silva Filho, J. I., & Rocco, A. (2008). Power systems outage possibilities analysis by Paraconsistent Logic. *Power and Energy Society General Meeting- Conversion and Delivery of Electrical Energy in the 21st Century, IEEE*, 978-1-4244-1905-0, 1932-5517, 1-6, Pittsburgh, PA.
- [13] Torres, C. R., Abe, J. M., Lambert-Torres, G., & Da Silva Filho, J. I. (2011). Autonomous Mobile Robot Emmy III. *Mobile Robots- Current Trends*, Dr. Zoran Gacovski (Ed.), 978-9-53307-716-1, InTech.
- [14] Da Costa, N. C. A., & Marconi, D. (1989). An overview of Paraconsistent logic in the 80's. *The Journal of Non-Classical Logic*, 6, 5-31.
- [15] Da Costa, N. C. A. (1974). On the theory of inconsistent formal systems. *Notre Dame J. of Formal Logic*, 15, 497-510.
- [16] Da Costa, N. C. A., Abe, J. M., & Subrahmanian, V. S. (1991). Remarks on annotated logic. *Zeitschrift f. math. Logik und Grundlagen d. Math*, 37, 561-570.
- [17] Subrahmanian, V. S. (1987). On the semantics of quantitative logic programs. *Proc. 4th. IEEE Symposium on Logic Programming, Computer Society Press, Washington D.C.*
- [18] Pereira, J. A. (2001). State Estimation Approach for Distribution Networks Considering Uncertainties and Switching. *PhD Thesis, FEUP, Porto, July.*
- [19] Schulte, R., Sheble, G., Larsen, S., Wrubel, J., & Wollenberg, B. (1987). Artificial Intelligence Solutions to Power System Operating Problems. *IEEE Trans. On Power System*, Pwrs-2(4), Novembro de.
- [20] Herbronn, B., Correa, J., Fandino, J., Hayashi, T., Kato, M., Krishen, D., Knight, U., Krost, G., Manolio, R., Matsumoto, K., Partanen, J., & Reichelt, D. (1993). A Survey of Expert Systems For Power System Restoration. *Electra* [No 150], Outubro de.
- [21] Adibi, M., Clelland, P., Fink, L., Happ, H., Kafka, R., Raine, J., Scheurer, D., & Trefny, F. (1987). Power System Restoration- A Task Force Report. *IEEE Trans. On Power System*, Pwrs-2(4), Maio de.

