

We are IntechOpen, the world's leading publisher of Open Access books Built by scientists, for scientists

4,800

Open access books available

122,000

International authors and editors

135M

Downloads

Our authors are among the

154

Countries delivered to

TOP 1%

most cited scientists

12.2%

Contributors from top 500 universities

**WEB OF SCIENCE™**Selection of our books indexed in the Book Citation Index
in Web of Science™ Core Collection (BKCI)

Interested in publishing with us?
Contact book.department@intechopen.com

Numbers displayed above are based on latest data collected.

For more information visit www.intechopen.com

Wireless Sensors Network Application: A Decentralized Approach for Traffic Control and Management

Faisal Ahmed Al-Nasser and Magdi S. Mahmoud

Additional information is available at the end of the chapter

<http://dx.doi.org/10.5772/48212>

1. Introduction

Wireless sensor networks (WSNs) are a significant technology attracting considerable research interest and have seen rapid growth due to the remarkable progress in microelectronics and electromechanical systems. Recent advances in wireless communications and electronics have enabled the development of low-cost, low-power and multi-functional sensors that are small in size and communicate in short distances. Cheap, smart sensors, networked through wireless links and deployed in large numbers, provide unprecedented opportunities for monitoring and controlling homes, cities, and the environment. In addition, networked sensors have a broad spectrum of applications in the defense area, generating new capabilities for reconnaissance and surveillance as well as other tactical applications [1,2]. Also, WSNs are comprised of numerous wireless sensor nodes that can sense light, temperature, sound, motion, etc. and wirelessly transmit them to a remote base station that aggregates the data and processes it locally or at another location.

In some applications, real-time, deadline violations that can occur in processing or transmission of collected data may result in some catastrophic events. Due to the necessity of time lines of computing in some of WSN applications, many valuable researches on real-time communications, power management and task scheduling have been done. Depending on the application, there may be a need to rapidly respond to sensor input. For instance, in a fire handling application, actions should be initiated on the event area as soon as possible. Moreover, the collected and delivered sensor data must still be valid at the time of action. Thus the issue of real-time communication is very important in WSN. Although several real time protocols have been proposed for mobile ad-hoc networks; due to differences between ad-hoc networks and WSN, it is not suitable to directly transplant those protocols into the design of WSN. In the large-scale sensor networks data integrity and reliability in addition

to real-time communication is also an issue. The reliability of data is crucial to take an effective decision.

One important application is the traffic control and management system (TCMS) that is based on a wireless sensor network [12 – 16]. It gathers the traffic information and controls the traffic flow according to the incoming traffic data. Many traffic light systems operate on a timing mechanism, preset cycle time that changes the lights after a given interval. An intelligent traffic light system senses the presence or absence of vehicles then it controls the traffic lights accordingly. The idea behind intelligent traffic systems is that drivers will not spend unnecessary time waiting for the traffic lights to change which may lead them to some traffic violations and accidents when some drivers start to lose their patience.

An intelligent traffic system detects traffic in many different ways. The older system uses weight as a trigger mechanism. Current traffic systems react to motion to trigger the light changes based on the infrared object detector that picks up the presence of a car or some proximity switches. Then, a switch causes the lights to change. In order to accomplish this, algorithms are used to govern the actions of the traffic system. We need to understand the function of traffic signals so that we can improve driving habits by controlling the speed and the red light crossing in order to reduce the number of associated traffic accidents. The more the drivers know about the operation of traffic signals, the less frustrated they are going to be while waiting for the lights to change. Usually, in the intelligent traffic signal systems, the main aim is to reduce the cars waiting time at each signal and also to maximize the total number of cars that can cross an intersection safely with the green signal time.

In this chapter, the main goal is to gather the information of incoming vehicles via WSN for the decentralized deployed smart traffic light signals controllers along a the highway as shown in the Figure.1, that can do the following while maintaining fairness among the other traffic lights:

1. Intelligent traffic management system based on the queue length of cars in each signal side.
2. Optimize the following (trade-off):
 - a. Minimize Average waiting time.
 - b. Maximum possible service time (Green Duration).
 - c. Minimize overall delay to vehicles.
 - d. Maximize network capacity.
 - e. Minimize the average number of cars of the same queue not passing from the same green duration.
 - f. Minimize accident potential for all users.
3. Synchronizing the traffic lights phases that are placed in same directions along the highway to minimize the car stoppage, stop & start behaviour that build up queues and reduce the waiting time especially if the traffic in other sides is lower. For example, the intersections (A,B,C) we will maintain for the directions that cross all of them the green signal in a synchronized manner such that the queue length will be minimized and total travel time is minimum. We will apply the decentralized control approaches to handle that and the data collection will be the WSN.
4. Handling of the red light crossing violation to minimize the number of accidents by giving and alarm to the car which is about to start moving from the green light side.

5. The system can also give indication to the police traffic control room in case the road is blocked due heavy traffic to take an immediate action.

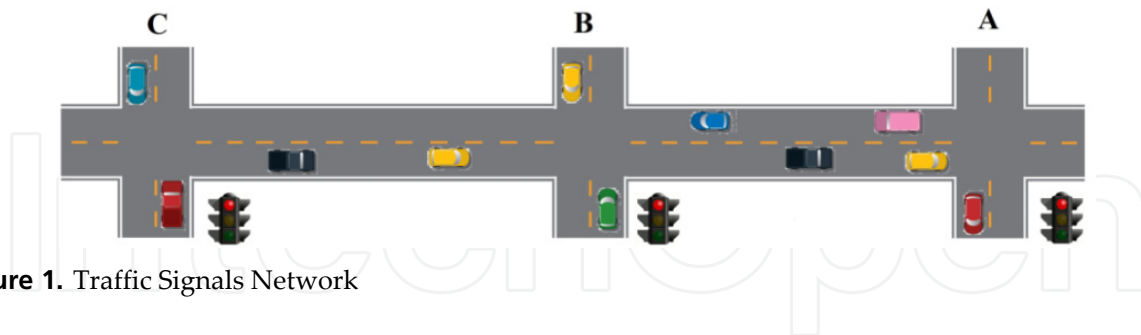

Figure 1. Traffic Signals Network

It is important to note that some of the objectives do conflict and a compromise may have to be made in the selection of objectives. However, some objectives can be met in tandem, for example minimizing delay to vehicles would also help to minimize total travel time and increase network throughput.

In planning and designing a traffic signal control system, one must first understand the applicable operational concepts related to signalized intersection control and signal-related special control. Signalized intersection control concepts include:

- Isolated intersection control - controls traffic without considering adjacent signalized intersections.
- Interchange and closely spaced intersection control - provides progressive traffic flow through two closely spaced intersections, such as interchanges. Control is typically done with a single traffic controller.
- Arterial intersection control (open network) - provides progressive traffic flow along the arterial. This is accomplished by coordination of the traffic signals.
- Closed network control - coordinates a group of adjacent signalized intersections.
- Areawide system control - treats all or a major portion of signals in a city (or metropolitan area) as a total system. Isolated, open- or closed-network concepts may control individual signals within this area.

Signal-related special control concepts include:

- High occupancy vehicle (HOV) priority systems.
- Preemption - Signal preemption for emergency vehicles, railroads, and drawbridges.
- Priority Systems - Traffic signal control strategies that assign priority for the movement of transit vehicles.
- Directional controls - Special controls designed to permit unbalanced lane flow on surface streets and changeable lane controls.
- Television monitoring.
- Over height vehicle control systems.

2. Problem statement and formulation

Controlling the traffic light intersection requires a prior knowledge of that intersection and the traffic load to be able set the proper parameters for the control algorithm, especially if

the system used is not an intelligent system like time based traffic control. Basically most of the traffic signals [18] intersections have four directions queues, North (N), South (S), East (E) and West (W) (see Figure 2.). The other queues possibilities are North West (NW), South East (SE), East South (ES) and West North (WN) (see Figure 3). The model in Fig.3 simply shows that two directions can be open at the same time, for example, N and S direction will move then W and E at the same time because there is no turning in other directions like NW or SE. The other scenario is when we have the other directions NW; SE; ES and WN, then the control algorithm will be more complicated and more sensing elements are required. So, the main goal is to provide a controlling mechanism to minimize the waiting time for vehicles waiting in the red signal and maximize the service time for cars passing the green signal to avoid if possible the number of cars not able to pass from the first time or at least minimize this number. For simplicity, we will give a number for each queue q_i where $i = 1, \dots, 8$ for the following in order (N, S, E, W, NW, SE, ES, WN).



Figure 2. Basic Intersection

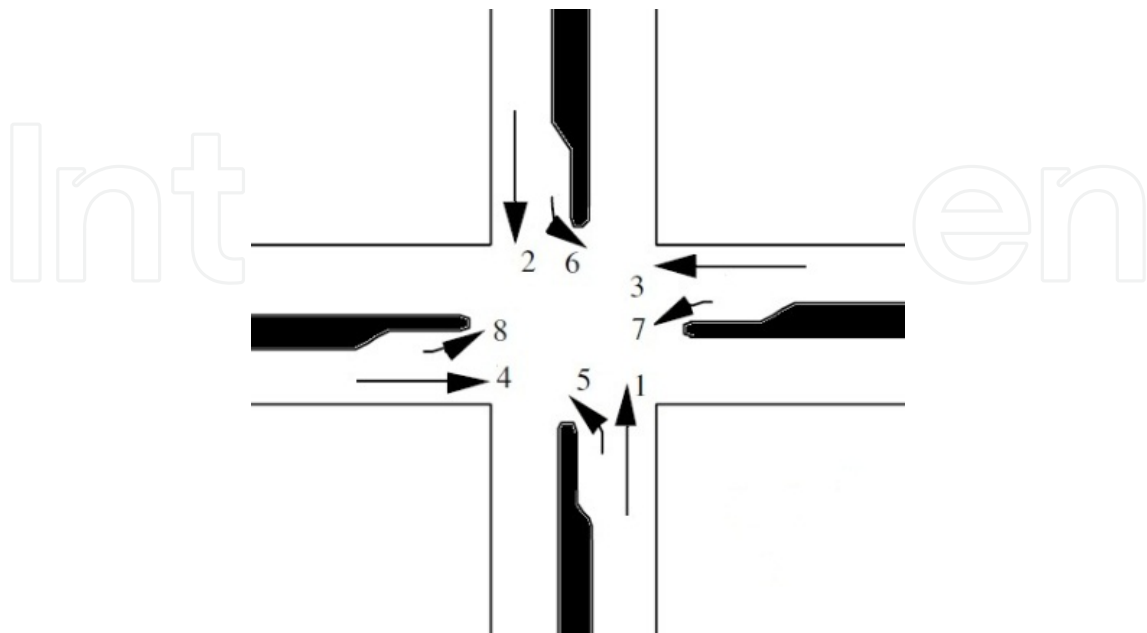

Figure 3. The Typical Intersection Directions

The intersection consists of four streets with 8 possible queues; assuming all right side movements are free and do not require a signal. The state equation for the continuous traffic flow process associated with any movement i that is sampled every t seconds, where time is indexed with the integer k , can be expressed by the current queue $q_i(k)$:

$$q_i(k+1) = q_i(k) + q_i^{in}(k) - q_i^{out}(k) + \phi_i^{in}(k) - \phi_i^{out}(k), \quad i = 1, 2, \dots, 8 \quad (1)$$

where $q_i^{in}(k)$ is the incoming new vehicles at time interval $[k-1, k]$ in link or queue i , $q_i^{out}(k)$ is the number of vehicles were able to pass the intersection during the green signal interval T_g from link or queue i , also T_g can be called as the control interval, $q_i(k+1)$ is the queue of vehicles were waiting for green signal to happen at time k , $\phi_i(k)$ represents the fluctuation between a parking lot and link i or the effects of any non-controlled intersection between any two intersections where $\phi_i^{in}(k)$ used for vehicles left the parking or came from non-controlled intersection and joined the traffic in the queue i and $\phi_i^{out}(k)$ for vehicles left the queue i and went for a parking or went into a sub road or what we call it non-controlled intersection. These disturbing flows can be considered either as disturbance or as known perturbations if they can be well measured or estimated. In case of these uncertainties or perturbations are unknown and can't be measured, then robust control system is needed.

The general discrete LTI state space representation is the following:

$$x(k+1) = A x(k) + B u(k) + F d(k) \quad (2)$$

$$y(k) = C x(k)$$

The state matrix A is practically considered as an identity matrix. The elements of the state vector $x(k)$ represent the number of vehicles of each controlled link or in another word the queue length in that lane and the number of states is equal to the number of controlled links in the network. The second term of the state equation is the product of input matrix B and control input u where the vector u contains the green times of all stages. Matrix B can be constructed by the appropriate allocation of the combinations of saturation and turning rates. Their numerical values are the results of a corresponding controller at each cycle. The diagonal values of B are negative and represents the saturation flow and the product of $B_{ij} u_i$ where $i = j$; diagonal elements shows the outflow from link i . The other elements in B_{ij} where $i \neq j$ contains the turning rates from link i to link j . Naturally the number of states is equal to the number of controlled links in the network. The product $B u(k)$ is arising from difference of in and out flow for the traffic in the link or queue i during the control interval. Each output inside of the network is a measured state (number of vehicles of the link i that makes the output equation simplified to, $y(k) = x(k)$ and $C = I$. Finally, the traffic coming from non-controlled intersections or parking are considered as disturbance to the system in $d(k)$.

Flow characteristics of traffic are fundamental in analyzing intersection delay or capacity. Vehicles occupy space and, for safety, require space between them. With vehicles moving continuously in a single lane, the number of vehicles passing a given point over time will depend on the average headway or the average arrival rate per unit time.

Two factors influence capacity at a signalized intersection:

- Conflicts occur when two vehicles attempt to occupy the same space at the same time. This requires allocation of right-of-way to one line of vehicles while the other line waits.
- The interruption of flow for the assignment of right-of-way introduces additional delay. Vehicles slow down to stop and are also delayed when again permitted to proceed.

These factors (interruption of flow, stopping, and starting delay) reduce capacity and increase delay at a signalized intersection as compared to free-flow operations. Vehicles that arrive during a red interval must stop and wait for a green indication and then start and proceed through the intersection. The delay as vehicles start moving is followed by a period of relatively constant flow. The Figure.4 illustrates the relation between the traffic flow and density (Fundamental diagram of traffic flow) and what can happen if the flow reaches the maximum and exceeds the critical density point which at the end leads to the jam density point where no vehicle will move.

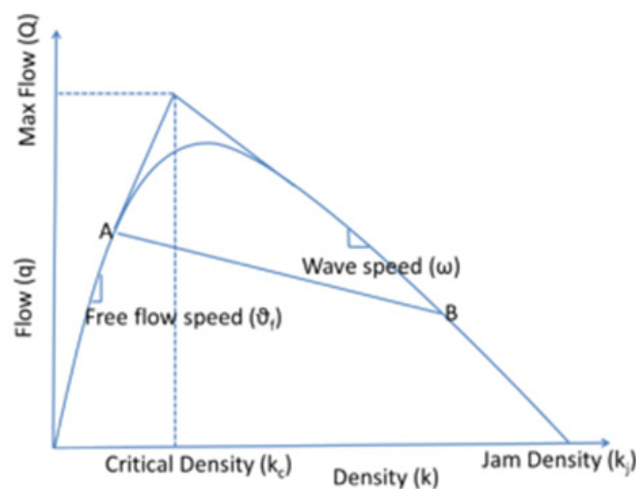

Figure 4. Traffic Flow Density Relation

Similar to the flow-density relationship, speed will be maximum, referred to as the free flow speed, and when the density is maximum, the speed will be zero. The simplest assumption is that this variation of speed with density is linear as shown by the solid line in Figure 5. Corresponding to the zero density, vehicles will be flowing with their desire speed, or free flow speed. When the density is jam density, the speed of the vehicles becomes zero. It is also possible to have non-linear relationships as shown by the dotted lines [9].

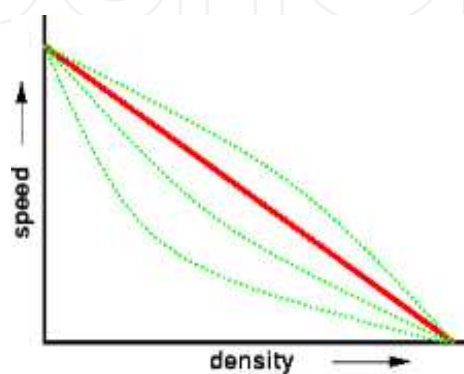

Figure 5. Speed-density diagram

The 3rd relationship is between the speed and flow where the flow is zero either because there are no vehicles or there are too many vehicles so that they cannot move. At maximum flow, the speed will be in between zero and free flow speed. This relationship is shown in Figure 6. The maximum flow Q_{max} occurs at speed certain speed which is the changing point in the parabola. Also, it is possible to have two different speeds for a given flow [10].

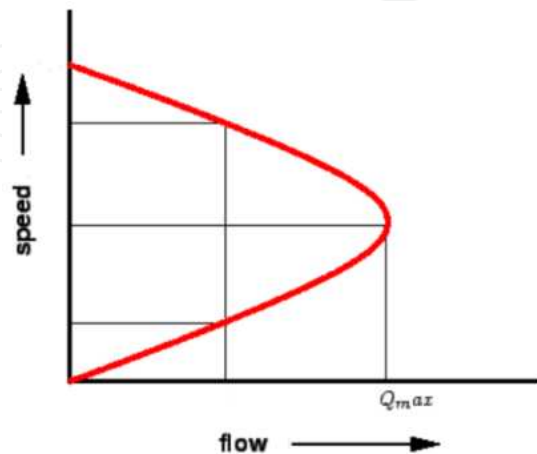

Figure 6. Speed and Flow

The diagrams shown in the relationship between speed-flow, speed-density, and flow-density are called the fundamental diagrams of traffic flow. They can be combined as shown in Figure 7.

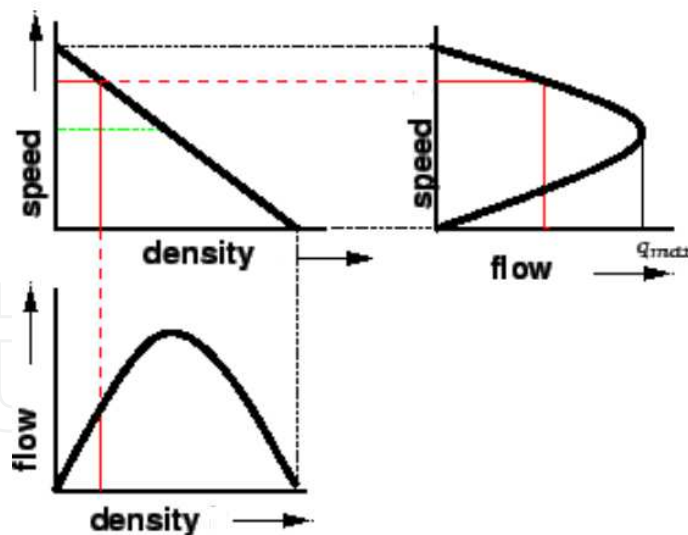

Figure 7. All Traffic Fundamental Relations

In case of detectors are not used, the simplest approach to model vehicle arrivals is to assume a uniform arrival. This will results in a deterministic, uniform arrival pattern which means constant time headway between all vehicles. However, this assumption is usually unrealistic, as vehicle arrivals typically follow a random process. Thus, a model that represents a random arrival process is needed and the most suitable one is the Poisson

distribution with arrival rate of λ . In general, the car arrival is part of the queuing model (e.g. M/M/1 or M/G/1) which simulates the traffic signal operations. Basically the queue model is any service station with the following:

- One or multiple servers
- A waiting area or buffer

The time τ_n is interarrival time between cars n and $n+1$ and it is a random variable. The traffic light system is following the stochastic process behaviour.

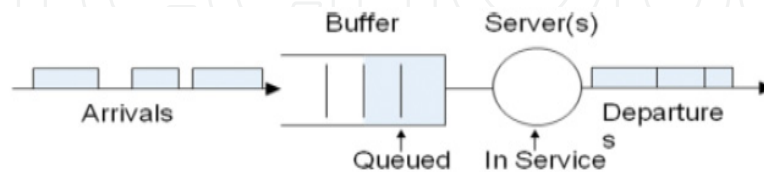

Figure 8. Basic Queue System

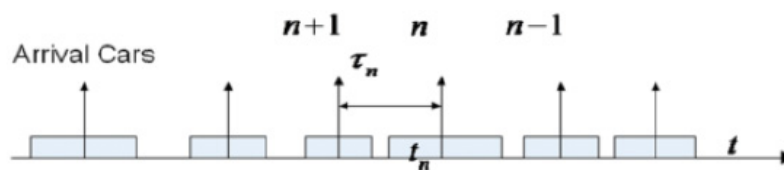

Figure 9. Arrivals Cars in time

3. Traffic signal phasing

The green signal period given for each side or combination of directions will be called phase (Figure.7) and the time will be T_g . The combination of phases can be called as Cycle where each phase or cycle must not exceed certain period to maintain the fairness for all direction in that intersection and it shall not be less than certain minimum. In all situations, the phases time shall not push the situation in that intersection to exceed the saturation level which will lead to traffic jam as we can see from Figure.4.

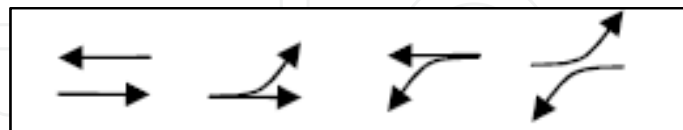

Figure 10. Different Phases for Traffic Signal Intersection (Examples)

Phasing reduces conflicts between traffic movements at signalized intersections. A phase may involve:

- One or more vehicular movements.
- One or more pedestrian crossing movements.
- A combination of vehicular and pedestrian movements.

The National Electrical Manufacturers Association (NEMA) has adopted and published precise nomenclature for defining the various signal phases to eliminate misunderstanding

between manufacturers and purchasers [3]. Figure 5 illustrates a 4-phase sequence separating all vehicular conflicts. Holding the number of phases to a minimum generally improves operations. As the number of phases increases, cycle lengths and delays generally increase to provide sufficient green time to each phase. The goals of improving safety (by adding left-turn phases) and operations at a signalized intersection may conflict, particularly with pre-timed control. Operational efficiency at a signalized intersection, whether isolated or coordinated, depends largely on signal phasing versatility. Variable-sequence phasing or skip-phase capability proves particularly important to multiphase intersections where the number of change intervals and start-up delay associated with each phase can reduce efficiency considerably. Each set of stored timing plans has a distinct phase sequence.

Full-actuated traffic control illustrates variable-sequence phasing. In Figure 3, all approach lanes have detectors, using these detectors; actuated control skips phases with no traffic present and terminates certain movements when their traffic moves into the intersection. This capability produces a variation in the phasing sequence. The phasing options selected may be changed with the signal timing plan.

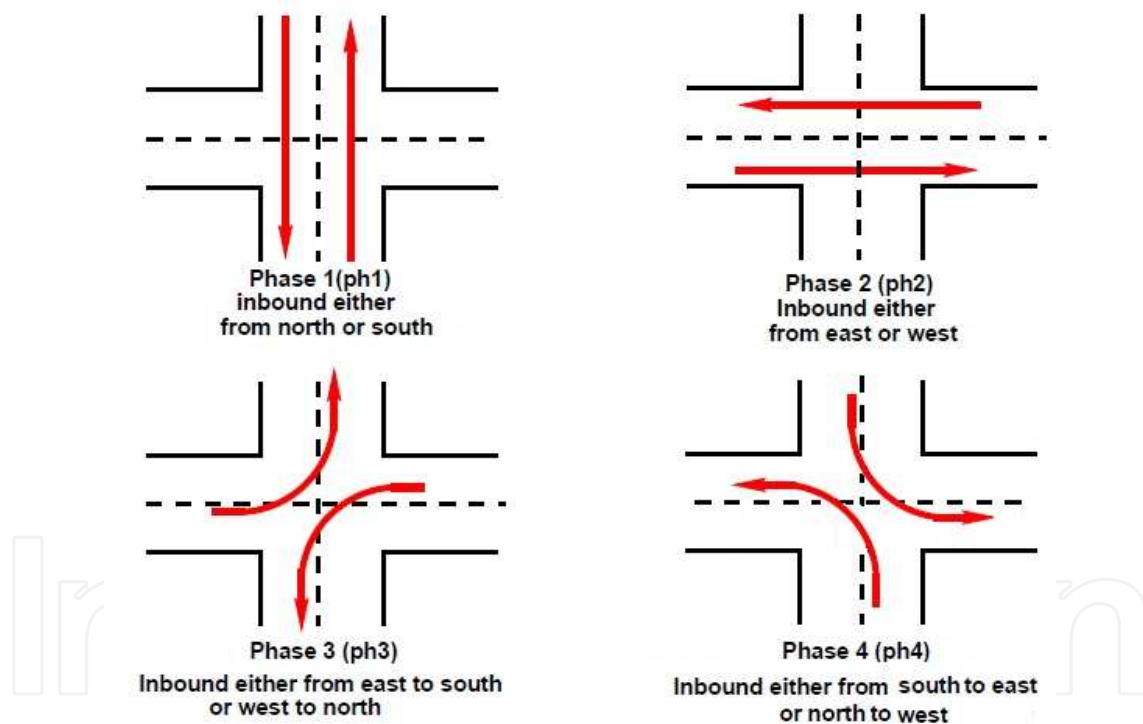

Figure 11. Example of Four Phases Intersection

4. Traffic detection at signalized intersection

Vehicle detectors (or in another word "Sensors") at a signalized intersection serve the singular purpose of informing the controller that a vehicle is (or is not) present on a particular approach to an intersection at any point in time. The controller uses this information to regulate the assignment of green time among competing movements at the intersection. The detector configuration is specified in terms of type, shape, length and setback from the stop line. These

four parameters are all related to the physical installation of the detectors themselves. At signalized intersections with multilane approaches and actuated control, vehicle detectors are usually placed in each individual lane. Currently, the detectors across all lanes on a particular approach are linked together and are channeled to the same signal phase for controlling the phase duration. When any of the detectors detects a vehicle, the controller's gap-out timer resets and the phase (green) extends. Such a detection scheme makes it difficult to gap out a phase based on the desired headway or gap, especially when an approach has more than one lane. The unnecessary green extension directly affects the efficiency of signal operations, in which the extra green could be allocated to better serve other traffic movements. Ideally, a signal phase should terminate when a gap-out is reached for each lane individually [5]. The selection of the type of detector in signalized intersections is determined primarily by suitability for the intended purpose. The decision whether a particular detector is appropriate for a certain purpose depends on its operating characteristics, the cost, its adaptability to the particular application, and the location specific details of the installation requirements. Generally, vehicle detectors at signalized intersections are designed to sense either the presence of a waiting vehicle or the passage of a through vehicle.

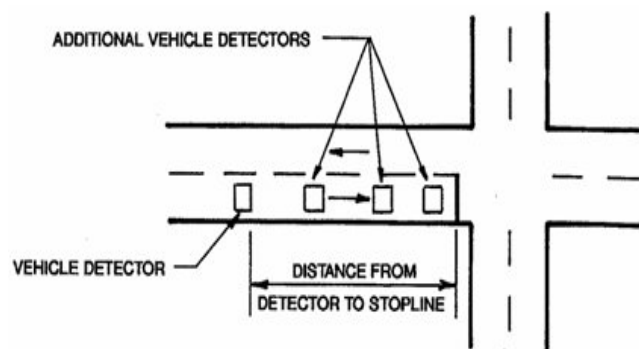

Figure 12. Multi Detectors Design

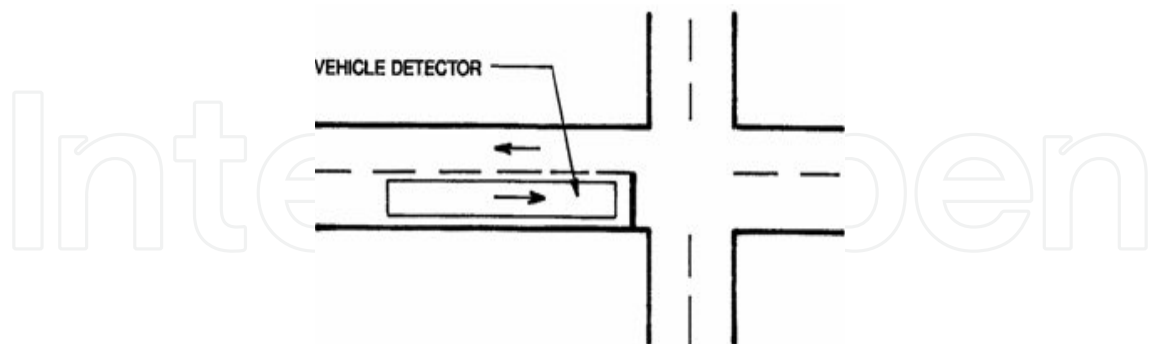

Figure 13. Long Presence Detector Design

Several types of detectors can be used and a wireless version for each type is possible for the data transfer. The following list shows these types in brief:

- **Inductive loop detectors (ILDs)** are the most commonly used type [5,6] of vehicle detection because of their reliability in reporting vehicle presence. However, loop detector installation can be expensive because of the physical connection required to

connect the loops back to the traffic cabinet. Such connections are sometimes infeasible at locations such as bridges and ramps. Furthermore, saw-cut inductive loops are particularly sensitive to moisture and wire breaks associated with pavement failure.

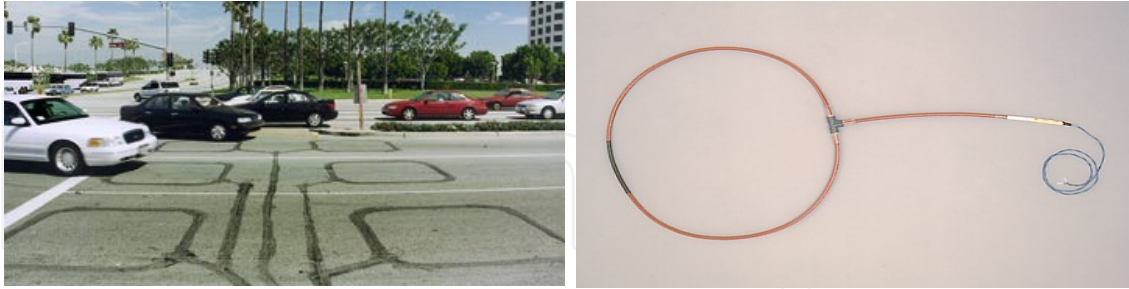

Figure 14. Inductive loop detectors (ILDs)

- **Compact wireless magnetometers** are a promising alternative to loops [5,6] because they require substantially less pavement cutting and no physical connection to a monitoring device.

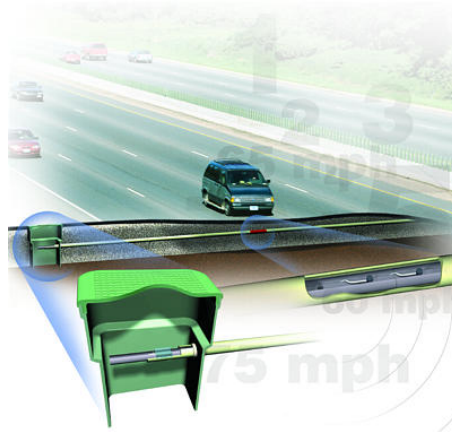

Figure 15. Compact wireless magnetometers

- **Video Imaging Vehicle Detection Systems (VIVDS)** have overcome some of the problems with loops such as traffic disruption and pavement degradation; but they have not been as accurate in all weather and light conditions as originally anticipated [7].



Figure 16. Video Imaging Vehicle Detection Systems (VIVDS)

- **Digital Wave Radar Detectors** technology to measure presence and speed of approaching vehicles in certain distance range based on the sensor features. It is well tested and very efficient.

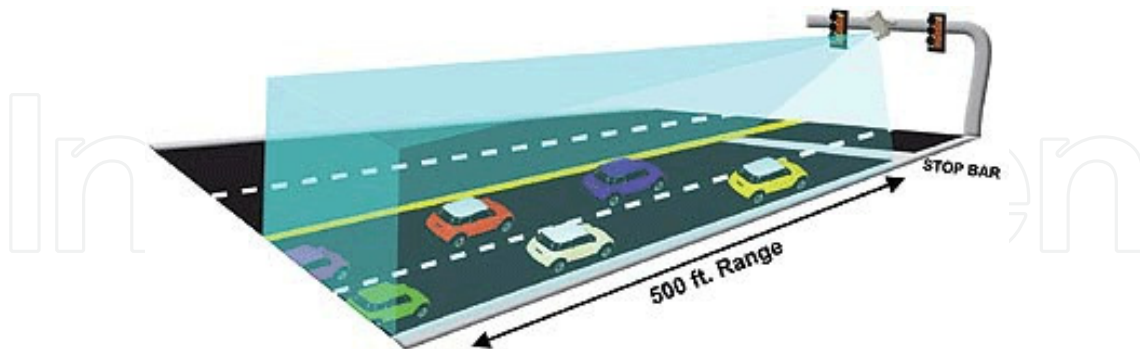

Figure 17. Digital Wave Radar Detectors

- **IR detectors:** Infrared sensors are often used to detect stopped vehicles and also to detect pedestrians at pedestrian crossings.

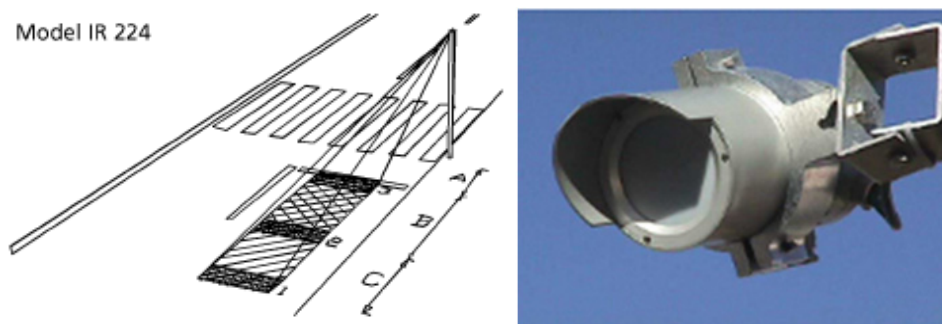

Figure 18. IR detectors

- **Ultrasonic Detectors:** transmit sound at 25 KHz to 50 KHz (depending on the manufacturer). These frequencies lie above the audible region. A portion of the transmitted energy is reflected from the road or vehicle surface into the receiver portion of the instrument and is processed to give vehicle passage and presence. A typical ultrasonic presence detector transmits ultrasonic energy in the form of pulses.
- **Passive Acoustic Detectors:** Vehicular traffic produces acoustic energy or audible sound from a variety of sources within the vehicle and from the interaction of the vehicle's tires with the road surface. Arrays of acoustic microphones are used to pick-up these sounds from a focused area within a lane on a roadway. When a vehicle passes through the detection zone, the signal-processing algorithm detects an increase in sound energy and a vehicle presence signal is generated. When the vehicle leaves the detection zone, the sound energy decreases below the detection threshold and the vehicle presence signal is terminated.
- **Combined technologies:** Above ground detectors using several different detector technologies are especially useful on highways or in tunnels to provide a wide variety of accurate detection parameters and classification information from a single location.

Also, the classification of detectors can be based on the function [8] of these detectors and the physical location that it will be placed on. Based on the functions of vehicle detection at signalized intersections, the main types of vehicle detections at signalized intersections are listed as follows:

1. **Advanced detection:** they are located in advance of the stop line. They are only used to detect moving vehicles. The common function of advance detection is to provide dilemma zone protection on high-speed approaches to signalized intersections. The dilemma zone is an area on the approach to a traffic signal whereby there are varied responses by drivers to the onset of the yellow signal. There is a different length dilemma zone for each approach speed. Also, these can be used for counting the arrival cars and send the information to intersection controller prior to arrival to signal for better selection of phase and green timing.
2. **Stop line detection:** are the most common and are so named because they are located at the stop line. Stop line detectors require greater sensitivity as slow moving or stopped vehicles must be detected. The location of the loop in relation to the stop line must be such as to ensure that a vehicle's normal stopping position is in the detection zone. In addition the detector must have sufficient memory time to monitor waiting traffic even under conditions of extreme congestion.
3. **Left & Right turn detection:** these will detect the cars going for the right side.
4. **Counting detection:** These traffic counting detectors can be used to count traffic in individual lines, lanes in a particular direction simultaneously, or all lanes in both directions continuously. As the number of lanes counted by a single detector increases, the accuracy of the count decreases as multiple vehicles can occupy the same detector at the same time.
5. **Violation detection:** Violation detectors are installed in conjunction with a red signal violation camera and flash unit to enable red signal traffic violations to be detected. If a vehicle passes over one of the detectors while facing a red signal the camera and flash are activated.
6. **Truck Detection:** The truck detector would be an added detector and would be placed much farther from the intersection. Its purpose would be to grant a green extension that would carry the truck to the normal detector location where it would also get an additional green extension. Therefore, if the "last vehicle" arriving at an intersection during the green interval is a truck, it will get dilemma zone protection as well as a green extension. If the last vehicle over the normal detector is a car, but there is a truck following that has actuated the truck detector, the truck will have sufficient green time to also reach the intersection. These detectors should have the ability to detect the specific vehicles such as trucks or buses with a high accuracy.

The improper placement of detectors can increase the lost time per phase and therefore the total lost time per signal cycle. This lost effective green time leads to an increased individual and total delay for vehicles using the intersection. For a signal installation which is operating near capacity (i.e. with $0.85 < v/c < 0.95$) it is highly likely that the green time on a particular phase will be terminated by a vehicle interval extension gapping out rather than

by the green time maxing out. Studies have shown that at efficiently designed intersections, that is intersections operating near capacity where the mean service rate is greater than the mean arrival rate, the signal timings can be set such that 90% of the signal terminations will involve a gap out and only 10% of the signal terminations will involve a max out (a max out corresponds to a cycle failure). Maxing out of the signal phase, and hence a cycle failure, will be caused by random fluctuations in the arrival rate and can be predicted by employing a stochastic delay model.

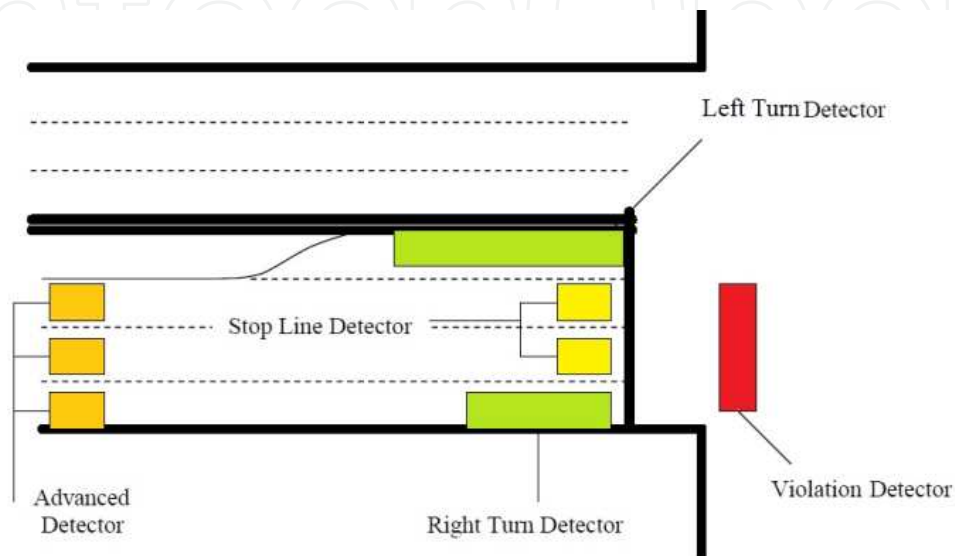

Figure 19. General Layout of Vehicle Detectors at Signalized Intersection

5. Signal control strategies

From the traffic engineering point of view, several different strategies are employed for the control of traffic signals ranging from non-actuated fixed timed to fully traffic responsive volume-density control. Fixed time, also known as pre-timed, controllers are of limited use for isolated intersections and require no traffic detection. Traffic actuated controllers are by far the most common control method used for isolated intersections. These traffic actuated controllers can range from semi-actuated, to fully traffic actuated, to traffic responsive volume-density. All traffic actuated controllers require vehicle detection on all legs of the intersection for efficient operation.

The general operation of traffic actuated controllers is described as follows:

- The green time for each phase is determined by the volume of traffic on the corresponding street and may vary from cycle to cycle. A maximum green time is predetermined and set within the controller.
- The request for green time is placed by a vehicle detector actuation during the red phase of a conflicting traffic movement. The minimum initial green time available is predetermined and set within the controller. This minimum initial green time is usually set to be adequate for the number of vehicles waiting between the stop line and the vehicle detector.

- Each additional vehicle which actuates the detector during the green phase calls for a vehicle green interval extension of a predetermined length. This extends the minimum green time up to the maximum green time set in the controller. Figure 20. Illustrates the vehicle interval extension process. If a gap in between vehicles occurs which is larger than this preset vehicle interval extension, and a call has been placed by an opposing phase, then the controller will 'gap out' and the green will be terminated for that phase. If enough traffic is present for the controller to reach the maximum green time then the controller will 'max out' and the green time will be terminated.

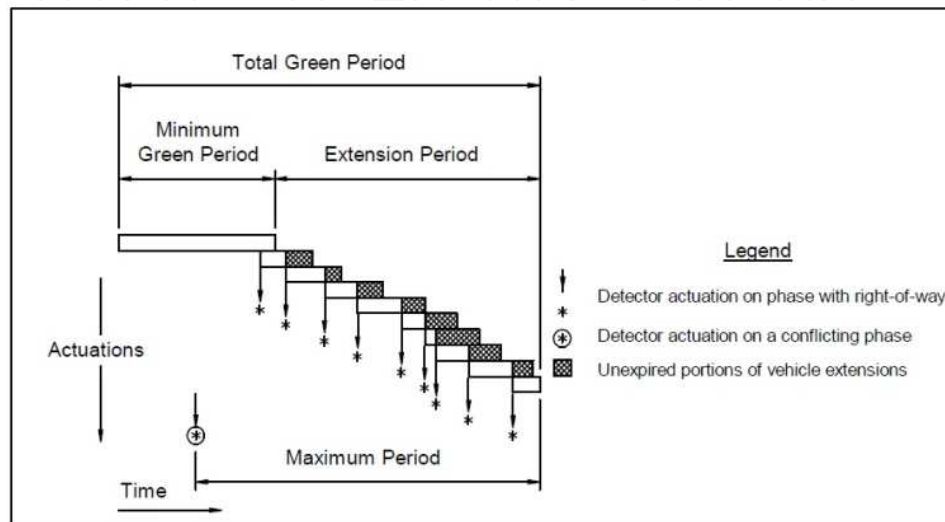

Figure 20. Actuated Controller Intervals

Some variations in the operation specific types of traffic actuated controllers is described as follows:

5.1. Semi-actuated controllers

- Semi-actuated controllers are used at intersections where the minor street has traffic volumes significantly lower than the major street. The priority of operation is to minimize the interruption of traffic on the major street while still providing adequate service to the minor street.
- Vehicle detectors are required only on the minor street. The detectors will input a call for green time as well as calls for vehicle interval extensions up to a preset maximum limit.
- The major street has a preset recall to its green phase. No detector call is required and the green will always revert to major phase when the minor street has been serviced. The major street will have a preset minimum green time, and will continue to rest in green on that phase until a call has been placed by the minor street.

5.2. Fully-actuated controllers

- Fully-actuated controllers are used where both streets at an intersection have relatively equal volumes. These controllers are particularly efficient where the traffic flows are

sporadic and uneven. The priority of operation is to minimize the total delay by minimizing stops on all phases.

- Vehicle detectors are required on all legs of the intersection. These detectors will input calls for initial minimum green time as well as vehicle interval extensions.
- Any or all phases of the signal can be set for automatic recall to green which will give the corresponding phase the minimum green time without a vehicle actuation. If all phases have automatic recall set then the signal will cycle through all the phases, giving each phase a minimum green time, even if no traffic is present on a particular leg. If recall is not set on any phase then the signal will service only those phases that have traffic actuations and skip the others. In the absence of any traffic, such as nighttime operation, the controller can either rest on the last served green phase or rest on red on all phases. If recall is set on only one phase the signal will revert to green on that phase once during every cycle. In the absence of traffic the signal will rest on green on this phase. This is a common setting for many intersections as one of the legs is usually considered slightly more major than the others.

5.3. Volume-density controllers

- Volume-density controllers are similar in operation to fully actuated controllers; however, contain more advance features for analyzing the traffic volumes on the green phase being served and the traffic density on the red phase being held. This information is then processed and the timing patterns altered for a more efficient operation. These controllers are the most efficient means of operation signals at isolated intersections.
- The most important feature of volume-density controllers is the ability to reduce the green vehicle extension interval depending on the density of opposing traffic. As the measured density of the opposing traffic increases the vehicle extension interval for green time is reduced linearly (known as gap reduction) to some preset minimum extension time.
- The controller has the ability to increase the minimum green time depending on the number of vehicles queued behind the stop line.
- In order to function properly these controllers must obtain information early enough to react to the fluctuating traffic patterns. Detectors must be place well in advance of the stop lines for such information to be useful.
- A special version of the volume-density controller, known as a 'Modified-Density Controller', has many of its features but requires less information from the intersection. Traffic flow statistics are obtained from the detector actuations of the previous cycle with the assumption that the present cycle being served has the same characteristics as the cycle preceding it. This may be acceptable for situation where traffic flow is relatively deterministic, however, is not efficient where intersection have highly unpredictable and random flows.

5.4. Fixed-time controllers

- Also we call it Pre-timed, in which we program fix phases sequence & timing based on data collected for peak hours for certain time. It may do a good job for less crowd

intersections and also lower cost but it has the major disadvantage of being unable to adapt to changing conditions in real-time. At best they can be manually updated using accumulated traffic data however this is a time-consuming exercise and could not be carried out to allow for unpredictable incidents e.g. accidents or breakdowns. For these reasons, an adaptive control system is preferable [12].

5.5. Decentralized traffic signal control

As we have stated in the previous section the different signal control strategy from traffic engineering side, we will discuss now the traffic signal control based on the control engineering concepts. All mentioned types above are for isolated intersections, which means that there is no information exchanged between intersections and this structure or type of control we call it Decentralized Traffic Control. So, all of the previous mentioned control strategies' are belong to this type of control structure and the difference is the number of inputs based on the detectors quantity and functions.

Decentralized control [20-28] divides the overall system into S subsystems, and controls the subsystems separately based only on the local model and the information of the corresponding subsystem [11]. By dividing the original system into subsystems and by designing decentralized controllers, the full information of the whole system is also separated into parts. The information interactions between subsystems are cut off and incoming traffic from other intersections are considered constants or estimated, which results in fully isolated systems.

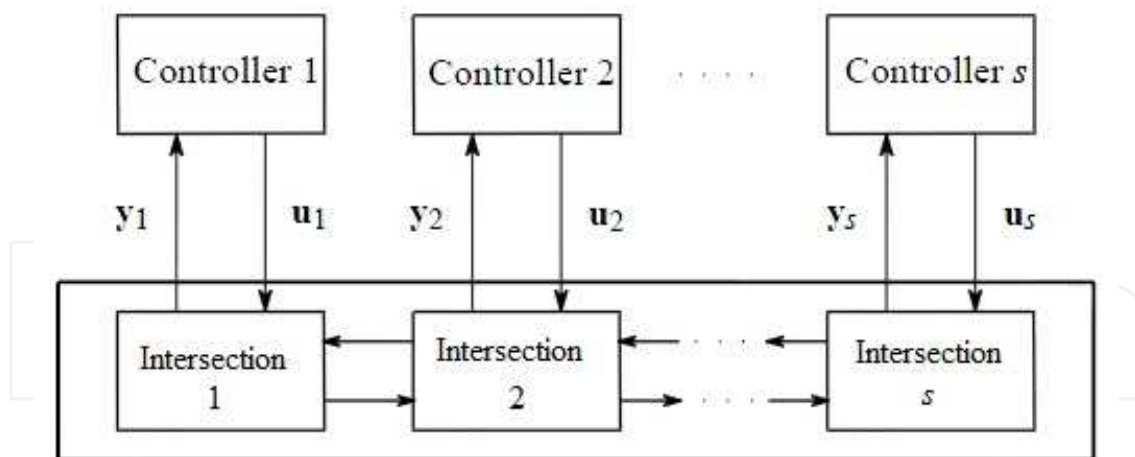

Figure 21. Decentralized Control Structure

Because the estimates of the input traffic flows from other subnetworks may be far from the real values, the local controllers may not be able to find the real optimal solutions for the subnetworks. Moreover, since the subnetworks are completely disconnected, the overall performance of the whole network will be deteriorated. As mentioned, that this type of control will do well for the isolated intersections but consider the case of an arterial network that we want to let the flow move smoothly from one intersection to the next without

stoppage or minimum stoppage which of course will minimize the delay and avoid stop/start behaviour of vehicles that lead to queue accumulation.

This opens another issue which we call it **Traffic signal coordination** that is normally implemented to improve the level of service of a road or a network of roads, where the spacing of signals is such that isolated signal operation would cause excessive delays, stops and loss of capacity. The popular concept is that coordinating traffic signals is simply to provide green-wave progression whereby a motorist travelling along a road receives successive green signals. While this is one of the aims, the principal purpose of coordination is to minimize overall delay and/or number of stops. This can be achieved using fixed-timing plans or using adaptive technology.

The three main components of coordinated timings are:

- Cycle time the time to complete all phases in a timing plan (a phase is any period in a cycle where non-conflicting traffic movements may run).
- Stage splits - the amount of time allocated to a phase in a cycle
- Offsets - green signals at adjacent intersections are set to occur at a given time, relative to that at a reference intersection. It depends on the distance between signals, the progression speed along the road between the signals and the queues of vehicles waiting at red signals.

In Figure.22 the left part, you can see that the vehicle is delayed at the second intersection due to an uncoordinated signal time offset while in the right figure the vehicle is not delayed at the second intersection due to a coordinated signal time offset

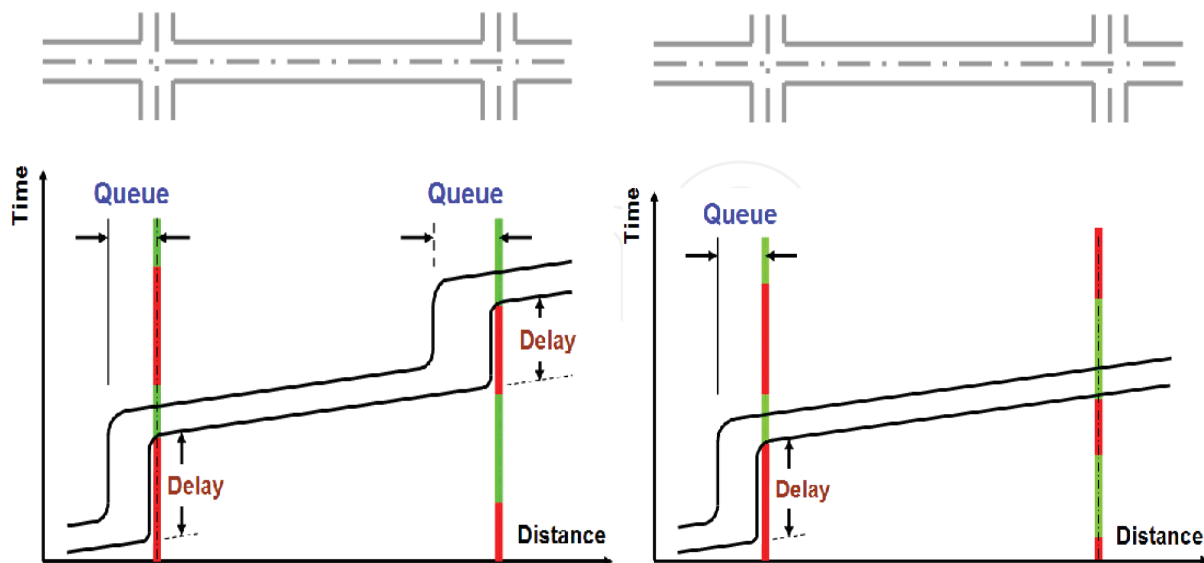

Figure 22. Two Traffic Intersection, the Left figure is without Coordination, the right figure is with coordination

Without coordination, there are frequent stops and unnecessary delays, for example:

- Vehicles pass through a green light at one intersection only to be stopped by a red light at the next intersection, causing inconsistent travel;
- Vehicles must wait through more than one green signal at an intersection due to blockages ahead;
- Vehicles must stop at a red light when there are no other vehicles or pedestrians at the cross street.
- In addition to extending travel time these situations also increase fuel consumption and emissions, as a stationary vehicle is much less efficient than a vehicle in motion.

The type and the amount of coordinated information will introduce the terms **Quasi Decentralized & Distributed Control structures**. In the Quasi Decentralized we allow minimum necessary amount of information for the purpose of coordination between intersections. For example, the current executed phase in the progressive intersection signal can be sent to the successive intersection to allow the scenario shown in Figure 22, the right part, and hence it very important to have good sensors and communication network. The distributed structure will allow more data transfer and also will required more sensors and detectors. This can be grateful from the first impression but it may add also an overhead communication which may delay the control signal or perform the control command before the arrival of the information.

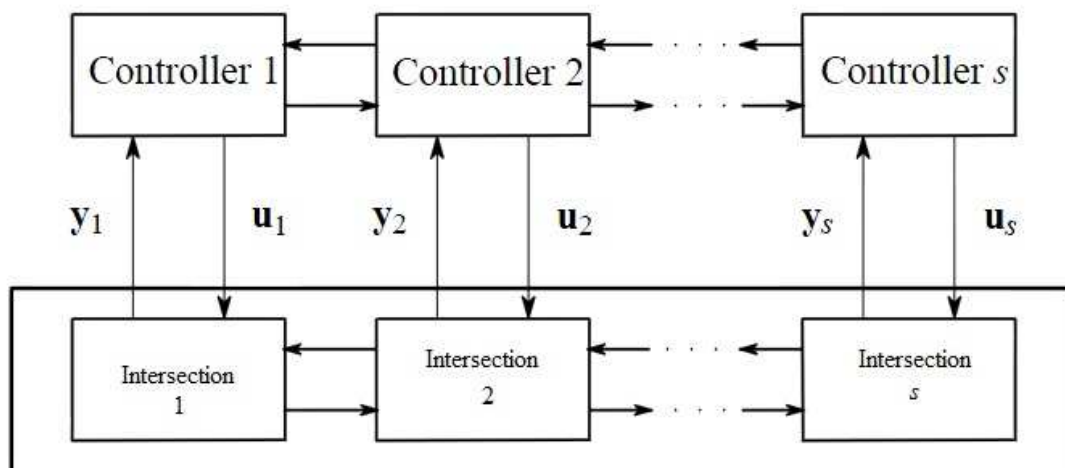

Figure 23. Distributed Control Structure

One more way is divide the large urban network into sub areas and assign controllers for each intersection, and another master or coordinator controller for that area to coordinate between local controllers. This is what we call the Hierarchical Control structure where the controllers mainly aiming at solving specified different tasks locally while the upper-level controllers will coordinate (or supervise) the subsystems from a global point of view or global objective function.

Since we are talking about the sensors network we should highlight the network link impacts on the sensors function that caused by the environment conditions or from the link

itself such as the packets delay, dropout and sampling time selection. In each case there several methods to handle it and what are the controller actions in such scenarios to continue the operations of traffic signals smoothly as much as possible.

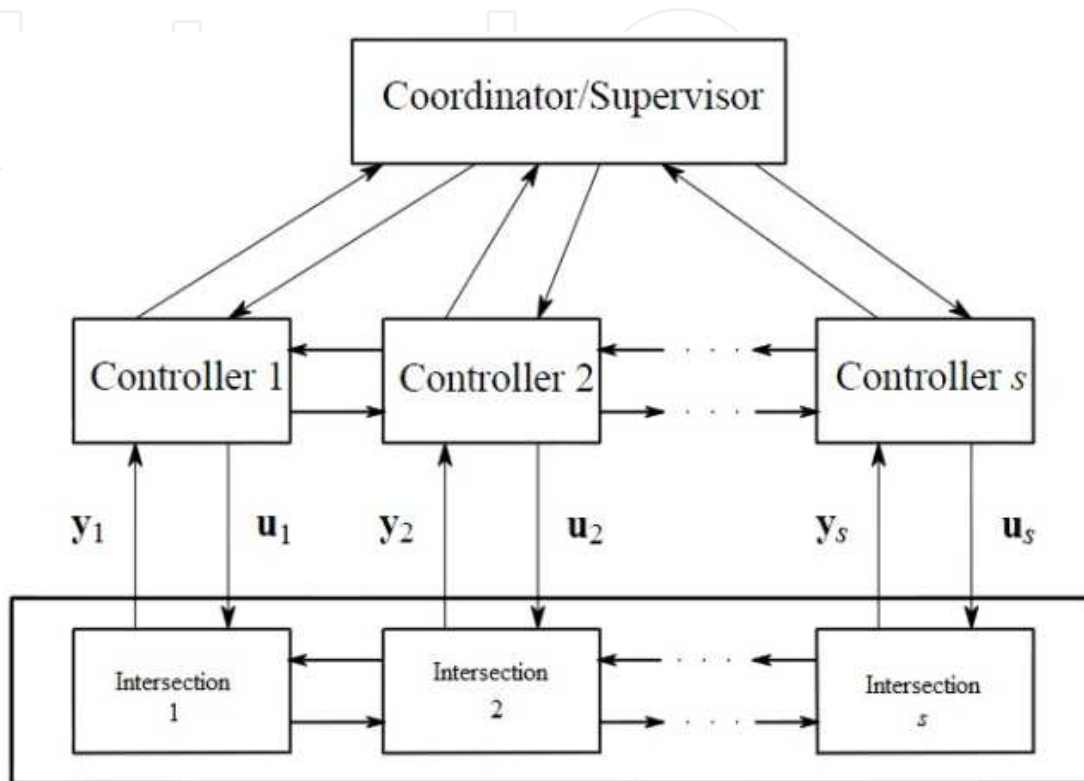

Figure 24. Hierarchical Control Structure

6. Results & discussions

In the simulation we considered 5 intersections as shown in Figure 26 and we tried to compare the results from the proposed approaches. The simulation was done using MATLAB 2008 with the following assumptions:

- Distance between each intersection is known (1 km).
- Average speed is 70 Km/h.
- Estimated time to travel from one intersection to another with 70 Km/h is around 45 sec.
- Flow of traffic is smooth and no major interruption.
- Each intersection operates in 4 phase's mode as default, which means that every two parallel directions will run at the same time to maximize the flow.
- The average of arrivals for each parallel direction will be taken as input. Figure 11 shows the considered phases ($\{N, S\}, \{E, W\}, \{NW, SE\}, \{ES, WN\}$).
- Simulation runs for 30 minutes.

The arrival rate per min, the phase selection and service time (Green period T_g) are shown in the Table 1 while the level of information exchanged is shown in Table 2. In our simulation we considered the first two approaches. When we look to Table 1, we can see that at intersection 1, we started with phase 1, then by the time the flow will reach to intersection 2, which is around 45 seconds, the incoming flow plus the existing flow will move together without stoppage and same will happen at intersection 3, this explanation is shown clearly in Figure 25. That shows the beauty of Quasi Decentralized approach over the Decentralized itself, where in the Quasi we have benefited from the limited communication over a network to smooth and maximize the flow in certain direction between intersections. However, in case we are building our system on lossy communication links, then there is a chance to have a packet dropout or delay or some induced errors, still the system can take care of that but this is part is not included in this chapter.

I1			I2			I3			I4			I5		
Phase	Tg	Q	Phase	Tg	Q	Phase	Tg	Q	Phase	Tg	Q	Phase	Tg	Q
1	31	38	2	43	29	3	19	43	4	20	22	1	42	34
2	19	27	1	45	34	2	43	20	2	21	22	2	35	28
4	15	10	3	17	9	1	45	7	3	20	8	4	15	7
3	15	10	4	16	8	4	17	5	1	21	8	3	15	8

Table 1. Car Arrivals Rate /Min (Q) , Phase Selection and Service Time (T_g) for Each Intersection

	Decentralized	Quasi Decentralized	Distributed	Hierarchical
Traffic Arrival	Y	Y	Y	Y
Phase Selection (prev. intersection)	N	Y	Y	Y
Traffic Arrival previous intersection	N	N	Y	Y
Green Time	N	N	Y	Y
Traffic Jam Info	N	N	N	Y
Avg arrivals speed	N	N	Y	Y

Table 2. Data Exchange in Each Approach

I1		I2		I3		I4		I5	
Dec	Quasi	Dec	Quasi	Dec	Quasi	Dec	Quasi	Dec	Quasi
1	1	1	4	1	3	1	1	2	2
2	2	2	1	2	4	2	2	1	1
3	3	4	2	3	1	3	3	3	4
4	4	3	3	4	2	4	4	4	3

Table 3. Decentralized & Quasi Phase Selection

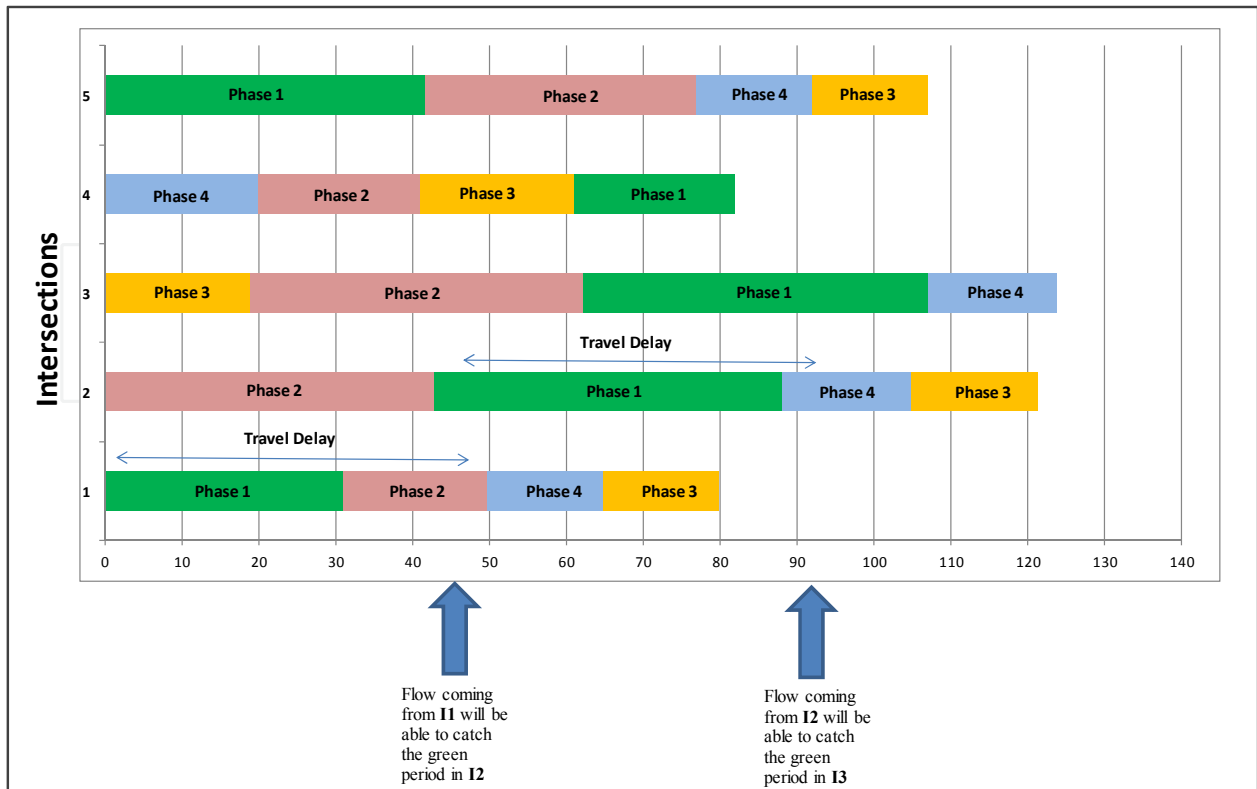

Figure 25. Phase Selection in Each Intersection to maximize the flow from intersection 1 up to 3

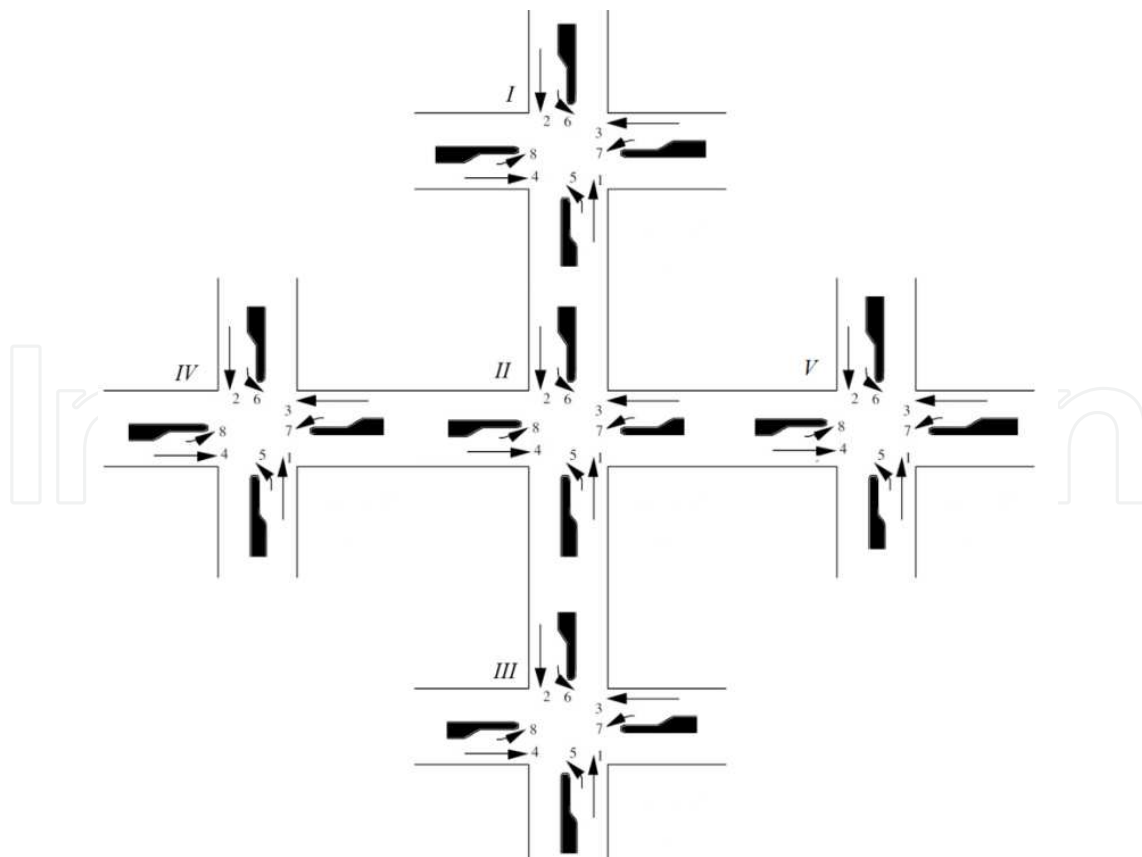

Figure 26. Simulated Traffic Network intersections

The proposed work also can work for the arterial traffic network where you series of intersections along highway and you need to maximize the flow in that heavy traffic highway with minimum number of stops. This scenario shown in Figure 28 and flow can be controlled similar to what we have done in the five intersections example.

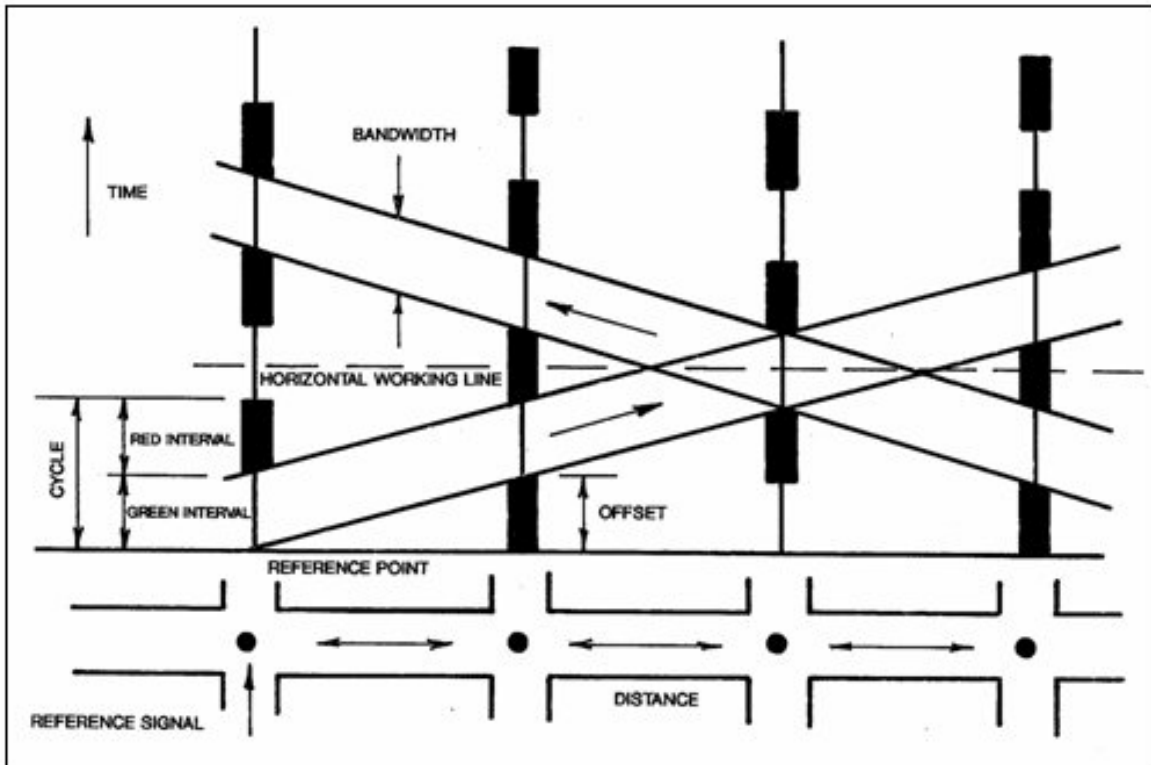

Figure 27. Arterial Traffic Network

7. Future research

In the coming work, simulation will cover more parameters and we will add the other approaches (distributed and hierarchal). Also, more discussions about the effect of network size and the media used for communication between detectors and controllers will be included. The work can be extended easily for arterial traffic network as shown in Figure 29 where also we can apply the hierarchical approach by dividing the network to zones and each zone controller will report to the master coordinator that will monitor the traffic flow in these zones.

Also we can add something about the dilemma zone as shown in figure 30 for safety purpose. A dilemma zone [29] is a range, in which a vehicle approaching the intersection during the yellow phase can neither safely clear the intersection, nor stop comfortably at the stop-line. One of the main contributors to signal-related accidents is the existence of a dilemma zone at signalized intersections. Note that both the length and the location of a dilemma zone may vary with the speed of the approaching vehicles, driver reaction times, and vehicle acceleration/deceleration rates.

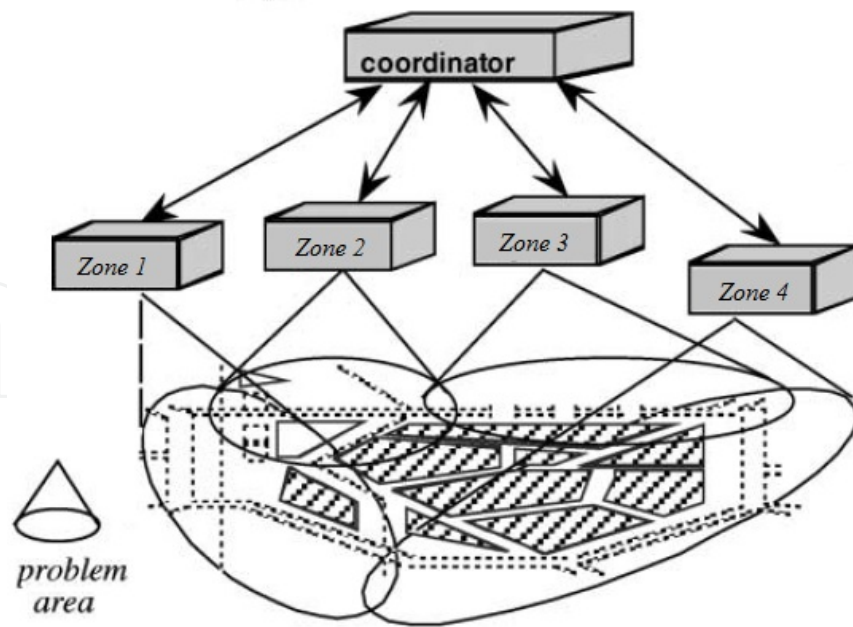

Figure 28. Hierarchical Approach

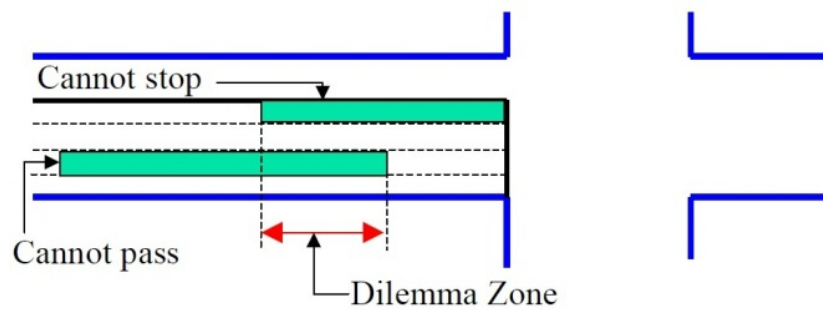

Figure 29. Dilemma Zone

8. Conclusion

In this chapter, we have covered the area of wireless sensors network and we tried to discuss in some details one important application, signalized traffic control, which depends strongly on these devices. Several types of detectors were listed with some information about each type. Then, we introduced some control strategies and concepts from both traffic and control engineering point of view. Finally, simple simulation was done to support the theoretical discussions.

9. Nomenclature

	Definition
Vehicle Presence	Presence (or absence) of a vehicle at a point on the roadway
Flow Rate	Number of vehicles passing a point on the roadway during a specified time period
Occupancy	Percent of time that a point on the roadway is occupied by a vehicle

	Definition
Speed	Distance traveled by a vehicle per unit time
Density	Number of vehicles per lane mi (km)
Jam density	Refers to extreme traffic density associated with completely stopped traffic flow, usually in the range of 185–250 vehicles per mile per lane.
Headway	Time spacing between front of successive vehicles, usually in one lane of a roadway
Queue Length	Number of vehicles stopped in a lane behind the stopline at a traffic signal
Control delay	The component of delay that results when a control signal causes a lane group to reduce speed or to stop; it is measured by comparison with the uncontrolled condition
Cycle	A complete sequence of signal indications
Cycle length	The time required for one complete sequence of signal intervals (phases).
Interval	A period of time in which all traffic signal indications remain unchanged
Lost time	The time during which an intersection is not used effectively by any movement; it is the sum of clearance lost time plus start-up lost time
Phase	The part of the signal cycle allocated to any combination of traffic movements receiving the right-of-way simultaneously during one or more intervals
Split	The percentage of a cycle length allocated to each of the various phases in a signal cycle.
Offset	The time relationship, expressed in seconds or percent of cycle length, determined by the difference between a defined point in the coordinated green and a system reference point.
Red Duration	The period in the signal cycle during which, for a given phase or lane group, the signal is red
Saturation flow rate	The equivalent hourly rate at which previously queued vehicles can traverse an intersection approach under prevailing conditions, assuming that the green signal is available at all times and no lost times are experienced
Start-up Delay	The additional time consumed by the first few vehicles in a queue at a signalized intersection above and beyond the saturation headway, because of the need to react to the initiation of the green phase and to accelerate
Extension of green duration	The amount of the change and clearance interval, at the end of the phase for a lane group, that is usable for movement of its vehicles
Green Duration	The duration of the green indication for a given movement at a signalized intersection
Change and clearance interval	The yellow plus all-red interval that occurs between phases of a traffic signal to provide for clearance of the intersection before conflicting movements are released
Clearance lost time	The time between signal phases during which an intersection is not used by any traffic

Author details

Faisal Ahmed Al-Nasser and Magdi S. Mahmoud
*Systems Engineering Department, King Fahd University of Petroleum & Minerals,
KFUPM, Saudi Arabia*

Acknowledgement

This work is supported by the deanship of scientific research (DSR) at KFUPM through research group project No. RG-1105-1.

10. References

- [1] Chong C. , Kumar S., "Sensor networks: evolution, opportunities, and challenges," *Proceedings of the IEEE*, vol. 91, no. 8, pp. 1247– 1256, 2003.
- [2] Prasad R., Hamid S. , Michael H. , Hesham H. , Jon Y. "A New MAC Approach for Mobile Wireless Sensor Networks". 14th IST Mobile & Wireless Communication Summit, pp. 405 – 410, Dresden 19 -23 June 2005.
- [3] "NEMA TS2 Traffic Controller Assemblies with NTCIP Requirements." National Electrical Manufacturers Association, 1998.
- [4] Skabardonis, A., R.L. Bertini, and B.R. Gallagher. "Development and Application of Control Strategies for Signalized Intersections in Coordinated Systems." *Transportation Research Record* 1634, pp. 110-117. Transportation Research Board, Washington, DC, 1998.
- [5] Zong T. and Thomas U., "Green Extension and Traffic Detection Schemes at Signalized Intersections". *Transportation Research Record: Journal of the Transportation Research Board*, No. 1978, Transportation Research Board of the National Academies, Washington, D.C., 2006, pp. 16–24.
- [6] Christopher M., Hiromal P., Thomas M., James R., Darcy M. , " Operational Evaluation of Wireless Magnetometer Vehicle Detectors at Signalized Intersection". *Transportation Research Record: Journal of the Transportation Research Board*, No. 2192, Transportation Research Board of the National Academies, Washington, D.C., 2010, pp. 11–23.
- [7] Dan M., Hassan C., Ryan L. , " Alternative Vehicle Detection Technologies For Traffic Signal Systems: Technical Report". Report No. FHWA/TX-09/0-5845-1, Feb. 2009.
- [8] "Highway Design Manual," New York State Department of Transportation, June, 2003.
- [9] L.H. Immers, S. Logghe. *Traffic Flow Theory*. KATHOLIEKE UNIVERSITEIT LEUVEN, Course H 111, May 2002.
- [10] Tom V., Krishna R. *Fundamental Relations of Traffic Flow*. Introduction to Transportation Engineering, CHAPTER 31. NPTEL May 24, 2006.
- [11] S. Yksel and T. Basar, "Decentralized Multi-Controller Stabilizability over Communication Channels", *Proc. European Control Conference*, 2007.

- [12] Tubaishat, M, Shang Y., Shi H., "Adaptive Traffic Light Control with Wireless Sensor Networks" , 4th Consumer Communications and Networking Conference - CCNC, 2007.
- [13] Albagul A., Hrairi M., Hidayathullah M.;"Design and Development of Sensor Based Traffic Light System", American Journal of Applied Sciences 3: 1745-1749, 2006.
- [14] WEN Y, PAN J. L. , LE J. F; "Survey On Application Of Wireless Sensor Networks For Traffic Monitoring", International Conference on Transportation Engineering - ICTE, 2007.
- [15] L. K. Chien, "A Real-time Dynamic Traffic. Control System Based on Wireless Sensor Network". International Conference on Parallel Processing Workshops - ICPPW, 2005.
- [16] Leena S., Sudhanshu T., Himakshi A., "Time Optimization for Traffic Signal Control Using Genetic Algorithm", International Journal of Recent Trends in Engineering, Vol 2, No. 2, November 2009.
- [17] Visit H., Jaturapith K., Chris H., "A Multi- Agent Approach for Intelligent Traffic-Light Control", Proc. of the World Congress on Engineering - WCE, 2007 Vol I, July , London, U.K.
- [18] Faisal A., Hosam R., "Simulation of Dynamic Traffic Control System Based on Wireless Sensor Network", IEEE Symposium on Computers & Informatics 2011 (ISCI 2011), pp. 302 – 307.
- [19] Magdi S. Mahmoud, "Decentralized Stabilization of Interconnected Nonlinear Systems with Time-Varying Delays", IEEE Transactions Automatic Control, Vol. 54, No. 11, November Issue, pp. 2663-2668.
- [20] Magdi S. Mahmoud, "Decentralized Reliable Control of Interconnected Systems with Time-Varying Delays", Journal of Optimization Theory and Applications, Vol. 143, No. 3, December Issue, pp. 497-518.
- [21] Magdi S. Mahmoud and Naif B Almutairi, "Decentralized Stabilization of Interconnected Systems with Time-Varying Delays", European J. Control, Vol. 15, No. 6, December Issue, pp. 624-633.
- [22] Magdi S. Mahmoud, "Decentralized Reliable Control of Interconnected Systems with Time-Varying Delays", Journal of Optimization Theory and Applications, Vol. 143, No. 3, December Issue, pp. 497-518.
- [23] Ali Y. Al-Rayyah and Magdi S. Mahmoud, "Decentralized Reliable Control of Interconnected Time-Delays Systems against Sensor Failures", Journal of Optimization Theory and Applications, Vol. 147, No. 2, November Issue, pp. 318-336.
- [24] Magdi S. Mahmoud, "Decentralized Output-Feedback Stabilization for Interconnected Discrete Systems with Unknown Delays", Optimal Control Applications and Methods, Vol. 31, No. 6, November-December Issue, pp. 529-545.
- [25] Magdi S. Mahmoud, (Decentralized Systems with Design Constraints), Springer-Verlag, UK, May 2011. ISBN 978-0-85729-289-6
- [26] Magdi S. Mahmoud, "Design of Control Strategies for Robust Dynamic Routing in Traffic Networks", IET Control Theory and Applications, Vol. 5, No. 15, September Issue, pp. 1716-1728.

- [27] Bo Liu, Yuanqing Xia, Magdi S Mahmoud and Harris Wu, "New Predictive Control Scheme for Networked Control Systems", *Journal of Circuits, Systems and Signal Processing*, DOI: 10.1007/s00034-011-9359-9.
- [28] Magdi S. Mahmoud and F. M. AL-Sunni, "Global Stability Results of Discrete Recurrent Neural Networks with Interval Delay", *IMA J. Mathematical Control and Information*.
- [29] Liu C., Tao H., Tabacek. "Empirical observations of dynamic dilemma zones at signalized intersections". The 86th meeting of the Transportation Research Board, July 2006.

IntechOpen