

# We are IntechOpen, the world's leading publisher of Open Access books Built by scientists, for scientists

4,800

Open access books available

122,000

International authors and editors

135M

Downloads

Our authors are among the

154

Countries delivered to

TOP 1%

most cited scientists

12.2%

Contributors from top 500 universities



WEB OF SCIENCE™

Selection of our books indexed in the Book Citation Index  
in Web of Science™ Core Collection (BKCI)

Interested in publishing with us?  
Contact [book.department@intechopen.com](mailto:book.department@intechopen.com)

Numbers displayed above are based on latest data collected.

For more information visit [www.intechopen.com](http://www.intechopen.com)



# Flow-Injection Spectrophotometric Analysis of Iron (II), Iron (III) and Total Iron

Ibrahim Isildak

*Yildiz Technical University, Faculty of Chemical and Metallurgical Engineering,  
Bioengineering Department, İstanbul,  
Turkey*

## 1. Introduction

Determination of iron in analytical chemistry has become a routine procedure because of its importance in our life. Various chemical forms of iron can be found in natural waters depending on geological area and chemical components present in the environment. The main source of iron in natural waters is from the weathering and leaching of rocks and soils (Dojlido & Best, 1993). Also, metallic iron and its compounds are used in various industrial processes and may enter natural waters through the discharge of wastes. Iron(II) is normally less present in river water (Sangi et al., 2004) and iron (III) can precipitate rapidly by the formation of hydrous iron oxide and hydroxides, which they can absorb other trace metals. Thus, iron ion controls the mobility, bioavailability and toxicity of other trace metals in the natural water system (Wirat, 2008; Lunvongsa et al., 2006). Amounts of iron are widely present in tap, pond, well and underground water, and this metallic ion is essential for biological systems (Ohno et al., 2004; Kawakubo et al., 2004).

As iron is one of the most frequently determined analyte in environmental (water, soil and sediment) samples, many spectrophotometric and/or flow-injection spectrophotometric methods have been developed for iron determination. When trace levels of the iron are concerned, the detection methods applicable are reduced (Tarafer et al., 2005; Weeks & Bruland, 2002; Giokas et al., 2002; Themelis et al., 2001; Bagheri et al., 2000; Pascual-Reguera et al., 1997; Teshima et al., 1996; Tesfaldet et al., 2004; Udnan et al., 2004; Pojanagaroon et al., 2002; van Staden & Kluever, 1998; Asan et al., 2003, 2008; Andac et al., 2009). Flow-injection analysis, as a rapid and precise technique, has found wide application in the determination of iron in several sample matrices (Bowie A.R., et al. 1998; Hirata S., et al. 1999; Qin W., et al. 1998; Kass M., et al. 2002; Saitoh K., et al. 1998; Weeks D.A., et al. 2002; Giokas D.L., et al. 2002; Themelis D.G., et al. 2001; Bagheri H., et al. 2000; Molina-Diaz A., et al. 1998; Teshima N., et al. 1996).

Highly sensitive, selective and rapid flow-injection spectrophotometric analysis (FIA) methods for the determination of iron (II), iron (III) and total iron will be defined under proposed chapter of the book. The methods were based on the reactions of iron (II) and iron (III) with different complexing agents in different carrier solutions in FIA (Asan A. et al., 2010; Andac M. et al., 2009; Asan A. et al., 2008). Several parameters acting on the

determination of iron (II) and iron (III) were examined. The developed methods have been successfully applied to the determination of iron (II), iron (III) and total iron in water and ore samples. The methods were also verified by applying certified reference materials.

## 2. A very sensitive flow-injection spectrophotometric determination method for iron(II) and total iron using 2', 3, 4', 5, 7-pentahydroxyflavone

Spectrophotometric detection based on the measurement of the absorbance at a characteristic wavelength of complex formed between a chelating agent and iron has been mainly applied (Kass M. and Ivaska A. 2002; Saitoh K., et al. 1998; Weeks D.A. and Bruland K.W. 2002; Giokas D.L., et al. 2002; Themelis D.G., et al. 2001; Bagheri H., et al. 2000; Molina-Diaz A., et al. 1998; Teshima N., et al. 1996; Tesfaldet Z.O., et al. 2000; Udnan Y., et al. 2004; Morelli B., et al. 1983; Pojanagaroon T., et al. 2002; van Staden J.F. and Kluever L.G. 1998). A number of other chelating agents that have been reported for the spectrophotometric and/or flow-injection spectrophotometric determination of iron (III) and total iron include 2-thiobarbituric acid (Morelli B., et al. 1983), norfloxacin (Pojanagaroon T., et al. 2002), tiron (Mulaudzi L.V., et al. 2002; Van Staden J.F. and Kluever L.G. 1998), tetracycline (Ahmed M.J. and Roy U.K. 2009) and chlortetracycline (Sultan S.M. and Suliman F. 1992). Flow-injection spectrophotometric methods based on above chelating agents are not either selective, or a masking agent should be used (Wirat R., 2008). However, highly selective, simple and economical methods are still required for the routine determination of iron (II) in different sample matrices. An ultra-sensitive and highly selective, rapid flow-injection spectrophotometric method for the determination of iron (II) and total iron has been proposed. The method was based on the reaction between iron (II) and 2', 3, 4', 5, 7-pentahydroxyflavone (Morin) in slightly acidic solution (pH:4.50) with a strong absorption at 415 nm. The chemical structure of Morin is shown Fig. 1. The reagent itself is sparingly soluble in water and does not absorb in the visible region of the spectrum, therefore, might be well suited for flow-injection analysis of iron (II) and total iron. The method has been successfully applied to the determination of iron (II) and total iron in water samples and ore samples.

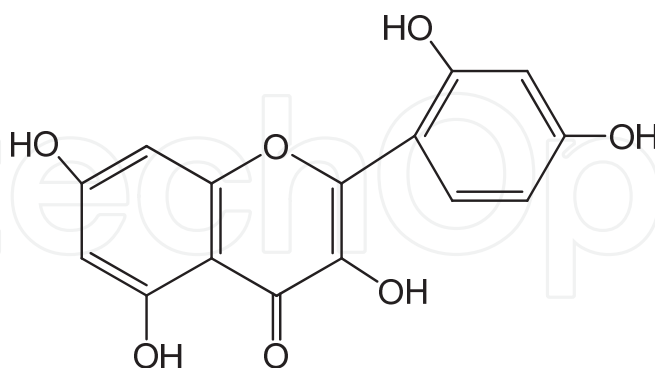

Fig. 1. The chemical structure of 2', 3, 4', 5, 7-pentahydroxyflavone (Morin)

## 2.1 Experimental

### 2.1.1 Reagent and standards

All chemicals used were of analytical reagent grade or the highest purity available. Doubly distilled deionized water was used throughout the study. Glass vessels were cleaned by

soaking in acidified solutions of  $\text{KMnO}_4$  or  $\text{K}_2\text{Cr}_2\text{O}_7$  followed by washing with concentrated  $\text{HNO}_3$ , and were rinsed several times with high-purity deionized water. Stock solutions and environmental water samples (1000 mL each) were kept in polypropylene bottles containing 1 mL of concentrated hydrochloric acid. Standard iron (II) and iron (III) stock solutions were prepared by solving 278.02 mg of iron (II) and 489.96 mg of iron (III) sulphate (Merck) in 0.01 M 100 mL hydrochloric acid to give 0.01 M stock solution of iron (II) and iron (III). Iron (II) and iron (III) working standard solutions were prepared daily by suitable dilution of stock solutions with double deionized water. Standard reference material consisting of 0.085 % Fe (Zn/Al/Cu 43XZ3F) was provided from MBH Analytical Ltd. (UK). Hydrogen peroxide solution 30 % (v/v) used was from Merck.

A stock solution of Morin ( $5 \times 10^{-3} \text{M}$ ) was prepared by dissolving requisite amount of Morin (BDH Chemicals) in 100 mL of ethanol:water (4:96 v/v) because of its low solubility in water only. For spectrophotometric study, morin complex solutions of various metals were prepared by mixing 1 mL of  $1 \times 10^{-4} \text{M}$  standard solution of each metal in double deionised water with a suitable volume of  $1 \times 10^{-4} \text{M}$  Morin solution. All stock solutions were stored in polyethylene containers. All polyethylene containers and glassware used for aqueous solutions containing metallic cations were cleaned with (1+1) nitric acid while the rest were cleaned with 3 % Decon 90, all were rinsed with deionized water before use. The working standard solutions were prepared by appropriate dilution immediately before use. All solutions were degassed before use using a sonicator (LC 30). Reagent carrier solution was composed of Morin in 0.1 M HAc/ Ac<sup>-</sup> buffer (pH:4.50) solution consisting of metanol 4 %.

### 2.1.2 Apparatus

UV-Visible spectra of metal-AcSHA complexes were taken with a Unicam spectrophotometer (GBC Cintra 20, Australia). A Jenway 3040 Model digital pH-meter was used for the pH measurements.

In the FIA system, peristaltic pump (ISMATEC; IPC, Switzerland) 0.50 mm i.d. PTFE tubing was used to propel the samples and reagent solutions. Samples were injected into the carrier stream by a 7125 model stainless steel high pressure Rheodyne injection valve provided with a 20  $\mu\text{L}$  loop. The absorbance of the coloured complex formed ( $\lambda_{\text{max}}$  415 nm) was measured with a UV-Visible spectrophotometer equipped with a flow-through micro cell (Spectra SYSTEM UV 3000 HR, Thermo Separation Products, USA), and connected to a computer incorporated with a PC1000 software programme.

A UNICAM 929 model (Shimadzu AA-68006) flame atomic absorption spectrophotometer with deuterium-lamp background correction was used for the determination of iron in reference to the FIA method. The measuring conditions were as follows: UNICAM hollow cathode lamp, 10 cm 1-slot burner, air-acetylene flame (fuel gas flow-rate 1.50 L/min), 0.2 nm spectral bandwidth, and 7 mm burner height. The wavelength and the lamp current of Fe was respectively 248 nm and 5 mA.

### 2.1.3 General procedure

The FIA system used was simple as shown schematically in Fig.2. The sample solution was introduced into the reagent carrier solution by the Rhodyne injection valve. The complex ( $\lambda_{\text{max}}=415 \text{ nm}$ ) was formed on passage of the reagent and iron (II) ion solution through the

mixing coil. A PTFE tubing (50 cm long) was attached before the flow-through detection cell as a mixing coil. The absorbance of the coloured complex was selectively monitored in the flow-through spectrophotometric cell at 415 nm. The transient signal was recorded as a peak, the height of which was proportional to the iron (II) concentration in the sample, and was used for all measurements. Five replicate injections per sample were made.

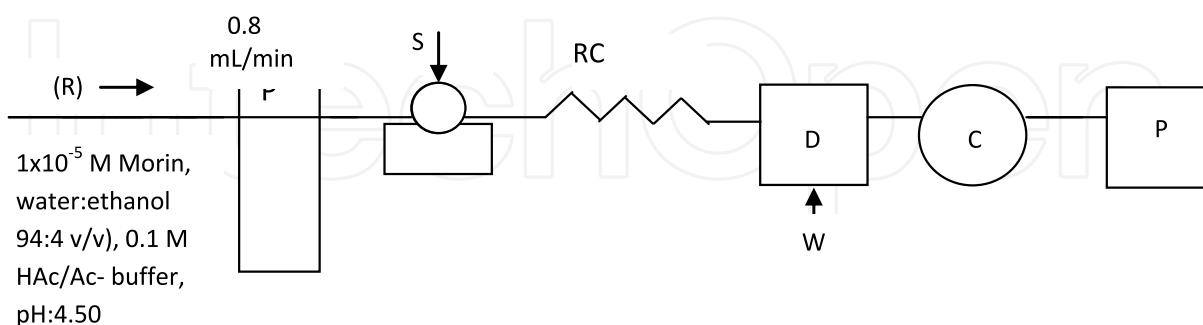

Fig. 2. Flow diagram of the FIA system used. R; reagent carrier solution ( $1 \times 10^{-5}$  M Morin in ethanol: water (4:96 v/v) in 0.1 M HAc/ Ac<sup>-</sup> buffer (pH:4.50)), P, Peristaltic pump, S; Rheodyne sample injection valve, RC; reaction coil (50 cm long, 0.5 mm i.d), D; spectrophotometric detector ( $\lambda_{max} = 415$  nm), W; waste, C; computer, P; printer.

### 2.1.4 Sample preparation procedures

Sea, river and industrial water samples collected in Nalgene plastics were acidified by adding 1 mL of hydrochloric acid (0.1 M) per 100 mL of sample solution behind filtration over 0.45  $\mu$ m Millipore Filter (Millford, MA). After filtration, 20  $\mu$ L of water samples were injected directly into the FIA system for the determination of iron (II). Total iron was determined by reducing of all forms of iron to iron (II) in the procedure described (van Staden J.F. and Kluever L.G. 1998; Asan A., et al. 2003).

A 0.10 g sample of the certified metal alloy (Zn/Al/Cu 43XZ3F) was dissolved in 12 mL of concentrated HCl+HNO<sub>3</sub> (3:1 v/v) in 100 mL beaker. The mixture was heated on a hot plate nearly to dryness; 5 mL HNO<sub>3</sub> was added to complete dissolution and diluted to 100 mL with deionized water. The solution was filtered and transferred quantitatively to 1000 mL volumetric flask and made up to volume with deionized water. 9 mL of this solution was treated with 1 mL of sodium azide (2.5 % w/v) for iron (III) reduction. After the reduction step, 20  $\mu$ L of this solution was used for the determination of total iron (van Staden J.F. and Kluever L.G. 1998).

Metal ore samples (0.10 g) were powdered ( $\geq 500$  mesh) and prepared as in the procedure described above. All analyses were performed with the least possible delay.

## 2.2 Results and discussion

### 2.2.1 Spectrophotometric studies of the Morin-metal complexes

The reaction mechanism of the present method was as reported earlier (Busev A.I., et al. 1981). Job's method of continuous variation and the molar ratio method were applied to ascertain the stoichiometric composition of the complex (MacCarthy P. and Zachary D.H.,

1986). A Fe(II)-Morin (1:2) complex was indicated by both methods. The reaction was very fast. Metal ions react with Morin in aqueous medium in the range pH: 2.0-7.0 forming coloured complexes with different stoichiometry. Absorption spectra's those correspond to solutions of  $5 \times 10^{-5}$  M of iron (II)-Morin complex was measured against a reagent blank and the average molar absorption coefficient of  $6.82 \times 10^4$  L mol<sup>-1</sup> cm<sup>-1</sup> are shown in Fig. 3.

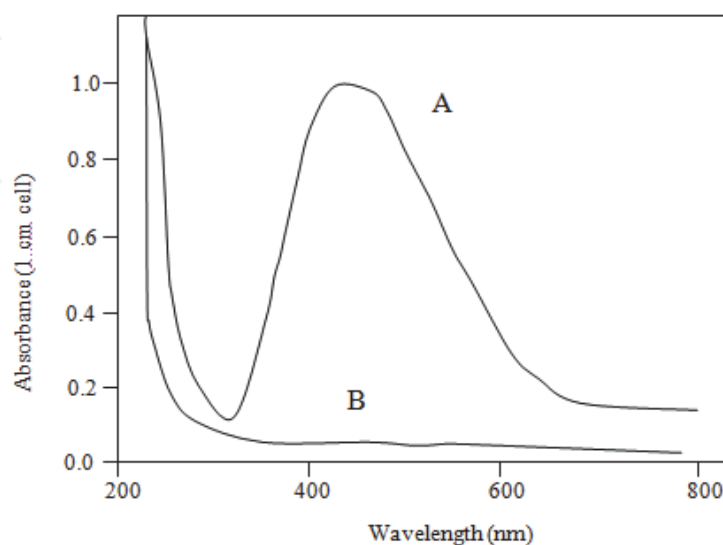

Fig. 3. Absorption spectras of iron (II)-Morin complex and Morin itself. (A) absorption spectra of iron (II)-Morin complex ( $5 \times 10^{-5}$  M) and (B) absorption spectra of the Morin in aqueous solution.

As can be seen from the Fig. 3, the iron (II) Morin complex that has an absorbance maxima at 415 nm. At this wavelength, the Morin itself has no absorption while Morin complexes of all of the tested metal ions and the anions ( not shown) exhibited a negligible absorption.

In order to develop an FIA method based on the above phenomenon, the FIA setup shown in Fig.1 was used. In the FIA system, a complex was formed with an absorption spectrum that showed a maximum at 415 nm, which was in agreement with the value obtained in the spectrophotometric study.

### 2.2.2 Optimisation of chemical variables and the FIA manifold

Various variables closely related to the iron determination were examined using the simple flow-injection analysis system with a fixed iron (II) concentration of  $5 \mu\text{g L}^{-1}$ . The Morin concentration was varied from  $1 \times 10^{-6}$  M to  $1 \times 10^{-2}$  M. The peak height was found to increase with increasing Morin concentration up to  $1 \times 10^{-5}$  M and no noticeable increase was found at higher concentrations. Therefore,  $1 \times 10^{-5}$  M Morin was decided as colour developing component of the carrier solution.

With the concentration of the Morin fixed  $1 \times 10^{-5}$  M, the pH of the carrier solution was varied from 2.0 to 7.0. The interference effect of the iron (III) were found to increase with increasing pH up to 4.5 and remain constant at higher pH. Also, the peak heights were found to increase with increasing pH up to 4.0, remain constant to 4.5 and decreased slightly above that.

The pH of the reagent carrier was however adjusted to 4.5 to obtain maximum peak height and minimum iron (III) interference in the analysis. In order to proceed with the final system design, the effect of sample volume, mixing coil length and flow-rate were studied using Morin at fixed concentration of  $2.5 \times 10^{-4}$  M and pH 4.5.

The sample volume was varied from 5-50  $\mu$ L. The peak height was decreased by decreasing sample size, and the peaks were broadened with increasing sample size due to sample zone dispersion. A sample injection volume of 20  $\mu$ L was selected as a compromise between sensitivity and sample throughput rate.

The mixing coil (RC) was examined by using PTFE tubing's (0,5 mm i.d.) at different lengths ranging between 10 and 150 cm. The peak height was increased with increasing mixing coil length from 10-50 cm. The peak height was decreased for lower concentrations and broadened for higher concentrations at longer coil lengths. A mixing coil length 50 cm was decided convenient for better peak height and shape.

The flow-rate was varied from 0.2 to 2 mL  $\text{min}^{-1}$ . The peak height decreased by increasing flow-rate, probably the extent of reaction decreased. A flow-rate of 0.8 mL  $\text{min}^{-1}$  was selected as a compromise between sample throughput rate and sensitivity.

### 2.2.3 Calibration, accuracy and precision

The developed analytical method was validated by evaluating the linear dynamic range, precision, accurate, limit of detection (LOD) and limit of quantification (LOQ) as well as by applying the standard addition technique. Under the optimized experimental conditions, a linear calibration graph was obtained for 0.01-120 mg  $\text{L}^{-1}$  iron (II) under the optimum conditions with a regression coefficient of 0.9914. The relative standard deviation for the determination of 5  $\mu\text{g L}^{-1}$  iron (II). was 0.85 % for 10 replicate injections. The limit of detection (blank signal plus three times the standard deviation of the blank) was 0.4  $\mu\text{g L}^{-1}$ . The sample throughput of the proposed method was almost 60 sample  $\text{h}^{-1}$ .

### 2.2.4 Interference studies

The interference effects of many cations and anions on the determination of 5  $\mu\text{g L}^{-1}$  iron (II) were examined. The results summarized in Table 1.

Tolerance limit ( $\mu\text{g L}^{-1}$ )	Foreign ion
Over 50000	Cr(III), Al(III), Cd(II), Mn(II), K(I), Na(I), Ag(I), Ca(II), Mg(II), Ba(II), Hg(II), $\text{CN}^-$ , $\text{NO}_3^-$ , $\text{NO}_2^-$ , $\text{SO}_4^{2-}$ , $\text{CO}_3^{2-}$ , Cl-, Br-, $\text{PO}_4^{3-}$ , $\text{NH}_4^+$ , $\text{SCN}^-$ , tartrate, oxalate, citrate, thio-urea
Over 200	Fe (III)

Table 1. Effect of foreign ions on the determination of 5  $\mu\text{g L}^{-1}$  of iron (II) in solution

In the table, the tolerable concentration of each diverse ion was taken as a highest concentration causing an error of  $\pm 3$  %. Most of the ions examined did not interfere with the determination of iron (II). The major interference was iron (III) at the amounts of 200  $\mu\text{g L}^{-1}$ .

It is apparent from the Table 1 that the proposed method can tolerate all of the interfering species tested in satisfactory amounts and it is therefore adequately selective for the determination of Fe (II) and total iron.

### 2.2.5 Applications

The FIA method was applied to the determination of iron (II) and total iron in water samples and ore samples. In order to evaluate the accuracy of the proposed method, the determination of total iron in a standard reference material (Zn/Al/Cu 43XZ3F) and metal alloy sample was carried out. The analytical results obtained by the proposed method are in good agreement with the certified values as is shown in Table 2.

Sample	Total Fe <sup>(1)</sup> (%)	Certified Fe (%)
Alloy (1)	8.23(0.12)	8.58
Alloy (2)	16.15(0.16)	16.62
Std Zn/Al/Cu 43XZ3 F	0.083(0.02)	0.085

Values in parenthesis are the relative standard deviations for n=5 with confidence level of 95 %.

Table 2. Total iron content of iron alloys and standard reference material

For the application of the proposed FIA method to river and sea water samples collected from different sources were analyzed by using both calibration curve and standard addition methods. The values obtained from the calibration curve and the standard addition methods are in good agreement with each other as shown in Table 3.

Samples(1)	Iron (II)(2) (µg L-1)		Total iron (2) (µg L-1)		
	Found(3)	Found(4)	Found(3)	Found(4)	AAS
Kurtun river water	38.33(0.24)	38.55(0.12)	42.33(0.02)	42.91(0.18)	43.65(0.17)
Seaport sea water	68.84(0.32)	68.65(0.24)	85.13(0.12)	85.75(0.06)	86.12(0.12)
Baruthane sea water	47.51(0.18)	47.62(0.14)	57.24(0.04)	57.65(0.15)	58.97(0.24)
Organized industry water	78.84(0.22)	78.65(0.18)	78.13(0.14)	98.75(0.07)	99.12(0.10)

(1) Samples were collected at Samsun, Turkey.

(2) Values in parenthesis are the relative standard deviations for n=5 with confidence level of 95 %.

(3) Calibration curve method.

(4) Standard addition method.

Table 3. Determination of iron (II) and total iron in river and sea water samples

Atomic absorption measurements taken in water samples were also given for comparison in Table 3. The analytical value of total iron in water is slightly in good agreement with that obtained by the AAS method. The results obtained show that the proposed method can be applied in the determination of iron (II) and total iron content in the water samples without a pre-concentration process.



### 3. Flow injection spectrophotometric determination of iron (III) using diphenylamine-4-sulfonic acid sodium salt (Reproduced with permission from the paper of Asan Adem et al., 2008. Copyright of Institute of Chemistry, Slovak Academy of Sciences)

In recent years, low cost automatic and userfriendly analytical methods have become attractive for the determination of trace levels of iron in many kinds of samples (Chen et al., 2006; Pons et al., 2005a; Lunvongsa et al., 2006b). Among these, flow-injection analysis (FIA) is a well accepted technique owing to its high sample throughput, cost effective performance, versatility, flexibility, and ease of operation. Also, FIA is compatible with a wide range of detection systems (Guo & Baasner, 1993; Ensafi et al., 2004). Up to date, FIA for the determination of iron(III) has been generally combined with optical detectors (Pulido-Tofino et al., 2000; Saitoh et al., 1998). The spectrophotometric detector based on measuring the absorbance of colored complexes formed with various chromogenic reagents is one of the most frequently used detectors for the determination of iron in many kinds of samples (Yegorov et al., 1993; Yamamura and Sikes, 1966; Ampan et al., 2002; Bruno et al., 2002; Tesfaldet et al., 2004; Van Staden and Kluever, 1998; Mulaudzi et al., 2002; Reguera et al., 1997; Pojanagaron et al., 2002; Araujo et al., 1997; Asan et al., 2003; Udnan et al., 2004; Alonso et al., 1989; M'uller et al., 1990; Themelis et al., 2001; Kass and Ivaska, 2002; Weeks and Bruland, 2002). A large number of flow-injection spectrophotometric methods have been developed for the determination of iron using desferal (Yegorov et al., 1993), 1,10-phenantroline (Yamamura and Sikes, 1966; Ampan et al., 2002; Bruno et al., 2002; Tesfaldet et al., 2004), tiron (Van Staden and Kluever, 1998; Mulaudzi et al., 2002), ferrozine (Reguera et al., 1997), norfloxacin (Pojanagaron et al., 2002), thiocyanate (Araujo et al., 1997), DMF (Asan et al., 2003), and salicylate (Udnan et al., 2004) as chromogenic reagents. However, many of the proposed methods have a high limit of detection (Alonso et al., 1989; M'uller et al., 1990), suffer from many interfering metal ions, such as Zn and Co (Guo and Baasner, 1993), have a short linear dynamic range (Themelis et al., 2001; Kass and Ivaska, 2002), tedious procedures (Pons et al., 2005b), or low sampling rates (Teixeira and Rocha, 2007; Lunvongsa et al., 2006a).

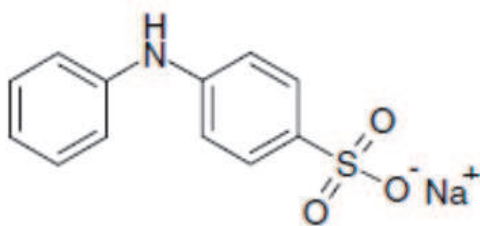

Fig. 4. Structure of the diphenylamine-4-sulfonic acid sodium salt

In this study, a highly sensitive and very simple spectrophotometric flow-injection analysis (FIA) method for the determination of iron (III) at low concentration levels is presented. The method is based on the measurement of absorbance intensity of the red complex at 410 nm formed by iron (III) and diphenylamine-4-sulfonic acid sodium salt (DPA-4-SA). It is a simple, highly sensitive, fast and low cost alternative method using the color developing reagent DPA-4-SA in acetate buffer at pH 5.50 and the flow-rate of 1 mL min<sup>-1</sup> with the sample throughput of 60 h<sup>-1</sup>. The accuracy of the method was evaluated using the standard addition method and checked by the analysis of the certified material Std Zn/Al/Cu 43 XZ3F.

### 3.1 Experimental

#### 3.1.1 Reagents, chemicals, equipment

All reagents used were of analytical reagent grade and the solutions were prepared with double distilled and deionized water. The reagent diphenylamine-4-sulfonic acid sodium salt (DPA-4-SA) was provided by Merck. The chemical formula of the DPA-4-SA is shown in Fig. 4. Standard iron(III) ( $1 \text{ mg mL}^{-1}$ ) and iron(II) ( $5 \text{ mg mL}^{-1}$ ) solutions were prepared by dissolving  $\text{FeCl}_3 \cdot 6\text{H}_2\text{O}$  and  $\text{FeCl}_2 \cdot 4\text{H}_2\text{O}$  in 0.05 M nitric acid and standardized by titration with EDTA. The stock solution of DPA-4-SA ( $1 \times 10^{-2}$  M) was prepared by dissolving the diphenylamine-4-sulfonic acid sodium salt in deionized water. All stock solutions were stored in polyethylene containers. All polyethylene containers and glassware used for aqueous solutions containing metallic cations were cleaned with (1+1) nitric acid while the rest were cleaned with 3 % Decon 90, all were rinsed with deionized water before use. The working standard solutions were prepared by appropriate dilution immediately before use. Interference studies were carried out using chloride or nitrate salts of the metal cations, and sodium or potassium salts of anions. All solutions were degassed before use using a sonicator (LC 30). A certified metal alloy sample consisting of 0.085 % Fe (Zn/Al/Cu 43XZ3F) was provided by MBH Analytical Ltd. (UK).

The pH measurements were carried out using a Jenway 3040 Model digital pH-meter consisting of a contained glass pH electrode. UV-Visible spectra of the DPA-4-SA reagent and metal-DPA-4-SA complexes were taken with a Unicam spectrophotometer (GBC Cintra 20, Australia). A peristaltic pump (ISMATEC; IPC, Switzerland) was used to propel the samples and reagent solutions. Samples were injected into the carrier stream by a 7125 model stainless steel high-pressure Rheodyne injection valve provided with a 20  $\mu\text{L}$  injection loop. Absorbance of the colored complex formed in the flow system was measured using a UV-visible spectrophotometer equipped with a flowthrough micro cell (Spectra SYSTEM UV 3000 HR, Thermo Separation Products, USA), and connected to a computer (IPX Spectra SYSTEM SN 4000) incorporated with a PC 1000 software program. The reaction coil was made of PTFE tubing (1 m, 0.5 mm, i.d.). A UNICAM 929 model (Shimadzu AA-68006) flame atomic absorption spectrophotometer with deuterium-lamp background correction was used for the determination of iron in reference to the FIA method. The measuring conditions were as follows: UNICAM hollow cathode lamp, 10 cm 1-slot burner, airacetylene flame (fuel gas flow-rate  $1.50 \text{ L min}^{-1}$ ), 0.2 nm spectral bandwidth, and 7 mm burner height. The wavelength and the lamp current of iron were 248 nm and 5 mA, respectively.

The manifold of the flow-injection system was similar to that proposed in our previous study (Asan et al., 2003). The peristaltic pump was used for propelling the reagent carrier solution at a flow-rate of  $1 \text{ mL min}^{-1}$ . Samples were injected into the reagent carrier solution, soon load the reaction coil. The reaction zone containing the complex was moving towards the flow-through spectrophotometric detector cell in which the presence of iron(III)-DPA-4-SA complex was selectively monitored, and the absorbance of the complex at 410 nm was continuously recorded.

#### 3.1.2 Preparation of water samples and certified metal alloy solution

Sea and river water samples collected in Nalgene plastics were acidified by adding 1 mL of nitric acid (0.1 M) per 100 mL of sample solution after filtration over a 0.45  $\mu\text{m}$  Millipore

Filter (Millford, MA). After the filtration and pre-treatment, water samples were injected directly into the FIA system for the determination of iron(III).

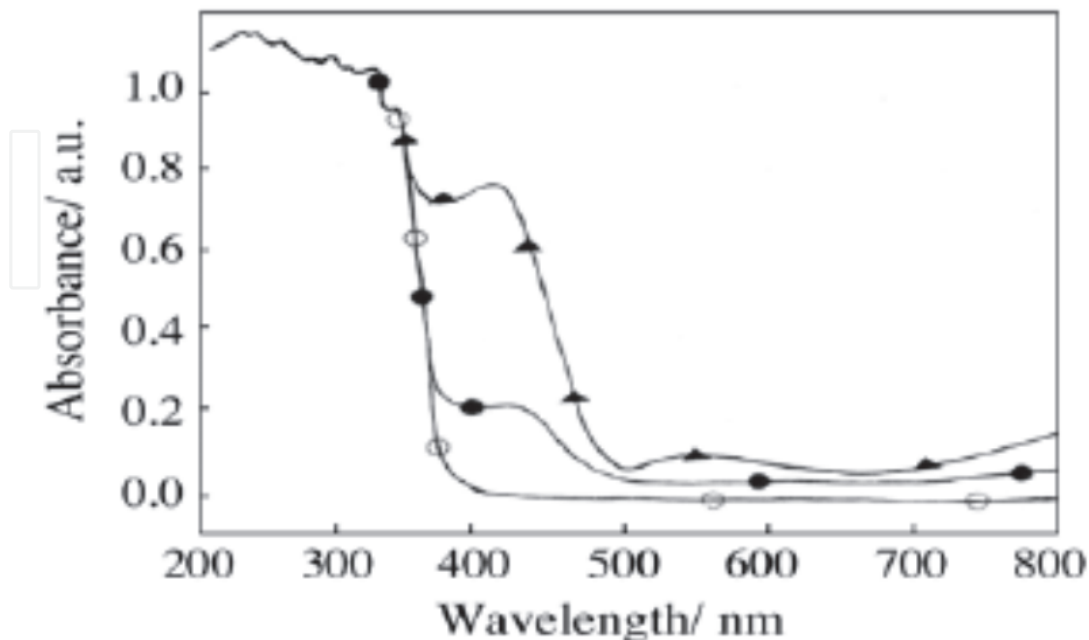

Fig. 5. Absorption spectra for DPA-4-SA and metal-DPA-4-SA complexes: (○)  $5 \times 10^{-5}$  M DPA-4-SA and  $5 \times 10^{-5}$  M of each Co(II), Cu(II), Cr(III), Al(III), Cd(II), Ni(II), Mn(II), Ba(II), Ca(II), Ag(I), K(I), Na(I), Hg(II), Zn(II), and Mg(II); (●)  $5 \times 10^{-5}$  M of Fe(II)-DPA-4-SA; and (▲)  $5 \times 10^{-5}$  M of Fe(III)-DPA-4-SA.

Oxidizing iron(II) to iron(III) was used to determine the total iron amount. Hydrogen peroxide was chosen as the oxidizing agent for the determination of total iron. A concentration of  $0.25 \text{ mol L}^{-1}$  of  $\text{H}_2\text{O}_2$  ensured total oxidation of iron(II) to iron(III) (Pons et al., 2005). Before the determination,  $\text{H}_2\text{O}_2$  (10 mass %) was added to the water sample solution for complete oxidation of iron(II) to iron(III). Then,  $20 \mu\text{L}$  of this solution were injected into the system, as in the procedure described above. Analyses were performed with the least possible delay.

A 0.10 g sample of the certified metal alloy (Zn/Al/Cu 43XZ3F) was dissolved in 12 mL of concentrated HCl +  $\text{HNO}_3$  (3 : 1) in a 100 mL beaker. The mixture was heated on a hot plate nearly to dryness; 5 mL of  $\text{HNO}_3$  were added to complete the dissolution and were diluted to 100 mL with deionized water. The solution was filtered and transferred quantitatively to a 1000 mL volumetric flask and filled up to the volume with deionized water. The volume of 10 mL of this solution was treated with  $\text{H}_2\text{O}_2$  (10 mass %) for iron(II) oxidation. After the oxidation step, the solution was diluted 100 fold, and then,  $20 \mu\text{L}$  of this solution were used for the determination of total iron.

### 3.2 Results and discussion

According to the spectrophotometric studies, iron (II) and iron(III) react with DPA-4-SA in aqueous medium to form complexes. As shown in Fig. 5, the absorption spectra corresponding to solutions of  $5 \times 10^{-5}$  M of each metal complex in water demonstrate strong

absorption for the Fe(III)-DPA-4-SA complex. Iron(III) reacts with DPA-4-SA in the pH range of 2.0–6.0 forming a complex with absorption maxima at 410 nm and molar absorptivity of  $1.60 \times 10^4 \text{ L mol}^{-1} \text{ cm}^{-1}$ . The Fe(II)-DPA-4-SA complex presents only a slight absorption at this wavelength. Seventeen different metals do hardly react with DPA-4-SA in aqueous medium to form complexes. This can be an important advantage when developing a simplified FIA method for iron(III). Therefore, the specific absorbance maximum of the Fe(III)-DPA-4-SA complex at this wavelength can be applied in the selective determination of iron(III) in the flow-injection system.

The optimum experimental conditions were determined using a standard iron(III) solution. The concentration of DPA-4-SA, pH, and the flow-rate were the main variables influencing the intensity of the signal in the FIA system. Optimization of the FIA system was therefore performed by changing these variables one by one while applying  $10 \mu\text{g L}^{-1}$  and  $90 \mu\text{g L}^{-1}$  of iron(III) standard solutions in order to obtain the highest signal and better reproducibility at different concentration levels.

Influence of the DPA-4-SA concentration in the carrier solution on the peak height was examined by changing the DPA-4-SA concentration in the range of  $1 \times 10^{-2} \text{ M}$  to  $5 \times 10^{-4} \text{ M}$  in an acetate buffer solution (pH = 5.5), at the flow rate of  $1 \text{ mL min}^{-1}$ . Maximum peak heights were found using  $1 \times 10^{-3} \text{ M}$  of the DPA-4-SA solution for both,  $10 \mu\text{g L}^{-1}$  and  $90 \mu\text{g L}^{-1}$ , iron(III) levels. Therefore,  $1 \times 10^{-3} \text{ M}$  of DPA-4-SA was chosen as the color-developing component of the carrier solution.

The effect of flow-rate on the peak height of  $10 \mu\text{g L}^{-1}$  and  $90 \mu\text{g L}^{-1}$  iron(III) was examined by varying flow-rates from  $0.2 \text{ mL min}^{-1}$  to  $2.0 \text{ mL min}^{-1}$ . Peak heights decreased at flow-rates above  $1.2 \text{ mL min}^{-1}$  and below  $0.7 \text{ mL min}^{-1}$ . Flow-rates below  $0.7 \text{ mL min}^{-1}$  peaks also broadened. In the flow-rates range of  $0.7\text{--}1.2 \text{ mL min}^{-1}$ , there were slight differences in the peak heights. However, taking into consideration the stability of the pump, peak shape, and sampling time, the flow-rate of the reagent carrier solution was adjusted to  $1 \text{ mL min}^{-1}$ . This provided a sampling frequency of  $60 \text{ h}^{-1}$ .

pH of the carrier solution consisting of  $1 \times 10^{-3} \text{ M}$  of DPA-4-SA was adjusted by adding simple acids and bases into the buffer to obtain the pH range of 3.30–6.10. The peak shape and height were found maximum at pH 5.5. Therefore,  $1 \times 10^{-2} \text{ M}$  of the acetate buffer solution at pH 5.5 was used throughout the study.

Reaction coil was used for the interaction of iron(III) and DPA-4-SA in the flow-injection system. The effect of the reaction coil (RC) length was examined by changing the coil length from 10 cm to 150 cm. The peak height decreased with the increase of length due to fast kinetics of the color forming reaction. The 10 cm length reaction coil was chosen since it produced the best peak height together with a good reproducibility.

The calibration graph for the determination of iron(III) was maintained under the optimized conditions as described above. A good linear relationship was observed for iron(III) ranging from  $5 \mu\text{g L}^{-1}$  to  $200 \mu\text{g L}^{-1}$ . The calibration curve equation was  $A = 0.4018C + 2.0196$ ;  $r^2 = 0.9958$ ;  $n = 6$ , where A represents the absorbance measured as peak height and C the iron concentration in  $\mu\text{g L}^{-1}$ . The confidence limits of the intercept and the slope were calculated at the 95 % confidence level. The same calibration graph can be used for the determination of total iron. The detection limit estimated ( $S/N = 3$ ) was  $1 \mu\text{g L}^{-1}$  of iron(III).

The limit of quantification(LOQ) was calculated as recommended (Currie, 1995); based on a ten fold of the standard deviation of 10 consecutive injections of the blank, the value of  $1.65 \mu\text{g L}^{-1}$  was obtained. The reproducibility of the method calculated as the relative standard deviation (RSD) of peak heights obtained from 5 injections of  $10 \mu\text{g L}^{-1}$  iron(III) was 3.5 %.

Possible interferences in the determination of iron(III) were examined under the optimum experimental conditions. The effect of potential interfering ions on the determination of iron was investigated at the 5 % interference level. To carry out this study, 20  $\mu\text{L}$  of a  $20 \mu\text{g L}^{-1}$  iron(III) standard were injected. Table 4 summarizes the tolerance limits of the interfering ions. Most of the ions examined did not interfere with the iron(III) determination up to at least a 50000 fold excesses. The only interfering ion was iron(II), even  $2 \text{mg L}^{-1}$  of iron(II) gave a positive interference.

Tolerance limit ( $\text{mg L}^{-1}$ )	Foreign ion
Over 1000	Co(II), Cr(III), Al(III), Cu(II), Cd(II), Ni(II), Pb(II), Sn(II), Mn(II), Zn(II), K(I), Na(I), Ag(I), Ca(II), Mg(II), Ba(II), Hg(II), $\text{CN}^-$ , $\text{NO}_3^-$ , $\text{NO}_2^-$ , $\text{SO}_4^{2-}$ , $\text{CO}_3^{2-}$ , Cl <sup>-</sup> , Br <sup>-</sup> , $\text{PO}_4^{3-}$ , $\text{NH}_4^+$
Over 2	Fe(II)

Table 4. Effect of foreign ions on the determination of  $20 \mu\text{g L}^{-1}$  of iron(III) in solution

The proposed method was applied in the determination of total iron in river and seawater samples. Iron(III) and total iron were determined according to the FIA procedure as described in the experimental section. The results obtained by both, standard addition and calibration curve, methods were in good agreement with each other. Atomic absorption measurements taken in water samples 1 and 2 are also given for comparison (Table 5).

Sample	Fe(III) <sup>2</sup> ( $\mu\text{g L}^{-1}$ )		Total iron <sup>2</sup> ( $\mu\text{g L}^{-1}$ )		Total iron <sup>2</sup> ( $\mu\text{g L}^{-1}$ )
	Found <sup>3</sup>	Found <sup>4</sup>	Found <sup>3</sup>	Found <sup>4</sup>	AAS
Seaport (Sea water)	45.16 (0.06)	45.92 (0.21)	53.46 (0.19)	53.78 (0.27)	54.93(0.24)
Industry (Sea water)	56.28 (0.18)	56.11 (0.14)	76.45 (0.27)	76.13 (0.15)	78.19(0.16)
Atakum (River water)	21.45 (0.05)	21.18 (0.12)	32.69 (0.08)	31.85 (0.24)	34.47(0.36)
Mert (River water)	38.17 (0.11)	38.12 (0.19)	1.18 (0.04)	41.27 (0.16)	43.76(0.32)

1. Samples were collected at Samsun, Turkey.

2. Values in parantheses are the relative standard deviations for  $n = 5$  with confidence level of 95 %.

3. Calibration curve method.

4. Standard addition method.

Table 5. Analytical results of iron(III) and total iron in natural water samples<sup>1</sup>

The analytical value of total iron in water is in good agreement with that obtained by the AAS method. The accuracy of the proposed method was tested by the analysis of a certified metal alloy solution (MBH Zn/Al/Cu 43XZ3F). Three replicates of the solution using the sampling volume of 20  $\mu\text{L}$  were analyzed. The certified and the obtained values were 0.085 % and  $(0.084 \pm 0.006)$  of iron, respectively. An excellent agreement between the found and

the certified values has been obtained for the certified metal alloy solution. The results obtained show that the proposed method can be applied in the determination of iron(III) and total iron content in water samples without a preconcentration process.

#### **4. Flow injection spectrofluorimetric determination of iron (III) in water using salicylic acid (Reproduced with permission from the paper of Asan Adem et al., 2010. Copyright of Institute of Chemistry, Slovak Academy of Sciences)**

In general terms, sensitivity of the spectrofluorimetric method is much higher than that of the spectrophotometric method. However, fluorescence reagents and methods suitable for the determination of iron are scarce and they suffer from serious interference of some metal cations such as aluminium, copper, and tin or they require a matrix separation step. Also, the reagents used for the determination of iron have a risk of toxicity (Tamm & Kalb, 1993; Yan et al., 1992; Cha et al., 1996; Ragos et al., 1998). Therefore, it is still important to develop simple and economical procedures that could be directly applied to real samples without the matrix separation step and with minimized reagent consumption.

In literature (Cha et al., 1998), salicylic acid has been used as a fluorescence reagent for the spectrofluorimetric determination of iron(III) in batch conditions. Experimentally it was found to be a very sensitive emission reagent for the spectrofluorimetric determination of iron(III) in the absence of iron (II). A very strong emission peak of salicylic acid in aqueous solution, which decreased linearly with the addition of iron(III), occurred at 409 nm with excitation at 299 nm. Also, salicylic acid is a commercially available reagent and it does not have a risk of serious toxicity when compared to the reagents used previously.

A simple and fast flow injection fluorescence quenching method for the determination of low levels of iron(III) in water has been developed. For this purpose, a preconcentration minicolumn consisting of cation-exchange resin was coupled to the FIA system. The use of mini-column in the system provided an improvement in sensitivity and the developed FIA method was successfully applied to the on-line determination of low levels of iron in real samples without the pre-concentration process. Fluorimetric determination was based on the measurement of the quenching effect of iron on salicylic acid fluorescence. An emission peak of salicylic acid in aqueous solution occurs at 409 nm with excitation at 299 nm. The effect of interferences from various metals and anions commonly present in water was also studied. The method was successfully applied to the determination of low levels of iron in real samples (river, sea, and spring waters).

#### **4.1 Experimental**

Analytical reagent grade chemicals were employed for the preparation of the standard, and the solutions were prepared using double distilled water. Standard iron(III) and iron (II) stock solutions ( $5 \times 10^{-3}$  mol L<sup>-1</sup> Fe(III) and Fe(II)) were prepared by dissolving  $\text{FeNH}_4(\text{SO}_4)_2 \cdot 12\text{H}_2\text{O}$  and  $\text{Fe}(\text{NH}_4)_2(\text{SO}_4)_2 \cdot 6\text{H}_2\text{O}$  in water and were standardized by titration with EDTA. Iron(II) and iron(III) working standard solutions were prepared by appropriate dilution of the stock solutions with water immediately before use. Hydrogen peroxide solution, 30 mass %, was purchased from Merck (Darmstadt, Germany). Standard solutions of other metal ions (all of them from Merck (Darmstadt, Germany)) at different concentrations were prepared with doubly distilled water.

Buffer solution,  $0.1 \text{ mol L}^{-1} \text{ NH}_4^+ / \text{NH}_3$  at pH: 8.5, was used to produce analytical signal in the FIA system. Salicylic acid was provided from Merck (Darmstadt, Germany). Standard salicylic acid solutions were prepared daily by dissolving the appropriate amount of salicylic acid in an ethanol:water mixture (30 : 70). The reagent carrier solution was composed of  $2 \times 10^{-6} \text{ mol L}^{-1}$  salicylic acid and  $0.1 \text{ mol L}^{-1} \text{ NH}_4^+ / \text{NH}_3$  buffer solution (90:10) at pH 8.5.

Fluorescence measurements for the batch experiments were performed with an SPF-500 model spectrofluorometer (American Instrument Co, Jessup, USA) using 1 cm quartz cells. Instrument excitation and emission slits were fixed at 10 nm. The light source was a 150 W Xenon lamp (American Instrument Co, Jessup, USA). Excitation and emission wavelengths were set at 299 nm and 409 nm, respectively. An eight-channel ISMATEC IPC peristaltic pump (Zürich, Switzerland), 0.75 mm i.d. PTFE tubing, was used to propel the samples and reagent solutions. Samples were injected into the carrier stream by a Rheodyne injection valve provided with a 20  $\mu\text{L}$  loop. A Varian 2070 spectrofluorometer (Tokyo, Japan) using a 15  $\mu\text{L}$  flow cell was used for the on-line measurements of analytical signals. Instrument excitation and emission slits were set at 20 nm. The light source was an ozoneless 75 W Xenon lamp (Tokyo, Japan). A strip chart recorder was attached to the instrument. Cation-exchange resin, sodium form of A650 W (100–200 mesh), was provided by the BioRad Labs (Hercules, CA, USA). The cation-exchange resin minicolumn (6 cm long, 2 mm i.d) was prepared in our laboratory.

pH measurements were carried out using a Jenway digital pH-meter model 3040 (Essex, England). An ATI UNICAM 929 model AAS (Cambridge, UK) flame atomic absorption spectrophotometer with a deuterium-lamp background correction was used for the determination of iron in reference to the FIA method. The measuring conditions were as follows: UNICAM hollow cathode lamp, 10 cm 1-slot burner, air-acetylene flame (fuel gas flow-rate of  $1.50 \text{ L min}^{-1}$ ), 0.2 nm spectral bandwidth, and 7 mm burner height. The wavelength and the lamp current of iron were 248 nm and 5 mA, respectively. The flow injection manifold was similar to that proposed in our previous study (Isildak et al., 1999). Peristaltic pump was used to transport the reagent carrier solution through the system. The sample was injected using an injection loop (20  $\mu\text{L}$ ). The reagent carrier solution and the sample were allowed to mix in the flow stream and in the mini-column. The decrease in the fluorescence intensity of the salicylic acid as a function of Fe(III) concentration was measured in the flow cell using 299 nm for excitation and 409 nm for emission. Water samples were obtained from different places of the river, sea and thermal spring in Samsun, Turkey. They were filtered through a 0.45  $\mu\text{m}$  Millipore Filter (Millford, MA, USA). Water samples were split into two portions: one part was directly injected into the FIA system for the determination of iron(III). Before the analysis of the other part, 1 mL of  $\text{H}_2\text{O}_2$  (10 mass %) was added to a 9 mL sample solution for complete oxidation of iron(II) to iron(III). Then, 20  $\mu\text{L}$  of this solution were injected into the system for the determination of total iron, as in the procedure described above.

A 0.10 g sample of the certified metal alloy (Zn/Al/Cu 43XZ3F) was dissolved in 12 mL of concentrated  $\text{HCl} + \text{HNO}_3$  (3 : 1) in a 100 mL beaker. The mixture was heated on a hot plate nearly to dryness; 5 mL of  $\text{HNO}_3$  were added to complete the dissolution, and the solution was diluted to 100 mL with deionized water, filtered and transferred quantitatively to a 1000 mL volumetric flask and filled up to the volume with deionized water. The volume of 10 mL

of this solution was treated with H<sub>2</sub>O<sub>2</sub> (10 mass %) for iron(II) oxidation. After the oxidation step, the solution was diluted 100 fold, and then, 20  $\mu$ L of this solution were used for the determination of total iron.

## 4.2 Results and discussion

Fig. 6 shows the fluorescence emission spectra of  $5 \times 10^{-5}$  mol L<sup>-1</sup> salicylic acid in a buffer solution at pH 8.5 before and after the reaction with  $1 \times 10^{-5}$  mol L<sup>-1</sup> iron(II) and iron(III), respectively, in batch experiments. As can be seen, the intensity of salicylic acid fluorescence decreased significantly in the presence of iron(III). From these spectra, the emission wavelength chosen for the FIA measurement was 409 nm, using 299 nm for the fluorescence excitation.

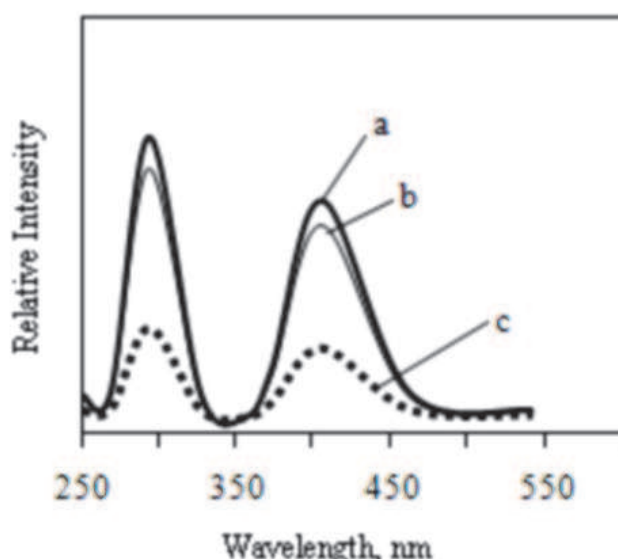

Fig. 6. Emission spectrum of  $5 \times 10^{-5}$  M salicylic acid in batch experiment (in the absence and presence of  $1 \times 10^{-5}$  M Fe(III) and  $1 \times 10^{-5}$  M Fe(II) ions): a) salicylic acid, b) salicylic acid + Fe(II), c) salicylic acid + Fe(III).

### 4.2.1 Optimization of FI manifold

Optimization of the flow system was performed to establish the best FIA variables. A fixed standard Fe (III) solution,  $10 \mu\text{g L}^{-1}$  was injected into the flow system for the determination of optimum experimental conditions. The main variables influencing the intensity of the signal were: flow-rate, pH, and the concentration of salicylic acid. Therefore, optimization of the FIA system was carried out by changing these variables one by one.

The effect of salicylic acid in the carrier solution on the peak height was examined by changing the amount of salicylic acid in the range of  $5 \times 10^{-7}$ – $5 \times 10^{-5}$  mol L<sup>-1</sup> in buffer solution at pH 8.5, at the flow rate of  $1.0 \text{ mL min}^{-1}$ . Peak heights were found maximum using a  $2 \times 10^{-6}$  mol L<sup>-1</sup> salicylic acid solution for  $10 \mu\text{g L}^{-1}$  iron(III) levels. Therefore,  $2 \times 10^{-6}$  mol L<sup>-1</sup> salicylic acid was chosen as the fluorescence reagent in the carrier solution.

The effect of flow-rate on the peak height of iron(III) was examined by varying the flow-rate from  $0.5 \text{ mL min}^{-1}$  to  $1.5 \text{ mL min}^{-1}$ . Peak heights decreased at flow-rates above  $1.2 \text{ mL min}^{-1}$ .



and below  $0.8 \text{ mL min}^{-1}$ . Below  $0.8 \text{ mL min}^{-1}$  the peaks also broadened. Between the flow-rates of  $0.8\text{--}1.2 \text{ mL min}^{-1}$ , there were slight differences in the peak heights. Considering the stability of the pump, peak height, and sampling time, the flow-rate of the reagent carrier solution was adjusted to  $1.0 \text{ mL min}^{-1}$ . This provided the sampling frequency of  $60 \text{ h}^{-1}$ . pH of the carrier solution consisting of  $2 \times 10^{-6} \text{ mol L}^{-1}$  salicylic acid was adjusted by an  $\text{NH}_4^+ / \text{NH}_3$  buffer solution to obtain the pH range of  $8.0\text{--}10.0$ . The peak heights were found maximum at pH 8.5. Therefore, a  $0.1 \text{ mol L}^{-1} \text{ NH}_4^+ / \text{NH}_3$  buffer solution (90 : 10) at pH 8.5 was used throughout the study.

The use of a mini-column in the flow-injection system provided an improvement in the sensitivity and selectivity due to on-line pre-concentration and fast interaction of metal ions with reagent molecules in the carrier solution (Isildak et al., 1999). A mini-column packed with strong cation-exchange resin was selected because metal ions are strongly bound by the resin so that low amounts of the resin can be used. Higher amounts of the resin minimized the use of higher flowrates due to an increase in the hydrodynamic pressure. Sampling time in the FIA system depends on the retention time in the cation exchange mini-column and the residence time in the tubing in the flow-path. The effect of the column length was examined by changing the column length between 2 cm and 10 cm. From the results obtained, 6 cm column length brought the best results for the peak shape and sensitivity for iron for all concentration levels studied.

Also a mixing coil and a mini-column packet with silica and glass beads were inserted into the analytical path instead of the cation-exchange resin minicolumn. However, the observed peak height and sensitivity for iron(III) were lower and poorer, for all concentration levels studied. This result can originate from the short remaining time of iron(III) in each column, which means a narrow interacting zone of the sample. Finally, a mini-column packed with strong cation-exchange resin was used throughout the study for the determination of iron(III). Indeed, a significant improvement of the selectivity and sensitivity was observed.

#### 4.2.2 Analytical performance characteristics

Analytical performance characteristics of the method were evaluated under optimum conditions. Fig. 7 shows typical flow signals for iron(III) obtained by the proposed method. The reaction of iron(III) with salicylic acid resulted in negative peaks due to the fluorescence quenching of salicylic acid. Under the optimum working conditions, calibration graphs were prepared from the results of triplicate measurements of iron(III) standard solutions of increasing concentration. The calibration graph showed a good linearity from  $5\text{--}100 \mu\text{g L}^{-1}$  iron(III) with the linear regression equation:  $Y = 0.0353X + 0.0909$ , where Y is the peak height (cm) and X is the concentration of iron(III) in  $\mu\text{g L}^{-1}$ . The correlation coefficient was  $r^2 = 0.9963$  and the relative Standard deviation (RSD) of the method based on five replicate measurements of  $10 \mu\text{g L}^{-1}$  iron(III) was 1.25 % for a  $20 \mu\text{L}$  injection volume. The limit of detection (determined as three times the standard deviation of the blank) was  $0.3 \mu\text{g L}^{-1}$  and the sampling rate was  $60 \text{ h}^{-1}$ . The limit of quantification (LOQ) was calculated as recommended (Currie, 1995); based on a ten fold standard deviation of ten consecutive injections of the blank, the value of  $1.12 \mu\text{g L}^{-1}$  was obtained.

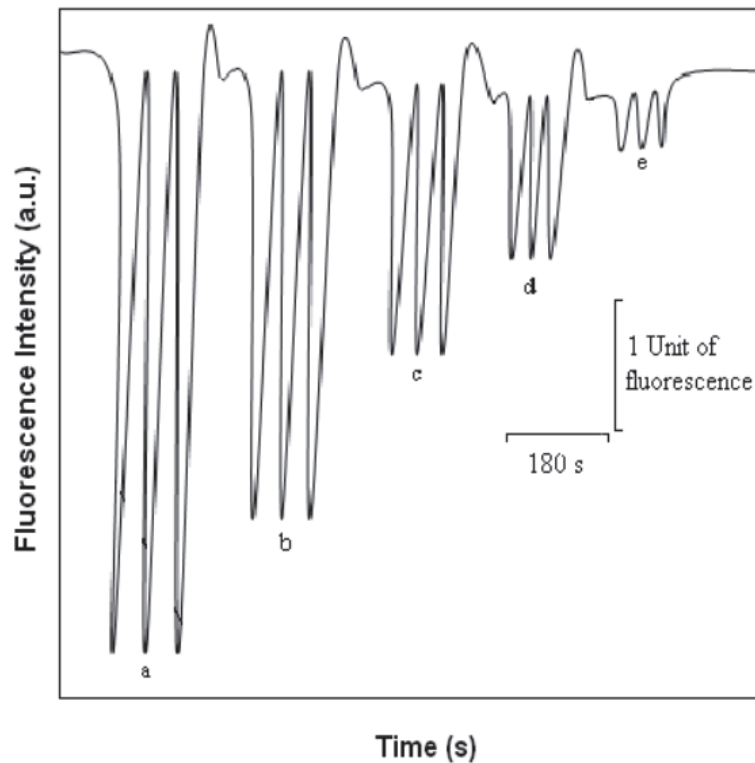

Fig. 7. Flow signal for iron(III) standard solutions by fluorescence quenching-FIA a) 100  $\mu\text{g L}^{-1}$ , b) 75  $\mu\text{g L}^{-1}$ , c) 50  $\mu\text{g L}^{-1}$ , d) 25  $\mu\text{g L}^{-1}$ , and e) 5  $\mu\text{g L}^{-1}$  when using the optimized FIA system.

#### 4.2.3 Interference study

The effect of diverse ions on the detection of iron by the present system were examined using a solution containing 10  $\mu\text{g L}^{-1}$  iron(III) and one of the other ions. The tolerable concentration of each diverse ion was taken as the highest concentration causing the error of  $\pm 5\%$ . The results are summarized in Table 6.

Tolerance limit ( $\text{mg L}^{-1}$ )	Foreign ion
No interfere	$\text{CO}_3^{2-}$ , $\text{SCN}^-$ , $\text{Br}^-$ , $\text{SO}_4^{2-}$ , $\text{Ca}^{2+}$ , $\text{Zn}^{2+}$
Over 50 000	$\text{Co(II)}$ , $\text{Cr(III)}$ , $\text{Al(III)}$ , $\text{Cu(II)}$ , $\text{Cd(II)}$ , $\text{Ni(II)}$ , $\text{Pb(II)}$ , $\text{Mn(II)}$ , $\text{K(I)}$ , $\text{Na(I)}$ , $\text{Ag(I)}$ , $\text{Mg(II)}$ , $\text{Ba(II)}$ , $\text{Hg(II)}$ , $\text{CN}^-$ , $\text{NO}_3^-$ , $\text{NO}_2^-$ , $\text{Cl}^-$ , $\text{PO}_4^{3-}$ , $\text{NH}_4^+$
Over 100	$\text{Fe(II)}$

Table 6. Effect of foreign ions on the determination of 10  $\mu\text{g L}^{-1}$  of iron(III) in solution

#### 4.2.4 Analysis of water samples

The proposed method was applied to the determination of iron in river, sea, and thermal spring water samples to evaluate its applicability. Iron(III) and total iron were determined according to the FIA procedure as described in the experimental section. Table 7 shows the analytical results of iron(III) and total iron. Atomic absorption measurements taken were

also given for comparison. The results obtained with the standard addition and the calibration curve methods, and the AAS measurements were in good agreement with each other.

Sample	Fe(III) <sup>2</sup> (µg L <sup>-1</sup> )		Total iron <sup>2</sup> (µg L <sup>-1</sup> )		AAS	Ec (%)
	Found <sup>3</sup>	Found <sup>4</sup>	Found <sup>3</sup>	Found <sup>4</sup>		
Seaport (Sea water)	52.16 (0.12)	52.92 (0.21)	67.25 (0.10)	67.52 (0.12)	66.98 (0.05)	0.60
Atakum(River water)	25.41 (0.10)	26.01 (0.19)	37.41 (0.14)	38.01 (0.17)	38.15 (0.07)	1.16
Kurtun river	32.84 (0.24)	33.57 (0.28)	48.14 (0.19)	48.57 (0.27)	49.12 (0.09)	1.55
Spring water (1)	10.95 (0.15)	11.25 (0.27)	16.75 (0.32)	16.20 (0.28)	16.62 (0.18)	0.88
Spring water (2)	12.65 (0.09)	13.18 (0.12)	21.83 (0.08)	21.32 (0.24)	21.75 (0.14)	0.81
Spring water (3)	38.17 (0.11)	38.12 (0.19)	52.54(0.04)	52.73 (0.16)	52.95 (0.12)	0.60

1. Samples were collected at Samsun, Turkey.

2. Values in parantheses are the relative standard deviations for  $n = 5$  with confidence level of 95 %.

3. Calibration curve method.

4. Standard addition method.

Table 7. Determination of total iron in water samples<sup>1</sup>

Accuracy of the proposed method was also tested by analyzing a certified metal alloy solution (MBH Zn/Al/Cu 43XZ3F). Three replicates of the solution using the sampling volume of 20 µL were analyzed. The certified and the obtained values were 0.085 % and (0.084 ± 0.006) % of iron, respectively. An excellent agreement between the found and the certified values was obtained for the certified metal alloy solution. The obtained results show that the proposed method can be applied to the determination of iron(III) and total iron content in water samples without a pre-concentration process.

### 5. A simple flow injection spectrophotometric determination method for iron (III) based on O-acetylsalicylhydroxamic acid complexation (Reproduced with permission from the paper of Andac Muberra et al., 2009. Copyright of Institute of Chemistry, Slovak Academy of Sciences)

1,10-phenanthroline and salicylic acid are the most reported chelating agents applied for the determination of iron(III) and total iron after oxidation to iron(III) (Tessalidet et al., 2004; Udnan et al., 2004). A number of other chelating agents that have been reported for the spectrophotometric and/or flow-injection spectrophotometric determination of iron(III) and total iron include 2-thiobarbituric acid (Morelli, 1983), norfloxacin (Pojanagaron et al., 2002) tiron (van Staden & Kluever, 2002) DMF (Asan et al., 2003), tetracycline (Sultan et al., 1992) and chlortetracycline (Wirat, 2008). Flow-injection spectrophotometric methods based on the above chelating agents are either not selective, or a masking agent has to be used. However, highly selective, simple and economical methods for routine determination of iron(III) in different sample matrices are still required. In the present study, a simple and rapid flow-injection spectrophotometric method for the determination of iron (III) and total iron is proposed. The method is based on the reaction between iron (III) and O-acetylsalicylhydroxamic acid (AcSHA) in a 2 % methanol solution resulting in an intense violet complex with strong absorption at 475 nm. The reagent itself is sparingly soluble in

water and did not absorb in the visible region of the spectrum, therefore, it might be well suited for flow-injection analysis of iron(III) and total iron. An addition of copper sulphate ( $1 \times 10^{-4}$  mol L<sup>-1</sup>) into the reagent carrier solution resulted in baseline absorbance, and possible interfering ions were eliminated without a significant decrease in the sensitivity of the method. The method was successfully applied in the determination of iron (III) and total iron in water and ore samples. The method was verified by analysing a certified reference material Zn/Al/Cu 43XZ3F and also by the AAS method.

## 5.1 Experimental

All chemicals used were of analytical reagent grade, and solutions were prepared from double deionised water. Standard iron(II) and iron(III) stock solutions were prepared by dissolving 278.02 mg of iron(II) and 489.96 mg of iron(III) sulphate (Merck; Darmstadt, Germany) in 100 mL of 0.01 mol L<sup>-1</sup> hydrochloric acid to give 0.01 mol L<sup>-1</sup> stock solution of iron(II) and iron(III). Iron(II) and iron(III) working standard solutions were prepared daily by suitable dilution of the stock solutions with double deionised water. Standard reference material consisting of 0.085 % Fe (Zn/Al/Cu 43XZ3F) was provided from MBH Analytical Ltd. (UK). Hydrogen peroxide solution of 30 vol. % was obtained from Merck. AcSHA was synthesised according to the procedure described previously (Asan et al., 2003). A stock solution of AcSHA (0.01 mol L<sup>-1</sup>) was prepared by dissolving 0.095 g of AcSHA in 100 mL of aqueous methanol (2 vol. %). For the spectrophotometric study, AcSHA complex solutions of various metals were prepared by mixing 1 mL of  $1 \times 10^{-4}$  mol L<sup>-1</sup> standard solution of each metal in double deionised water with the suitable volume of  $1 \times 10^{-4}$  mol L<sup>-1</sup> AcSHA stock solution. Reagent carrier solution was composed of AcSHA in a 2 % methanol solution and  $1 \times 10^{-4}$  mol L<sup>-1</sup> CuSO<sub>4</sub> in 0.001 mol L<sup>-1</sup> HCl 98 % (pH 2.85). UV-VIS spectra of metal-AcSHA complexes were taken with a Unicam spectrophotometer (GBC Cintra 20, Australia). A Jenway 3040 Model digital pH-meter was used for the pH measurements. In the FIA system, a peristaltic pump (ISMATEC; IPC, Switzerland) 0.50 mm i.d. PTFE tubing was used to propel the samples and reagent solutions. Samples were injected into the carrier stream by a 7125 model stainless steel high pressure Rheodyne injection valve provided with a 20 µL loop. Absorbance of the coloured complex formed was measured with a UV-VIS spectrophotometer equipped with a flowthrough micro cell (Spectra SYSTEM UV 3000 HR, Thermo Separation Products, USA), and connected to a computer incorporated with a PC1000 software programme. A UNICAM 929 model (Shimadzu AA-68006) flame atomic absorption spectrophotometer with a deuterium-lamp background correction was used for the determination of iron in reference to the FIA method. The measuring conditions were as follows: UNICAM hollow cathode lamp, 10 cm 1-slot burner, air-acetylene flame (fuel gas flow-rate 1.50 L min<sup>-1</sup>), 0.2 nm spectral bandwidth, and 7 mm burner height. The wavelength and the lamp current of iron were 248 nm and 5 mA, respectively.

The FIA system used, similar to that proposed in our previous works (Asan et al., 2003), is quite simple. The sample solution was introduced into the reagent carrier solution by the Rhodyne injection valve. A water-soluble complex ( $\lambda_{\text{max}} = 475$  nm) was then formed on the passage of the reagent carrier solution in the mixing coil. As a mixing coil, PTFE tubing (50 cm long) was attached before the flow-through detection cell. The absorbance of the coloured complex was selectively monitored in the cell at 475 nm. The transient signal was recorded as a peak, the height of which was proportional to the iron(III) concentration in the sample, and it was used in all measurements. Five replicate injections per sample were made.

Sea and river water samples collected in Nalgene plastics were acidified by adding 1 mL of nitric acid ( $0.1 \text{ mol L}^{-1}$ ) per 100 mL of sample solution after filtration over a  $0.45 \mu\text{m}$  Millipore Filter (Millford, MA). After the filtration, water samples were injected directly into the FIA system for the determination of iron(III).

Total iron was determined by oxidising iron(II) to iron(III). Hydrogen peroxide was chosen as the oxidising agent for the determination of total iron. A  $0.25 \text{ mol L}^{-1} \text{H}_2\text{O}_2$  concentration ensured total oxidation of iron(II) into iron(III) (Pons, et al., 2005). Before the determination of total iron,  $\text{H}_2\text{O}_2$  (10 mass %) was added to the water sample solution for complete oxidation of iron(II) to iron(III). Then,  $20 \mu\text{L}$  of this solution were injected into the system, as in the procedure described above. A  $0.10 \text{ g}$  sample of the certified metal alloy (Zn/Al/Cu 43XZ3F) was dissolved in  $12 \text{ mL}$  of concentrated HCl and  $\text{HNO}_3$  (3 : 1) in a  $100 \text{ mL}$  beaker. The mixture was heated on a hot plate nearly to dryness;  $5 \text{ mL}$  of  $\text{HNO}_3$  were added to complete the dissolution and the solution was diluted to  $100 \text{ mL}$  with deionised water. The solution was filtered and transferred quantitatively to a  $1000 \text{ mL}$  volumetric flask and filled up to volume with deionised water.  $9 \text{ mL}$  of this solution were treated with  $1 \text{ mL}$  of  $\text{H}_2\text{O}_2$  (10 mass %) for iron(II) oxidation. After the oxidation step,  $20 \mu\text{L}$  of this solution were used in the determination of total iron. Metal ore samples ( $0.10 \text{ g}$ ) were powdered ( $\geq 500$  mesh) and prepared as in the procedure described above. All analyses were performed with the least possible delay.

## 5.2 Results and discussion

### 5.2.1 Spectrophotometric studies of AcSHA-metal complexes

Metal ions react with AcSHA in aqueous media in the range of pH 2.0-10.0 forming coloured complexes with different stoichiometry. These complexes are fairly soluble in aqueous media (O'Brien et al., 1997). Their absorption spectra corresponding to solutions of  $5 \times 10^{-5} \text{ mol L}^{-1}$  metal complexes measured against a reagent blank are shown in Fig. 8.

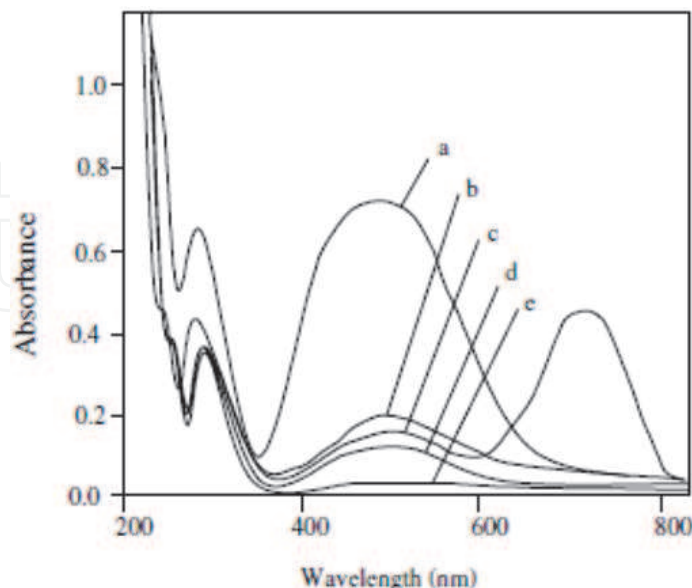

Fig. 8. Absorption spectra of  $5 \times 10^{-5} \text{ M}$  AcSHA and  $\text{M}-(\text{AcSHA})_n$  complexes. a)  $\text{Fe(III)}-(\text{AcSHA})_n$ ; b)  $\text{Fe(II)}-(\text{AcSHA})_n$ ; c)  $\text{Cu}-(\text{AcSHA})_n$ ; d)  $\text{M}-(\text{AcSHA})_n$ ; (M: Ni, Co, Zn, Pb); e) AcSHA only.

As can be seen from Fig. 8, only AcSHA reacted efficiently with iron to form iron-(AcSHA) $_n$  complexes with the absorbance maxima at 475 nm. At this wavelength, AcSHA itself has no absorption while Ac-SHA complexes of copper(II), nickel(II), cobalt(II), and zinc(II), among all metal ions with the anions tested, show a negligible absorption. The FIA setup shown in Fig. 9. was used in order to develop an FIA method based on the above phenomenon.

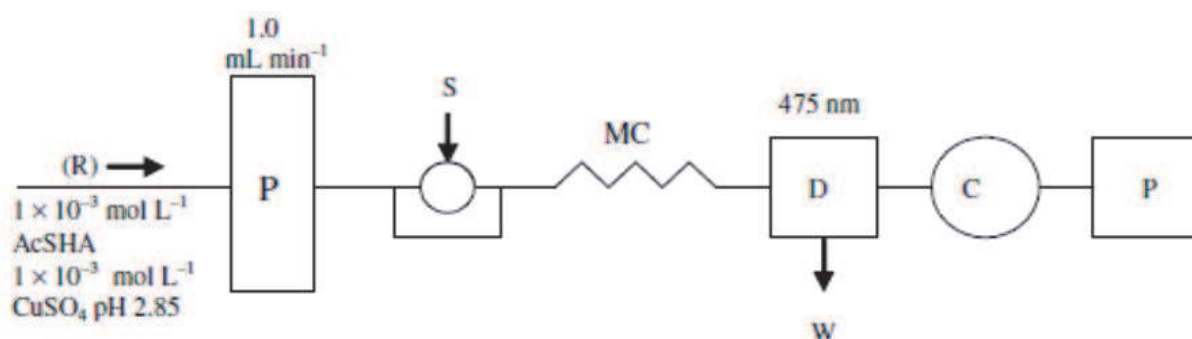

Fig. 9. Flow diagram of the flow-injection analysis system used for the determination of iron (III) and total iron, R; reagent carrier solution ( $1 \times 10^{-4}$  M AcSHA,  $1 \times 10^{-4}$  M  $\text{CuSO}_4$ , pH: 2.85), P, Peristaltic pump, S; Rheodyne sample injection valve, MC; mixing coil (50 cm long, 0.5 mm i.d), D; spectrophotometric detector ( $\lambda_{\text{max}} = 475$  nm), W; waste, C; computer, P; printer.

### 5.2.2 Optimisation of chemical variables and FIA manifold

Various variables closely related to iron determination were examined using a simple flow-injection analysis system with a fixed iron(III) concentration of  $5 \mu\text{g L}^{-1}$ . The AcSHA concentration was varied from  $1 \times 10^{-5}$  mol  $\text{L}^{-1}$  to  $1 \times 10^{-2}$  mol  $\text{L}^{-1}$ . The peak height was found to increase with the AcSHA concentration increasing up to  $1 \times 10^{-4}$  mol  $\text{L}^{-1}$ , no noticeable increase was found at higher concentrations. Therefore,  $1 \times 10^{-4}$  mol  $\text{L}^{-1}$  AcSHA was used as the colour developing component of the carrier solution. With the concentration of AcSHA fixed at  $1 \times 10^{-4}$  mol  $\text{L}^{-1}$ , pH of the carrier solution was varied from 1.5 to 5.5. The interference effect of iron(II) was found to increase with pH increasing up to 3.5 and to remain constant at higher pH. Also, the peak heights were found to increase with pH increasing up to 3.0, to remain constant up to 4.0, and to decrease slightly above this value. pH of the reagent carrier was, however, adjusted to 2.85 to obtain the maximum peak height and minimum iron(II) interference in the analysis. To obtain a reasonable background of absorption and a smooth baseline,  $\text{CuSO}_4$  was added into the carrier solution. The  $\text{CuSO}_4$  concentration was varied from  $1 \times 10^{-5}$  mol  $\text{L}^{-1}$  to  $1 \times 10^{-2}$  mol  $\text{L}^{-1}$ . When the concentration of  $\text{CuSO}_4$  was  $1 \times 10^{-4}$  mol  $\text{L}^{-1}$ , the baseline was stable and the interference effects of nickel(II), cobalt(II), and zinc(II) were found minimum. Over the  $\text{CuSO}_4$  concentration of  $1 \times 10^{-4}$  mol  $\text{L}^{-1}$ , the sensitivity of the method decreased.

In order to proceed with the final system design, the effects of sample volume, mixing coil length and flow-rate were studied at the optimal pH (2.85), and fixed concentrations of AcSHA ( $1 \times 10^{-4}$  mol  $\text{L}^{-1}$ ) and  $\text{CuSO}_4$  ( $1 \times 10^{-4}$  mol  $\text{L}^{-1}$ ). The sample volume was varied from 5–50  $\mu\text{L}$ . The peak height was decreased by decreasing the sample size, and the peaks were broadened with the increasing sample size due to the sample zone dispersion. The sample injection volume of 20  $\mu\text{L}$  was selected as a compromise between the sensitivity and sample throughput rate. The mixing coil (MC) was examined using PTFE tubing (0.5 mm i.d.) of

different lengths ranging between 10 cm and 150 cm. The peak height increased with the increasing mixing coil length from 10-50 cm, decreased at lower concentrations and broadened at higher concentrations and longer coil lengths. The mixing coil length of 50 cm was chosen since it resulted in the best peak height and good reproducibility.

The flow-rate was varied from 0.2 mL min<sup>-1</sup> to 2 mL min<sup>-1</sup>. The peak height decreased with the increasing flow-rate, probably due to the extent of the reaction decrease. The flow-rate of 0.8 mL min<sup>-1</sup> was selected as a compromise between the sample throughput rate and sensitivity. A linear calibration graph for 4-150 µg L<sup>-1</sup> iron(III), with the regression coefficient of 0.9914, was obtained under optimum conditions. The relative standard deviation for the determination of 5 µg L<sup>-1</sup> iron(III) was 0.85 % (10 replicate injections), RSD of the data was below 3 %. The limit of detection (blank signal plus three times the standard deviation of the blank) was 0.5 µg L<sup>-1</sup>. The sample throughput of the proposed method was almost 60 h<sup>-1</sup>.

Tolerance limit (µg L <sup>-1</sup> )	Foreign ion
Over 50000	Cr(III), Al(III), Cd(II), Mn(II), K(I), Na(I), Ag(I), Ca(II), Mg(II), Ba(II), Hg(II), CN <sup>-</sup> , NO <sub>3</sub> <sup>-</sup> , NO <sub>2</sub> <sup>-</sup> , SO <sub>4</sub> <sup>2-</sup> , CO <sub>3</sub> <sup>2-</sup> , Cl <sup>-</sup> , Br <sup>-</sup> , PO <sub>4</sub> <sup>3-</sup> , NH <sub>4</sub> <sup>+</sup>
Over 100	Fe (II)

Table 8. Effect of foreign ions on the determination of 5 µg L<sup>-1</sup> of iron (III) in solution

The interference effects of many cations and anions on the determination of 5 µg L<sup>-1</sup> iron(III) were examined. The results summarised in Table 8 represent tolerable concentrations of each diverse ion taken as the highest concentration causing an error of 3 %. Most of the ions examined did not interfere with the determination of iron(III). The major interference was caused by iron(II) at the amount of 100 µg L<sup>-1</sup>. It is known that zinc and cobalt are the main interference metal ions in the determination of iron (Ensafi et al., 2004). In this study, the interference of these ions was completely eliminated by an addition of copper sulphate (1×10<sup>-4</sup> mol L<sup>-1</sup>) to the reagent carrier solution. Background absorbance of copper(II) maintained in the reagent carrier solution eliminated possible interfering ions and improved the determination of iron(III). It is apparent from Table 1 that the proposed method tolerates all interfering species tested in satisfactory amounts, and it is therefore adequately selective for the determination of iron(III) and total iron.

### 5.2.3 Applications

The FIA method was applied in the determination of iron(III) and total iron in water and ore samples. In order to evaluate the accuracy of the proposed method, the determination of total iron in a standard reference material (Zn/Al/Cu 43XZ3F) and in a metal alloy sample was carried out. The analytical results obtained by the proposed method are in good agreement with the certified values as shown in Table 9.

For the application of the proposed FIA method to water samples; river and sea water samples collected from different sources were analysed using both the calibration curve and the standard addition methods. The values obtained from the calibration curve and the standard addition methods are in good agreement as shown in Table 10. Atomic absorption

measurements taken in water samples are also given for comparison (Table 10). The analytical value of total iron in water is in good agreement with that obtained by the AAS method.

Sample	Total Fe <sup>(1)</sup> (%)	Certified Fe (%)
Alloy (1)	8.23(0.24)	8.58
Alloy (2)	16.15(0.17)	16.62
Std Zn/Al/Cu 43XZ3 F	0.083(0.022)	0.085

<sup>(1)</sup> Values in parenthesis are the relative standard deviations for n=5 with confidence level of 95 %.

Table 9. Total iron content of iron alloys and standard reference material

Samples(1)	Iron (III)(2) (µg L <sup>-1</sup> )		Total iron(2) (µg L <sup>-1</sup> )		
	Found(3)	Found(4)	Found(3)	Found(4)	AAS
Kurtun river	38.33(0.24)	38.55(0.12)	42.33(0.02)	42.91(0.18)	43.65(0.17)
Seaport	78.84(0.32)	78.65(0.24)	95.13(0.12)	95.75(0.06)	97.12(0.12)
Baruthane sea water	47.51(0.18)	47.62(0.14)	57.24(0.04)	57.65(0.15)	58.97(0.24)

<sup>(1)</sup> Samples were collected at Samsun, Turkey.

<sup>(2)</sup> Values in parenthesis are the relative standard deviations for n=5 with confidence level of 95 %.

<sup>(3)</sup> Calibration curve method.

<sup>(4)</sup> Standard addition method.

Table 10. Determination of iron (III) and total iron in river and sea water samples

The results obtained show that the proposed method can be applied in the determination of iron(III) and total iron content in water samples without a preconcentration process.

## 6. Conclusions

A number of highly sensitive, selective and rapid flow-injection spectrophotometric and spectrofluorimetric analysis methods for the determination of iron (II), iron (III) and total iron in a wide concentration range, without employing any further treatment, have been described. The methods were based on the reactions of iron (II) and iron (III) with different complexing agents in different carrier solutions in FIA. In addition to the simplicity and low reagent consumption of the methods, the complexing agents used are commercially available and may not have a risk of serious toxicity, thus enhancing the potential applicability of the methods for iron analysis in real samples. Several parameters affecting to the determination of iron (II) and iron (III) were examined. The methods developed have been successfully applied to the determination of iron (II), iron (III) and total iron different types of water samples including river, sea, industry and spring water samples. The methods were also verified by applying certified reference materials.

## 7. References

- Ahmed M. J. and Roy U. K. (2009) A simple spectrophotometric method for the determination of iron(II) aqueous solutions. Turkish journal of chemistry. 33, 709-726



- Alonso J., Bartroli J., Valle M. D. and Barber R. (1989) Sandwich techniques in flow-injection analysis Part 2. Simultaneous determination of iron(II) and total iron. *Analytica Chimica Acta*, 219, 345-350.
- Ampan P., Lapanantnoppakhum S., Sooksamiti P., Jakmunee J., Hartwell S. K., Jayasvati S., Christian G. D. and Grudpan K. (2002) Determination of trace iron in beer using flow-injection systems with in-valve column and bead injection. *Talanta*, 58, 1327-1334.
- Andac M., Asan A. and Isildak I. (2001) Flow-injection spectrophotometric determination of cobalt(II) at low  $\mu\text{g l}^{-1}$  levels with 4-benzylpiperidinedithiocarbamate. *Analytica Chimica Acta*, 434, 143-147.
- Andac M., Asan A. and Isildak I. (2009) A simple flow injection spectrophotometric determination method for iron(III) based on O-acetylsalicylhydroxamic acid complexation. *Chemical Papers*, 63, 268-273
- Araujo A. N., Gracia J., Lima J. L. F. C., Poch M., Luica M. and Saraiva M. F. S. (1997) Colorimetric determination of iron in infant fortified formulas by sequential injection analysis. *Fresenius' Journal of Analytical Chemistry*, 357, 1153-1156.
- Asan A., Andac M. and Isildak I. (2010) Flow injection spectrofluorimetric determination of iron(III) in water using salicylic acid. *Chemical Papers*, 64(4) 424-428.
- Asan A., Andac M., Isildak I. and Tinkilic N. (2008) Flow Injection Spectrophotometric Determination of Iron(III) Using Diphenylamine-4-sulfonic Acid Sodium Salt. *Chemical Papers*, 62 (4), 345-349.
- Asan A., Andac M. and Isildak I. (2003) Flow-injection spectrophotometric determination of nanogram levels of iron(III) with N,N-dimethylformamide. *Anal. Sci.*, 19 (7), 1033-1036.
- Asan A., Isildak I., Andac M. and Yilmaz F. (2003) A simple and selective flow-injection spectrophotometric determination of copper(II) by using acetylsalicylhydroxamic acid. *Talanta*, 60, 861-866.
- Bagheri H., Gholami A. and Najafi A. (2000) Simultaneous preconcentration and speciation of iron(II) and iron(III) in water samples by 2-mercaptobenzimidazole-silica gel sorbent and flow injection analysis system. *Analytica Chimica Acta*, 424, 233-242.
- Bruno H. A., Andrade F. J., Luna P. C. and Tudino M. B. (2002) Kinetic control of reagent dissolution for the flow injection determination of iron at trace levels. *Analyst*, 127, 990-994.
- Busev A. I., Tiptsova V. G. and Ivanov V. M. (1981) *Anal. Chem. of rare elements*, 385.
- Cha K. W. and Park C. I. (1996) Spectrofluorimetric determination of iron(III) with 2-pyridinecarbaldehyde-5-nitropyridylhydrazone in the presence of hexadecyltrimethylammonium bromide surfactant. *Talanta*, 43, 1335-1341.
- Cha K. W. and Park K. W. (1998) Determination of iron(III) with salicylic acid by the fluorescence quenching method. *Talanta*, 46, 1567-1571.
- Chen J. Q., Gao W. and Song J. F. (2006) Flow-injection determination of iron(III) in soil by biamperometry using two independent redox couples. *Sensors and Actuators B*, 113,194-200.

- Bowie A. R., Achterberg E. P., Mantoura R. F. C. and Worsfold, P. J. (1998) Determination of sub-nanomolar levels of iron in seawater using flow injection with chemiluminescence detection. *Analytica Chimica Acta*, 36, 189–200.
- Currie L. A. (1995) Nomenclature in evaluation of analytical methods including detection and quantification capabilities. *Pure and Applied Chemistry*, 67, 1699–1723.
- Dojlido J. R. and Best G. A. (1993) *Chemistry of water and water pollution*. Chichester: Ellis Horwood series in water and wastewater technology. Prentice Hall Inc. Englewood Cliffs, 21: 251.
- Ensafi A. A., Chamjangali M. A. and Mansour H. R. (2004) Sequential determination of iron(II) and iron(III) in pharmaceutical by flow-injection analysis with spectrophotometric detection. *Analytical Sciences*, 20, 645–650.
- Giokas D. L., Paleologos E. K. and Karayannis M. I. (2002) Speciation of Fe(II) and Fe(III) by the modified ferrozine method, FIA-spectrophotometry, and flame AAS after cloudpoint extraction. *Analytical and Bioanalytical Chemistry*, 373, 237–243.
- Guo T. and Baasner J. (1993) Determination of mercury in urine by flow-injection cold vapour atomic absorption spectrometry. *Analytica Chimica Acta*, 278, 189–196.
- Hirata S., Yoshihara H. and Aihara M. (1999) Determination of iron(II) and total iron in environmental water samples by flow injection analysis with column preconcentration of chelating resin functionalized with Nhydroxyethylethylenediamine ligands and chemiluminescence detection. *Talanta*, 49, 1059–1067.
- Isildak I., Asan A. and Andac M. (1999) Spectrophotometric determination of copper(II) at low  $\mu\text{g l}^{-1}$  levels using cationexchange microcolumn in flow-injection. *Talanta*, 48, 219–224.
- Kawakubo S., Natio A., Fujihara A. and Iwatsuki M. (2004) Field determination of trace iron in fresh water samples by visual and spectrophotometric methods. *Analytical Sciences*, 20, 1159–1163.
- Kass M. and Ivaska A. (2002) Spectrophotometric determination of iron(III) and total iron by sequential injection analysis technique. *Talanta*, 58, 1131–1137.
- Lunvongsa S., Takayanagi T., Oshima M. and Motomizu S. (2006) Novel catalytic oxidative coupling reaction of N,N-dimethyl-p-phenylenediamine with 1,3-phenylenediamine and its applications to the determination of copper and iron at trace levels by flow injection technique. *Analytica Chimica Acta*, 576, 261–269.
- Lunvongsa S., Oshima M. and Motomizu S. (2006) Determination of total and dissolved amount of iron in water samples using catalytic spectrophotometric flow injection analysis. *Talanta*, 68, 969–973.
- MacCarthy P. and Zachary D. H. (1986) *Journal of Chemical Education* 63 (3): 162–167.
- Molina-Diaz A., Ortega-Carmona I. and Pascual-Reguera M.I. (1998) Indirect spectrophotometric determination of ascorbic acid with ferrozine by flow-injection analysis. *Talanta*, 47:531–536
- Mohammad R. S., Deepika J., Jonathan P. K. and Keith A. H. (2004) Determination of labile  $\text{Cu}^{2+}$  in fresh waters by chemiluminescence: interference by iron and other cations. *Talanta*, 62: 924–930

- Morelli B. (1983) Determination of iron(III) and copper(II) by zeroth, first and second derivative spectrophotometry with 2-thiobarbituric acid (4,6-dihydroxy-2-mercaptopyrimidine) as reagent. *Analyst*, 108, 870-879.
- Mulaudzi L. V., van Standen J. F. and Stefan R. J. (2002) On-line determination of iron(II) and iron(III) using a spectrophotometric sequential injection system. *Analytica Chimica Acta*, 467, 35-49.
- Muller H., Muller V. and Hansen E. H. (1990) Simultaneous differential rate determination of iron(II) and iron(III) by flow-injection analysis. *Analytica Chimica Acta*, 230, 113-123.
- O'Brien E. C., Roy S. L., Levailain J., Fitzgerald D. J. and Nolan K. B. (1997) Metal complexes of salicylhydroxamic acid and O-acetylsalicylhydroxamic acid. *Inorganica Chimica Acta*, 266, 117-120.
- Ohno S., Tanaka M., Teshima N. and Sakai T. (2004) Successive determination of copper and iron by a flow injection catalytic photometric method using a serial flow cell. *Analytical Sciences*, 20, 171-175.
- Qin W., Zhang Z. J. and Wang F. C. (1998) Chemiluminescence flow system for the determination of Fe(II) and Fe(III) in water. *Fresenius' Journal of Analytical Chemistry*, 360, 130-132.
- Pascual-Reguera M. I., Ortega-Carmona I. and Molina-Diaz A. (1997) Spectrophotometric determination of iron with ferrozine by flow-injection analysis. *Talanta*, 44, 1793-1801.
- Pojanagaron T., Watanesk S., Rattanaphani V. and Liawruangrath S. (2002) Reverse flow-injection spectrophotometric determination of iron(III) using norfloxacin. *Talanta*, 58, 1293-1300
- Pons C., Forteza R. and Cerdà V. (2005) Multi-pumping flow-system for the determination, solid-phase extraction and speciation analysis of iron. *Analytica Chimica Acta*, 550, 33-39.
- Pons C., Forteza R. and Cerdà V. (2005) The use of anion exchange disks in an optrode coupled to a multi-syringe flow injection system for the determination and speciation analysis of iron in natural water samples. *Talanta*, 66, 210-217.
- Pulido-Tofino P., Barrero-Moreno J. M. and Perez-Conde M. C. (2000) A flow-through fluorescent sensor to determine Fe(III) and total inorganic iron. *Talanta*, 51, 537-545.
- Ragos G. C., Demertzis M. A. and Issopoulos P. B. (1998) A high-sensitive spectrofluorimetric method for the determination of micromolar concentrations of iron(III) in bovine liver with 4-hydroxyquinoline. *II Farmaco*, 53, 611-616.
- Reguera M. I. P., Carmona I. O. and Diaz A. M. (1997) Spectrophotometric determination of iron with ferrozine by flow-injection analysis. *Talanta*, 44, 1793-1801.
- Saitoh K., Hasebe T., Teshima N., Kurihara M. and Kawashima T. (1998) Simultaneous flow-injection determination of iron(II) and total iron by micelle enhanced luminol chemiluminescence. *Analytica Chimica Acta*, 376, 247-254.
- Sangi M. R., Jayatissa D., Kim J. P. and Hunter K. A. (2004) Determination of labile Cu<sup>2+</sup> in fresh waters by chemiluminescence: interference by iron and other cations. *Talanta*, 62, 924-930.

- Sultan S. M., Suliman F. O., Duffuaa S. O. and Abu-Abdoun I. I. (1992) Simplex-optimized and flow injection spectrophotometric assay of tetracycline antibiotics in drug formulations. *Analyst*, 117, 1179-1183.
- Sultan S.M. and Suliman F.O. (1992) Flow-Injection spectrophotometric determination of the antibiotic ciprofloxacin in drug formulations. *Analyst*, 117: 1523-1526
- Tamm L. K.. and Kalb E. (1993) Microspectrofluorometry on supported planar membranes. In S. G. Schulman (Ed.), *Molecular luminescence spectroscopy. Methods and applications: Part 3* (pp. 303). New York, NY, USA: Wiley.
- Tarafder P. K. and Thakur R. (2005) Surfactant-mediated extraction of iron and its spectrophotometric determination in rocks, minerals, soils, stream sediments and water samples. *Microchemical Journal*, 80, 39-43.
- Teshima N., Ayukawa K.. and Kawashima T. (1996). Simultaneous flow injection determination of iron(III) and vanadium(V) and of iron(III) and chromium(VI) based on redox reactions. *Talanta*, 43, 1755-1760.
- Teixeira L. S. G. and Rocha F. R. P. (2007) A green analytical procedure for sensitive and selective determination of iron in water samples by flow-injection solid phase spectrophotometry. *Talanta*, 71, 1507-1511.
- Tesfaldet Z. O., van Standen J. F. and Stefan R. J. (2004) Sequential injection spectrophotometric determination of iron as Fe(II) in multi-vitamin preparations using 1,10-phenanthroline as complexing agent. *Talanta*, 64, 1189-1195.
- Themelis D. G., Tzanavaras P. D., Kika F. S. and Sofoniou M. C. (2001) Flow-injection manifold for the simultaneous spectrophotometric determination of Fe(II) and Fe(III) using 2,2'-dipyridyl-2-pyridylhydrazone and a single-line double injection approach. *Fresenius' Journal of Analytical Chemistry*, 371, 364-368.
- Udnan Y., Jakmune J., Jayasavati S., Christian G. S., Synovec R. E. and Grudpan K.. (2004). Cost-effective flow injection spectrophotometric assay of iron content in pharmaceutical preparations using salicylate reagent. *Talanta*, 64, 1237-1240.
- van Staden J. F. and Kluever L. G. (1998) Determination of total iron in ground waters and multivitamin tablets using a solid-phase reactor with iron immobilised on amberlite ion-exchange resin in a flow injection system. *Fresenius' Journal of Analytical Chemistry*, 362, 319-323.
- Weeks D. A. and Bruland K. W. (2002) Improved method for shipboard determination of iron in seawater by flow injection analysis. *Analytica Chimica Acta*, 453, 21-32.
- Wirat R. (2008) Reverse flow injection spectrophotometric determination of iron(III) using chlortetracycline reagent. *Talanta*, 74, 1236-1241.
- Yamamura S. S. and Sikes J. H. (1966) Use of citrate-EDTA masking for selective determination of iron with 1,10-phenanthroline. *Analytical Chemistry*, 38, 793-795.
- Yan G. F., Shi G. R. and Liu Y. M. (1992) Fluorimetric determination of iron with 5-(4-methylphenylazo)-8- aminoquinoline in the presence of surfactants. *Analytica Chimica Acta*, 264, 121-124.

- Yegorov D. Y., Kozlov A. V., Azizova O. A. and Vladimirov Y. A. (1993) Simultaneous determination of Fe(III) and Fe(II) in water solutions and tissue homogenates using desferal and 1,10-phenanthroline. *Free Radical Biology & Medicine*, 15, 565-574.
- Yilmaz V. T. and Yilmaz F. (1999) Acetylsalicylhydroxamic acid and its cobalt(II), nickel(II), copper(II) and zinc(II) complexes. *Transition Metal Chem.*, 24, 726-729.

IntechOpen

IntechOpen

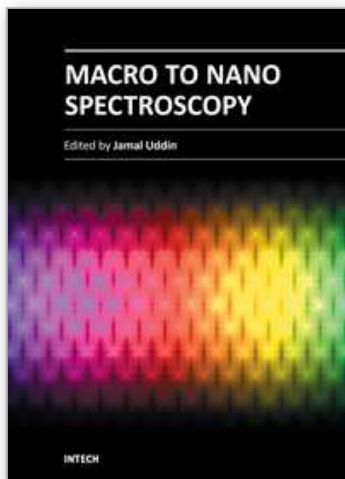

## **Macro To Nano Spectroscopy**

Edited by Dr. Jamal Uddin

ISBN 978-953-51-0664-7

Hard cover, 448 pages

**Publisher** InTech

**Published online** 29, June, 2012

**Published in print edition** June, 2012

In the last few decades, Spectroscopy and its application dramatically diverted science in the direction of brand new era. This book reports on recent progress in spectroscopic technologies, theory and applications of advanced spectroscopy. In this book, we (INTECH publisher, editor and authors) have invested a lot of effort to include 20 most advanced spectroscopy chapters. We would like to invite all spectroscopy scientists to read and share the knowledge and contents of this book. The textbook is written by international scientists with expertise in Chemistry, Biochemistry, Physics, Biology and Nanotechnology many of which are active in research. We hope that the textbook will enhance the knowledge of scientists in the complexities of some spectroscopic approaches; it will stimulate both professionals and students to dedicate part of their future research in understanding relevant mechanisms and applications of chemistry, physics and material sciences.

### **How to reference**

In order to correctly reference this scholarly work, feel free to copy and paste the following:

Ibrahim Isildak (2012). Flow-Injection Spectrophotometric Analysis of Iron (II), Iron (III) and Total Iron, Macro To Nano Spectroscopy, Dr. Jamal Uddin (Ed.), ISBN: 978-953-51-0664-7, InTech, Available from: <http://www.intechopen.com/books/macro-to-nano-spectroscopy/flow-injection-spectrophotometric-analysis-of-iron-ii-iron-iii-and-total-iron>

**INTECH**  
open science | open minds

### **InTech Europe**

University Campus STeP Ri  
Slavka Krautzeka 83/A  
51000 Rijeka, Croatia  
Phone: +385 (51) 770 447  
Fax: +385 (51) 686 166  
[www.intechopen.com](http://www.intechopen.com)

### **InTech China**

Unit 405, Office Block, Hotel Equatorial Shanghai  
No.65, Yan An Road (West), Shanghai, 200040, China  
中国上海市延安西路65号上海国际贵都大饭店办公楼405单元  
Phone: +86-21-62489820  
Fax: +86-21-62489821

© 2012 The Author(s). Licensee IntechOpen. This is an open access article distributed under the terms of the [Creative Commons Attribution 3.0 License](#), which permits unrestricted use, distribution, and reproduction in any medium, provided the original work is properly cited.

IntechOpen

IntechOpen