

We are IntechOpen, the world's leading publisher of Open Access books Built by scientists, for scientists

4,800

Open access books available

122,000

International authors and editors

135M

Downloads

Our authors are among the

154

Countries delivered to

TOP 1%

most cited scientists

12.2%

Contributors from top 500 universities



WEB OF SCIENCE™

Selection of our books indexed in the Book Citation Index
in Web of Science™ Core Collection (BKCI)

Interested in publishing with us?
Contact book.department@intechopen.com

Numbers displayed above are based on latest data collected.

For more information visit www.intechopen.com



Cellular Iron Metabolism – The IRP/IRE Regulatory Network

Ricky S. Joshi, Erica Morán and Mayka Sánchez
*Institute of Predictive and Personalized Medicine of Cancer (IMPPC),
Badalona, Barcelona,
Spain*

1. Introduction

General Overview of iron homeostasis

Iron is the most abundant transition metal in cellular systems and is an essential micronutrient required for many cellular processes including DNA synthesis, oxidative cell metabolism, haemoglobin synthesis and cell respiration. Despite iron being an absolute requirement for almost all organisms, caution should be taken with an inappropriate disequilibrium in iron levels because excess iron is toxic and a lack of it leads to anaemia.

As a transition metal, iron can exist in various oxidation states (from -2 to +6). Usually, iron exists and switches between two different ionic states (Fe^{+2} and Fe^{+3}). Iron in the reduced state is known as ferrous iron and has a net positive charge of two (Fe^{+2}). In the oxidized state it is known as ferric iron and has a net positive charge of three (Fe^{+3}). This electron switch property of iron as a metal element allows it to be used as a cofactor by many enzymes involved in oxidation-reduction reactions and also confers its toxicity. Iron toxicity relates to the intracellular labile iron pool (LIP), a pool of transitory, chelatable (i.e. free) and redox-active iron that can catalyze the formation of oxygen-derived free radicals via the Fenton reaction. Iron-catalyzed oxidative stress causes lipid peroxidation, protein modifications, DNA damage (promoting mutagenesis) and depletion of antioxidant defences.

Iron containing proteins can be classified into 3 groups (for an extensive revision see (Crichton, 2009)):

Haemoproteins, in which iron is bound to four ring nitrogen atoms of a porphyrin molecule called haem and one or two axial ligands from the protein. Examples of haemoproteins are the oxygen transport protein haemoglobin, the muscle oxygen storage protein myoglobin, peroxidases, catalases and electron transport proteins such as the cytochromes a, b and c.

Iron-sulphur proteins are proteins that contain iron atoms bound to sulphur forming a cluster linked to the polypeptide chain by thiol groups of cysteine residues or to non-protein structures by inorganic sulphide and cysteine thiols. Examples of iron-sulphur proteins are the ferredoxins, hydrogenases, nitrogenases, NADH dehydrogenases and aconitases.

Non-haem non iron-sulphur proteins, these proteins can be of three types:

Mononuclear non-haem iron enzymes such as catechol or Rieske dioxygenases, alpha-keto acid dependent enzymes, pterin-dependent hydrolases, lipoxygenases and bacterial superoxide dismutases

Dinuclear non-haem iron enzymes, also known as diiron proteins, like the H-ferritin chain, haemerythrins, ribonucleotide reductase R2 subunit, stearyl-CoA desaturases and bacterial monooxygenases

Proteins involved in ferric iron transport, for instance the transferrin family that includes serotransferrin, lactotransferrin, ovotransferrin and melanotransferrin and are found in physiological fluids of many vertebrates.

As previously mentioned, many proteins involved in very different cellular pathways contain iron. Therefore, cells require iron to function properly. However, mammals have no physiological excretion mechanisms to release an excess of iron and consequently, iron homeostasis must be tightly controlled on both the systemic and cellular levels to provide just the right amounts of iron at all times. If an adequate balance of iron is not achieved, it will cause a clinical disorder. Iron is therefore crucial for health. Iron deficiency leads to anaemia –a major world-wide public health problem– and iron overload is toxic and increases the oxidative stress of body tissues leading to inflammation, cell death, system organ dysfunction, and cancer (Hentze et al., 2010).

Systemic iron homeostasis is regulated by the hepcidin/ferroportin system in vertebrates (Ganz & Nemeth, 2011). Hepcidin is a liver-specific hormone secreted in response to iron loading and inflammation and is the master regulator of systemic iron homeostasis. Increased hepcidin levels result in anaemia while decreased expression is a causative feature in most primary iron overload diseases. Transcription of hepcidin in hepatocytes is regulated by a variety of stimuli including cytokines (TNF- α , IL-6), erythropoiesis, iron stores and hypoxia (De Domenico et al., 2007). At the molecular level, the binding of hepcidin to the iron exporter ferroportin (FPN) induces its internalization and degradation; and thus prevents iron entry into plasma (Nemeth et al., 2004).

Cellular iron homeostasis is mainly controlled by a system composed of RNA binding proteins and RNA binding elements that constitutes a post-transcriptional gene expression regulation system known as the Iron Regulatory Protein (IRP) / Iron-Responsive Element (IRE) regulatory network (Hentze et al., 2010; Muckenthaler et al., 2008; Recalcati et al., 2010). This chapter will focus on the IRP/IRE regulatory network, addressing in depth, its role in the regulation of cellular iron homeostasis, its alterations in diseases and new research lines to be explored in the future.

2. Cellular iron homeostasis

Cellular iron maintenance involves the coordination of iron uptake, utilization, and storage to ensure appropriate levels of iron inside the cell. Although transcriptional regulation of iron metabolism has been reported in the literature; cellular iron homeostasis is mainly controlled at the post-transcriptional level (Muckenthaler et al., 2008). In general, post-transcriptional regulation ensures a faster and easier way of controlling protein expression levels in mammals by changing the rate of specific mRNA synthesis using repressor or

stabilizer proteins. Particularly in iron metabolism, this system involves the so-called IRP/IRE regulatory network.

2.1 The IRP/IRE regulatory network

The Iron Regulatory Protein (IRP) / Iron-Responsive Element (IRE) regulatory network is a post-transcriptional gene expression regulation system that controls cellular iron homeostasis. This network comprises two RNA binding proteins called Iron Regulatory Proteins (IRP1 and IRP2) and *cis*-regulatory RNA elements, named Iron-Responsive Elements, or IRE, that are present in mRNAs encoding for important proteins of iron homeostasis.

IRP/IRE interactions regulate the expression of the mRNAs encoding proteins for iron acquisition (transferrin receptor 1, TFR1; divalent metal transporter 1, Slc11a2), iron storage (H-ferritin, Fth1; L-ferritin, Ftl), iron utilization (erythroid 5-aminolevulinic acid synthase, Alas2), energy (mitochondrial aconitase, Aco2; *Drosophila* succinate dehydrogenase, Sdh), and iron export (ferroportin, Fpn-Slc40a1) (Figure 1) (Muckenthaler et al., 2008). Less well known is the role of the IRP/IRE regulatory network in the control of other pathways (for details see section 2.1.3.5).

The IRE binding activities of IRP1 and IRP2 are regulated by intracellular iron levels and other stimuli (including nitric oxide, oxidative stress, and hypoxia) through distinct mechanisms (for details see sections 2.1.2.1 and 2.1.2.2). IRP/IRE binding activity is high in iron-deficient cells and low in iron-replete cells. When iron levels inside the cells are increased the IRPs are unable to bind the IREs, because IRP1 in these conditions assemble an iron-sulphur cluster (Fe-S cluster) and it is transformed into a cytosolic aconitase; while IRP2 is degraded by a mechanism that involves the proteasome (see section 2.1.2.1). Therefore, only in iron-starved cells, the IRPs became an IRE binding protein (Figure 1).

Depending on the location of the IRE in the untranslated regions (UTR), IRP binding regulates gene expression differentially. Both IRPs inhibit translation initiation when bound to IREs at the 5'UTR by preventing the recruitment of the small ribosomal subunit to the mRNA (Muckenthaler et al., 1998). Although the cap binding complex eIF4F can assemble when IRP1 is bound to a cap-proximal IRE, the small ribosomal subunit cannot be established in the presence of IRP1, which interferes with the bridging interactions that need to be established between eIF4F and the small ribosomal subunit. The IRPs association with the 3'IREs of the TRF1 mRNA decreases its turnover by preventing an endonucleolytic cleavage and its mRNA degradation (Binder et al., 1994). This mechanism of IRP mRNA stabilization has not been fully probed for other 3' IRE-containing mRNAs such as DMT1 and CDC14A, which only have a single 3'IRE and may require additional factors for their regulation. Overall, the regulation of the IRE-binding activities of IRP1 and IRP2 assures the appropriate expression of IRP target mRNAs and cellular iron balance.

The IRP/IRE regulatory system was initially described as a simple post-transcriptional regulatory gene expression circuit controlling the production of the ferritins and Transferrin Receptor 1. The identification of other mRNAs associated with this system has added considerable complexity and has extended the role of the IRPs to interconnect different cellular pathways, which should be regulated by iron metabolism in a coordinated way.

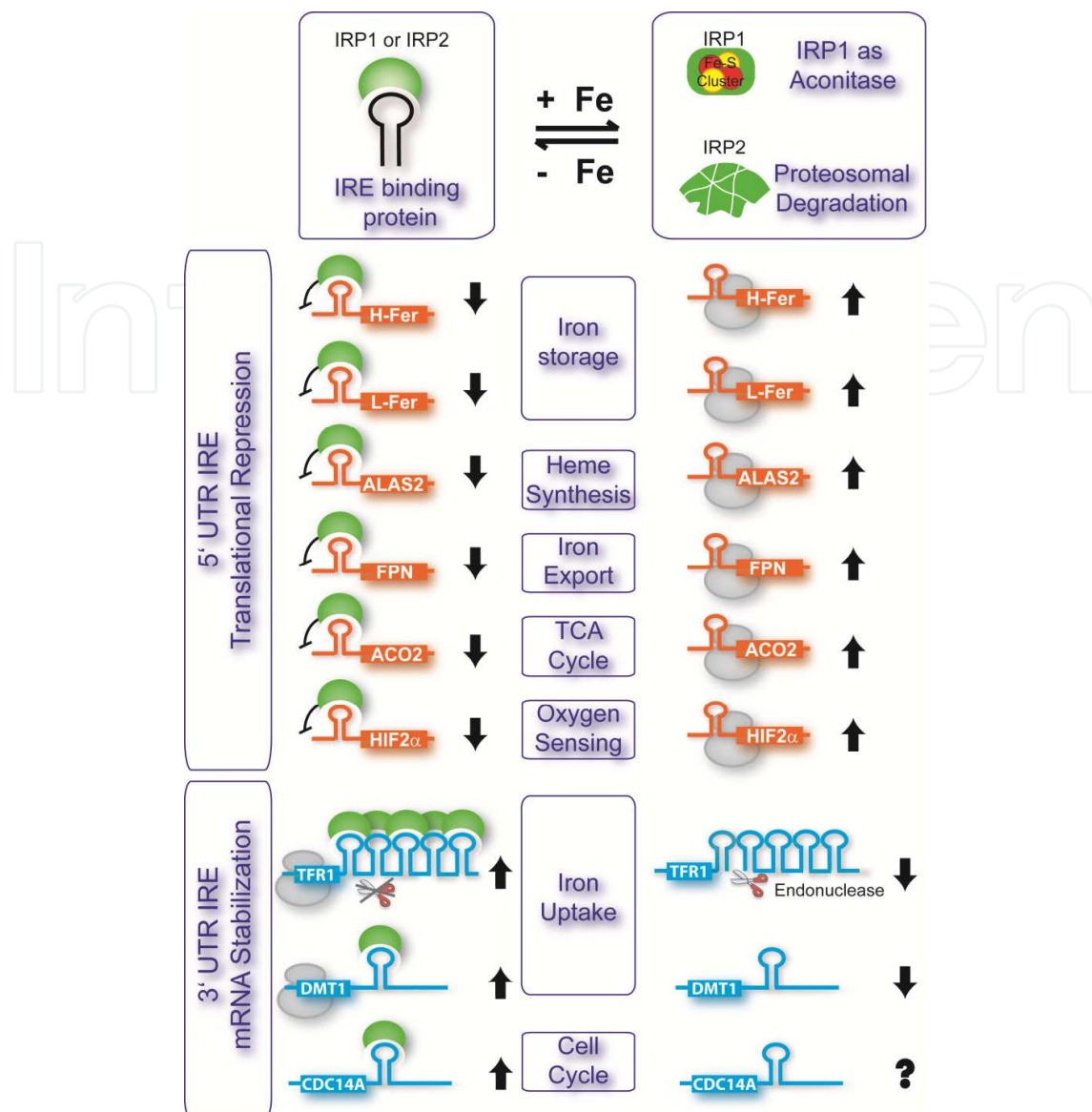

Fig. 1. The iron-regulatory protein/iron-responsive element (IRP/IRE) regulatory system. IRP1 and IRP2 bind to IREs in iron-deficient conditions (-Fe). This binding mediates translation repression in those mRNAs with an IRE at the 5' UTR, decreasing their protein levels. If the IRE is in the 3' UTR the IRP binding enhances mRNA stabilization by preventing an endonucleotic cleavage in TFR1 mRNA. The exact mechanism of IRP regulation in DMT1 and CDC14A mRNA is not yet well known. H-Fer: H-ferritin, L-Fer: L-ferritin, ALAS2: erythroid-specific delta-aminolevulinatase synthase, FPN: Ferroportin, ACO2: mitochondrial aconitase 2, HIF2 α : Hypoxia inducible factor 2 alpha, TFR1: Transferrin Receptor 1, DMT1: divalent metal transporter 1, CDC14A: Cell Division Cycle 14, *S. Cerevisiae*, homolog A.

2.1.1 Iron-Responsive Elements (IRE)

Iron-responsive elements or IREs are conserved *cis*-regulatory mRNA motifs of 25-30 nucleotides located in the untranslated regions (UTR) of mRNAs that encode proteins involved in iron metabolism.

The mRNAs of H-ferritin (FTH1), L-ferritin (FTL), erythroid-specific delta-aminolevulinate synthase (ALAS2), ferroportin (FPN), mitochondrial aconitase 2 (ACO2), and others (see section 2.1.3.5) contain one single IRE in their 5'UTRs (Figure 1 and 2). The mRNA encoding for Transferrin Receptor 1 (TFR1) is so far the only known mRNA with multiple (five) IREs, all of them located in its 3'UTR. The mRNA encoding for DMT1 protein (gene SLC11A2) also contains a single IRE in its 3'UTR (Figure 1 and 2). In addition, a single 3' IRE has been reported in other not so well documented mRNAs (see section 2.1.3.5).

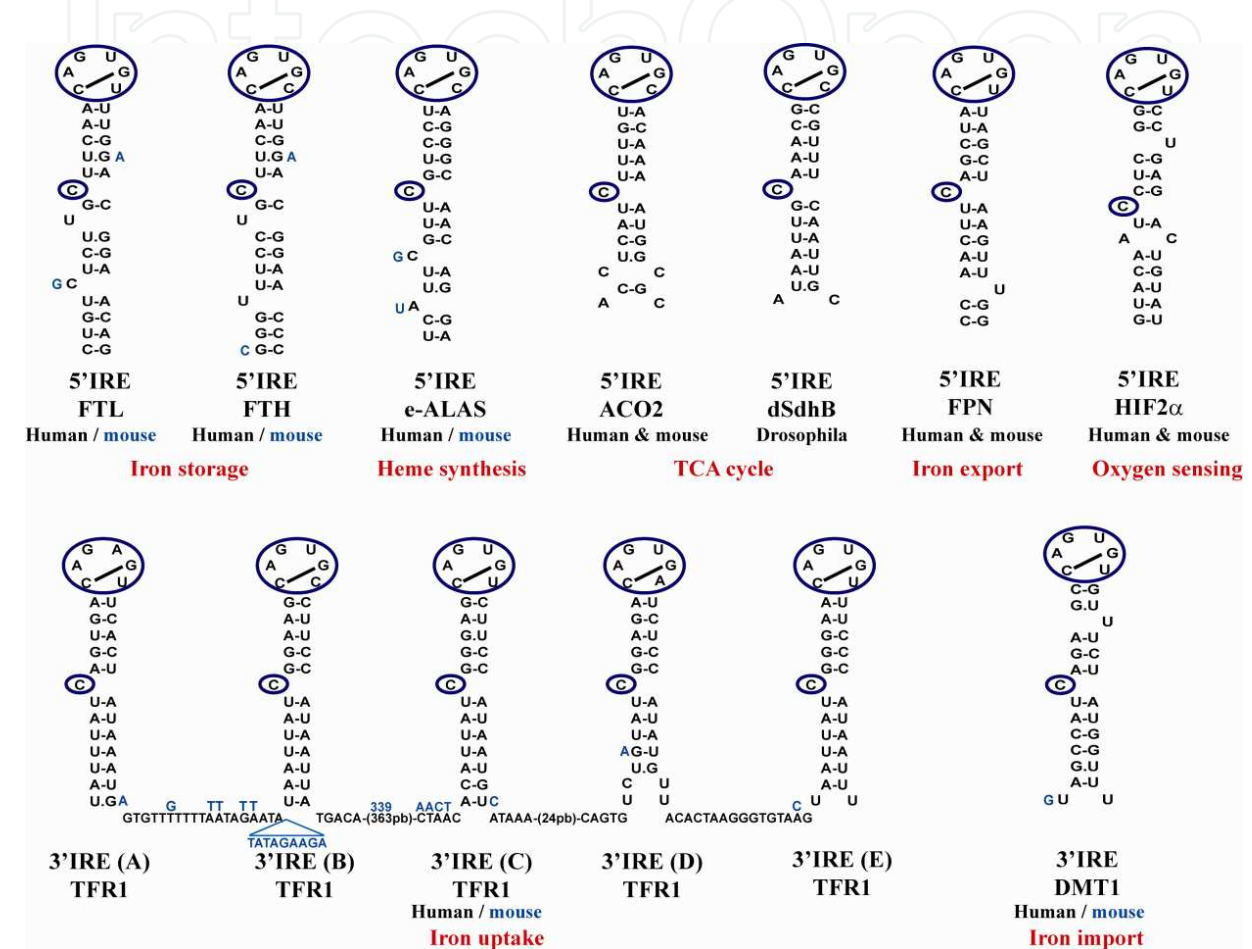

Fig. 2. Functional Iron-Responsive Elements (IREs) and the role of their encoded protein. Note all motifs contain the characteristic C-bulge (C8) present in the stem motif and a 6-nucleotide – CAGAGU/C- apical loop both circled in blue. 5' IREs are shown at the top of the figure and 3' IREs at the bottom. The 5 IREs from TFR1 mRNAs are depicted and named as IRE-A to IRE-E. Nucleotides shown in blue represent changes in mouse with respect to the human sequence. The function of the encoded protein is shown in red. FTL: L-Ferritin, FTH:H- Ferritin, e-ALAS2: erythroid-specific delta-aminolevulinate synthase, ACO2: mitochondrial aconitase 2, dSdhB: Drosophila succinate dehydrogenase B, FPN: Ferroportin, HIF2 α : Hypoxia inducible factor 2 alpha, TFR1: Transferrin Receptor 1, DMT1: divalent metal transporter 1.

The canonical IRE hairpin-loop is composed of a six-nucleotide apical loop (5'-CAGWGH-3'; whereby W stands for A or U and H for A, C or U) on a stem of five paired nucleotides, a small asymmetrical bulge with an unpaired cytosine on the 5' strand of the stem, and an additional lower stem of variable length (see Figure 2 for IREs examples). The IRE stem

forms base pairs of moderate stability, and folds into an α -helix (Figure 3B) distorted by the presence of a small 5' bulge (an unpaired C8 nucleotide) in the middle of the IRE. IRE base pairs can be Watson-Crick bonding or wobble pairs (U.G or G.U). The IRE (CAGWGH) terminal loop forms a pseudotri-loop (AGW) isolated by a conserved base pair (C14:G18) and followed by an unpaired nucleotide (N19, Figure 3A). The base pair C14:G18 and the unpaired nucleotide do not make contact with the protein, which suggests that the bridge C14:G18 serves only a structural role for IRP1 recognition (Walden et al., 2006). The pseudotri-loop and the C8 nucleotide make multiple contacts with IRP1 (for more details see section 2.1.2.1). It is most likely that all these important structural details, revealed in the 2.8 angstrom resolution crystal structure of the IRP1:H-ferritin IRE complex reported by Walden and collaborators, also apply to IRP2:IRE structures (Walden et al., 2006).

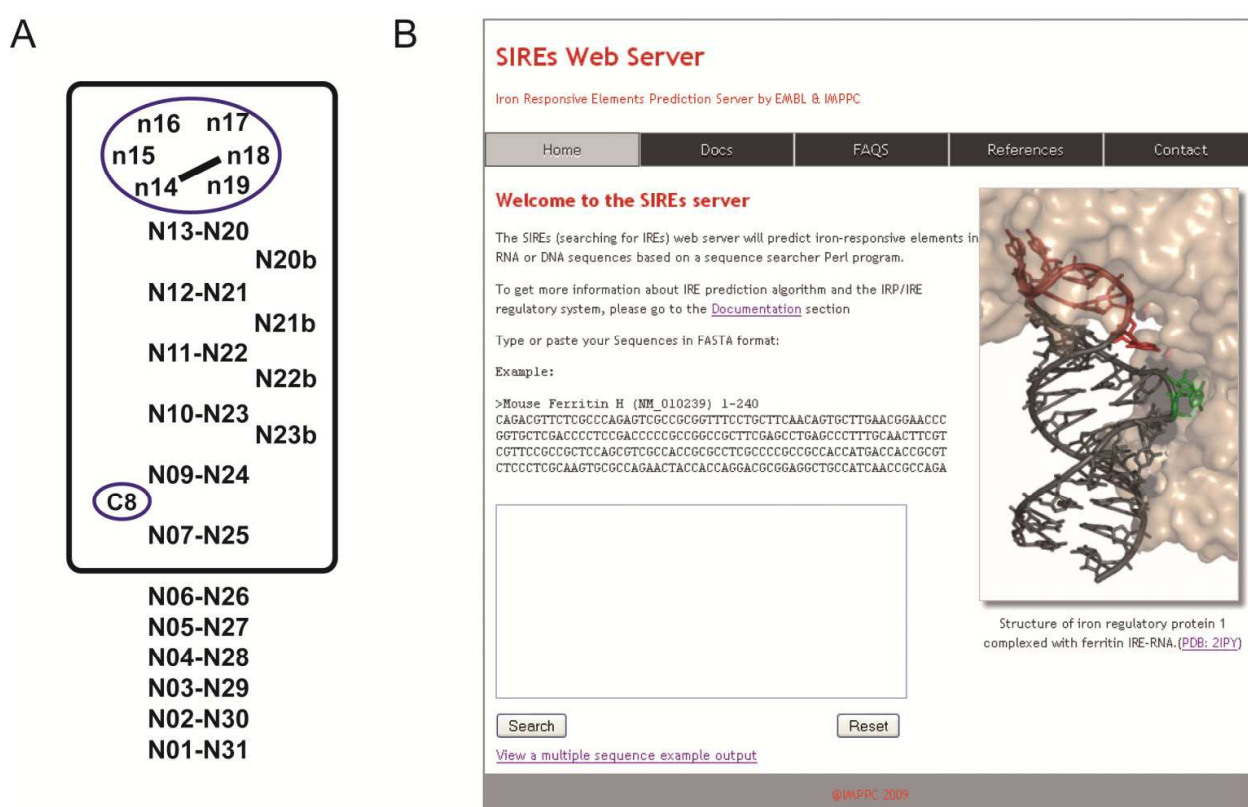

Fig. 3. SIREs, Searching for Iron-Responsive Elements, the bioinformatic program for the prediction of IREs. A. Schematic representation of an IRE motif, rectangular region indicates the IRE core region predicted by SIREs software. C-bulge (C8) and 6 nucleotide apical loop are shown within a blue circle. The presence of possible 3' bulge nucleotides are represented as N20b, N21b, N22b and N23b. B. SIREs freely available web-server home page at <http://ccb.g.imppc.org/sires/index.html>.

The differential regulation of the IRPs on the different 5' and 3' IREs is discussed in the section above. Mutations in the Iron-Responsive Elements disrupt the IRP/IRE regulatory system and cause iron-related disorders in humans (for details see sections 3).

2.1.1.1 Bioinformatic predictions of iron-responsive elements

One of the biggest challenges facing researchers in the study of IREs is the availability of fast, reliable approaches to recognising possible IREs in known RNA sequences. Existing software tools to predict this type of *cis*-regulatory element (RNA Analyzer, UTRScan and RNAMotif) (Bengert & Dandekar, 2003; Macke et al., 2001; Mignone et al., 2005) are not sufficiently accurate to find atypical IREs due to their strict constraints for pattern matching searches. Therefore, these programs fail to identify mRNAs that have an atypical IRE with an unpaired 3' bulged nucleotide in the upper stem, such as the HIF2 α IRE (see Figure 2). In addition, previous SELEX (systematic evolution of ligands by exponential enrichment) experiments have reported that the six-nucleotide apical loop of an IRE can differ from the canonical CAG(U/A)GN sequence and still bind efficiently to IRPs *in vitro* (Butt et al., 1996; Henderson et al., 1996). Furthermore, current IRE prediction programs do not allow for the presence of a mismatch pair of nucleotides in the upper stem, although the IRE reported in the Gox mRNA contains one such mismatch (Kohler et al., 1999) (see Figure 5).

To overcome these limitations, the laboratory of Dr. Mayka Sanchez has created new software for the prediction of IREs which is implemented as a user-friendly web server tool. The SIREs (Search for iron-responsive elements) web server uses a simple data input interface and provides structural analysis, predicts RNA folds, folding energy data and an overall quality flag based on properties of well characterized IREs. The SIREs algorithm is implemented on a Perl script that screens for a 19 or 20 nucleotide sequence motif corresponding to the core sequence of an IRE (positions n07–n25) that includes the hexa-apical hairpin loop (n14–n19), the upper stem, the cytosine bulge (C8) and the lower base pair (n07–n25) (see Figure 3A). This core IRE region is sufficient to identify known IREs assigning them an equal RNA binding hierarchy as recently reported between IRP1 and 5' IREs (Goforth et al., 2010). The SIREs results are displayed in a tabular format and as a schematic visual representation that highlights important features of the IRE. The major advantage of the SIREs program is that it is able to detect canonical and non-canonical IREs because it integrates and allows the combination of several experimentally reported IRE structures without losing stringency in its predictions. Therefore, with this new bioinformatic software one can screen an input sequence for the existence of IRE structures and will receive a scored output (as a high, medium or low) of the predicted IRE for prioritization of further studies (see Figure 3B for the home page of the SIREs website).

Overall, the SIREs web server represents a significant improvement on currently available programs to predict IREs, providing the scientific community with an easy-to-use bioinformatics platform to identify putative IRE motifs that can then be subjected to further experimental testing *in vitro* and *in vivo*. The SIREs web server is freely available on the web at: <http://ccbgi.mppc.org/sires/index.html> (Figure 3) and was published by Campillos and collaborators (Campillos et al., 2010).

2.1.2 Iron regulatory proteins: IRP1 and IRP2

Iron regulatory proteins 1 and 2 (IRP1 and IRP2) are proteins sensitive to cytosolic iron concentrations that post-transcriptionally regulate the expression of iron metabolism genes to optimize cellular iron availability. IRP1 is encoded by the gene ACO1 found in chromosome 9p21.1 and IRP2 by the gene IREB2 found in chromosome 15q25.1. In iron-

deficient cells, IRPs bind to iron-responsive elements (IREs) found in the mRNAs of ferritin, transferrin receptor and other iron metabolism transcripts, enhancing iron uptake and decreasing iron sequestration. IRP1 registers cytosolic iron status mainly through an iron-sulphur cluster switch mechanism, alternating between an active cytosolic aconitase form with an iron-sulphur cluster ligated to its active site and an apo-protein form that binds IREs. Although IRP2 is 60 to 70% identical to IRP1 (one of the major difference is an extra 73 amino acid insertion present in IRP2), both proteins are differentially regulated. IRP2 does not have an aconitase function and its activity is regulated primarily by iron-dependent degradation through a ubiquitin-proteasomal system in iron-replete cells (see next section).

Constitutive deletion of both IRPs is embryonic lethal, demonstrating that the IRP/IRE regulatory system is essential for life (Galy et al., 2008; Smith et al., 2006). The groups of Matthias W. Hentze (EMBL) and Tracey Rouault (NIH) have reported knock-out targeted deletion strategies for IRP1 and/or IRP2 in whole animals or tissue specific. Their publications show that adult mice that constitutively lack IRP1 develop no overt abnormalities under standard laboratory conditions; however, IRP2 KO mice developed microcytic anaemia, elevated red cell protoporphyrin IX levels, high serum ferritin, and adult-onset neurodegeneration. When mice are missing both copies of IRP2 and one copy of IRP1 they develop a more severe anaemia and neurodegeneration compared with mice with deletion of IRP2 alone (Smith et al., 2006). At the cellular level, Galy and collaborators reported that mitochondrial iron supply and function also require IRPs for cellular ATP, haem and iron-sulphur cluster production (Galy et al., 2010).

Both IRPs are expressed in all tissues, however IRP1 is particularly abundant in kidney and brown fat, and IRP2 expression is higher in brain, intestine, and cells of the reticuloendothelial system (reviewed in (Cairo & Pietrangelo, 2000)).

2.1.2.1 Structure and regulation of IRPs by iron

IRP1 is a dual-functional protein with a key role in the control of iron metabolism as an IRE-binding protein and with an additional function as a cytoplasmic isoform of the aconitase enzyme (Figure 4). Aconitases are a group of iron-sulphur enzymes that require a 4Fe-4S cluster (iron-sulphur cluster, ISC) for their function. The ISC is essential to catalyse the conversion of citrate to isocitrate via the intermediate cis-aconitate during the citric acid cycle. Three iron atoms are attached to cysteine residues of the active site, whereas a fourth iron remains free and mediates catalytic chemistry (reviewed in (Eisenstein, 2000)). IRP1, as cytosolic aconitase (c-aconitase), catalyses the citrate to isocitrate conversion in the cytosol and shares 30% amino acid sequence homology with mitochondrial aconitase (m-aconitase), which catalyzes the same reaction in the mitochondrial matrix. In contrast with m-aconitase, IRP1 only retains its ISC and enzymatic function in iron-replete cells, and thus only functions as a cytosolic aconitase when cells have high levels of iron. Under iron scarcity, the ISC disassemble from holo-IRP1 and the protein is converted into IRP1 apo-protein, acquiring IRE-binding ability. Hence, IRP1 is reversibly regulated by this unusual ISC switch (Wallander et al., 2006).

The IRP1 protein is composed of four globular domains. In its c-aconitase form, domains 1-3 are compact and join domain 4 through a polypeptide linker and the ISC is central at the interface of the four domains. The ISC structure and surrounding environment are fairly well conserved between c- and m-aconitases. Nevertheless, the overall structure of holo-

IRP1 (a 889 amino acid protein), shows differences to m-aconitase, which is smaller (780 amino acids). The short IRP1 fragments that do not superimpose with m-aconitase are exposed on the surface of the protein. As a result, the shapes and surface topologies of holo-IRP1 and m-aconitase diverge substantially, which may explain the fact that IRP1 is the only aconitase that can acquire IRE binding activity.

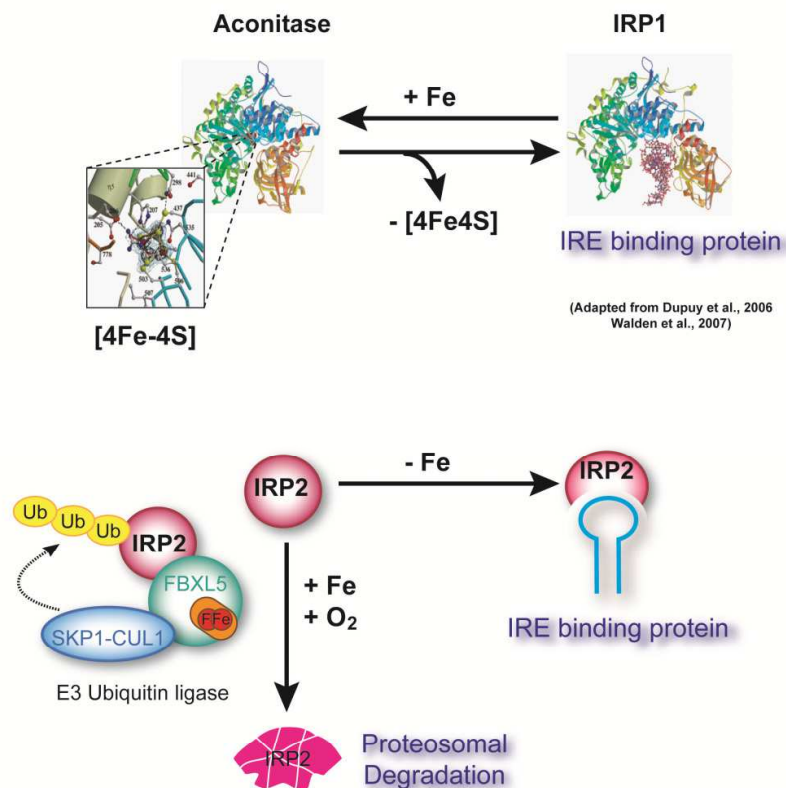

Fig. 4. Iron regulation of Iron-Regulatory Proteins IRP1 and IRP2. Under iron depleted conditions (-Fe) IRP1 and IRP2 bind to IREs. IRP1 is a bi-functional protein acting as an aconitase when it assembles an iron-sulphur cluster (4Fe-4S) or as an IRE binding protein. IRP2 undergoes proteasomal degradation via ubiquitination (Ub) when iron (Fe) and oxygen (O_2) levels are high. FBXL5: F-Box and leucine rich repeat protein 5, SKP1: S-Phase kinase-associated protein 1, CUL1: Cullin 1.

IRP1 apo-protein shows an open conformation compared with that of cytosolic aconitase, allowing its interactions with IREs and controlling the gene expression of key proteins of iron metabolism. IRP1: H-ferritin IRE crystal structural complex has been resolved at a resolution of 2.8Å and the details of its reorganization upon loss of its ISC has been described by Walden and collaborators (Walden et al., 2006). IRP1 conformational changes after loss of its ISC reveals a rotation of domain 4 and an extensive rearrangement of domain 3, creating a hydrophilic cavity that allows access to the IRE (Figure 4). The RNA-protein interaction requires two important segments at the interface of domain 2 (residues 436–442) and domain 3 (residues 534–544). Thr438 and Asn439 make direct contact with the IRE. The terminal residues of the IRE motif, A15, G16 and U17 (see figure 3A), interact with Ser371, Lys379 and Arg269 respectively within a cavity between domains 2 and 3. A second binding

site is present around the unpaired-C-bulge residue (C8 bulge, Figure 3A) located between the upper and lower stem, which occupies a pocket within domain 4, involving residues between Arg713 and Arg780. The IRE-IRP1 complex is also stabilized by additional ionic interactions. The evolutionary origin and selective advantage of the IRP1 dramatic conformational plasticity and dual functionality remains to be determined.

A second IRE-binding protein first named IRFB and lately renamed as IRP2 was isolated and characterized in rodents in 1993 (Henderson et al., 1993). This manuscript also reports that IRP1 IRE binding activity is predominant in liver, intestine, and kidney, while IRP2 revealed highest binding activity in intestine and brain. Human IRP2 has a molecular mass of 105 kD, slightly larger than human IRP1 (87kD) due to an extra 73 amino acid insertion. Human IRP2 shares 57% homology with human IRP1. Despite this homology, IRP2 is unable to assemble an iron-sulphur cluster and thus has no aconitase activity. IRP1 and IRP2's role in controlling mRNA translation and stabilization in IRE-containing mRNAs is similar, that is both proteins carry out a translational repression in 5' IREs and mRNA stabilization in 3' IREs. However unlike IRP1, IRP2 is rapidly targeted for degradation in iron-replete cells (Recalcati et al., 2010). It seems that the mechanism by which IRP2 undergoes iron-dependent degradation may involve different aspects. The 73 cysteine rich amino acid domain of IRP2 may be responsible for this degradation due to its ability to facilitate iron-dependent oxidation, ubiquitination, and proteasomal degradation (Wang & Pantopoulos, 2011). Recently, two groups have independently identified the protein FBXL5 as part of the ubiquitin ligase complex that promotes iron-dependent polyubiquitination and degradation of IRP2 (Salahudeen et al., 2009; Vashisht et al., 2009) (see Figure 4). As the stability of FBXL5 itself is controlled by iron and/or oxygen levels through an iron-binding hemerythrin-like domain located in the N-terminus, FBXL5 accumulates when iron is plentiful and is degraded upon iron depletion. By this mechanism the presence of FBXL5 in iron rich conditions works as a key sensor in the regulation of IRP2 degradation. No crystal structure of IRP2 is available as of yet, and forthcoming experiments will allow us to elucidate the role (if any) of the extra amino acid residues in IRP2 IRE binding specificity and/or their role in protein degradation. Ultimately, the crystallization of IRP2, especially in a complex with IRE, will be necessary to precisely map the RNA-protein interactions and further shed light on its mechanistic properties (Wang & Pantopoulos, 2011).

2.1.2.2 Regulation of IRPs by other stimuli than iron

Iron was the first identified regulator of the IRP/IRE network however various other stimuli, drugs and pathological agents have been reported to affect IRP activity.

Hypoxia

IRP1 and IRP2 are regulated by oxygen levels (reviewed in (Rouault, 2006)) which control their binding activity. Hypoxia has been shown to decrease the binding to IREs in IRP1 by favouring the assembly of the ISC and causing IRP1 to acquire aconitase activity, but increasing IRP2 activity (Meyron-Holtz et al., 2004). Other studies also reported an opposite regulatory effect of hypoxia on IRP1 and IRP2 IRE binding activities, though not all studies agree on the direction of this divergent modulation. As described in section 2.1.2.1 IRP2 degradation is controlled by FBXL5 in an iron- and oxygen-dependent manner, which suggests one possible explanation for the differential regulation of the two IRPs by hypoxia. At low oxygen concentrations, which favour the assembly of an ISC of IRP1 and stabilise IRP2,

the latter regulates iron homeostasis but, at high oxygen concentrations, FBXL5 is stabilised, interacts with IRP2 and induces its degradation, whereas the apoform of IRP1 can bind and regulate the mRNAs encoding proteins of iron metabolism. These mechanisms may therefore allow cells to regulate iron metabolism effectively over a broad range of oxygen availability.

Hypoxia has also been shown to reduce IRP1 binding to HIF-2 α mRNA via a newly identified 5' IRE (see section 2.1.3.5), while slightly increasing binding to IRP2 (Zimmer et al., 2008). Interestingly, these authors describe a major effect of IRP1 on de-repression of HIF-2 α translation in hypoxic conditions, and they suggest that IRP1 acts as a direct or indirect sensor of hypoxia, which is somehow contradictory to the previous reported predominant role of IRP2 at physiologically low oxygen levels (3%-5%). This work was done in the context of renal cells in which IRP1 is particularly abundant, and this may explain the main regulatory role of IRP1 in HIF translation during hypoxia.

Oxidative stress

Both IRP1 and IRP2 are sensitive to ROS (Reactive Oxygen Species) and RNS (Reactive Nitrogen Species) (reviewed in (Cairo & Pietrangelo, 2000)). As explained earlier, the redox regulation of IRP1 is mediated by its iron-sulphur cluster (ISC) switch. Exposure of cells to H₂O₂ leads to the removal of ISC and conversion of IRP1 into a null protein lacking both RNA binding and aconitase activities. This conversion can be reversed by myeloperoxidase-derived hypochlorite (Mutze et al., 2003).

Early studies of exogenous H₂O₂ exposure to cell lines were shown to increase IRP1 expression (Cairo & Pietrangelo, 2000) though this was later shown to be a consequence of signalling pathway effects rather than direct oxidative stress on IRP1 (Caltagirone et al., 2001). Successive studies in various cell models have reported a number of agents (superoxide, phorone, quinone) (reviewed in (Recalcati et al., 2010)) with the ability to increase cellular H₂O₂ and O₂⁻ and reversibly inactivate IRP1. This opens up the question of whether IRP1 inactivation (and subsequent TFR1 down-regulation, ferritins up-regulation and therefore decreasing LIP) is a homeostatic response to subdue ROS formation.

ROS studies on IRP2 have revealed seemingly contradictory results to date. Iwai and collaborators suggested that ROS triggers down-regulation of IRP2 by alterations to "sensitive" amino acid residues leading to ubiquitin-dependent proteasomal degradation (Iwai et al., 1998). However, a more recent study reported that treatment of murine macrophage cells with exogenous H₂O₂ protects IRP2 against iron and increases its IRE-binding activity (Hausmann et al., 2011). Moreover, they also showed that IRP2 is stabilized during menadione-induced oxidative stress suggesting that the degradation of IRP2 in iron-replete cells is not only oxygen-dependent but also sensitive to redox perturbations. Overall, further in-depth analysis of the exact role of oxidative stress is needed to properly evaluate its specific role in iron homeostasis.

Nitric Oxide

Nitric Oxide (NO) is a vital signalling and effector molecule that can rapidly switch IRP1 from its holo- to the apo-form (Drapier, 1997). NO is produced by NO synthases and once released, attacks the ISC of IRP1 promoting its gradual disassembly and complete removal suggesting this NO-mediated switch could represent a homeostatic response to iron starvation. NO has also been implicated in promoting iron efflux from cells (Drapier, 1997).

The effect of NO on IRP2 has also been studied, although with contradictory results. Wang and collaborators claimed that IRP2 was activated under NO exposure (Wang et al., 2005), whereas Kim and collaborators demonstrated that IRP2 degradation was NO-dependent (S. Kim et al., 2004). Mulero and collaborators showed that IRP2 had a lack of regulation by NO (Mulero & Brock, 1999). Furthermore, it has been reported that endogenous and exogenous NO increases (S. Kim & Ponka, 2002) or decreases (Pantopoulos & Hentze, 1995) ferritin levels and further discrepant results of TfR1 regulation by NO has been described (Pantopoulos & Hentze, 1995). As a result, the role of the IRP/IRE system in NO-mediated regulation of cellular iron metabolism still remains unknown.

Other antioxidants, such as ascorbate, α -tocopherol and N-acetylcysteine have also been shown to disturb the IRE/IRP regulation system by promoting the proteasomal turnover of IRP2 (Wang et al., 2004).

Other stimuli that affect IRP regulation: Hormones and viruses

A number of hormones and viruses have been documented as interacting with IRPs and regulating iron metabolism. In an extensive report, *in vitro* and *in vivo* studies of the thyroid hormone showed that it functionally regulates the IRE binding activity of the IRPs to ferritin mRNA (Leedman et al., 1996). Estrogens modulate the RNA binding of IRP1 in adipose tissue and consequently the expression of ferritin and TfR1 (Mattace Raso et al., 2009).

Given the importance of iron in viral infections and replication (Drakesmith & Prentice, 2008) several studies have outlined the impact of viruses on iron homeostasis. In the case of Herpes Virus-1 infection of Madin-Darby bovine kidney cells, IRP RNA binding activity was reported to be reduced (Maffettone et al., 2008). However, this effect may be due to different factors, as shown in studies on the hepatitis B virus X protein that produced an increase in ROS and thus IRP1 down modulation (Gu et al., 2008). Similarly, in a cell culture model of hepatitis C virus replication, the down-regulation of TfR1, increased FPN levels and reduced LIP were associated with concomitant induction of IRE-binding activity and IRP2 expression (Fillebeen et al., 2007).

Other stimuli that affect IRP regulation: Xenobiotics

Many studies of xenobiotic effects on the IRP/IRE regulatory system have been performed with Doxorubicin (DOX). DOX is an anti-cancer anthracycline that causes a severe form of chronic cardiomyopathy. The alcohol metabolite of DOX (DOXol) breaks iron away from the iron-sulphur cluster of cytoplasmic aconitase and the O₂ free radicals and H₂O₂ derived from the redox activation of DOX convert IRP1 to a null protein (Brazzolotto et al., 2003). In another study it was shown that this null protein does not actually rely on the action of DOXol but on anthracycline-iron complexes attacking both aconitase and IRP1 (Kwok & Richardson, 2002). IRP2 protein does not contain an ISC and is not affected by DOXol, but is degraded by the action of the ROS that is produced (Minotti et al., 2001). The ability of DOX to regulate the RNA binding activity of IRP1 and IRP2 may also be due to its anti-tumoral and cardiotoxic activities. The possibility of combining DOX with other anti-neoplastic drugs is currently being tested for clinical applications.

Other stimuli that affect IRP regulation: Cell growth

Iron homeostasis and cell growth are interrelated because iron is essential for cell proliferation and is especially required in neoplastic cells as they proliferate faster and thus

require elevated iron supplies. This is demonstrated by a higher expression of Tfr1 and higher transferrin iron uptake in cancer cells. In addition, iron is required for the function of many proteins involved in cell cycle and DNA synthesis (e.g. Ribonucleotide Reductase). Moreover, iron appears to play a critical role in the expression and regulation of a number of molecules that control cell cycle progression e.g. p53, GADD45 and WAF1/p21 (Gao et al., 1999). In fact, without iron, cells are unable to proceed from G1 to the S phase of the cell cycle due to post-transcriptional regulation caused by iron depletion in cyclin D1 expression (a protein that plays a critical role in G1 progression) (Nurtjahja-Tjendraputra et al., 2007).

The cell cycle further manipulates the IRP/IRE regulatory system as IRP2 is phosphorylated at Ser 157, independently of iron levels, by Cdk1/cyclin B1 during the G2/M phase of the cell cycle, and in turn dephosphorylated by CDC14A after mitosis. This reduces IRP2 RNA binding activity in the G2/M phase of the cell cycle, increasing ferritin synthesis and impairing Tfr1 mRNA stability (Wallander et al., 2008). Therefore, it seems that this reversible phosphorylation of IRP2 facilitates cell cycle progression. It has been shown that IRP activity is high in a classical model of non-neoplastic cell growth such as liver regeneration (Cairo & Pietrangelo, 1994). Cell proliferation induces IRP2 activity possibly because of the combined effect of high iron consumption in growing cells and IRP2's preferential sensitivity to iron deprivation (Recalcati et al., 1999). However, the fact that IRP2 transcription is specifically stimulated by a c-myc oncogene (Wu et al., 1999) suggests that the induction of IRP2 activity (with consequent ferritin repression and Tfr1 up-regulation) may be specifically aimed at ensuring sufficient iron for the metabolic requirement of proliferating cells.

In 2006, Sanchez and collaborators reported a novel IRE located in the 3' UTR of the cell division cycle 14A (CDC14A) mRNA that efficiently binds both IRP1 and IRP2 (Sanchez et al., 2006) (see also section 2.1.3.5). Differential splicing of CDC14A produces IRE- and non-IRE-containing mRNA isoforms. Interestingly, only the expression of the IRE-containing mRNA isoforms is selectively increased by cellular iron deficiency. This uncovered a previously unrecognized regulatory link between iron metabolism and the cell cycle.

2.1.3.1 The IRP/IRE regulatory network in iron uptake

The main cellular iron uptake pathway is mediated by Transferrin Receptor 1 (TFR1, gene located on chromosome 3q29), which internalises iron-bound transferrin (TF) via a receptor-mediated endocytosis mechanism (Ponka et al., 1998). Iron-loaded transferrin binds with high affinity to TFR1 on the surface of cells, and the complex undergoes endocytosis via clathrin-coated pits. Once inside the endosome, a proton pump lowers the pH to 5.5, resulting in the release of Fe³⁺ from transferrin. Subsequently, the affinity of transferrin to TFR1 falls about 500-fold, resulting in its de-attachment of the TFR1-TF complex. In the final step of the cycle, non-iron bound transferrin is secreted into the bloodstream to recapture more Fe³⁺ and the transferrin receptor 1 protein is again relocated in the cell surface for another round of endocytosis.

TFR1 is expressed in many cells and plays a relevant function in erythroid iron acquisition for haem synthesis and haemoglobinization. Its expression parallels the maturation of erythroid progenitors and is involved in the development of erythrocytes and the nervous system (Levy et al., 1999).

Knockout mice homozygous for a null mutation in the transferrin receptor 1 (Tfr1) gene die after 12.5 days from severe anaemia and neurological abnormalities during embryonic development (Levy et al., 1999). These mice have a more severe phenotype than homozygous hypotransferrinaemic (*hpx/hpx*) mice that carry a mutation in the transferrin gene and have a severe reduction of transferrin expression. Haploinsufficiency for Tfr1 (Tfr1^{+/-}) results in impaired erythroid development with microcytic, hypochromic erythrocytes and abnormal iron homeostasis with mild tissue iron depletion in liver and spleen. In this regard, Tfr1^{+/-} mice differ from *hpx/hpx* and *+/hpx* mice, which have increased intestinal iron absorption leading to tissue iron overload.

TFR1 expression is controlled by iron and oxygen status amongst other factors (Cairo & Pietrangelo, 2000). At the transcriptional level, TFR1 is regulated by the hypoxia-inducible factor HIF1 in response to low oxygen levels and iron starvation (Bianchi et al., 1999). In addition, the TFR1 promoter region contains potential binding sites for transcription factors such as c-myc (O'Donnell et al., 2006). Nevertheless, in most cells TFR1 expression is mainly controlled post-transcriptionally by cellular iron levels through binding of IRP1 and IRP2 to five IREs located in the 3' UTR of the TFR1 mRNA (see Figure 2). TFR1 mRNA is stabilized by the binding of IRPs under iron-starved conditions by a mechanism that involves the protection of the mRNA degradation by a cleavage of a putative, as yet unidentified, endonuclease (Figure 1). This mechanism will ensure an increased expression of TFR1 in the cell surface to stimulate the acquisition of iron from plasma transferrin, and it will be blocked in iron-replete cells. However, the IRP/IRE regulation of TFR1 mRNA is overridden in specialized cells such as the erythroid progenitor cells, where TFR1 mRNA stability is uncoupled from iron supply and IRP regulation to ensure efficient massive iron uptake needed in these cells for haem synthesis and haemoglobinisation. In these cells TFR1 expression is regulated transcriptionally by a promoter erythroid active element (Lok & Ponka, 2000).

The SLC11A2 gene, located on chromosome 12q13, encodes a member of the solute carrier 11 protein family named Divalent Metal Transporter 1 (DMT1) or natural resistance-associated macrophage protein 2 (Nramp2). DMT1 is a glycoprotein that consists of twelve transmembrane domains and transports reduced ferrous iron (Fe⁺²) and other divalent metals (manganese, cobalt, nickel, cadmium, lead, copper, and zinc) to the inside of duodenal enterocytes, where it is highly expressed at the apical (luminal) site (Mackenzie & Garrick, 2005).

Inorganic iron absorption via DMT1 is an important iron uptake pathway, as observed in homozygous *mk/mk* mice that have microcytic, hypochromic anaemia due to severe defects in intestinal iron absorption and erythroid iron utilization. By positional cloning, Fleming and collaborators discovered in 1997 that a missense mutation in the gene Nramp2 was responsible for the *mk* mouse phenotype (Fleming et al., 1997). One year later the same group also reported that a similar phenotype present in Belgrade (b) rats was due to the same missense mutation, a glycine-to-arginine missense mutation (G185R), in the Nramp2 gene (Fleming et al., 1998). Functional studies of the protein encoded by the mutated b allele of rat Nramp2 demonstrated that the mutation disrupted iron transport. Therefore, the phenotypic characteristics of *mk* mouse and Belgrade rats indicate that Nramp2 is not only essential for normal intestinal iron absorption but also for transport of iron out of the transferrin cycle endosome.

DMT1 is a conserved transporter in vertebrates and the phenotype called chardonnay (*cdy*) in zebrafish mutants with hypochromic, microcytic anaemia is due to a nonsense mutation in DMT1. The truncated DMT1 protein expressed in *cdy* mutants is not functional (Donovan et al., 2002). In humans, mutations in this gene are associated with hypochromic microcytic anaemia with iron overload. This is a very rare disease so far described in only five subjects (OMIM 206100).

The SLC11A2 gene encodes four transcripts that are the result of alternative splicing at the 5' or 3' end, yielding DMT-1A-IRE, DMT-1B-IRE, DMT-1A-nonIRE, and DMT-1B-nonIRE isoforms. The different isoforms of DMT1 are differentially expressed in tissues, increasing somewhat the complexity of the study of this gene (Hubert & Hentze, 2002). One of the two 3' splicing forms (the IRE isoform) contains an IRE structure in its 3' UTR (see Figure 2) and is up-regulated by iron deficiency via the IRPs (Mackenzie & Garrick, 2005); however, the regulation of DMT1 is very complex and both transcriptional and post-transcriptional regulations may be involved in its gene expression regulation. The ablation of both IRPs in intestinal epithelial cells reduces the levels of IRE-containing DMT1 mRNA and DMT1-dependent intestinal iron uptake (Galy et al., 2008), but transcriptional regulation may be important, as is also suggested by recent studies showing that HIF2 α -dependent DMT1 transcription plays a role in intestinal iron uptake (Mastrogiannaki et al., 2009).

2.1.3.2 The IRP/IRE regulatory network in iron storage

In addition to iron recycling and absorption, the storage and potential release of (excess) iron are critical determinants of circulating iron levels. Under physiological conditions, approximately 20% (0.5 to 1g) of the body's total iron content is stocked in the storage compartment, and only 1 to 2mg of iron is lost each day. The iron stores become depleted when iron absorption does not meet the body's needs or in cases of excessive iron loss (e.g. bleeding, pregnancy); conversely, tissue iron overload occurs when intestinal iron absorption surpasses iron utilization and loss (Andrews, 2010). Iron storage should be therefore tightly controlled to avoid an iron imbalance that will lead to a disease stage.

Ferritins are the major iron storage protein, and are found in the cytoplasm, mitochondria, and nucleus of the cells (Arosio et al., 2009). In vertebrates, cytoplasmic ferritin is expressed in almost all tissues and plays an important role in the control of intracellular iron distribution. Ferritin consists of a 24-subunit heteromultimer of light (L) and heavy (H) chains (174 and 182 amino acids respectively) that form a spherical shell around a cavity where iron (as ferric oxide) is stored. Each subunit has a distinct role in iron metabolism: L-ferritin facilitates iron-core formation and H-ferritin subunit generates ferroxidase activity (converting Fe⁺² to Fe⁺³) to incorporate iron into the protein shell. Plant and bacteria ferritins have only a single type of subunit which probably fulfils both functions. L- and H-ferritin subunits are synthesized by two different genes located on chromosomes 19q13.2 and 11q13, respectively. Although both genes are ubiquitously expressed, post-transcriptional regulation mediates tissue-specific changes in the H/L mRNA ratio.

The best characterized system regulating ferritin expression is the post-transcriptional, iron-dependent machinery based on the interaction between the IRPs and IREs localized in the 5' untranslated region of H- and L-ferritin mRNA (Muckenthaler et al., 2008) (see Figure 1 and 2). Iron deficient cells need to rapidly mobilize the iron storage pool and in these conditions there is no need for the production of ferritins. This is achieved through the formation of

IRP/IRE complexes in the 5'UTR of ferritins that inhibits translation in iron-starved cells. Mechanistically, this translational block is due to the IRP interference in the recruitment of the small ribosomal subunit to the mRNA by preventing the interactions between the cap binding complex eIF4F and the small ribosomal subunit (Muckenthaler et al., 1998). The rate of *de novo* synthesis and abundance of ferritin can change over a 50-fold range in response to variations in iron availability mainly via the IRP/IRE regulatory system and thus the transcripts of the H- and L-ferritin chains are the prototypes of IRP-mediated translational control.

In vivo disruption of the H-ferritin gene by homologous recombination (Fth^{-/-} mice) is early embryonic lethal (Ferreira et al., 2000). Fth^{-/-} embryos die between 3.5 and 9.5 days of development, suggesting that there is no functional redundancy between the two ferritin subunits and that, in the absence of H subunits, L-ferritin homopolymers are not able to maintain iron in a bioavailable and nontoxic form. Fth^{+/-} mice are healthy, fertile, and do not differ significantly from their control littermates. To overcome this embryonic lethality of Fth^{-/-} mice, the group of Dr. Lukas Kuhn has recently created an intestine-specific H-ferritin knock-out mouse model (Vanoaica et al., 2010), which shows that not only is hepcidin required for an accurate control of iron absorption, but H-ferritin is also critical for limiting iron efflux from intestinal cells. These mice with an intestinal H-ferritin gene deletion show increased body iron stores and transferrin saturation that resembles Hereditary Hemochromatosis (HH).

In humans defects in the L-ferritin gene are associated with a neurodegenerative disease (NBIA3, neurodegeneration with brain iron accumulation 3, OMIM #606159), genetic hyperferritinemia without iron overload (Kannengiesser et al., 2009) and hyperferritinemia-cataract syndrome (HHCS). A mutation in the H-ferritin gene causes the autosomal dominant Iron overload syndrome. The hyperferritinemia-cataract syndrome (HHCS, OMIM #600886) and the autosomal dominant Iron overload syndrome (OMIM +134770) are due to specific mutations in the IRE motif of H- and L-ferritin, respectively and are extensively discussed in sections 3.1 and 3.2.

2.1.3.3 The IRP/IRE regulatory network in iron release

The transmembrane protein Ferroportin (FPN) is encoded by the SLC40A1 gene (chromosome 2q32.2) and this protein is the only known cellular iron exporter (Donovan et al., 2005). FPN is ubiquitously expressed, but is more abundant on the basolateral membrane of enterocytes in the duodenum and in reticuloendothelial cells. Ferroportin plays an important role in iron absorption (i.e. iron transport from enterocytes into the plasma) and iron reuse (i.e. iron released out of macrophages and coming from erythrophagocytosis of senescent or damaged red blood cells) (Hentze et al., 2010).

FPN is post-translationally regulated by hepcidin, which plays a central role in controlling systemic iron levels. On hepcidin binding, FPN is internalized and degraded (Ganz & Nemeth, 2011), thus inhibiting iron efflux from enterocytes, macrophages, and other cells.

FPN is also regulated at the post-transcriptional level by the IRP/IRE regulatory system (Figure 1). FPN mRNA bears a functional IRE motif in its 5'UTR (see Figure 2) that allows it to respond to iron manipulations in hepatic, intestinal, and monocytic cells (Lymboussaki et al., 2003). Similarly to ferritin IRP control, in iron deprivation the IRP binding to the

ferroportin 5' IRE will inhibit its translation. The simultaneous ablation of IRP1 and IRP2 in mice markedly increases intestinal FPN expression, despite the increase in hepatic hepcidin expression, indicating that IRPs are as critical as hepcidin for physiological FPN expression in the intestine (Galy et al., 2008). The IRP-dependent translational control of FPN expression has been found in response to nitric oxide (NO) (X. B. Liu et al., 2002) and erythrophagocytosis (Delaby et al., 2008). Duodenal epithelial and erythroid precursor cells utilize an alternative upstream promoter to express a FPN1 transcript, FPN1B, which lacks the IRE and therefore this FPN isoform will escape the IRP repression in iron-deficient conditions (Zhang et al., 2009).

SLC40A1 gene mutations are associated with an autosomal inherited genetic iron disorders described as ferroportin disease. Indeed, ferroportin disease is phenotypically heterogeneous with two sub-types. Classical ferroportin disease is the usual form and is characterized by hyperferritinemia, normal or low transferrin saturation, and iron overload in macrophages. This form is generally asymptomatic with no tissue damage and is due to ferroportin mutations that lead to a loss of function. The non-classical ferroportin form is rarer and resembles Hereditary Hemochromatosis with hepatocellular iron deposits and high transferrin saturation. In this form, ferroportin mutations are responsible for a gain of function with full iron export capability but resistance to down-regulation by hepcidin, which leads to a phenotype similar to hepcidin deficiency-related HH (i.e. types 1, 2, and 3). In fact, the non-classical ferroportin form is also known as Hereditary Hemochromatosis type 4. Most of the described mutations in ferroportin are located in the coding region or in exon-intron boundaries, only one patient with iron-overload Hereditary Hemochromatosis type 4 has been described with a point mutation close to the FPN IRE. This mutation could alter the IRE structure and the IRP regulation of FPN, but this was not studied further (Liu et al., 2005). In addition, radiation-induced polycythaemia (Pcm) mice were shown to have a ferroportin promoter microdeletion that also eliminates the iron-responsive element (IRE) in the 5' untranslated region (Mok et al., 2004) (see section 3.3).

2.1.3.4 The IRP/IRE regulatory network in iron utilization and energy metabolism

The erythroid iron utilization is also controlled by the IRP/IRE system through the interaction with ALAS2 mRNA. ALAS2 (erythroid-specific 5-aminolevulinic acid synthase) mRNA encodes for the first and rate-limiting enzyme in the haem biosynthesis pathway. This mRNA contains a 5' UTR IRE (see Figure 1) identified using an *in silico* approach, and it is translationally repressed by the binding of the IRPs in iron-deficient conditions preventing the accumulation of toxic intermediates of the haem biosynthesis pathways such as protoporphyrin IX (Dandekar et al., 1991). The regulation of the *Alas2* mRNA by the IRPs is affected in the zebrafish mutant *shiraz*, which presents severe hypochromic anaemia and early embryonic lethality due to defects in the *Grx5* gene (Wingert et al., 2005). *Grx5* protein is required for iron-sulphur cluster assembly and its abrogation shifts IRP1 conformation to an IRE-binding protein that leads to *Alas2* repression and cytosolic iron depletion that also activates IRP2, which will further contribute to the repression of *Alas2*. A patient with iron overload and mild sideroblastic anaemia was described as bearing a homozygous mutation that interferes with intron 1 splicing and drastically reduces *GLRX5* mRNA levels (Camaschella et al., 2007). Surprisingly, in this patient the anaemia was worsened by blood transfusions but partially reversed by iron chelation, presumably because iron chelation will redistribute iron to the cytosol, which might decrease IRP2 excess, improving haem

synthesis and anaemia. These intricate mechanisms reveal the control of the IRP/IRE regulatory system in haem biosynthesis during erythroid differentiation, as well as the coordination of the regulation of haemoglobin with the iron-sulphur cluster assembly machinery.

The IRP/IRE system also controls energy metabolism by the regulation of two iron-sulphur containing enzymes of the tricarboxylic acid cycle (TCA cycle), the mitochondrial aconitase Aco2 and the *Drosophila* succinate dehydrogenase B, SdhB. These two mRNAs contain a single 5' UTR IRE that were identified using the same IRE bio-computational searching approach as previously mentioned (Gray et al., 1996) (see Figure 1). The translational regulation of these mRNAs by the IRPs may co-ordinate their expression with iron availability since these are iron-containing enzymes, and altogether influence energy metabolism.

There is evidence that the translational repression exerted by the IRPs varies depending on the targeted mRNA. For instance, IRP regulation of ferritin transcripts is stronger than IRP Aco2 repression (Schalinske et al., 1998), this is in part due to differences in binding affinities of the IRPs for each particular transcript (Goforth et al., 2010).

2.1.3.5 The IRP/IRE regulatory network in other pathways

Apart from the IREs found in transferrin receptor 1, DMT1, H- and L-ferritins, ferroportin, Alas2, Aco2 and DSdhB already discussed, it seems that the IRP/IRE regulatory network is wider than previously thought and may regulate pathways not directly related to iron homeostasis (Sanchez et al., 2011).

Several groups have reported new IRE-containing mRNAs using different approaches

By computational searches, an IRE was described in the 3' UTR of the human MRCK α , also known as CDC42 binding protein kinase alpha (CDC42BPA) (Cmejla et al., 2006) (see Figure 5). This kinase is the effector of a small Rho GTPase Cdc42 and promotes cytoskeletal reorganization. The authors claim that the mRNA of MRCK α is regulated by iron in a similar but less intense way to TFR1 mRNA and they proposed a novel molecular link between iron metabolism and the cellular cytoskeleton.

Members of our group have found a conserved and functional 3' UTR IRE in a splicing mRNA isoform coding for CDC14A, a highly evolutionarily conserved cell-cycle phosphatase (Sanchez et al., 2006) (see Figure 5). The CDC14A mRNA and other mRNAs were bioinformatically predicted to bear a conserved IRE and subsequently spotted on a home-made iron-specific microarray. The CDC14A and HIF2 α mRNAs (see below) were isolated by IRP immunoprecipitation, using total RNA derived from human cell lines, and identified using this same iron-specific microarray. The mRNA levels of the human CDC14A IRE isoform were shown to be specifically increased upon iron deprivation and it is possible that the regulation of CDC14A by the IRPs participates in the cell-cycle arrest observed during iron scarcity in cells. This finding opens up new interesting links between iron metabolism and cell cycle regulation.

The approach described above also revealed an atypical IRE in the 5' UTR of HIF2 α mRNA, which encodes for a key transcription factor induced by lack of oxygen (hypoxia) or iron (Sanchez et al., 2007). The IREs of HIF2 α and DMT1 mRNAs have an additional bulge on the

3' strand of the upper stem (see Figure 2). Under normoxic conditions, IRPs bind to the 5' IRE of HIF2 α mRNA and repress its translation, whereas hypoxia de-represses HIF2 α mRNA translation by impairing IRP binding activity and prevents HIF2 α degradation by inhibiting prolyl hydroxylase activity. This mechanism was proposed to modulate the levels of erythropoietin, a major target of HIF2 α , adjusting the rate of red blood cell production to iron availability. Therefore, we discovered a negative feedback control of the HIF-mediated response under conditions of limited iron availability. HIF2 α also regulates the expression of genes involved in angiogenesis and vascularisation (i.e. VEGF, PDGF), but the effect of the IRP/IRE system on these HIF2 α targets has yet to be studied. To investigate the physiological and pathophysiological role of HIF2 α IRE *in vivo* and the effect of its ablation on haematopoiesis and cancer development it would be necessary to generate a knock-in mouse model, in which the IRE-IRP interaction is selectively disrupted.

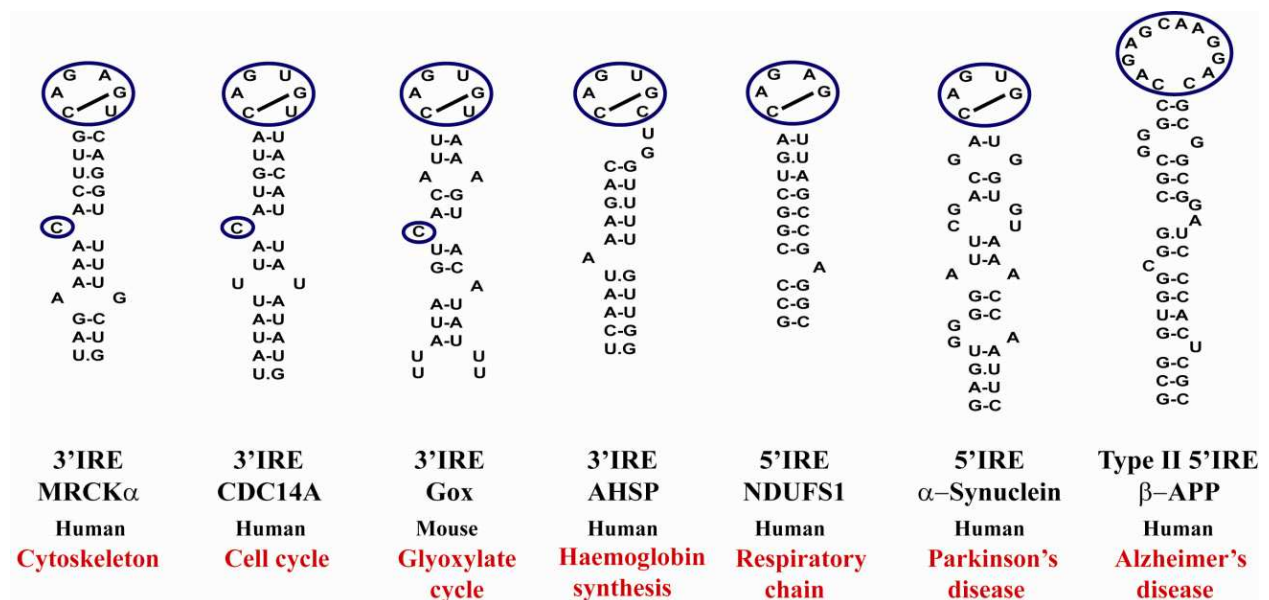

Fig. 5. Other poorly conserved IREs and the role of their encoded proteins. Apical loops and C-bulges are circled in blue. 5' or 3' location of the IRE and the specie where it is found are shown. The function of the encoded protein is shown in red. MRCK α : CDC42-binding protein kinase alpha, CDC14A: Cell division cycle 14A, Gox: Glycolate oxidase, AHSP: Erythroid-associated factor, NDUFS1: NADH-ubiquinone oxidoreductase Fe-S protein, β -APP: Amyloid beta A4 precursor protein.

Additional non-canonical and poorly conserved IREs have been described in different mRNAs.

An IRE-like structure is present in the 3'UTR of mouse glycolate oxidase (Gox), a liver-specific mRNA (Kohler et al., 1999) (see Figure 5). This novel IRE-containing mRNA was detected by enrichment of mRNAs using an affinity IRP1 matrix; positive mRNAs were then cloned in a cDNA library and screened by RNA-protein band shift assays. The main difference from a canonical IRE was the presence of a mismatched (A:A) nucleotide pair in the middle of the upper stem. This IRE-like sequence exhibited strong binding to IRPs at room temperature but not at 37 degrees and translational regulation in response to iron deprivation was not observed when the 3'IRE was cloned at a 5' position of a reported

construct. These observations brought the authors to claim that such an IRE is not functional in cells.

In primate sequences of the mRNA encoding for the alpha-haemoglobin-stabilizing protein (AHSP), a molecular chaperone that binds and stabilizes free alpha-globin during haemoglobin synthesis, a 3' UTR IRE-like sequence was detected using an RNA folding program (Meehan & Connell, 2001) (see Figure 5). The main difference between this and a canonical IRE is the presence of an A8 bulge nucleotide instead of a C8 and in 2 additional unpaired nucleotides (UG) at the 3' end of a typical CAGUGH apical loop. Although this IRE-like structure binds IRPs poorly in electrophoretic mobility shift assays, in cytoplasmic extracts the AHSP mRNA co-immunoprecipitates with IRPs via this element and this interaction is inhibited by iron. The IRP- AHSP interaction enhances AHSP mRNA stability in erythroid and heterologous cells.

The human 75-KDa subunit of mitochondrial complex I (NDUFS1) is regulated by iron at the protein but not at the mRNA level (Lin et al., 2001). In the 5' UTR of this mRNA a motif element that resembles an IRE was identified; however this element does not contain a C8 bulged nucleotide and in it the apical loop (CAGAG) is formed by only five nucleotides instead of six (see Figure 5). Interestingly, this element is bound by a specific cytoplasmic protein, which is neither IRP1 nor IRP2 and the binding interaction can be competed with ferritin IRE and was affected by iron status. It has been suggested that NDUFS1 may be regulated by a novel IRP/IRE system.

A type II IRE motif was found in the 5' UTR of the human mRNA encoding the Alzheimer's beta amyloid precursor protein (β -APP), which functions as a translational control element via interaction with IRP1 (Rogers et al., 2002) (see Figure 5). This IRE is structurally different from the one presented earlier. Also, a very atypical IRE motif was predicted in the 5'UTR of the human α -synuclein mRNA involved in Parkinson's disease (see Figure 5); however, no functional characterization was reported (Friedlich et al., 2007). As brain iron homeostasis is disrupted in a number of neurodegenerative disorders, a deeper understanding of the functional IRP regulation of mRNAs involved in these diseases is of great interest.

IRE-like structures were reported in the *Bacillus subtilis* genome and the aconitase of this gram-positive bacterium was described as an RNA-binding protein (Alen & Sonenshein, 1999). *B. subtilis* aconitase mutants demonstrate that its non-enzymatic activity is important for sporulation, an iron-dependent process. The authors suggest that bacterial aconitases, like their eukaryotic homologues, are bi-functional proteins, showing aconitase activity in the presence of iron and RNA binding activity in iron-deprived conditions.

A recent genome-wide study was carried out by our group to identify the whole repertoire of mRNAs that can interact with the IRPs (Sanchez et al., 2011). IRP1/IRE and IRP2/IRE mRNP complexes were immunoselected and the mRNA composition of the IRP-binding transcripts was determined using whole-genome microarrays. In this strategy we used total mRNA from five different mouse tissues relevant for iron metabolism (liver, duodenum, spleen, bone marrow and brain). Using this approach novel mRNAs that can bind to both IRPs (n=35), as well as specific-IRP1 mRNAs (n=101) and specific-IRP2 mRNAs (n=113) were detected for the first time. Bioinformatic analysis to predict IRE motifs in the novel IRP target mRNAs was carried out using the newly developed software called SIREs (Searching

for IREs, (Campillos et al., 2010), see section 2.1.1.1) also designed by our group. Some of the novel IRP target mRNAs were tested *in vitro* in IRP1 competitive binding assays. We also undertook a proteomic approach to identify iron and/or IRP-modulated proteins in an iron-regulated mouse hepatic cell line and in bone marrow derived macrophages from IRP1- and IRP2-deficient mice. We are currently proceeding with the functional characterization (iron and IRP regulation) of these novel mRNAs to discover and connect known and new cellular functions that need to respond to changes in iron metabolism.

3. Diseases affecting the IRP/IRE regulatory network

In humans, several diseases are caused by the disturbance of systemic or cellular iron homeostasis. In particular for cellular iron misregulation involving the IRP/IRE regulatory system several diseases have been reported and are described in the sections below.

3.1 Hyperferritinemia-cataract syndrome (OMIM #600886)

“Hereditary Hyperferritinemia-Cataract Syndrome” (HHCS) was first described in 1995 (Bonneau et al., 1995; Girelli et al., 1995) as an autosomal dominant inherited disorder characterised by markedly elevated serum ferritin levels (≥ 1000 ng/ml) without iron overload and congenital early onset bilateral cataract.

The absence of iron overload in HHCS patients suggested that the elevated serum ferritin resulted from misregulation of L-ferritin expression. Analysis of the L-ferritin genetic locus in HHCS patients led to the identification of heterozygous mutations occurring within the IRE of the L-ferritin gene. An inability to block ferritin translation in this disorder has been demonstrated by experiments using cultured lymphoblastoid cells from affected patients: the mutation abolishes the binding of IRPs and leads to constitutively high levels of L-ferritin synthesis (Cazzola et al., 1997). The clinical phenotype of these mutations is only the presence of bilateral congenital cataracts. Although the mechanism of cataract formation is not clear, the deposit of excess L-ferritin in the lens seems to be responsible. A comprehensive study of cataract features in several families affected by HHCS has been performed by Craig and colleagues (Craig et al., 2003).

Since 1995, numerous mutations affecting the 5' IRE of L-ferritin have been described, including deletions and point mutations (Millonig et al., 2010). A comprehensive revision of the described mutations in HHCS is shown in Figure 6. Most of the mutations discovered so far are located in the upper stem and the conserved hexa-nucleotide apical loop of the IRE. Historically, the L-ferritin IRE mutations have been described with the name of the city in which mutations were identified followed by the nucleotide position and change (i.e. Verona 1 (+41) C). Up to now, less than 90 families have been diagnosed with the disease around the world, so it appears to be uniformly widespread. Prevalence of this disease still needs to be precisely determined but it is estimated to be at least 1 in 200,000 according to the Orphanet database.

Our group have recently diagnosed four Spanish families (ten individuals) affected by HHCS that present four previously described single point mutations in the IRE of the L-ferritin (unpublished data, Figure 7). All our cases present high levels of serum ferritin and cataracts that were detected at a young age.

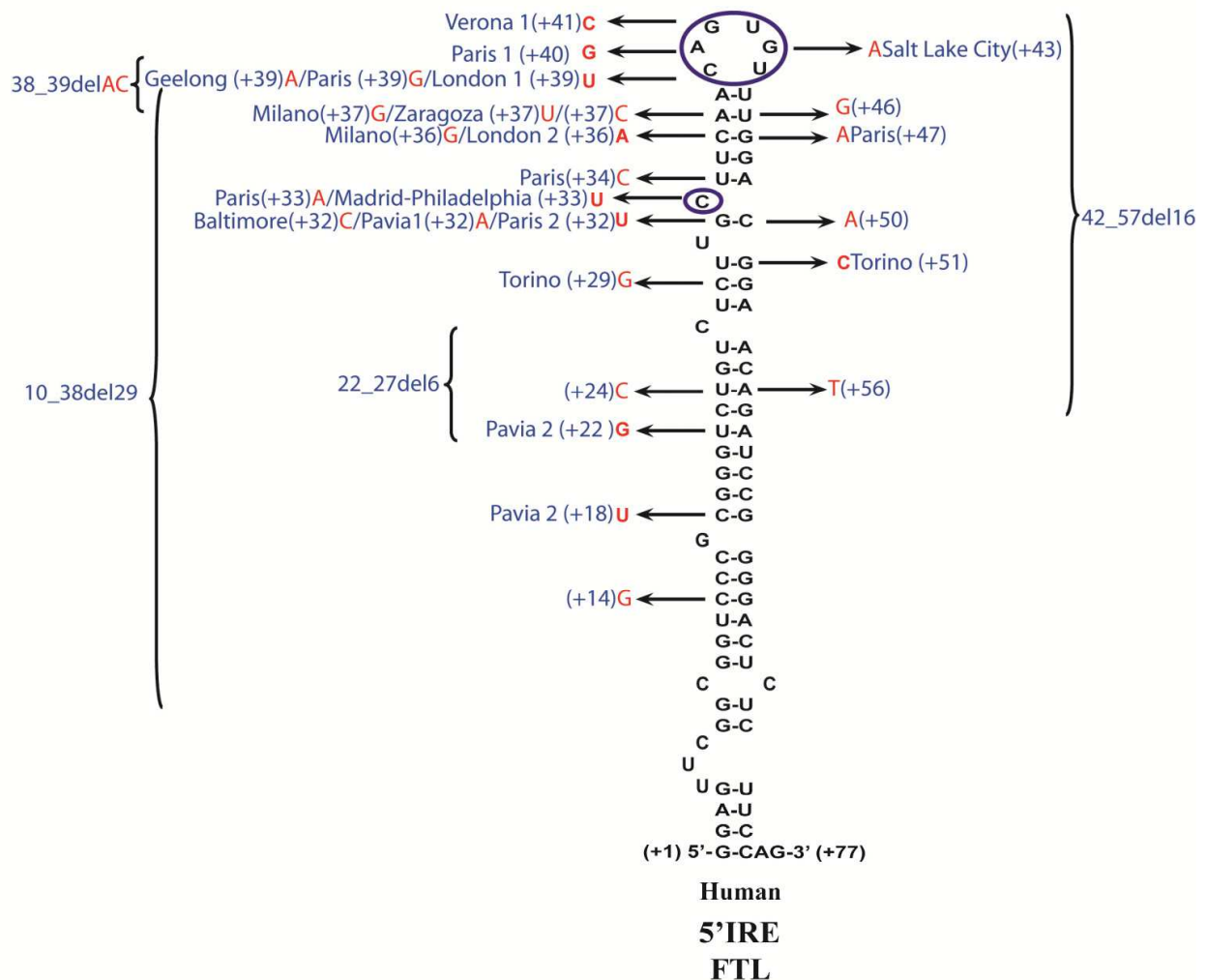

Fig. 6. Predicted secondary structure of the IRE motif in the 5' UTR of the L-ferritin mRNA and reported mutations causing HHCS (name and position in blue and nucleotide change in red). The apical loop and the C8-bulge are circled in blue. The transcriptional start site is shown as (+1), and the first 77 nucleotides are shown in an extended stem-loop structure. Single nucleotide changes are depicted by arrows and nucleotide deletions are represented by brackets.

In HHCS patients there is a marked phenotypic variability with regard to ocular involvement, serum ferritin levels and age of cataract onset, even between subjects sharing the same mutation in the same family. This suggests that other environmental factors could be involved in the development of clinical symptoms in each person (Girelli et al., 2001). Although HHCS is an autosomal dominant disorder, a patient without family history has recently been reported (Cao et al., 2010).

Because of the high levels of serum ferritin, some HHCS patients have been misdiagnosed with the iron-overload genetic disease Hereditary Hemochromatosis. These HHCS patients have been studied by liver biopsy and have developed iron-deficiency anemia after repeated venesections. A correct genetic diagnosis in HHCS patients is very important, as it will prevent unnecessary clinical tests and the implementation of inadequate treatments. For this reason, it is important to increase awareness of this rare pathology among pediatricians,

ophthalmologists, gastroenterologists, haematologists and general practitioners. Patients diagnosed with HHCS should be counselled regarding the relative harmlessness of this genetic disease, with early cataract surgery as the only clinical consequence.

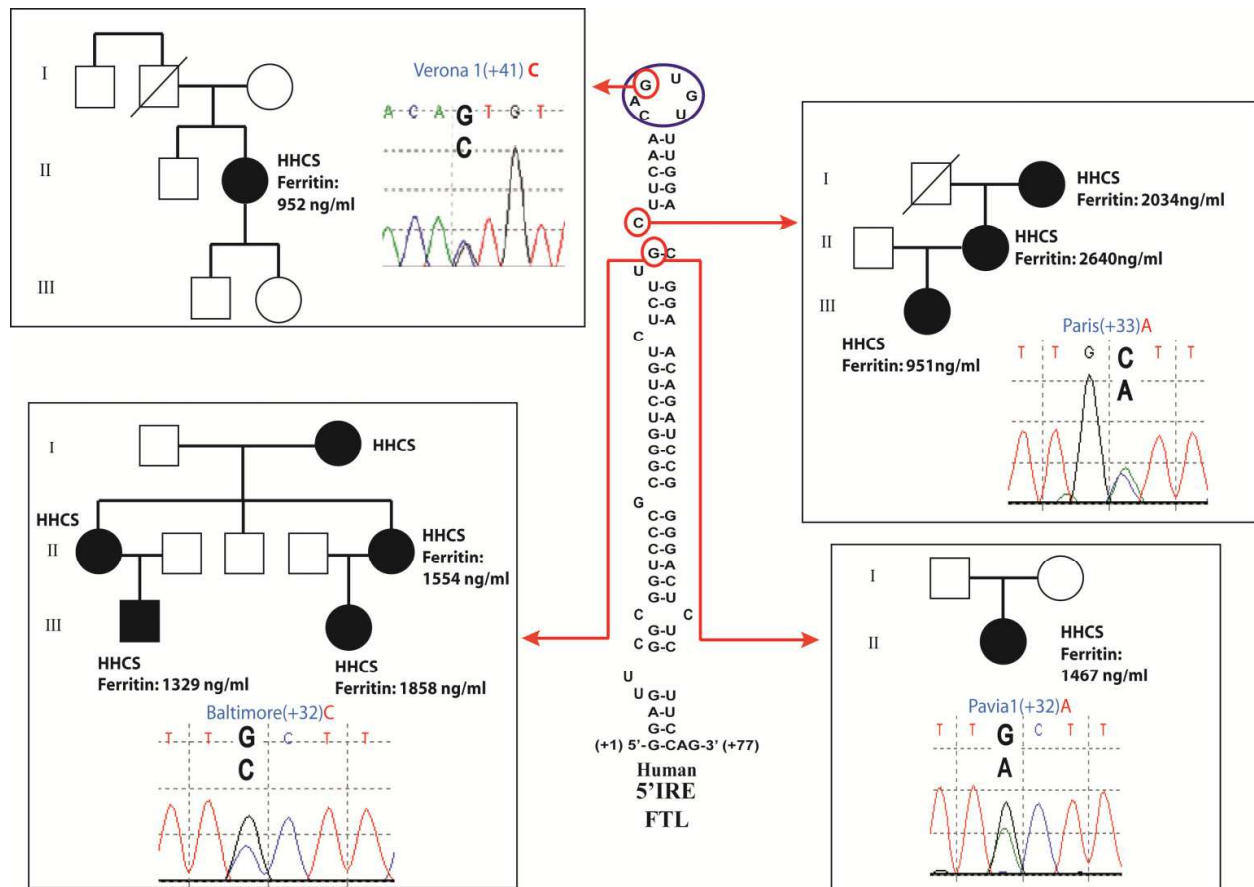

Fig. 7. Four Spanish families affected by hyperferritinemia-cataract syndrome reported in our laboratory. Family pedigrees are shown together with histograms reporting the nucleotide change and the mutation name and position. In the pedigrees, squares and circles symbolize males and females, respectively, and black symbols denote affected patients with hyperferritinemia and cataracts. Serum ferritin (ng/ml) values are indicated in affected individuals. Dashed symbols represent deceased individuals. Roman numerals indicate generations. Point mutations are located in the IRE structure of L-ferritin.

3.2 Autosomal dominant iron overload syndrome (OMIM +134770)

An autosomal dominant iron overload syndrome has been described in a unique Japanese family by Kato and colleagues (Kato et al., 2001). In this family a point mutation (A49U) in the IRE of the H-ferritin gene was found. However, no other mutations in the IRE of the H-Ferritin that affects the IRP/IRE binding have been reported by any other researchers, including a large study with subjects presenting abnormal serum ferritin values and abnormal iron status (Cremonesi et al., 2003).

The proband described by Kato and collaborators was a woman showing high serum ferritin levels, iron overload and increased transferrin saturation. Authors also studied seven family members and found that three of them showed an iron overload phenotype

defined by elevated serum iron values and excessive iron deposition in liver and bone marrow evidenced by magnetic resonance imaging. Two of these three relatives also had elevated serum ferritin levels, but the proband's daughter did not (Figure 8A).

After excluding other causes of iron overload, they sequenced H- and L-ferritin cDNAs in the proband. A heterozygous single A-to-U conversion at position 49 inside the IRE was found in the sequence of the H-ferritin gene (see Figure 8B and 8C).

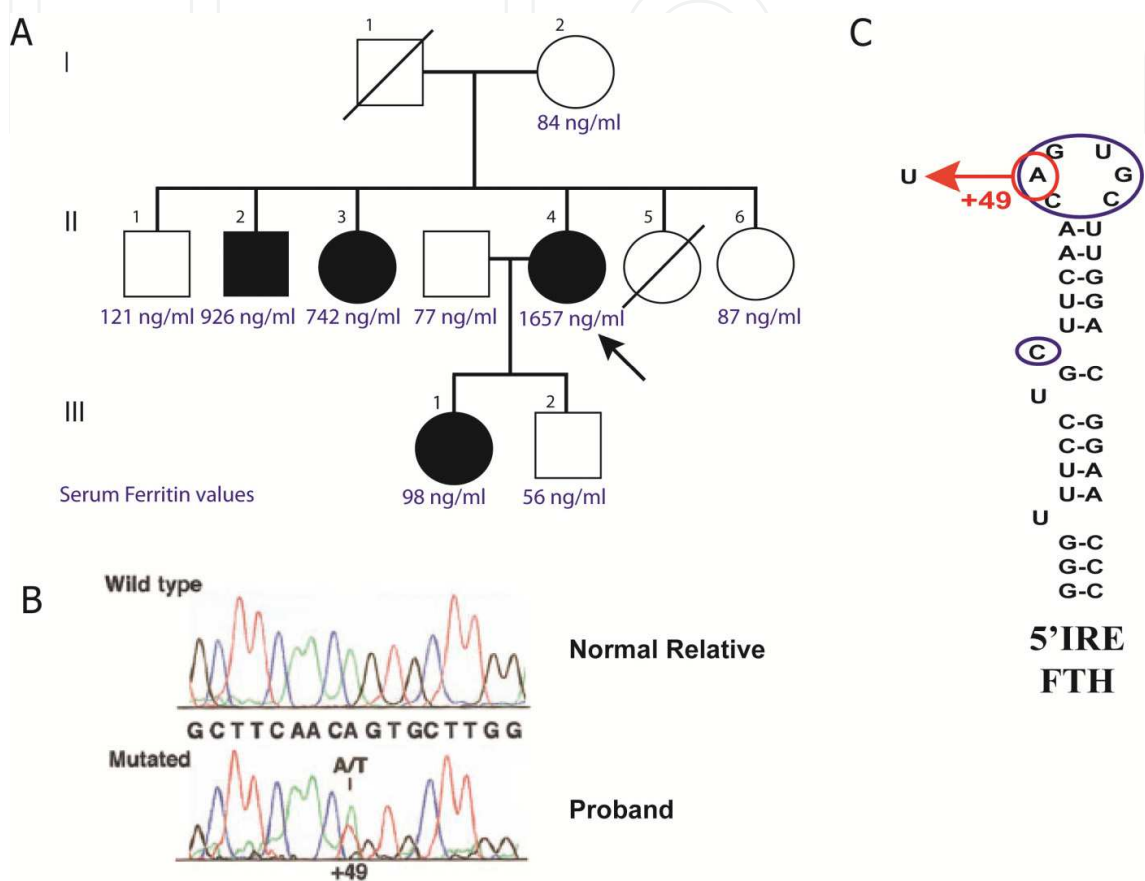

Fig. 8. A mutation in the IRE of H-ferritin mRNA causes autosomal dominant iron overload. A. Pedigree of a family with dominant primary iron overload. Black symbols denote individuals showing the A49T genotype. Serum ferritin (ng/ml) values are indicated. The arrow indicates the proband (II-4). B. Histograms for a normal relative and the proband showing the sequence of H-ferritin where the mutation (+49A>T) was found in heterozygous state. C. Predicted secondary structure of the 5' IRE in H-ferritin subunit mRNA. The mutation position (+49) is based on the human H-ferritin chain mRNA sequence L20941. The A49U mutation affects the second nucleotide of the IRE loop. Adapted from Kato et. al. 2001.

The A49U mutation affects the second base of the IRE apical loop (CAGUG), a nucleotide that was reported to have direct protein contact with IRP1 in the IRP1/IRE crystallography structure (Walden et al., 2006). This mutation was also detected in the genomic DNA of the four relatives who had iron overload, but not in the genomic DNA of 42 unrelated control subjects. The segregation of the mutation and iron overload in the family members was consistent with an autosomal dominant pattern of inheritance. The +49A>T mutation was

considered a novel cause of hereditary iron overload, most likely related to an impairment of the ferroxidase activity generated by H subunit (Kato et al., 2001).

3.3 Mutations in the ferroportin 5' IRE

A radiation-induced mouse model with a 58 bp deletion in the 5' UTR of ferroportin gene, including the IRE motif, has been described (Mok et al., 2004). These mice present erythropoietin-dependent polycythaemia when the mutation is in the heterozygous state and microcytic hypochromic anaemia in homozygosity. Both defects in erythropoiesis were transient and corrected in early adulthood by the action of hepcidin.

A 5' UTR mutation has been detected in a patient with iron overload due to Hereditary Hemochromatosis type 4, also known as ferroportin disease (Liu et al., 2005). The mutation is located seven nucleotides downstream of the ferroportin IRE and may alter the IRE-IRP recognition, although this has not been proven.

3.4 IRPs in iron-sulphur cluster deficiency anaemias

As mentioned in section 2.1.2.1, IRP1 has a dual function; firstly as a cytosolic aconitase when it incorporates an iron-sulphur cluster, and secondly as an RNA-binding protein when this cluster is removed in iron-deprived conditions. The formation and assembly of iron-sulphur clusters in the cell is therefore very important for the regulation of IRP1 activity.

A novel disorder affecting the iron/sulphur cluster biogenesis has been described in a patient with a recessive form of inherited sideroblastic anaemias and a zebrafish model with severe hypochromic anaemia, the *shiraz* mutant (Camaschella et al., 2007; Wingert et al., 2005). Both phenotypes are due to a mutation in the *GLRX5* gene, which encodes for a mitochondrial protein important for iron/sulphur cluster biogenesis. The observed anaemia is the result of *GLRX5* deficiency that increases IRP1 activity in the absence of iron/sulfur clusters which hampers its conversion to an aconitase. Increased IRP1 IRE binding activity leads to *Alas2* translational repression and cytosolic iron depletion that also activates IRP2, which further contributes to *Alas2* blocking. The described patient bears a homozygous mutation that interferes with intron 1 splicing and drastically reduces *GLRX5* mRNA levels. Clinically this patient presents with iron overload and mild sideroblastic anaemia (Camaschella et al., 2007). Surprisingly, the anaemia in the patient was worsened by blood transfusions but partially reversed by iron chelation, presumably because iron chelation will redistribute iron to the cytosol, which might decrease IRP2 excess, improving haem synthesis and anaemia. The discovery of this disease establishes a link between two pathways of mitochondria iron utilization: haem biosynthesis and iron/sulphur cluster biogenesis.

X-linked sideroblastic anaemia with ataxia (XLSA/A) is another disease affecting the iron/sulphur cluster (ISC) pathway. XLSA/A is a rare inherited disorder characterized by mild anaemia and ataxia and is caused by mutations in the *ABCB7* gene, which encodes a member of the ATP-binding cassette transporter family involved in the transport of ISC from the mitochondria to the cytoplasm. The liver-specific conditional knockout of *Abcb7* results in strong decrease of cytosolic aconitase activity and a 6-fold reciprocal increase in

IRP1 RNA binding activity, with concomitant increase in TFR1 expression and hepatic iron overload (Pondarre et al., 2006). However, increased levels of TFR1 proteins were attributed to IRP2 stabilizing effects rather than IRP1, as surprisingly it was found that IRP1 protein levels were reduced in these mice due to an iron-dependent IRP1 protein degradation. RNA binding activity and protein levels of IRP2 were found to increase, despite the apparent cellular iron overload that does not seem to be appropriately sensed by IRP2.

In conclusion, ISC deficiency leads to dysregulated activation of IRP1 and IRP2 and it seems that IRP RNA binding activity may respond more to the flux of iron through a specific metabolic pathway, such as the ISC assembly, than to the absolute levels of cellular iron. Therefore, major problems associated with these disorders seem to be a consequence of inappropriate regulation of downstream targets of cytosolic IRPs, rather than ISC deficiency *per se*.

3.5 Other pathophysiological roles for IRPs

Brain homeostasis of trace metals such as copper and iron is dysregulated in neurological disorders such as Alzheimer's disease, where increased iron and decreased copper levels are observed. Young mice with targeted deletion of IRP2 have significantly less brain copper and the expression of β -APP is significantly up-regulated in the hippocampus (Mueller et al., 2009). In humans, polymorphisms in the promoter region of IRP2 gene are statistically associated with Alzheimer's disease (Coon et al., 2006). This finding awaits further confirmation in independent and larger studies, and also the functional significance of these polymorphisms needs to be clarified. Mouse work on the role of IRP2 in neuropathology is somewhat controversial. One group have reported that aging IRP2 KO mice develop a progressive neurodegenerative disorder (LaVaute et al., 2001), while the IRP2 KO mice generated by an independent group using a different targeting strategy do not manifest severe neurodegeneration, despite performing poorly in neurobehavioural tests (Galy et al., 2006). In spite of the observed iron accumulation in the neurons of the substantia nigra of Parkinson's patients, ferritin levels are not up-regulated. This effect was attributed to high levels of IRP1-IRE binding activity, which is insensitive to iron concentration, probably because of a different compartmentalization of the iron (Faucheux et al., 2002). IRP-1 and -2 activities were found to be increased in brain cells in a Transmissible Spongiform Encephalopathy mouse model (Kim et al., 2007).

Genome-wide association studies in combination with expression profiling implicate IRP2 as a susceptibility gene in chronic obstructive pulmonary disease (COPD) (DeMeo et al., 2009). This study also found that IRP2 protein and mRNA were increased in lung-tissue samples from COPD subjects in comparison with controls. The association of IRP2 SNPs with COPD has been recently replicated by a second group (Chappell et al., 2011).

IRPs have been involved in cancer biology. The over-expression of IRP1 suppresses growth of tumour xenografts in nude mice (Chen et al., 2007). In these experiments, stable transfected and tetracycline inducible (tet-off system) H1299 lung cancer cells with IRP1 wild-type or a mutated IRP1 version that constitutively binds IRE were used; these cells and control cells were then transplanted into nude mice to study their tumourigenic effects. Interestingly, similar experiments with IRP2 showed the opposite behaviour, a pro-oncogenic activity of the over-expression of IRP2 that was attributed to an IRP2-specific

domain of 73 amino acids (Maffettone et al., 2010). In both systems the expression of ferritin and TFR1 was similar; however, tumours over-expressing IRP1 and IRP2 exhibited distinct gene-expression profiles, suggesting that IRPs may differentially modulate cancer growth by regulating a different subset of genes, which could be related or not to iron homeostasis. Indeed, the IRP2 pro-oncogenic activity was associated with an increase in the phosphorylation of ERK 1/2, an extracellular signal-regulated kinase, and with high levels of the proto-oncogene c-myc that was previously implicated in the transcriptional activation of IRP2 (Wu et al., 1999). The understanding of the molecular pathways that involves IRPs in cancer biology is very incipient and further work is required.

4. Small molecules and drugs affecting the IRP/IRE regulatory network

Small-molecules that selectively bind to and modulate the IRP-IRE interaction, by inhibiting or enhancing it, have been described in two studies.

By chemical footprinting assay the natural product yohimbine was found to selectively interfere with the ferritin IRE and inhibit IRP-ferritin IRE binding, increasing the rate of ferritin biosynthesis in cell-free extracts (Tibodeau et al., 2006). The selective effect of this compound proved that small-molecules can distinguish between different members of the IRE family. Further development of therapeutic approaches, with this or similar compounds, could be used to increase iron-storage capacity in pathological conditions that require it, such as iron-overload diseases.

Using a cell-based screen method several small molecules that decrease HIF2 α translation by enhancing the binding of preferentially IRP1 to the 5' IRE present in HIF2 α were described by Zimmer and collaborators (Zimmer et al., 2008). An enhancer effect of these compounds on the IRP-IRE binding was also observed for transferrin receptor 1 (TFR1), increasing its mRNA stability. As hypoxia inducible factors (HIFs) are linked to cancer progression, angiogenesis and inflammation, HIF inhibitors (like these compounds) could be used in antineoplastic and anti-inflammatory therapies.

Other small molecules and drugs that interfere with iron uptake via DMT1 or transferrin receptor 1 have been reported but their mechanism of action does not seem to be related with the modulation of the IRP-IRE regulatory system (Brown et al., 2004; Horonchik & Wessling-Resnick, 2008; Wetli et al., 2006).

5. Conclusions and future perspectives

In recent years, impressive progress has been made in unraveling the control of iron homeostasis by the IRP/IRE regulatory system. However, many details remain unanswered and require further investigation. For instance, a recent high-throughput screening study has considerably enlarged the number of known IRP-binding mRNAs, extending the IRP functions to multiple pathways, including cancer biology (Sanchez et al., 2011). Now the challenge is to uncover the role and mechanisms of action of these new mRNAs regulated by IRPs with studies ranging from basic research to medical and applied physiology.

Additional IRP mouse models with cell-specific ablation or over-expression in an inducible or non-inducible system will provide valuable information concerning the pathophysiological role of IRPs. To elucidate the specific role of mRNA isoforms containing

an IRE and the physiological role that IRPs exert on them *in vivo*, the generation of animal models with a particular disrupted IRE would be of great interest. A deeper study into several research fields affecting iron and IRP misregulation (such as iron brain homeostasis, iron in cancer biology and iron implication in immunity and infection) will have implications for the development of therapies for common and rare disorders related to the IRP/IRE regulatory system.

6. Acknowledgements

Dr. Mayka Sanchez's group is supported by by 'Instituto de Salud Carlos III', Spanish Health Program (Ministry of Science and Innovation; PS09/00341); Spanish Ministry of Science and Innovation (RYC-2008-02352 research contract under the Ramon y Cajal program). Dr. Mayka Sanchez's group was also awarded with a European Union programme for research in rare diseases (ERA-Net on rare diseases) project, ERARE-115, HMA-IRON, co-ordinated by Dr. Carole Beaumont.

7. References

- Alen, C., & Sonenshein, A. L. (1999). Bacillus subtilis aconitase is an RNA-binding protein. *Proc Natl Acad Sci U S A*, 96(18), 10412-10417.
- Andrews, N. C. (2010). Ferritin(in)g out new mechanisms in iron homeostasis. *Cell Metab*, 12(3), 203-204.
- Arosio, P., Ingrassia, R., & Cavadini, P. (2009). Ferritins: a family of molecules for iron storage, antioxidation and more. *Biochim Biophys Acta*, 1790(7), 589-599.
- Bengert, P., & Dandekar, T. (2003). A software tool-box for analysis of regulatory RNA elements. *Nucleic Acids Res*, 31(13), 3441-3445.
- Bianchi, L., Tacchini, L., & Cairo, G. (1999). HIF-1-mediated activation of transferrin receptor gene transcription by iron chelation. *Nucleic Acids Res*, 27(21), 4223-4227.
- Binder, R., Horowitz, J. A., Basilion, J. P., et al. (1994). Evidence that the pathway of transferrin receptor mRNA degradation involves an endonucleolytic cleavage within the 3' UTR and does not involve poly(A) tail shortening. *EMBO J*, 13(8), 1969-1980.
- Bonneau, D., Winter-Fuseau, I., Loiseau, M. N., et al. (1995). Bilateral cataract and high serum ferritin: a new dominant genetic disorder? *J Med Genet*, 32(10), 778-779.
- Brazzolotto, X., Andriollo, M., Guiraud, P., et al. (2003). Interactions between doxorubicin and the human iron regulatory system. *Biochim Biophys Acta*, 1593(2-3), 209-218.
- Brown, J. X., Buckett, P. D., & Wessling-Resnick, M. (2004). Identification of small molecule inhibitors that distinguish between non-transferrin bound iron uptake and transferrin-mediated iron transport. *Chem Biol*, 11(3), 407-416.
- Butt, J., Kim, H. Y., Basilion, J. P., et al. (1996). Differences in the RNA binding sites of iron regulatory proteins and potential target diversity. *Proc Natl Acad Sci U S A*, 93(9), 4345-4349.
- Cairo, G., & Pietrangelo, A. (1994). Transferrin receptor gene expression during rat liver regeneration. Evidence for post-transcriptional regulation by iron regulatory factor B, a second iron-responsive element-binding protein. *J Biol Chem*, 269(9), 6405-6409.
- Cairo, G., & Pietrangelo, A. (2000). Iron regulatory proteins in pathobiology. *Biochem J*, 352 Pt 2, 241-250.

- Caltagirone, A., Weiss, G., & Pantopoulos, K. (2001). Modulation of cellular iron metabolism by hydrogen peroxide. Effects of H₂O₂ on the expression and function of iron-responsive element-containing mRNAs in B6 fibroblasts. *J Biol Chem*, 276(23), 19738-19745.
- Camaschella, C., Campanella, A., De Falco, L., et al. (2007). The human counterpart of zebrafish shiraz shows sideroblastic-like microcytic anemia and iron overload. *Blood*, 110(4), 1353-1358.
- Campillos, M., Cases, I., Hentze, M. W., et al. (2010). SIREs: searching for iron-responsive elements. *Nucleic Acids Res*, 38 Suppl, W360-367.
- Cao, W., McMahon, M., Wang, B., et al. (2010). A case report of spontaneous mutation (C33>U) in the iron-responsive element of L-ferritin causing hyperferritinemia-cataract syndrome. *Blood Cells Mol Dis*, 44(1), 22-27.
- Cazzola, M., Bergamaschi, G., Tonon, L., et al. (1997). Hereditary hyperferritinemia-cataract syndrome: relationship between phenotypes and specific mutations in the iron-responsive element of ferritin light-chain mRNA. *Blood*, 90(2), 814-821.
- Cmejla, R., Petrak, J., & Cmejlova, J. (2006). A novel iron responsive element in the 3'UTR of human MRCKalpha. *Biochem Biophys Res Commun*, 341(1), 158-166.
- Coon, K. D., Siegel, A. M., Yee, S. J., et al. (2006). Preliminary demonstration of an allelic association of the IREB2 gene with Alzheimer's disease. *J Alzheimers Dis*, 9(3), 225-233.
- Craig, J. E., Clark, J. B., McLeod, J. L., et al. (2003). Hereditary hyperferritinemia-cataract syndrome: prevalence, lens morphology, spectrum of mutations, and clinical presentations. *Arch Ophthalmol*, 121(12), 1753-1761.
- Cremonesi, L., Foglieni, B., Fermo, I., et al. (2003). Identification of two novel mutations in the 5'-untranslated region of H-ferritin using denaturing high performance liquid chromatography scanning. *Haematologica*, 88(10), 1110-1116.
- Crichton, R. R. (2009). *Iron metabolism : from molecular mechanisms to clinical consequences* (3rd ed.). Chichester, UK: John Wiley & Sons.
- Chappell, S. L., Daly, L., Lotya, J., et al. (2011). The role of IREB2 and transforming growth factor beta-1 genetic variants in COPD: a replication case-control study. *BMC Med Genet*, 12, 24.
- Chen, G., Fillebeen, C., Wang, J., et al. (2007). Overexpression of iron regulatory protein 1 suppresses growth of tumor xenografts. *Carcinogenesis*, 28(4), 785-791.
- Dandekar, T., Stripecke, R., Gray, N. K., et al. (1991). Identification of a novel iron-responsive element in murine and human erythroid delta-aminolevulinic acid synthase mRNA. *EMBO J*, 10(7), 1903-1909.
- De Domenico, I., Ward, D. M., & Kaplan, J. (2007). Hepcidin regulation: ironing out the details. *J Clin Invest*, 117(7), 1755-1758.
- Delaby, C., Pilard, N., Puy, H., et al. (2008). Sequential regulation of ferroportin expression after erythrophagocytosis in murine macrophages: early mRNA induction by haem, followed by iron-dependent protein expression. *Biochem J*, 411(1), 123-131.
- DeMeo, D. L., Mariani, T., Bhattacharya, S., et al. (2009). Integration of genomic and genetic approaches implicates IREB2 as a COPD susceptibility gene. *Am J Hum Genet*, 85(4), 493-502.
- Donovan, A., Brownlie, A., Dorschner, M. O., et al. (2002). The zebrafish mutant gene chardonnay (cdy) encodes divalent metal transporter 1 (DMT1). *Blood*, 100(13), 4655-4659.

- Donovan, A., Lima, C. A., Pinkus, J. L., et al. (2005). The iron exporter ferroportin/Slc40a1 is essential for iron homeostasis. *Cell Metab*, 1(3), 191-200.
- Drakesmith, H., & Prentice, A. (2008). Viral infection and iron metabolism. *Nat Rev Microbiol*, 6(7), 541-552.
- Drapier, J. C. (1997). Interplay between NO and [Fe-S] clusters: relevance to biological systems. *Methods*, 11(3), 319-329.
- Eisenstein, R. S. (2000). Iron regulatory proteins and the molecular control of mammalian iron metabolism. *Annu Rev Nutr*, 20, 627-662.
- Faucheux, B. A., Martin, M. E., Beaumont, C., et al. (2002). Lack of up-regulation of ferritin is associated with sustained iron regulatory protein-1 binding activity in the substantia nigra of patients with Parkinson's disease. *J Neurochem*, 83(2), 320-330.
- Ferreira, C., Bucchini, D., Martin, M. E., et al. (2000). Early embryonic lethality of H ferritin gene deletion in mice. *J Biol Chem*, 275(5), 3021-3024.
- Fillebeen, C., Muckenthaler, M., Andriopoulos, B., et al. (2007). Expression of the subgenomic hepatitis C virus replicon alters iron homeostasis in Huh7 cells. *J Hepatol*, 47(1), 12-22.
- Fleming, M. D., Romano, M. A., Su, M. A., et al. (1998). Nramp2 is mutated in the anemic Belgrade (b) rat: evidence of a role for Nramp2 in endosomal iron transport. *Proc Natl Acad Sci U S A*, 95(3), 1148-1153.
- Fleming, M. D., Trenor, C. C., 3rd, Su, M. A., et al. (1997). Microcytic anaemia mice have a mutation in Nramp2, a candidate iron transporter gene. *Nat Genet*, 16(4), 383-386.
- Friedlich, A. L., Tanzi, R. E., & Rogers, J. T. (2007). The 5'-untranslated region of Parkinson's disease alpha-synuclein messengerRNA contains a predicted iron responsive element. *Mol Psychiatry*, 12(3), 222-223.
- Galy, B., Ferring-Appel, D., Kaden, S., et al. (2008). Iron regulatory proteins are essential for intestinal function and control key iron absorption molecules in the duodenum. *Cell Metab*, 7(1), 79-85.
- Galy, B., Ferring-Appel, D., Sauer, S. W., et al. (2010). Iron regulatory proteins secure mitochondrial iron sufficiency and function. *Cell Metab*, 12(2), 194-201.
- Galy, B., Holter, S. M., Klopstock, T., et al. (2006). Iron homeostasis in the brain: complete iron regulatory protein 2 deficiency without symptomatic neurodegeneration in the mouse. *Nat Genet*, 38(9), 967-969; discussion 969-970.
- Ganz, T., & Nemeth, E. (2011). Hepcidin and disorders of iron metabolism. *Annu Rev Med*, 62, 347-360.
- Gao, J., Lovejoy, D., & Richardson, D. R. (1999). Effect of iron chelators with potent anti-proliferative activity on the expression of molecules involved in cell cycle progression and growth. *Redox Rep*, 4(6), 311-312.
- Girelli, D., Bozzini, C., Zecchina, G., et al. (2001). Clinical, biochemical and molecular findings in a series of families with hereditary hyperferritinaemia-cataract syndrome. *Br J Haematol*, 115(2), 334-340.
- Girelli, D., Olivieri, O., De Franceschi, L., et al. (1995). A linkage between hereditary hyperferritinaemia not related to iron overload and autosomal dominant congenital cataract. *Br J Haematol*, 90(4), 931-934.
- Goforth, J. B., Anderson, S. A., Nizzi, C. P., et al. (2010). Multiple determinants within iron-responsive elements dictate iron regulatory protein binding and regulatory hierarchy. *RNA*, 16(1), 154-169.

- Gray, N. K., Pantopoulos, K., Dandekar, T., et al. (1996). Translational regulation of mammalian and *Drosophila* citric acid cycle enzymes via iron-responsive elements. *Proc Natl Acad Sci U S A*, 93(10), 4925-4930.
- Gu, J. M., Lim, S. O., Oh, S. J., et al. (2008). HBx modulates iron regulatory protein 1-mediated iron metabolism via reactive oxygen species. *Virus Res*, 133(2), 167-177.
- Hausmann, A., Lee, J., & Pantopoulos, K. (2011). Redox control of iron regulatory protein 2 stability. *FEBS Lett*, 585(4), 687-692.
- Henderson, B. R., Menotti, E., & Kuhn, L. C. (1996). Iron regulatory proteins 1 and 2 bind distinct sets of RNA target sequences. *J Biol Chem*, 271(9), 4900-4908.
- Henderson, B. R., Seiser, C., & Kuhn, L. C. (1993). Characterization of a second RNA-binding protein in rodents with specificity for iron-responsive elements. *J Biol Chem*, 268(36), 27327-27334.
- Hentze, M. W., Muckenthaler, M. U., Galy, B., et al. (2010). Two to tango: regulation of Mammalian iron metabolism. *Cell*, 142(1), 24-38.
- Horonchik, L., & Wessling-Resnick, M. (2008). The small-molecule iron transport inhibitor ferristatin/NSC306711 promotes degradation of the transferrin receptor. *Chem Biol*, 15(7), 647-653.
- Hubert, N., & Hentze, M. W. (2002). Previously uncharacterized isoforms of divalent metal transporter (DMT)-1: implications for regulation and cellular function. *Proc Natl Acad Sci U S A*, 99(19), 12345-12350.
- Iwai, K., Drake, S. K., Wehr, N. B., et al. (1998). Iron-dependent oxidation, ubiquitination, and degradation of iron regulatory protein 2: implications for degradation of oxidized proteins. *Proc Natl Acad Sci U S A*, 95(9), 4924-4928.
- Kannengiesser, C., Jouanolle, A. M., Hetet, G., et al. (2009). A new missense mutation in the L ferritin coding sequence associated with elevated levels of glycosylated ferritin in serum and absence of iron overload. *Haematologica*, 94(3), 335-339.
- Kato, J., Fujikawa, K., Kanda, M., et al. (2001). A mutation, in the iron-responsive element of H ferritin mRNA, causing autosomal dominant iron overload. *Am J Hum Genet*, 69(1), 191-197.
- Kim, B. H., Jun, Y. C., Jin, J. K., et al. (2007). Alteration of iron regulatory proteins (IRP1 and IRP2) and ferritin in the brains of scrapie-infected mice. *Neurosci Lett*, 422(3), 158-163.
- Kim, S., & Ponka, P. (2002). Nitric oxide-mediated modulation of iron regulatory proteins: implication for cellular iron homeostasis. *Blood Cells Mol Dis*, 29(3), 400-410.
- Kim, S., Wing, S. S., & Ponka, P. (2004). S-nitrosylation of IRP2 regulates its stability via the ubiquitin-proteasome pathway. *Mol Cell Biol*, 24(1), 330-337.
- Kohler, S. A., Menotti, E., & Kuhn, L. C. (1999). Molecular cloning of mouse glycolate oxidase. High evolutionary conservation and presence of an iron-responsive element-like sequence in the mRNA. *J Biol Chem*, 274(4), 2401-2407.
- Kwok, J. C., & Richardson, D. R. (2002). Unexpected anthracycline-mediated alterations in iron-regulatory protein-RNA-binding activity: the iron and copper complexes of anthracyclines decrease RNA-binding activity. *Mol Pharmacol*, 62(4), 888-900.
- LaVaute, T., Smith, S., Cooperman, S., et al. (2001). Targeted deletion of the gene encoding iron regulatory protein-2 causes misregulation of iron metabolism and neurodegenerative disease in mice. *Nat Genet*, 27(2), 209-214.
- Leedman, P. J., Stein, A. R., Chin, W. W., et al. (1996). Thyroid hormone modulates the interaction between iron regulatory proteins and the ferritin mRNA iron-responsive element. *J Biol Chem*, 271(20), 12017-12023.

- Levy, J. E., Jin, O., Fujiwara, Y., et al. (1999). Transferrin receptor is necessary for development of erythrocytes and the nervous system. *Nat Genet*, 21(4), 396-399.
- Lin, E., Graziano, J. H., & Freyer, G. A. (2001). Regulation of the 75-kDa subunit of mitochondrial complex I by iron. *J Biol Chem*, 276(29), 27685-27692.
- Liu, W., Shimomura, S., Imanishi, H., et al. (2005). Hemochromatosis with mutation of the ferroportin 1 (IREG1) gene. *Intern Med*, 44(4), 285-289.
- Liu, X. B., Hill, P., & Haile, D. J. (2002). Role of the ferroportin iron-responsive element in iron and nitric oxide dependent gene regulation. *Blood Cells Mol Dis*, 29(3), 315-326.
- Lok, C. N., & Ponka, P. (2000). Identification of an erythroid active element in the transferrin receptor gene. *J Biol Chem*, 275(31), 24185-24190.
- Lymboussaki, A., Pignatti, E., Montosi, G., et al. (2003). The role of the iron responsive element in the control of ferroportin1/IREG1/MTP1 gene expression. *J Hepatol*, 39(5), 710-715.
- Macke, T. J., Ecker, D. J., Gutell, R. R., et al. (2001). RNAMotif, an RNA secondary structure definition and search algorithm. *Nucleic Acids Res*, 29(22), 4724-4735.
- Mackenzie, B., & Garrick, M. D. (2005). Iron Imports. II. Iron uptake at the apical membrane in the intestine. *Am J Physiol Gastrointest Liver Physiol*, 289(6), G981-986.
- Maffettone, C., Chen, G., Drozdov, I., et al. (2010). Tumorigenic properties of iron regulatory protein 2 (IRP2) mediated by its specific 73-amino acids insert. *PLoS One*, 5(4), e10163.
- Maffettone, C., De Martino, L., Irace, C., et al. (2008). Expression of iron-related proteins during infection by bovine herpes virus type-1. *J Cell Biochem*, 104(1), 213-223.
- Mastrogiannaki, M., Matak, P., Keith, B., et al. (2009). HIF-2alpha, but not HIF-1alpha, promotes iron absorption in mice. *J Clin Invest*, 119(5), 1159-1166.
- Mattace Raso, G., Irace, C., Esposito, E., et al. (2009). Ovariectomy and estrogen treatment modulate iron metabolism in rat adipose tissue. *Biochem Pharmacol*, 78(8), 1001-1007.
- Meehan, H. A., & Connell, G. J. (2001). The hairpin loop but not the bulged C of the iron responsive element is essential for high affinity binding to iron regulatory protein-1. *J Biol Chem*, 276(18), 14791-14796.
- Meyron-Holtz, E. G., Ghosh, M. C., & Rouault, T. A. (2004). Mammalian tissue oxygen levels modulate iron-regulatory protein activities in vivo. *Science*, 306(5704), 2087-2090.
- Mignone, F., Grillo, G., Licciulli, F., et al. (2005). UTRdb and UTRsite: a collection of sequences and regulatory motifs of the untranslated regions of eukaryotic mRNAs. *Nucleic Acids Res*, 33(Database issue), D141-146.
- Millonig, G., Muckenthaler, M. U., & Mueller, S. (2010). Hyperferritinaemia-cataract syndrome: worldwide mutations and phenotype of an increasingly diagnosed genetic disorder. *Hum Genomics*, 4(4), 250-262.
- Minotti, G., Ronchi, R., Salvatorelli, E., et al. (2001). Doxorubicin irreversibly inactivates iron regulatory proteins 1 and 2 in cardiomyocytes: evidence for distinct metabolic pathways and implications for iron-mediated cardiotoxicity of antitumor therapy. *Cancer Res*, 61(23), 8422-8428.
- Mok, H., Jelinek, J., Pai, S., et al. (2004). Disruption of ferroportin 1 regulation causes dynamic alterations in iron homeostasis and erythropoiesis in polycythaemia mice. *Development*, 131(8), 1859-1868.
- Muckenthaler, M., Gray, N. K., & Hentze, M. W. (1998). IRP-1 binding to ferritin mRNA prevents the recruitment of the small ribosomal subunit by the cap-binding complex eIF4F. *Mol Cell*, 2(3), 383-388.

- Muckenthaler, M. U., Galy, B., & Hentze, M. W. (2008). Systemic iron homeostasis and the iron-responsive element/iron-regulatory protein (IRE/IRP) regulatory network. *Annu Rev Nutr*, 28, 197-213.
- Mueller, C., Magaki, S., Schrag, M., et al. (2009). Iron regulatory protein 2 is involved in brain copper homeostasis. *J Alzheimers Dis*, 18(1), 201-210.
- Mulero, V., & Brock, J. H. (1999). Regulation of iron metabolism in murine J774 macrophages: role of nitric oxide-dependent and -independent pathways following activation with gamma interferon and lipopolysaccharide. *Blood*, 94(7), 2383-2389.
- Mutze, S., Hebling, U., Stremmel, W., et al. (2003). Myeloperoxidase-derived hypochlorous acid antagonizes the oxidative stress-mediated activation of iron regulatory protein 1. *J Biol Chem*, 278(42), 40542-40549.
- Nemeth, E., Tuttle, M. S., Powelson, J., et al. (2004). Hepcidin regulates cellular iron efflux by binding to ferroportin and inducing its internalization. *Science*, 306(5704), 2090-2093.
- Nurtjahja-Tjendraputra, E., Fu, D., Phang, J. M., et al. (2007). Iron chelation regulates cyclin D1 expression via the proteasome: a link to iron deficiency-mediated growth suppression. *Blood*, 109(9), 4045-4054.
- O'Donnell, K. A., Yu, D., Zeller, K. I., et al. (2006). Activation of transferrin receptor 1 by c-Myc enhances cellular proliferation and tumorigenesis. *Mol Cell Biol*, 26(6), 2373-2386.
- Pantopoulos, K., & Hentze, M. W. (1995). Nitric oxide signaling to iron-regulatory protein: direct control of ferritin mRNA translation and transferrin receptor mRNA stability in transfected fibroblasts. *Proc Natl Acad Sci U S A*, 92(5), 1267-1271.
- Pondarre, C., Antiochos, B. B., Campagna, D. R., et al. (2006). The mitochondrial ATP-binding cassette transporter Abcb7 is essential in mice and participates in cytosolic iron-sulfur cluster biogenesis. *Hum Mol Genet*, 15(6), 953-964.
- Ponka, P., Beaumont, C., & Richardson, D. R. (1998). Function and regulation of transferrin and ferritin. *Semin Hematol*, 35(1), 35-54.
- Recalcati, S., Conte, D., & Cairo, G. (1999). Preferential activation of iron regulatory protein-2 in cell lines as a result of higher sensitivity to iron. *Eur J Biochem*, 259(1-2), 304-309.
- Recalcati, S., Minotti, G., & Cairo, G. (2010). Iron regulatory proteins: from molecular mechanisms to drug development. *Antioxid Redox Signal*, 13(10), 1593-1616.
- Rogers, J. T., Randall, J. D., Cahill, C. M., et al. (2002). An iron-responsive element type II in the 5'-untranslated region of the Alzheimer's amyloid precursor protein transcript. *J Biol Chem*, 277(47), 45518-45528.
- Rouault, T. A. (2006). The role of iron regulatory proteins in mammalian iron homeostasis and disease. *Nat Chem Biol*, 2(8), 406-414.
- Salahudeen, A. A., Thompson, J. W., Ruiz, J. C., et al. (2009). An E3 Ligase Possessing an Iron Responsive Hemerythrin Domain Is a Regulator of Iron Homeostasis. *Science*.
- Sanchez, M., Galy, B., Dandekar, T., et al. (2006). Iron regulation and the cell cycle: identification of an iron-responsive element in the 3'-untranslated region of human cell division cycle 14A mRNA by a refined microarray-based screening strategy. *J Biol Chem*, 281(32), 22865-22874.
- Sanchez, M., Galy, B., Muckenthaler, M. U., et al. (2007). Iron-regulatory proteins limit hypoxia-inducible factor-2alpha expression in iron deficiency. *Nat Struct Mol Biol*, 14(5), 420-426.

- Sanchez, M., Galy, B., Schwanhaeuser, B., et al. (2011). Iron regulatory protein-1 and -2: transcriptome-wide definition of binding mRNAs and shaping of the cellular proteome by IRPs. *Blood*, *In press*.
- Schalinske, K. L., Chen, O. S., & Eisenstein, R. S. (1998). Iron differentially stimulates translation of mitochondrial aconitase and ferritin mRNAs in mammalian cells. Implications for iron regulatory proteins as regulators of mitochondrial citrate utilization. *J Biol Chem*, *273*(6), 3740-3746.
- Smith, S. R., Ghosh, M. C., Ollivierre-Wilson, H., et al. (2006). Complete loss of iron regulatory proteins 1 and 2 prevents viability of murine zygotes beyond the blastocyst stage of embryonic development. *Blood Cells Mol Dis*, *36*(2), 283-287.
- Tibodeau, J. D., Fox, P. M., Ropp, P. A., et al. (2006). The up-regulation of ferritin expression using a small-molecule ligand to the native mRNA. *Proc Natl Acad Sci U S A*, *103*(2), 253-257.
- Vanoaica, L., Darshan, D., Richman, L., et al. (2010). Intestinal ferritin H is required for an accurate control of iron absorption. *Cell Metab*, *12*(3), 273-282.
- Vashisht, A. A., Zumbrennen, K. B., Huang, X., et al. (2009). Control of Iron Homeostasis by an Iron-Regulated Ubiquitin Ligase. *Science*.
- Walden, W. E., Selezneva, A. I., Dupuy, J., et al. (2006). Structure of dual function iron regulatory protein 1 complexed with ferritin IRE-RNA. *Science*, *314*(5807), 1903-1908.
- Wallander, M. L., Leibold, E. A., & Eisenstein, R. S. (2006). Molecular control of vertebrate iron homeostasis by iron regulatory proteins. *Biochim Biophys Acta*, *1763*(7), 668-689.
- Wallander, M. L., Zumbrennen, K. B., Rodansky, E. S., et al. (2008). Iron-independent phosphorylation of iron regulatory protein 2 regulates ferritin during the cell cycle. *J Biol Chem*, *283*(35), 23589-23598.
- Wang, J., Chen, G., Muckenthaler, M., et al. (2004). Iron-mediated degradation of IRP2, an unexpected pathway involving a 2-oxoglutarate-dependent oxygenase activity. *Mol Cell Biol*, *24*(3), 954-965.
- Wang, J., Chen, G., & Pantopoulos, K. (2005). Nitric oxide inhibits the degradation of IRP2. *Mol Cell Biol*, *25*(4), 1347-1353.
- Wang, J., & Pantopoulos, K. (2011). Regulation of cellular iron metabolism. *Biochem J*, *434*(3), 365-381.
- Wetli, H. A., Buckett, P. D., & Wessling-Resnick, M. (2006). Small-molecule screening identifies the selanazol drug ebselen as a potent inhibitor of DMT1-mediated iron uptake. *Chem Biol*, *13*(9), 965-972.
- Wingert, R. A., Galloway, J. L., Barut, B., et al. (2005). Deficiency of glutaredoxin 5 reveals Fe-S clusters are required for vertebrate haem synthesis. *Nature*, *436*(7053), 1035-1039.
- Wu, K. J., Polack, A., & Dalla-Favera, R. (1999). Coordinated regulation of iron-controlling genes, H-ferritin and IRP2, by c-MYC. *Science*, *283*(5402), 676-679.
- Zhang, D. L., Hughes, R. M., Ollivierre-Wilson, H., et al. (2009). A ferroportin transcript that lacks an iron-responsive element enables duodenal and erythroid precursor cells to evade translational repression. *Cell Metab*, *9*(5), 461-473.
- Zimmer, M., Ebert, B. L., Neil, C., et al. (2008). Small-molecule inhibitors of HIF-2 α translation link its 5'UTR iron-responsive element to oxygen sensing. *Mol Cell*, *32*(6), 838-848.



Iron Metabolism

Edited by Dr. Sarika Arora

ISBN 978-953-51-0605-0

Hard cover, 186 pages

Publisher InTech

Published online 29, June, 2012

Published in print edition June, 2012

Iron has various functions in the body, including the metabolism of oxygen in a variety of biochemical processes. Iron, as either heme or in its "nonheme" form, plays an important role in key reactions of DNA synthesis and energy production. However, low solubility of iron in body fluids and the ability to form toxic hydroxyl radicals in presence of oxygen make iron uptake, use and storage a serious challenge. The discovery of new metal transporters, receptors and peptides and as well as the discovery of new cross-interactions between known proteins are now leading to a breakthrough in the understanding of systemic iron metabolism. The objective of this book is to review and summarize recent developments in our understanding of iron transport and storage in living systems.

How to reference

In order to correctly reference this scholarly work, feel free to copy and paste the following:

Ricky S. Joshi, Erica Moran and Mayka Sanchez (2012). Cellular Iron Metabolism – The IRP/IRE Regulatory Network, Iron Metabolism, Dr. Sarika Arora (Ed.), ISBN: 978-953-51-0605-0, InTech, Available from: <http://www.intechopen.com/books/iron-metabolism/cellular-iron-metabolism-the-irp-ire-regulatory-network>

INTECH
open science | open minds

InTech Europe

University Campus STeP Ri
Slavka Krautzeka 83/A
51000 Rijeka, Croatia
Phone: +385 (51) 770 447
Fax: +385 (51) 686 166
www.intechopen.com

InTech China

Unit 405, Office Block, Hotel Equatorial Shanghai
No.65, Yan An Road (West), Shanghai, 200040, China
中国上海市延安西路65号上海国际贵都大饭店办公楼405单元
Phone: +86-21-62489820
Fax: +86-21-62489821

© 2012 The Author(s). Licensee IntechOpen. This is an open access article distributed under the terms of the [Creative Commons Attribution 3.0 License](#), which permits unrestricted use, distribution, and reproduction in any medium, provided the original work is properly cited.

IntechOpen

IntechOpen