

We are IntechOpen, the world's leading publisher of Open Access books Built by scientists, for scientists

4,800

Open access books available

122,000

International authors and editors

135M

Downloads

Our authors are among the

154

Countries delivered to

TOP 1%

most cited scientists

12.2%

Contributors from top 500 universities



WEB OF SCIENCE™

Selection of our books indexed in the Book Citation Index
in Web of Science™ Core Collection (BKCI)

Interested in publishing with us?
Contact book.department@intechopen.com

Numbers displayed above are based on latest data collected.

For more information visit www.intechopen.com



Robotic Catheter Operating Systems for Endovascular Neurosurgery

Shuxiang Guo, Jian Guo, Nan Xiao and Takashi Tamiya
*Kagawa University
Japan*

1. Introduction

With the quickening pace of modern life, the brain diseases of people are increasing, such as cerebral aneurysm and infarction and so on. The traditional surgery spends patients a lot of operation time and has long recovery time, the burden on patients is heavy. Intracavity intervention is expected to become increasingly popular in the medical practice, both for diagnosis and for surgery. A lot of diagnosis and medical surgery with an endoscope or a catheter are performed for minimally invasive surgery recently. There are a lot of advantages as earliness etc. However, it requires a lot of skills for the operation so that this may do the operation in the inside of the body that cannot be watched directly.

Such surgery presents many challenges:

1. Doctors must be very well trained and possess the skills and experience to insert catheters. Intravascular neurosurgery is much more difficult than traditional surgery and there are few skilled doctors who can perform this type of operation. To keep pace with the growing number of patients, a mechanism is required to allow the training of sufficient numbers of doctors.
2. During the operation, doctors check the position of the catheter tip using the X-ray camera. Although they wear protective suits, it is very difficult to shield the doctor's hands and face from the effects of the X-ray radiation, which may result in radiation-related illness after long periods of exposure. The skilled surgeons operate the catheter using their hands directly, the conceptional scheme is shown in Fig.1.
3. In intravascular neurosurgery, catheters are inserted into the patient's blood vessels, which in the brain are very sensitive. When operating in this area, extreme care is required to avoid damaging the fragile vessels. An experienced neurosurgeon can achieve an accuracy of about 2 mm. However, as the contact force between the blood vessel and the catheter cannot be judged accurately by the doctor, so how to measure the contact force and feedback to the surgeon become significant.
4. Sometimes doctors cannot be physically present to operate on patients. Therefore, Internet-based master-slave systems are required for such cases so that the operation can be proceeded.

According to the above background, we developed two kinds of novel robotic catheter operating systems with danger avoiding method respectively, using the developed danger

avoiding method it can not only help surgeons to know the situation inside blood vessel, but also can support surgeon to improve safety of operating process during intravascular neurosurgery. They can also provide the force feedback to the surgeon. We did experiment "In Vitro" to prove the feasibility of the developed first robotic catheter system, and we did evaluation for the second developed robotic catheter system.

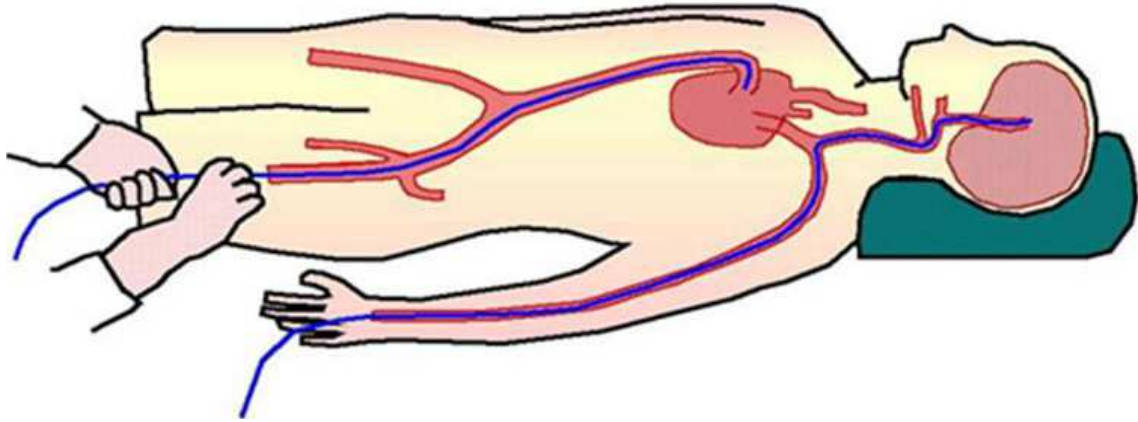

Fig. 1. Operating catheter with surgeon's hand

2. Relative products and researches on robotic catheter systems

In the past, there were a lot of researches and products on robotic catheter system. One of the more popular products is ANGIO Mentor endovascular surgical training simulator [OKB Medical], which is shown in Fig.2, it is a virtual reality (VR) simulator system, which can be used to train unskilled surgeon to do the operation of intravascular neurosurgery. However, it lacks of force feedback to the surgeons.



Fig. 2. ANGIO Mentor endovascular surgical training simulator

Another popular product is the Sensei robotic catheter system offered by Hansen Medical [Hansen Medical], which is shown in Fig.3, it can provide more precise manipulation with less radiation exposure to the doctor, however, force detection at the distal tip is very hard.



Fig. 3. Sensei robotic catheter system

Active catheter systems with SMA and ICPF as actuators were developed [S.Guo1996], new catheter driving method using linear stepping mechanism for intravascular neurosurgery has been developed [F.Arai2002], remote catheter navigation systems have been reported by [G. Srimathveeravalli2010], [Yogesh Thakur2009], [T.Goto2009], [E. Marcelli2008], and so on. Furthermore, the master-slave catheter systems were also developed [Y.Fu2011]. Although these products and catheter system have been developed, most concern is still the safety of the system. Force information of the catheter during the operation is very important to insure the safety of the surgery. A potential problem with a remote catheter control system is the lack of mechanical feedback. However, detection of the force on catheters is very hard to solve in these systems. In order to solve the problems, in this paper we proposed two kinds of novel robotic catheter systems with force feedback and monitoring image. They can provide the force feedback to the surgeon in real time.

3. Design of intelligent force sensors system

During the operation of intravascular neurosurgery, it is significant to obtain the contact force information between catheter and blood vessel [Christopher R. Wagner2002]. How to get it? And how to transmit it to the surgeon? In order to detect the contact force information between catheter and blood vessel, we developed an intelligent force sensors system for robotic catheter systems. By using the developed force sensors system, we can obtain the contact force information and feedback it to the surgeon. If there are no force sensors on the catheter, it is easy to damage the blood vessel during operating, because the blood vessel is fragile. The Fig.4 shows the comparison of safety between without force sensors on catheter and with force sensors on catheter.

3.1 Development of micro force sensors

The state-of-the-art in force and tactile sensing for minimally invasive surgery (MIS) has been reported [P. Puangmali2008], it presents the significance of the tactile sensor in MIS. Some tactile force sensors have been reported for the application of intravascular

neurosurgery [R. Sedaghati2005], [K. Takashima2005, 2007], a micro force sensor on the catheter tip has been used in previous studies [Jan Peirs2004], and so on. However, these could only detect the contact force between the catheter head and the blood vessels, the frictional force and contact force between the side of catheter and blood vessel wall were not been paid attention. In order to solve above existed problems, in this paper, novel micro tactile force sensors were developed to measure the frictional force and contact force between blood vessel and the side of the catheter. The prototype of the developed tactile force sensors are shown in Fig.5, which are made of pressure sensitive rubber, their sizes are $4.0 \times 4.0 \times 0.5$ mm and are fixed on the side wall of catheter by a linking shape.

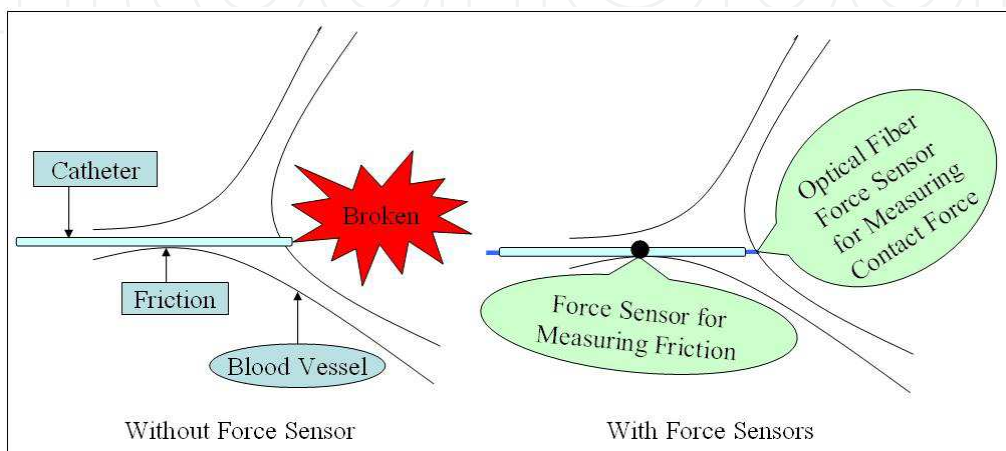

Fig. 4. Comparison of safety between two situations (Without force sensors and with force sensors)

A micro optical force sensor was used to measure front end force of the catheter, meanwhile, the optical fibre force sensor was served as guide wire to lead the catheter for inserting and rotating. The FOP-M optical fibre force sensor of FISO Technologies Inc. was used this time in our research.

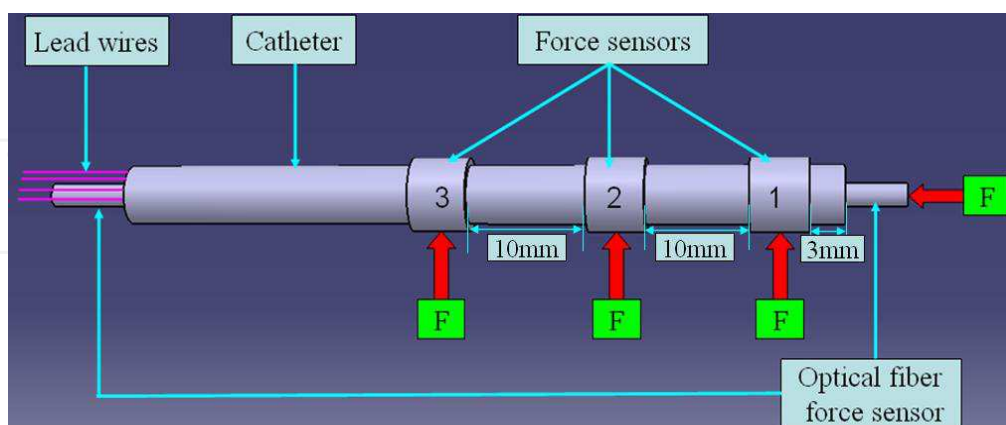

Fig. 5. Prototype of developed force sensors system

3.2 Calibration for the developed tactile force sensors

The calibration of the developed tactile force sensors was done, the calibration system is shown in Fig. 6, which consists of an electronic balance, a serial electric circuit, an

oscilloscope, a power supply and a force load, we adjust the force load to different scale, the electronic balance will become different value, the tactile force sensor is loaded different value with force load, the tactile sensor output is different, the calibration results are shown in Fig.7, they indicated the relationship between load force and sensor output, based on the calibration results, we can obtain the concrete force output information of tactile sensors during the operation.

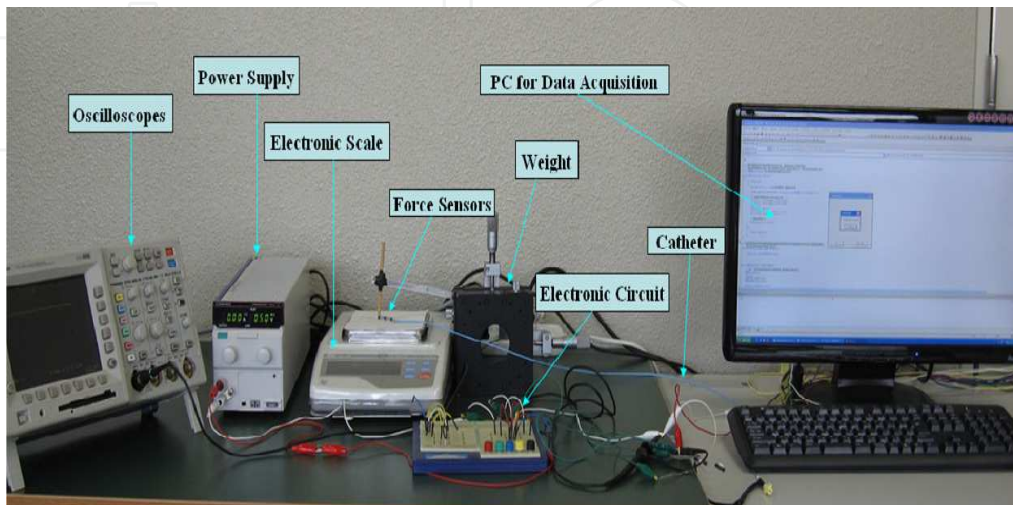

Fig. 6. Calibration system for the developed force sensors

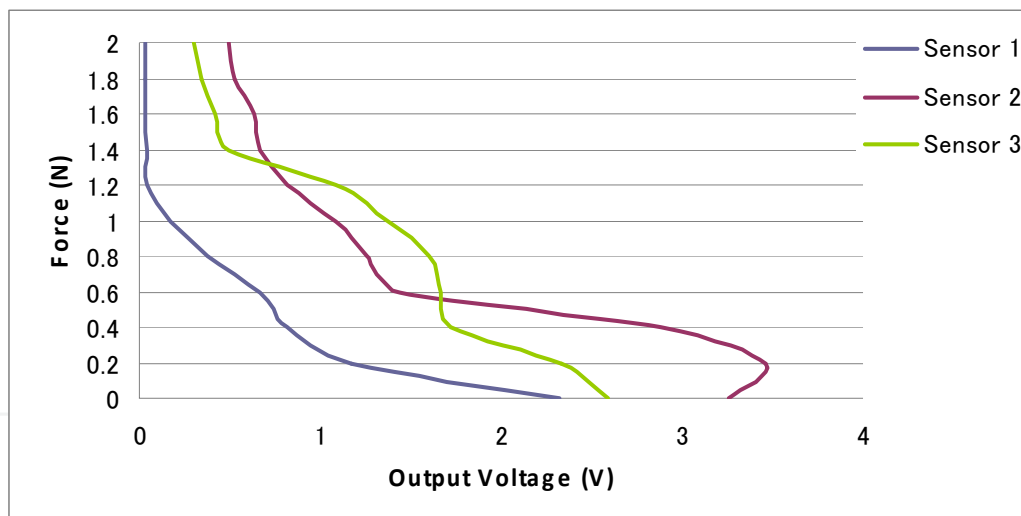

Fig. 7. Calibration results for the developed force sensors

3.3 Curve fitting equation for the calibration results

Based on the calibration results, we establish an equation between sensor outputs and load force using Matlab curve fitting tool, it is shown in equation (1), and we can also obtain the coefficient of equation for sensor1, sensor2 and sensor3, it is shown in table 1. Matlab curve fitting results for tactile force sensors are shown in Fig.8.

According to this equation, we can get the detail force output value of developed tactile force sensors if the tactile force sensors touch the blood vessel wall. Through the concrete

force output value, surgeon can monitor the situation which catheter contact with the blood vessel sidewall.

$$f = c_{i3}v^3 + c_{i2}v^2 + c_{i1}v + c_{i0} \quad (i = 1, 2, 3) \quad (1)$$

Coefficient	Sensor 1	Sensor 2	Sensor 3
Ci3	-0.4762	-0.1874	-0.03155
Ci2	2.075	1.368	0.2049
Ci1	-2.97	-3.406	-1.15
Cio	1.668	3.25	2.145

Table 1. Coefficient of proposed cubic equation

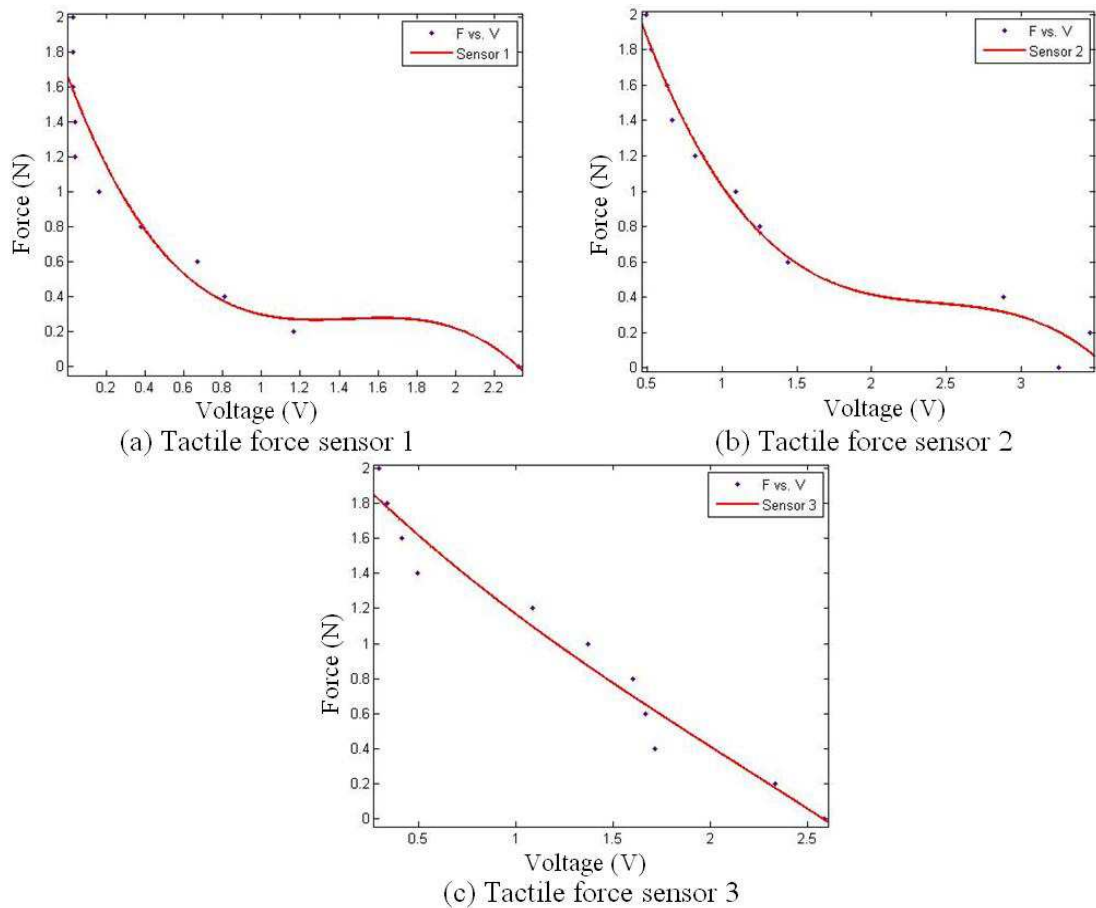

Fig. 8. Matlab curve fitting results for tactile force sensors

3.4 Force monitoring system

A force display method for a catheter operating system has been developed [J.Guo et al 2010], this method distinguished the force from developed force sensors to three ranges, safe range, danger warning range and dangerous range, however, this force display method did not show the detail force information at any moment, so surgeons could not know the concrete force information at any time, therefore, we improved the force information

monitoring method so that surgeon can know the detail information at any moment during the operation, Fig.9 shows the force information monitoring system on the master side.

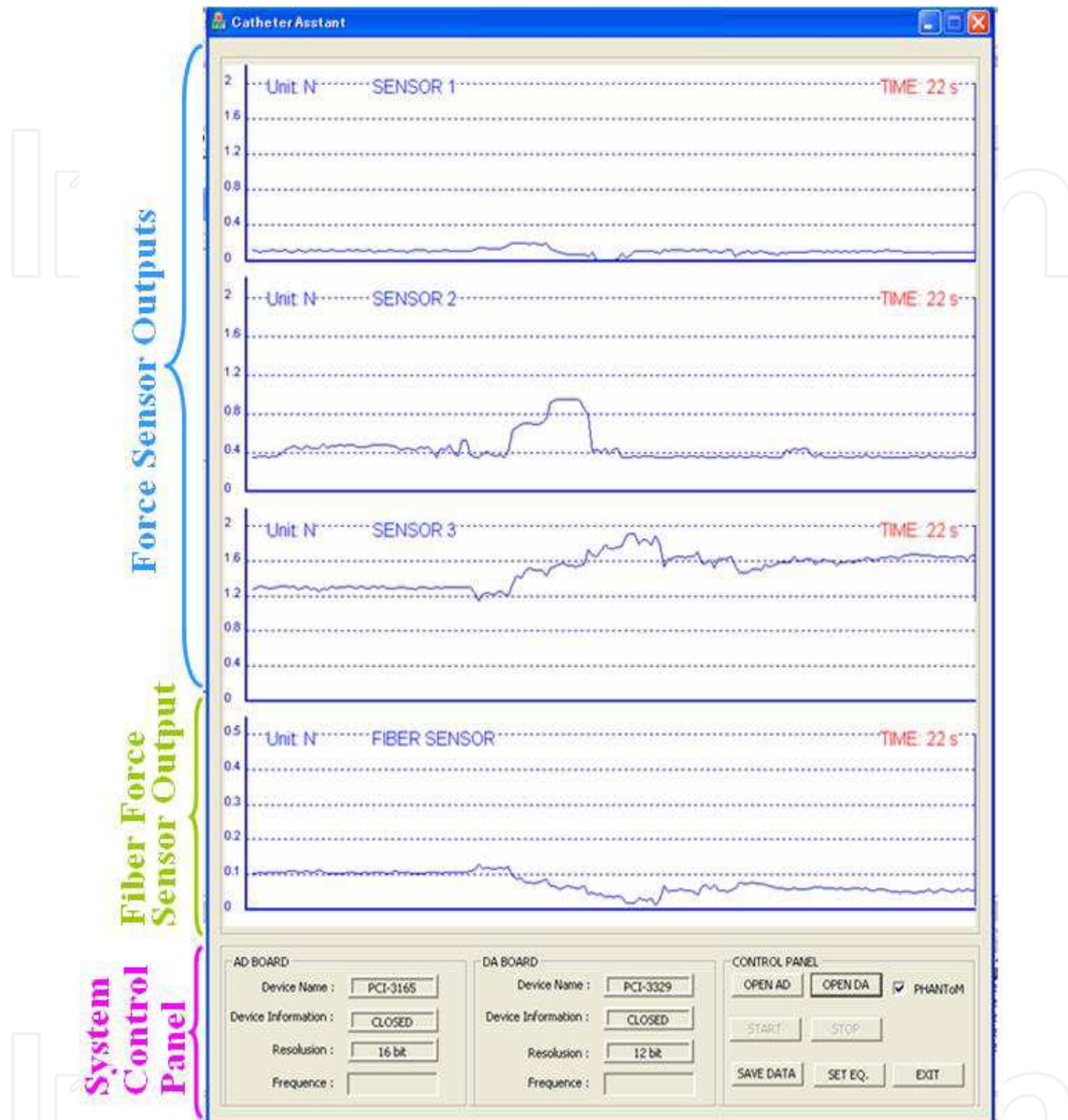

Fig. 9. Force information monitoring system

The novel force information monitoring method consists of two parts, sensor outputs part and system control panel part, which can monitor the changed force that catheter contact with blood vessel wall real time during the operation, in the sensor outputs part, it is divided four areas, three developed tactile force sensor outputs display areas and an optical fibre force sensor output display area. We can control the master-slave system in the system control panel part. Three tactile force sensors were used to measure the side force of catheter, and an optical force sensor was used to detect the front end force of catheter, if the force sensors touch the blood vessel, the output of force sensors will be shown in the force monitoring system real time, at the same time, the force feedback signals will be sent to the Phantom Omni, further more, The situation of operation can be monitored using web

camera. In the master side, surgeons can not only monitor the force variation real time, but also they can feel the force feedback through Phantom Omni, when the contacted force is exceeded safe value, the Phantom Omni will be locked, so the developed system can automatically avoid the danger, and it can help surgeon improve the safety effectively during the operation.

4. Robotic catheter operating systems

Our research group developed two kinds of robot-assisted catheter system in the past, one kind is with haptic device called Phantom Omni as master manipulator, the other kind is with the master manipulator which can imitate surgeon's operating skill to insert and rotate catheter, we will introduce them as follows:

4.1 The first developed robotic catheter operating system

The first developed robotic catheter operating system is shown in Fig.10, at master side, the surgeon sees the monitoring image and operates the Phantom Omni, at the same time, the controlling instructions were transmitted to the slave side, after receiving the controlling instructions from master side, the slave manipulator drives the catheter to insert and rotate. Bu using the web camera to monitor the situation of operation, and by using force sensors to measure the contact force between catheter and blood vessel, the monitoring image and feedback force were transmitted to the surgeon in real time, based on the feedback force and monitoring image, the surgeon decides whether to insert the catheter or not. The flow chart of control signals is shown in Fig.11.

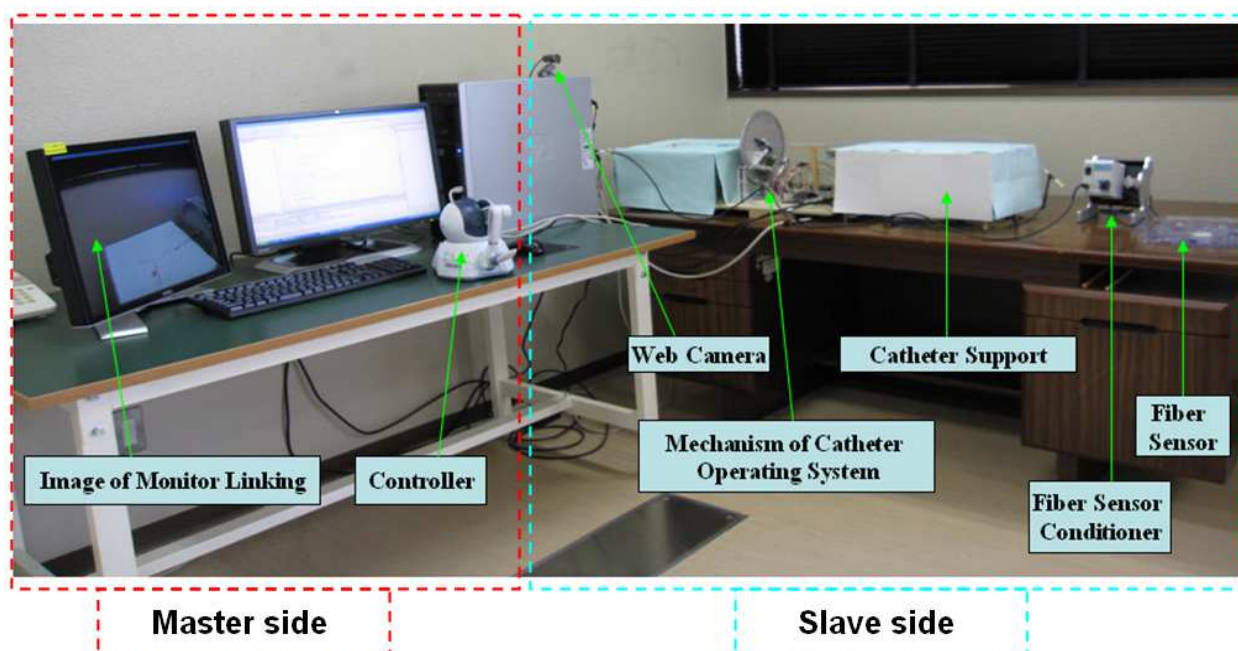

Fig. 10. The first developed master-slave robotic catheter system

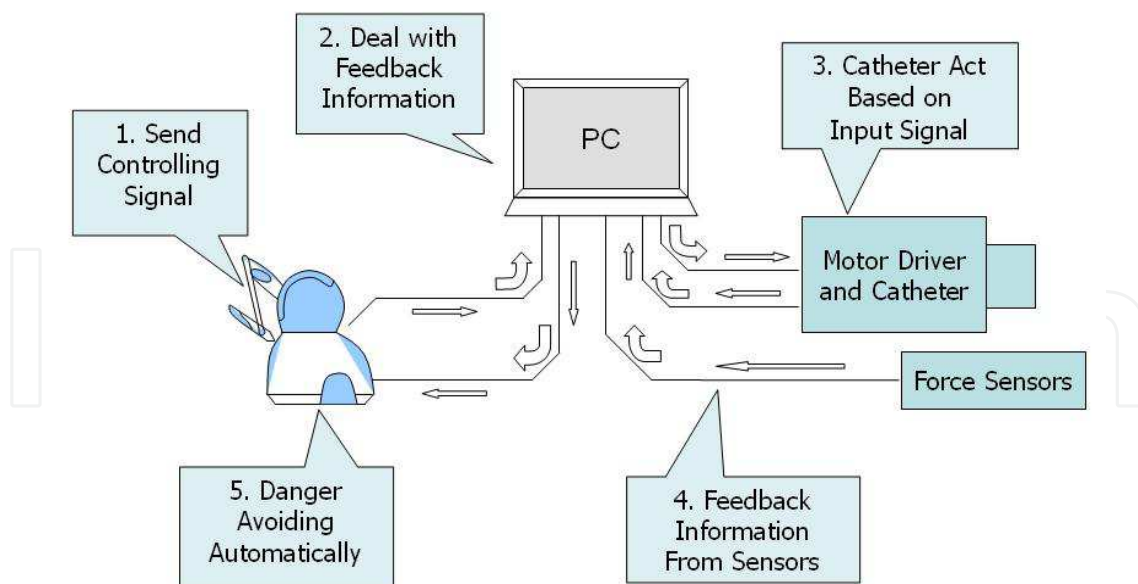

Fig. 11. Flow chart of control signals for first kind of catheter system

4.1.1 Master manipulator

The master manipulator is shown in Fig.12, called Phantom Omni, it is a haptic device, in this research, it was used to control the action of catheter, including inserting motion and rotating motion, we also use it to realize force feedback to avoid danger during operation of intravascular neurosurgery, when the force sensors contacted with blood vessel, the force feedback will be transmitted to the surgeon’s hand in real time, if the contact forces exceeded warning force value, the Phantom Omni will be locked, so the developed catheter operating system can avoid the danger automatically, and it can help surgeon improve the safety effectively during the operation.



Fig. 12. Coordinate system of Phantom Omni

In order to realize the force feedback using Phantom Omni, the mechanical model of Phantom Omni was established, it is as follows:

The Phantom Omni output force \vec{F} is:

$$\vec{F} = xi + yj + zk \tag{2}$$

Z direction is the inserting direction.

X direction is the rotating direction.

$$x \cdot z \equiv 0 \quad (3)$$

f_1, f_2, f_3 is the forces that were measured by the developed force sensors.

f_4 is the force that was measured by the optical fibre force sensor.

When catheter is inserted, the Phantom Omni output force is as follows:

$$\begin{aligned} \vec{F} &= 0 \cdot i + 0 \cdot j + A_i k \\ A_i &= \begin{cases} 0 & (f_4 < C_0) \\ k \cdot f_4 & (f_4 > C_0) \end{cases} \quad (k < 0) \end{aligned} \quad (4)$$

When catheter is rotated, the Phantom Omni output force is as follows:

$$\begin{aligned} \vec{F} &= A_r \cdot i + 0 \cdot j + 0 \cdot k \\ f_{\max} &= \max(f_1, f_2, f_3) \\ A_r &= \begin{cases} 0 & (f_{\max} < C_1) \\ k \cdot f_{\max} & (f_{\max} > C_1) \end{cases} \quad (k < 0) \end{aligned} \quad (5)$$

Based on the mechanical model of Phantom Omni, the force feedback output from Phantom Omni can be obtained, the value of the Phantom Omni force feedback is the force that surgeon feels. So the haptic force feedback can be realized by Phantom Omni and force sensors.

4.1.2 Slave manipulator

The conception of slave manipulator is shown in Fig.13, it can realize two motions for catheter, one is axial motion (moving forward and back-ward), and the other is radial motion (rotation). The catheter mostly moves forward and backward. When meeting the branch of blood vessel or moving difficulty, the catheter must rotate in order to enter the branch of blood vessel or get across block.

The mechanism of slave manipulator is shown in Fig.14, we make use of stepping motors as the actuators for driving the catheter. They can control the catheter moving to different directions. Considering the weight of mechanism, the whole mechanism is made of aluminium. The base of mechanism is made of stainless steel in order to increase the stabilization.

4.1.3 Experimental set up

We carried out the remote operating simulation experiment "in Vitro" using developed master-slave system in the simulator of blood vessel with an aneurysm, the simulator of blood vessel is made by silicon glass tube, which is shown in Fig.15. It is considered whose conditions are similar to those of a blood vessel of human brain.

Through the remote operating simulation experiment, we can measure the contact force between blood vessel wall and the catheter by developed micro tactile force sensors and optical fibre force sensor. Using the developed force monitoring system, we can obtain the outputs from micro tactile force sensors and optical fibre force sensor.

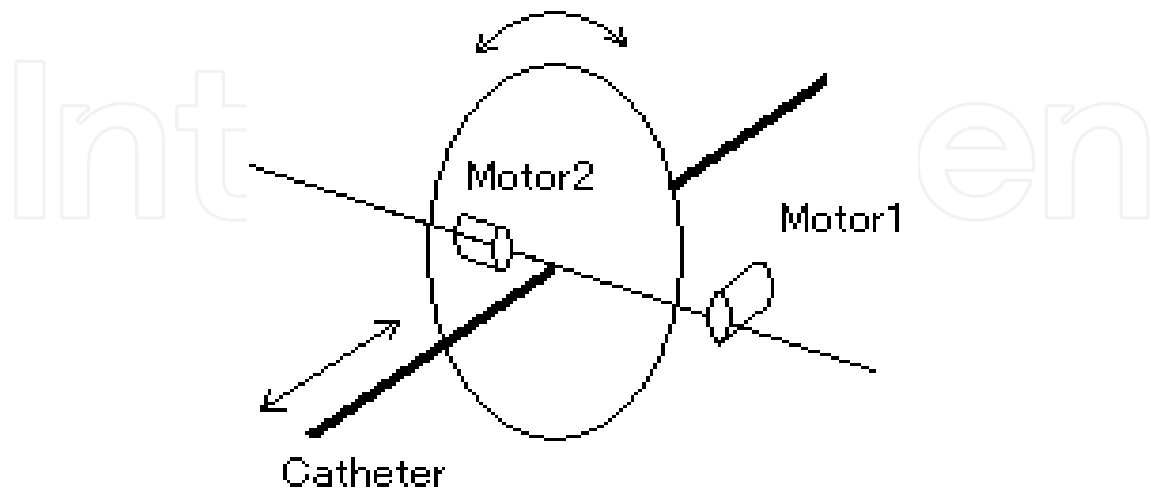

Fig. 13. Conception of slave manipulator

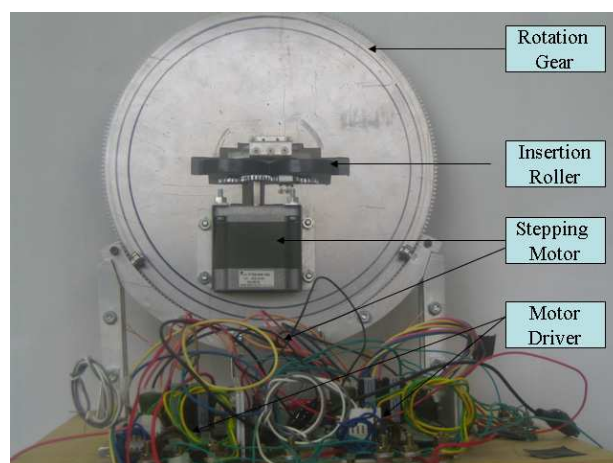

Fig. 14. Mechanism of slave manipulator

The experimental results are shown in Fig.16, Fig.17 and Fig.18. The output of developed tactile sensors are shown in Fig.16, the output of optical fibre force sensor is shown in Fig.17, making use of the mechanical model of Phantom omni, we can get the force feedback output of Phantom Omni, which is shown in Fig.18. From the graph we can know the relationship between operating time and force feedback from force sensors, and also we can know the force value when force sensors contact the simulator of blood vessel. It can also prove that the Phantom Omni is sensitive, and also it can avoid the danger automatically. The experimental results indicated that the developed novel type catheter operating system with force information monitoring method works properly, it can measure the contact force between catheter and blood vessel, also we can monitor the situation of simulation experiment using web camera, this catheter operating system can be controlled by teleoperation, and it can effectively improve the operability of aneurysm with force feedback for intravascular neurosurgery.

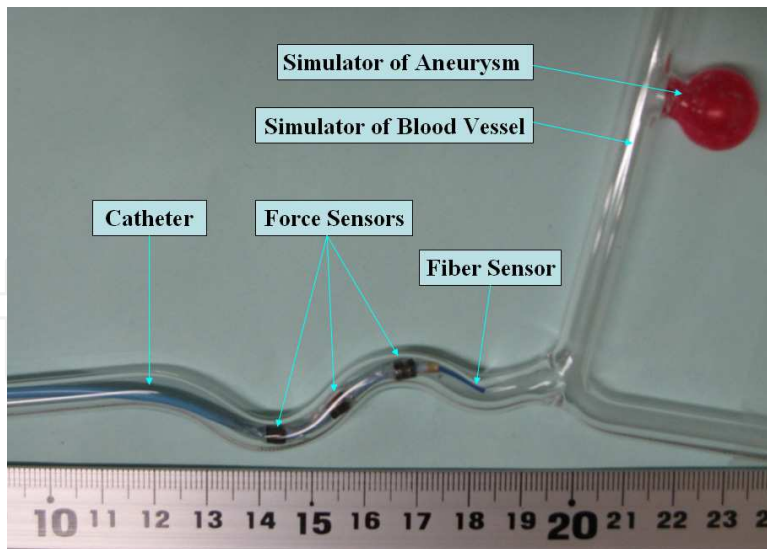

Fig. 15. Experimental set up

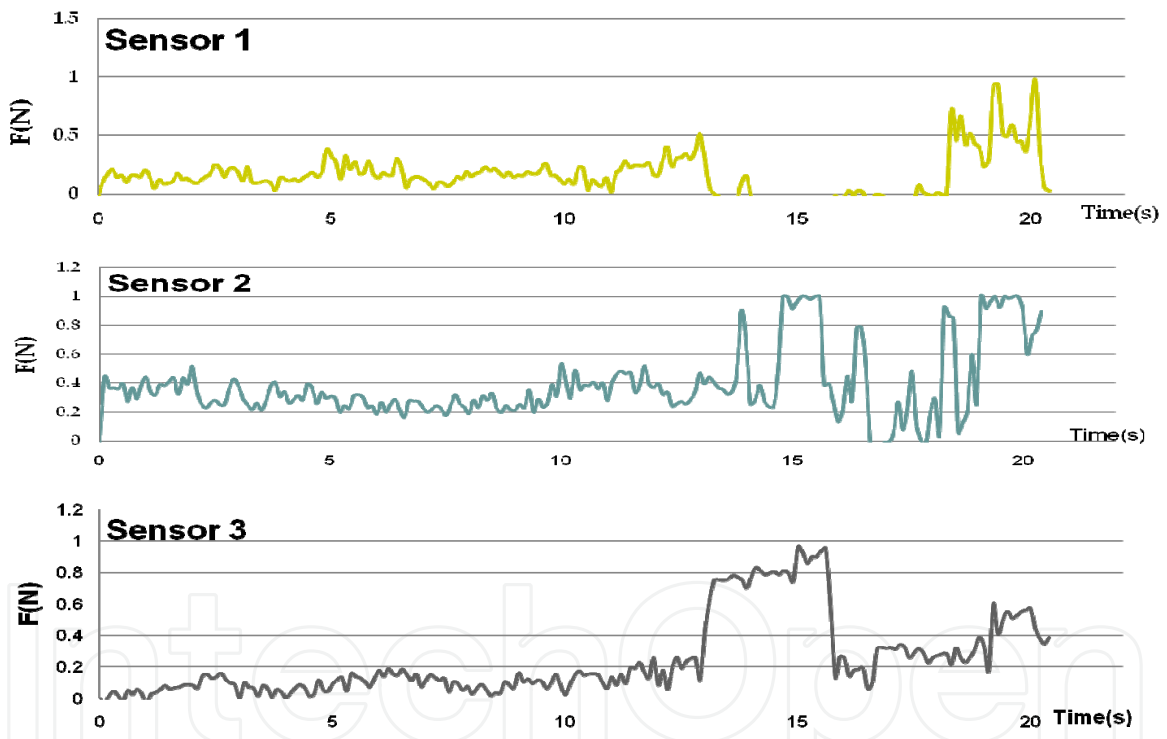

Fig. 16. Force outputs of developed tactile force sensors

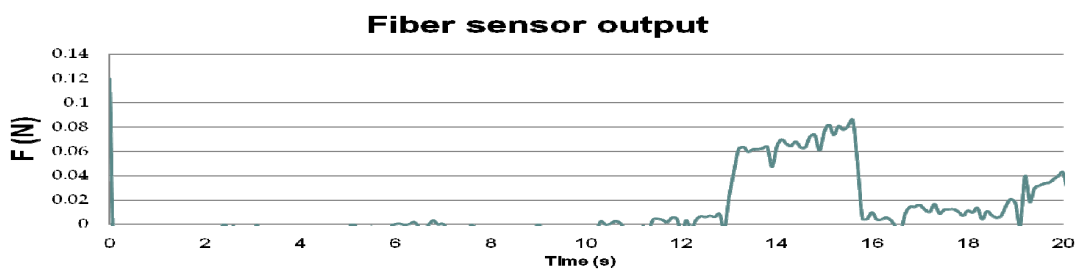

Fig. 17. Force output of optical fibre force sensor

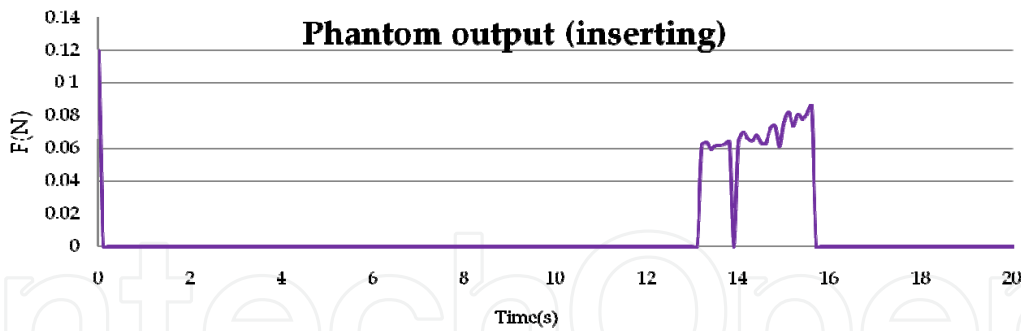

Fig. 18. Force feedback output of Phantom Omni

4.2 The second developed robotic catheter operating system

Because the Phantom manipulator can not imitate the operating skill of surgeon, we developed the other kind of robotic catheter system to simulate surgeon’s operating skill for doing the operation of intravascular neurosurgery. Conceptual scheme of the second kind of robotic catheter system is shown in Fig.19. The flow chart of control signals for second kind of catheter system is shown in Fig.20.

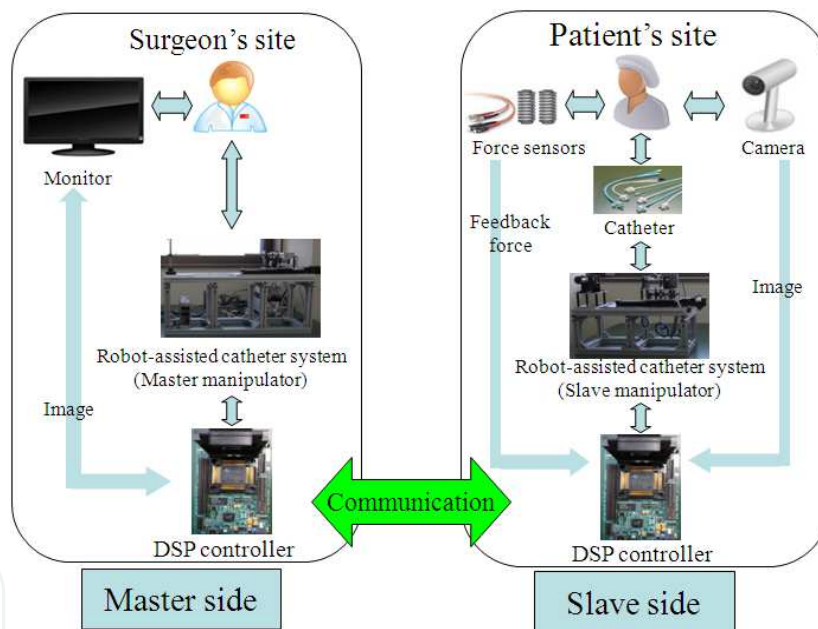

Fig. 19. Conceptual scheme of the second kind of robotic catheter system

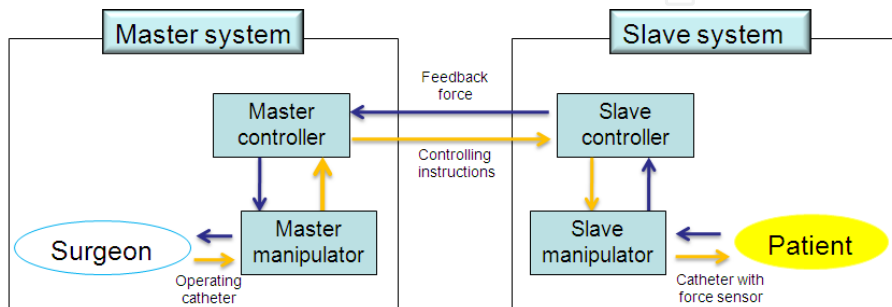

Fig. 20. Flow chart of control signals for second kind of catheter system

4.2.1 Master manipulator

On the master side, the slide platform is fixed on the supporting frame (Fig.21). The master system devices, including a left handle with one switch, a right handle, step motor, load cell, and maxon motor, are on the slide platform. The step motor is used to drive the slide platform forward and backward, the load cell is used to measure the operating force of surgeon's hand.

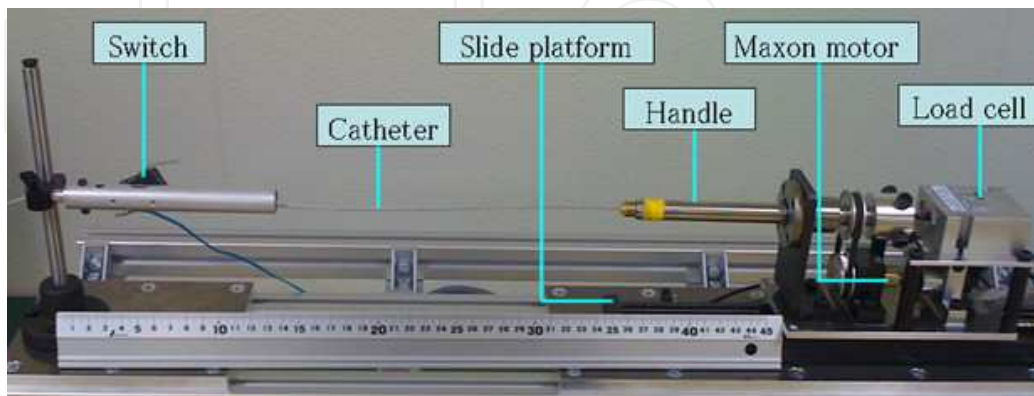

Fig. 21. Master manipulator

4.2.2 Slave manipulator

The slave side consists of a catheter clamping device, two DC motors, a slide platform, step motor, maxon motor, load cell, torque sensor, and support frame. The slave side mechanism shown in Fig.22 is similar to the master side; a slide platform is fixed on the supporting frame. The devices of the slave system are on the slide platform. The step motor is used to drive slide platform forward and backward and the maxon motor is used to rotate the catheter. The two DC motors are used to control the catheter clamp. The load cell is used to measure the force between the catheter and blood vessel wall and the torque sensor and maxon motor are used to measure the force of catheter rotation. The measured force information is transmitted to the surgeon's hand, so that the surgeon can feel the feedback information from the slave side. A switch on the left handle on the master side controls the catheter clamp. When the surgeon wants to insert or rotate the catheter, clamp 2 is raised and clamp 1 clamps the catheter. The catheter navigator moves forward with the catheter for insertion or rotation. Clamp 2 then clamps the catheter; clamp 1 is raised and the catheter navigator moves backward. Repeating these actions, the actions of the slave side follow the commands of the master side in real time. If the catheter contacts the blood vessel wall, the force information is detected and transmitted to the surgeon's hand.

4.2.3 Mechanism control

In order to ensure the consistency and stability of the robotic catheter system, for both the rotating and inserting motions, a proportional-integral-derivative (PID) control method was developed for the robotic catheter operating system. A numerical simulation indicated that the response of the system was good using the PID control method. Furthermore, we did a simulation experiment using the robotic catheter system with the PID control strategy. The experimental results show that the response and consistency were good, enabling a surgeon to perform intravascular neurosurgery.

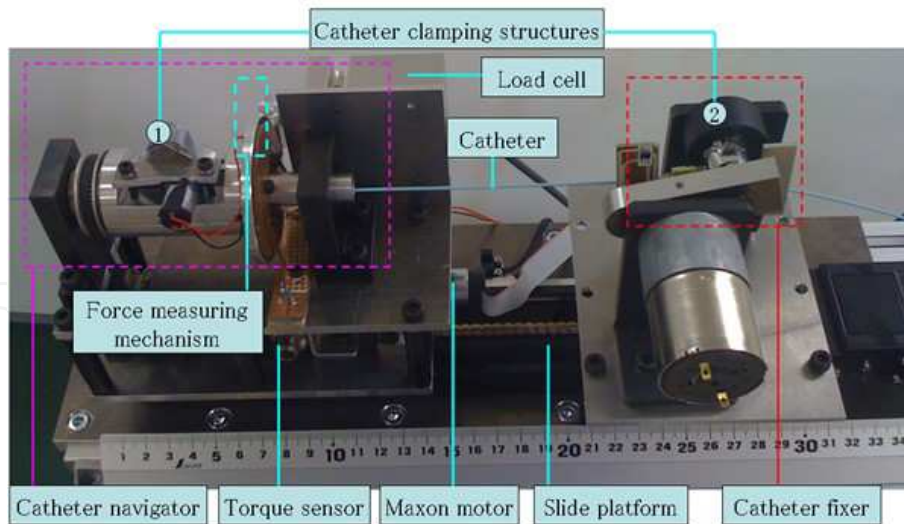

Fig. 22. Slave manipulator

4.2.3.1 Control strategy for inserting motion

We used the PID algorithm to assure accurate inserting motion, while reducing the hysteresis in real time. The following dynamic equation represents the control in the inserting direction:

$$F(t) = m\ddot{x}(t) + c\dot{x}(t) + kx(t) \quad (6)$$

Where $F(t)$ is the force applied by the operator, $x(t)$, $\dot{x}(t)$, and $\ddot{x}(t)$ are the displacement, velocity, and acceleration of the operator's hand, respectively, m is the quality of the robotic catheter operating system (on the slide platform on the master side), c is the viscous damping coefficient, and k is the stiffness.

When the operator operates the right handle on the master side, the load cell measures the force. Using a dynamic equation based on the relationship between the operating force and resistance, the PID control strategy is used to adjust the consistency of the operating force in order to avoid overshoot. Fig.23 outlines the control of the inserting motion. The parameters of the operating system are as follows:

$$m = 2kg, c = 0.02N / (m / s), k = 10N / m$$

As on the master side, based on the input and output of the step motor, we used the same PID control strategy on the slave side to control the consistency and response of the slave mechanism during insertion.

4.2.3.2 Control strategy for rotating motion

Equation (7) represents the torque balance for the rotating motion on the master side, where m is the quality of the catheter operating system (on the slide platform on the master side), c is the viscous damping coefficient, $m = 2kg, c = 0.02N / (m / s)$, θ is the angle of rotation, $u(t)$ is the variation in the torque, which is the torque of the maxon motor, $\dot{\theta}$ is the angular velocity, and $\ddot{\theta}$ is the angular acceleration. The control of rotation is shown in Fig.24.

$$m\ddot{\theta} + c\dot{\theta} = u(t) \quad (7)$$

As on the master side, based on the input and output of the maxon motor, we used the same PID control strategy on the slave side to ensure the consistency and response of the slave mechanism for rotation.

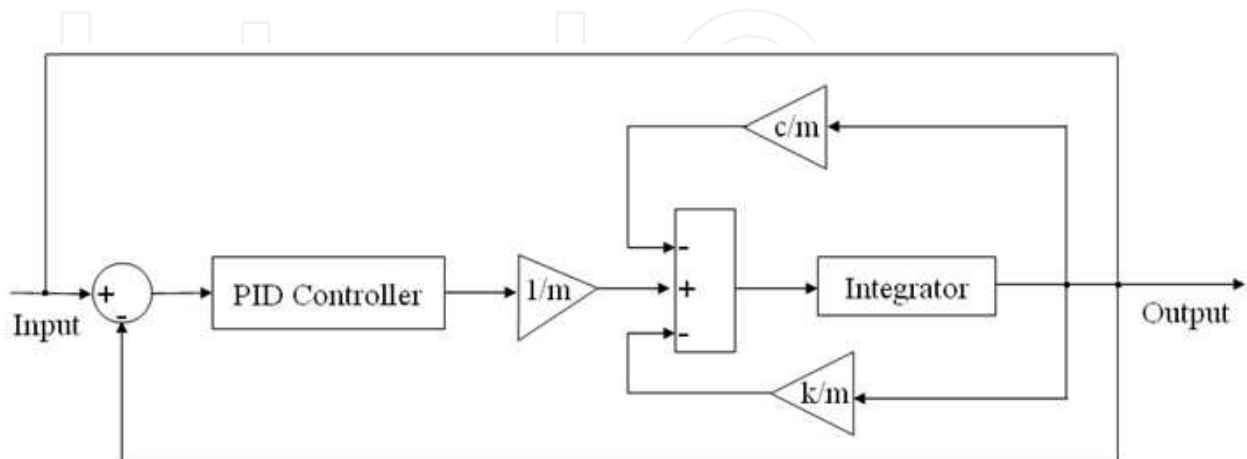

Fig. 23. The control of the insertion

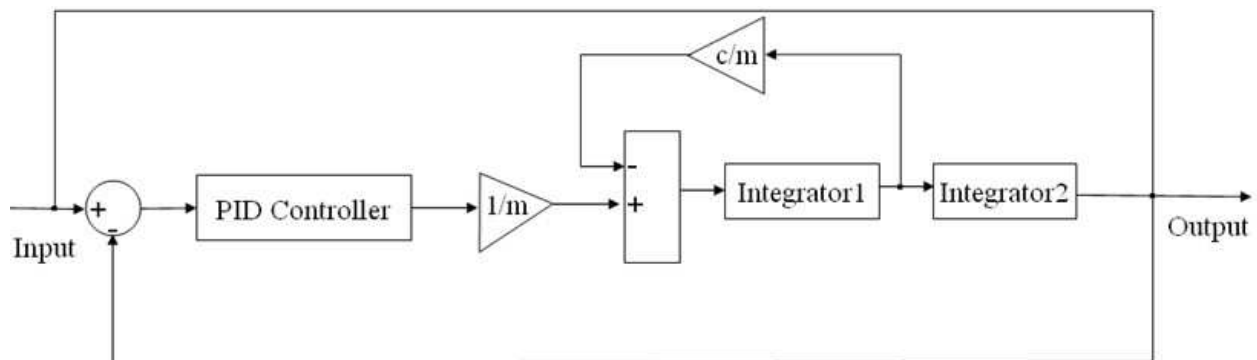

Fig. 24. The control of rotation

4.3 Catheter inserting experiment in vitro

In order to validate the robotic catheter operating system, we performed a simulation experiment to evaluate the characteristics of the master-slave robotic catheter operating system using an endovascular evaluator (EVE) (Fig. 25), which consisted of a fluid control unit and blood pressure monitoring instrument. The bending angles and radii of the tubes in the EVE are close to those of human arteries. The tubes were made of silicon rubber. The elasticity of the tubes was similar to that of a blood vessel wall. In order to keep the blood pressure of the EVE close to the blood pressure of a human, the fluid control unit was used to adjust the blood pressure, which was monitored with the blood pressure monitoring instrument. The operator operates the right handle on the master side to insert and rotate the catheter, which is inserted into the EVE from the femoral artery, controlling the speed and position of the catheter. The simulation experiment is shown in Fig. 26.

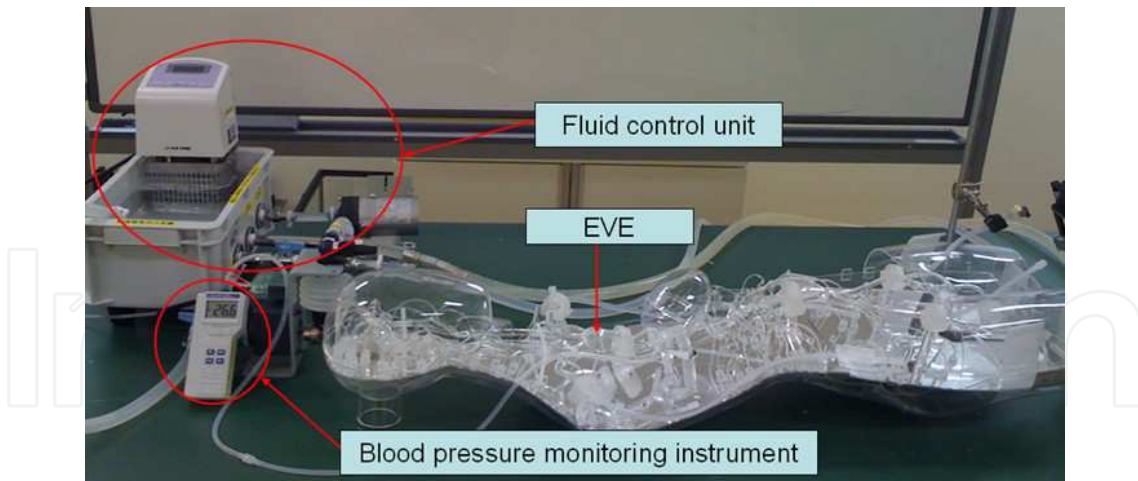

Fig. 25. The fluid control unit and blood pressure monitoring instrument of EVE

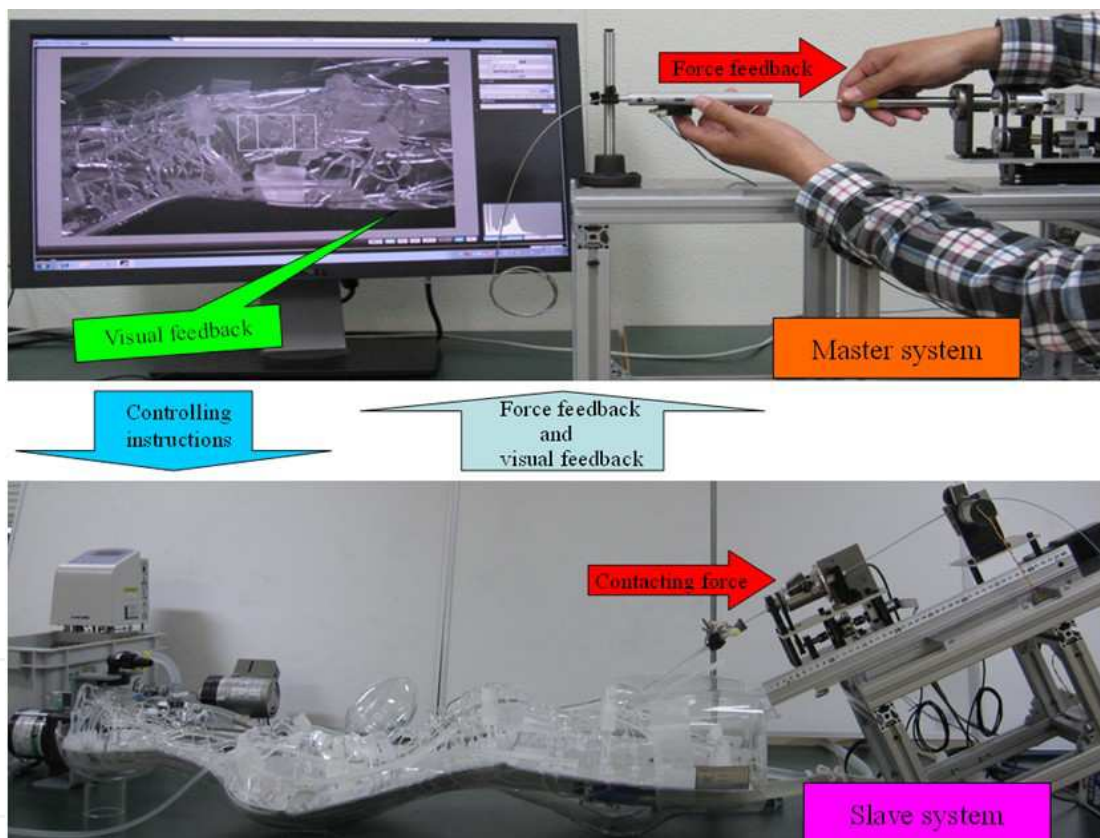

Fig. 26. Simulation experiment using EVE

4.3.1 Experimental results

We evaluated the robotic catheter system in a simulation experiment. Fig. 27 shows the results for the inserting motion, where the x-axis is the time axis and the y-axis is the displacement of the right handle on the master side (blue curve) and the catheter on the slave side (red curve). An upward slope is forward movement and a downward slope is backward movement. Fig. 28 shows the evaluation of rotation, where the x-axis is the time axis and the y-axis is the rotation of the right handle on the master side (blue curve) and the

catheter on the slave side (red curve). From Figs. 27 and 28, the motions of the slave side follow the operating motions of the master side coincide very well in real time.

The measured insertion force is shown in Fig. 29, and this is also the feedback force transmitted to the operator's hand. The force sensors measure the contact force between the catheter and blood vessel wall. The fibre force sensor measures the force between the tip of the catheter and the blood vessel wall, the output of the fibre force sensor is shown in Fig. 30.

The experimental results indicate that our robotic catheter system can be used to perform VIS, without risk. The insertion force of the catheter is measured and fed back to the operator's hand, as is the contact force measured by the force sensors.

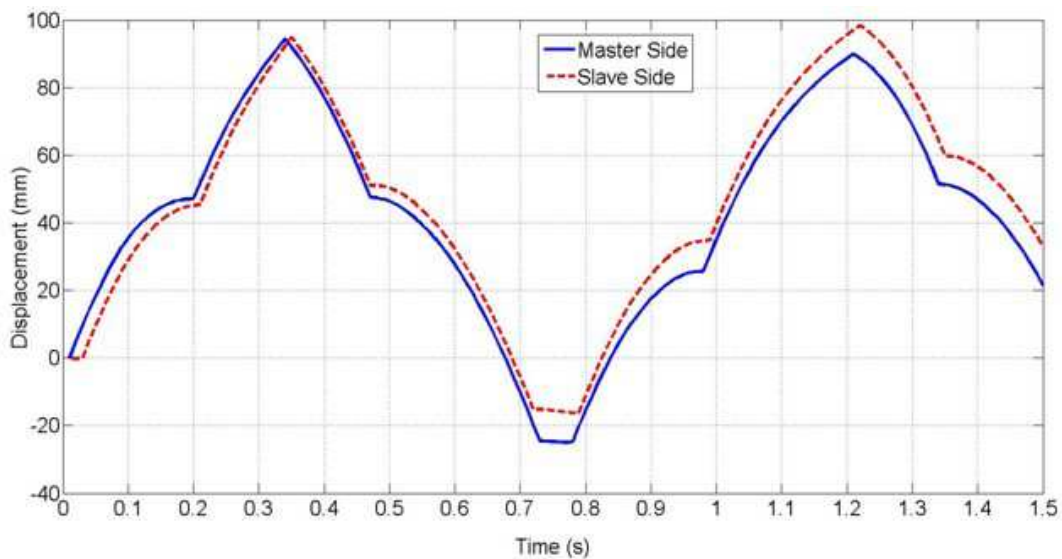

Fig. 27. Evaluated results for catheter insertion

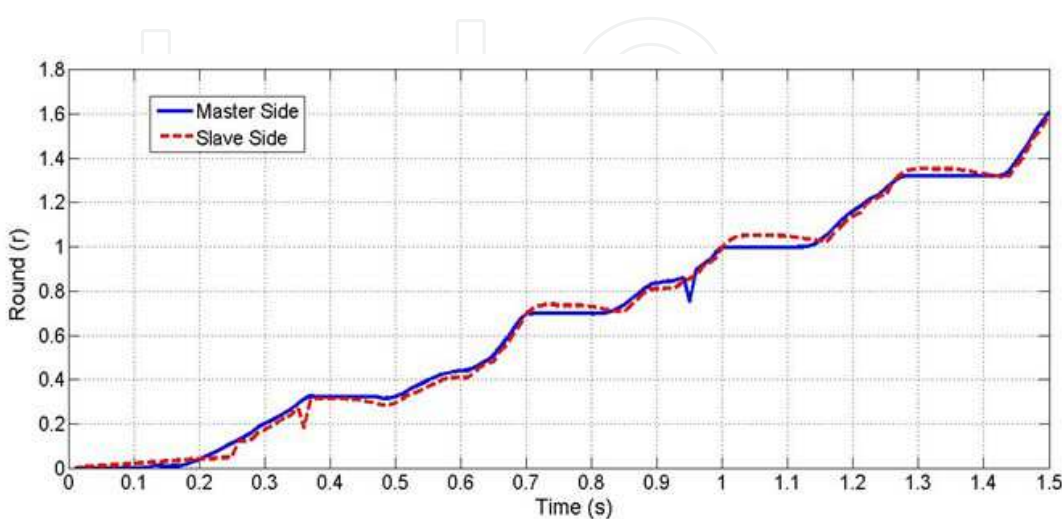

Fig. 28. Evaluated results for catheter rotation

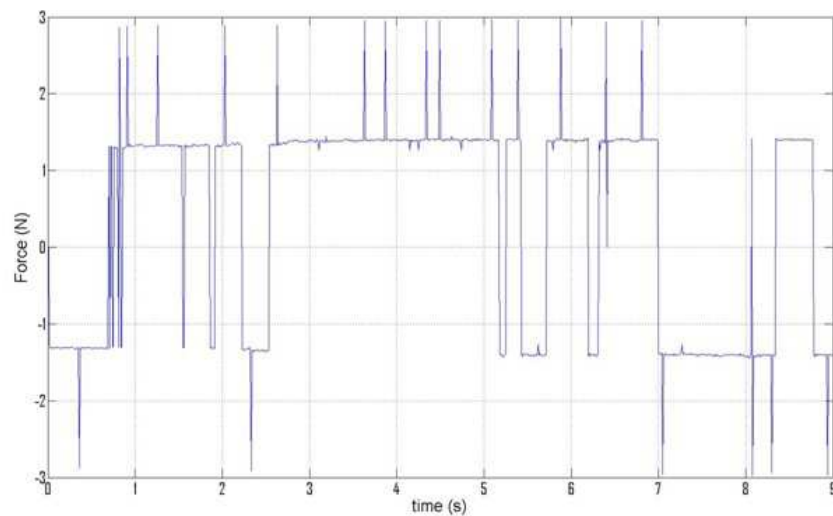

Fig. 29. The feedback force from the slave side

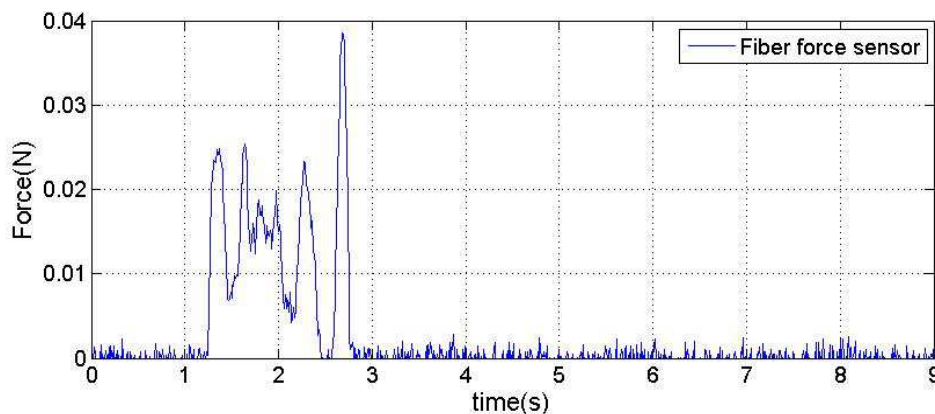

Fig. 30. The output of the fibre force sensor

4.3.2 Discussion

A simulation experiment was performed to validate our robotic catheter system. In order to enhance the stability and consistency of the robotic catheter system, we used a PID control strategy. The experimental results indicate that the response and consistency of the system were good, enabling a surgeon to perform VIS. It can also be used to train surgeons to insert and rotate a catheter for VIS smoothly. Nevertheless, due to the accuracy of the measuring device, the robotic catheter system is not ideal. In the future, we will improve the system. In addition, in the simulation experiment we used distilled water with a lubricant to simulate blood. Since the viscosity of distilled water differs from that of blood, the experimental results will differ slightly from an actual operation. We plan to improve the system by conducting animal experiments.

5. Conclusions

This paper presents two kinds of robotic catheter operating systems, they can assist surgeons to do the operation of intravascular neurosurgery, in addition, we designed a intelligent force sensors system to detect the contact force information between catheter and

blood vessel, and also, we have done the simulation experiment "In Vitro" by using first developed robotic catheter system, the experimental results indicated that the first developed robotic catheter system work well, it can avoid danger automatically. We evaluated the second robotic catheter operating system via experiment in vitro by using EVE model, the evaluated results present that the second robotic catheter system can imitate the surgeon's operating skill to insert and rotate catheter, it is suitable for training unskilled surgeons to do the operation of intravascular neurosurgery. In the future, we will do some experiment in vivo by using the robotic catheter system.

6. Acknowledgment

This research is supported by Kagawa University Characteristic Prior Research fund 2011.

7. References

- C. Preusche, T. Ortmaier, G. Hirzinger.(2002), Teleoperation concepts in minimal invasive surgery. *Control Engineering Practice*, 2002; 10:1245-1250.
- C.R. Wagner, Nicholas Stylopoulos, Robert D. Howe(2002), The role of force feedback in surgery: analysis of blunt dissection, the Tenth Symposium on Haptic Interfaces for Virtual Environment and Teleoperator System, 2002.
- E. Marcelli, L. Cercenelli, G. Plicchi.(2008), A novel telerobotic system to remotely navigate standard electrophysiology catheters, *Computer in Cardiology* 2008; 35:137-140.
- F. Arai, R. Fujimura, T. Fukuda, M. Negoro.(2002), New catheter driving method using linear stepping mechanism for intravascular neurosurgery. *Proceedings of the 2002 IEEE International Conference on Robotic & Automation*, 2002; pp. 2944-2949.
- G. Srimathveeravalli, T. Kesavadas, X. Li.(2010), Design and fabrication of a robot mechanism for remote steering and positioning of interventional devices, *International Journal of Medical Robotics and Computer Assisted Surgery* 2010; 6:160-170.
- Hansen Medical, <http://www.hansenmedical.com/sensei>
- J. Wang and S. Guo, H. Kondo, J. Guo and T. Tamiya.(2008), A Novel Catheter Operating System with Force Feedback for Medical Applications, *International Journal of Information Acquisition*, Vol.5, No.1, pp.83-91, 2008.
- J. Peirs, Joeri Clijnen, Dominiek Reynaerts, Hendrik Van Brussel, Paul Herijgers, Brecht Corteville, et. al.(2004), A micro optical force sensor for force feedback during minimally invasive robotic surgery, *Sensors and Actuators*, Vol.115, No.2-3, pp.447-455, 2004.
- J. Guo, N. Xiao, S. Guo.(2010), A force display method for a novel catheter operating system, *Proceedings of the 2010 IEEE International Conference on Information and Automation*, 2010; pp. 782-786.
- J. Guo, N. Xiao, S. Guo, T. Tamiya.(2010), Development of a force information monitoring method for a novel catheter operating system, *Information: An International Interdisciplinary Journal*, 2010; 1(6):1999- 2009.

- K. Takashima, K. Yoshinaka, T. Okazaki, K. Ikeuchi.(2005), An endoscopic tactile sensor for low invasive surgery. *Sensors and Actuators A* 2005; 119:372-383.
- K. Takashima, R. Shimomura, T. Kitou, H. Terada, K. Yoshinaka, K. Ikeuchi.(2007), Contact and friction between catheter and blood vessel. *Tribology International* 2007; 40:319-328.
- OKB Medical, <http://www.okbmedical.com/angio>
- P. Puangmali, K. Althoefer, L.D. Seneviratne, D. Murphy, P. Dasgupta.(2008), State-of-the-art in force and tactile sensing for minimally invasive surgery. *IEEE Sensors Journal*, 2008; 8(4):371-381.
- P. Polygerinos, T. Schaeffter, L. Seneviratne, K. Althoefer.(2009), Measuring tip and side forces of a novel catheter prototype: a feasibility study, *Proceedings of the 2009 International Conference on Intelligent Robots and System*, 2009; pp. 966-971.
- Q. Pan, S. Guo, T. Okada.(2011), A novel hybrid wireless microrobot, *International Journal of Mechatronics and Automation*, 2011; 1(1):60-69.
- R. Sedaghati, J. Dargahi, H. Singh.(2005), Design and modeling of an endoscopic piezoelectric tactile sensor, *International Journal of Solids and Structures*, Vol.42, No.21-22, pp.5872-5886, 2005.
- S. Abdulla, P. Wen.(2011), Robust internal model control for depth of anaesthesia, *International Journal of Mechatronics and Automation*, 2011; 1(1):1-8.
- S. Guo, Hidekazu Kondo, Jian Wang, Jian Guo, Takashi Tamiya.(2007) A New Catheter Operating System for Medical Applications. *Proceedings of the 2007 IEEE/ICME International Conference on Complex Medical Engineering*, pp. 82-87, 2007.
- S. Guo, Tatsuya Nakamura, Toshio Fukuda, Keisuke Oguro, and Makoto Negoro. (1996), Micro Active Catheter Using ICPF Actuator Characteristic Evaluation, *Proceedings of IEEE the 22nd Annual International Conf. on Industrial Electronics, Control, and Instrumentation*, pp.1312-1317, 1996.
- T. Fukuda, S. Guo, K. Kosuge, F. Arai, M. Negoro, and K. Nakabayash. (1994), Micro Active Catheter System with Multi Degree of Freedom, *Proceedings of 1994 IEEE International Conference on Robotic and Automation*, Vol.3, pp. 2290-2295, 1994.
- T. Goto, T. Miyahara, K. Toyoda, J. Okamoto, Y. Kakizawa, J. Koyama, M. G. Fujie, K. Hongo.(2009), Telesurgery of microscopic micromanipulator system "NeuRobot" in neurosurgery: Interhospital Preliminary Study, *Journal of Brain Disease* 2009; 1:45-53.
- X. Wang, M. Meng.(2011), Perspective of active capsule endoscope: actuation and localization, *International Journal of Mechatronics and Automation*, 2011; 1(1):38-45.
- Y. Fu, A. Gao, H. Liu, S. Guo.(2011), The master-slave catheterization system for positioning the steerable catheter, *International Journal of Mechatronics and Automation*, 2011; 1(3), in press.
- Y.C. Wu, J.S. Chen.(2011), Toward the identification of EMG-signal and its bio-feedback application, *International Journal of Mechatronics and Automation*, 2011; 1(2):112-120.

Y. Thakur, Jeffrey S. Bax, David W. Holdsworth and Maria Drangova.(2009), Design and performance Evaluation of a remote catheter navigation system, IEEE Transactions on Biomedical Engineering, Vol.56, No.7, July 2009, pp:1901-1908.

IntechOpen

IntechOpen

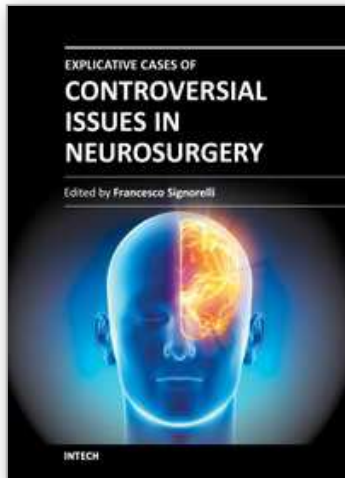

Explicative Cases of Controversial Issues in Neurosurgery

Edited by Dr. Francesco Signorelli

ISBN 978-953-51-0623-4

Hard cover, 534 pages

Publisher InTech

Published online 23, May, 2012

Published in print edition May, 2012

Neurosurgery is a rapidly developing field of medicine. Therefore, staying keeping track of the advancements in the field is paramount for trainees as well as fully trained neurosurgeons. This book, fully available online, is a part of our effort of improving availability of medical information for anyone who needs to keep up-to-date.

How to reference

In order to correctly reference this scholarly work, feel free to copy and paste the following:

Shuxiang Guo, Jian Guo, Nan Xiao and Takashi Tamiya (2012). Robotic Catheter Operating Systems for Endovascular Neurosurgery, Explicative Cases of Controversial Issues in Neurosurgery, Dr. Francesco Signorelli (Ed.), ISBN: 978-953-51-0623-4, InTech, Available from:

<http://www.intechopen.com/books/explicative-cases-of-controversial-issues-in-neurosurgery/robotic-catheter-operating-systems-for-endovascular-neurosurgery>

INTECH
open science | open minds

InTech Europe

University Campus STeP Ri
Slavka Krautzeka 83/A
51000 Rijeka, Croatia
Phone: +385 (51) 770 447
Fax: +385 (51) 686 166
www.intechopen.com

InTech China

Unit 405, Office Block, Hotel Equatorial Shanghai
No.65, Yan An Road (West), Shanghai, 200040, China
中国上海市延安西路65号上海国际贵都大饭店办公楼405单元
Phone: +86-21-62489820
Fax: +86-21-62489821

© 2012 The Author(s). Licensee IntechOpen. This is an open access article distributed under the terms of the [Creative Commons Attribution 3.0 License](#), which permits unrestricted use, distribution, and reproduction in any medium, provided the original work is properly cited.

IntechOpen

IntechOpen