

# We are IntechOpen, the world's leading publisher of Open Access books Built by scientists, for scientists

**4,800**

Open access books available

**122,000**

International authors and editors

**135M**

Downloads

Our authors are among the

**154**

Countries delivered to

**TOP 1%**

most cited scientists

**12.2%**

Contributors from top 500 universities



**WEB OF SCIENCE™**

Selection of our books indexed in the Book Citation Index  
in Web of Science™ Core Collection (BKCI)

Interested in publishing with us?  
Contact [book.department@intechopen.com](mailto:book.department@intechopen.com)

Numbers displayed above are based on latest data collected.

For more information visit [www.intechopen.com](http://www.intechopen.com)



# Ecological Footprint Applied in Agro-Ecosystems: Methods and Case Studies

Alessandro K. Cerutti<sup>1,3</sup>, Gabriele L. Beccaro<sup>1</sup>, Marco Bagliani<sup>2,3</sup>,  
Simone Contu<sup>3</sup>, Dario Donno<sup>1</sup> and Giancarlo Bounous<sup>1</sup>

<sup>1</sup>*Department of Arboriculture, University of Torino*

<sup>2</sup>*Department Territory and Environment, IRES (Istituto di Ricerche Economico-Sociali),*

<sup>3</sup>*IRIS (Interdisciplinary Research Institute on Sustainability), University of Torino*

*Italy*

## 1. Introduction

Covering over a fourth of global land area [1], agriculture has been outlined as one of the most relevant human activities associated with ecosystem degradation. A major cause of environmental impacts from agriculture is due to the high quantity of resource used in terms of water consumption and soil degradation: the Millennium Ecosystem Assessment [1] estimates that 70% of total available water is used in agriculture and the extent of cultivated systems covers 24% of the terrestrial surface. Furthermore, just in the past 100 years, agriculture has been drastically transformed from a resource-based subsistence activity to a highly technological and resource demanding sector. This rapid industrialisation of agriculture, which is based on the use of fossil fuels, produces wastes and residuals that exceed the assimilative capacities of ecosystems and results in alterations to global climate and deterioration of land, air and water in many parts of the world.

This study is motivated by the premise that if agricultural practices degrade ecosystems, they cannot be sustainable, but how can we measure the sustainability of an agricultural system?

In this study some key issues in the evaluation of sustainability of agricultural systems through the Ecological Footprint (EF) approach are discussed. More particularly, the first part gives a brief overview of the sustainability concept and the relation between environmental sustainability and agriculture. The second part introduces the Ecological Footprint Analysis (EFA) from a methodological point of view. The third part discusses the application of the EFA in agriculture through a review of some case studies in food production systems. The fourth part presents a detailed application of the EFA in an original case study, outlining strength and weakness of the method in the specific application. The fifth part briefly describes how this method can be used as a teaching and outreach tool to make students and stakeholders conscious about the ecosystem demand of our food consumption pattern.

### 1.1 Understanding sustainability

Sustainability is a broad concept, sometimes also considered ambiguous because it means different things to different people, at different periods of time. This concept (in its broader

definition) takes its roots in the beginning of the 70's, conventionally with the publication of the book: "The limits to growth" commissioned by the Club of Rome to the research group of Donatella Meadows [2]. In this book, for the first time, scenarios of infinite economic growth in a finite World were presented with all of the problems and misconception of this way of thinking. Nevertheless, the sustainability concept was almost ignored until the end of 80's, when the Brundtland Report was published by the World Commission on Environment and Development [3]. This report describes sustainable development as "the development that meets the needs of the present without compromising the ability of future generations to meet their own needs" [3, page 43]. However, the definition proposed in the Brundtland report does not articulate the concept of "needs" and the mechanisms for achieving a sustainable society. Indeed, after the publication of this report, numerous definitions of sustainability have been suggested, yet none have been universally accepted, contributing to make this concept more misunderstanding.

One of the most consolidated concepts in sustainability is the needing of the three pillars of economy, society and environment simultaneously (fig 1). As a consequence a lot of definitions start with this concept; e.g. the most accepted definition of sustainable agriculture can be summarized as follows: "To be sustainable, a farm must produce adequate yields of high quality, be profitable, protect the environment, conserve resources and be socially responsible in the long term [4].

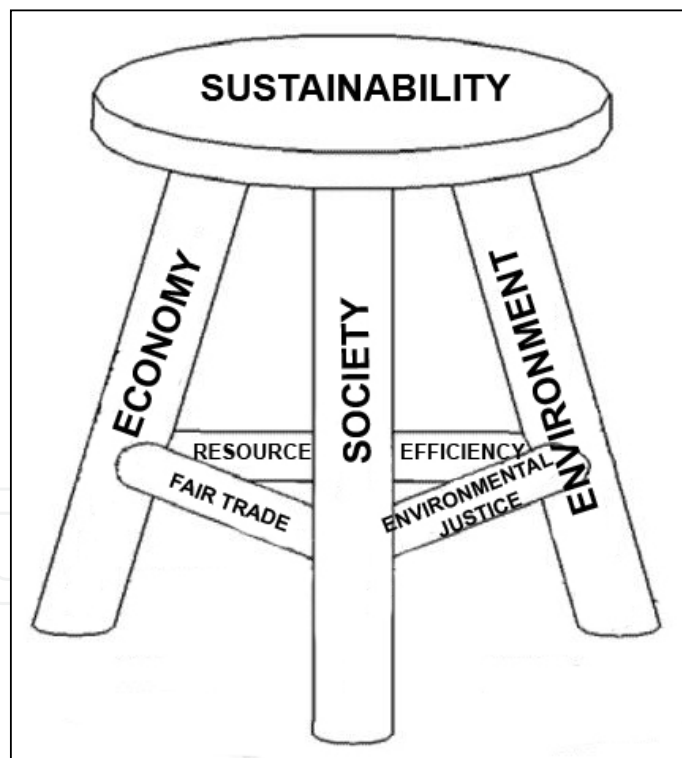

Fig. 1. Graphical representation of the famous metaphor of the "three legged stool" about sustainability. Each of the three legs is a pillar of sustainability: economy, society and environment. Conjunctions of the legs represent aspects that are involved in two pillars simultaneously. For example fair trade considers economy and society, but not environment; resource efficiency considers economy and environment, but not society; environmental justice considers society and environment, but not necessarily economy.

## 1.2 Ecosystem services and agriculture sustainability

Ecological systems both contribute to and are affected by the production of goods and services that contribute to human wellbeing and are of value to people [5]. These positive functions are commonly defined as ecosystem services. As agriculture is one of the dominant drivers for land use change [1], understanding how agriculture impacts ecosystem services is gaining more and more importance in the scientific research.

A number of works [1] [5] [6] outlined the interrelation of agriculture and ecosystem services. Ecosystems provide several direct benefits to agriculture, such as when pollinators increase agricultural crop yields. Nevertheless, most of benefits to agriculture from natural systems are provided indirectly; e.g. intact forests can minimize flooding by slowing snowmelt and water discharge, moderate regional climate, and remove and store atmospheric carbon dioxide, a greenhouse gas. Another example is the service provided by wetlands, which can reduce the load of nitrogen in surface water originating from agricultural fields and destined for a coastal estuary where eutrophication causes hypoxic conditions and reduced fish productivity.

On the other hand, agricultural practices greatly influence ecosystem services both in positive and negative ways. For example a positive effect is the habitat for bird species provided by specific planting on agricultural lands due to conservation policies. Nevertheless, in most cases, agricultural practices reduce the ability of ecosystems to provide goods and services. Main causes of ecosystem damages from agriculture are caused by the use of fertilizers and pesticides, which can increase nutrients and toxins in groundwater and surface waters, contributing to eutrophication of aquatic habitats and degradation of soils. Moreover, agricultural outputs to ecosystems may change species composition or reduce biodiversity, which may also affect negatively the production of goods and services, because the ability of ecosystems to provide some services depends both on the number and type of species in an ecosystem.

Furthermore, ecosystems degraded by agricultural practices may generate significant disservices back to agricultural systems [5]. For example habitat loss in areas located nearby agricultural fields, may no more provide the conditions for completing the life cycle of insects useful for natural pest control. Thus, pest damages to the production may increase, inducing farm technicians to amplify pesticides doses, which lead to more significant damages to habitats nearby the farms. As a consequence, it can be easily pointed out that negative effects on ecosystems are actually negative effects on the agricultural systems themselves. Thus the obtaining of a conservative agriculture is one of the main aims of modern agronomic research.

One of the most important issues of a conservative management of farms is the obtaining of a sustainable yield; nevertheless it is highly difficult to define and measure what sustainable yield is [7] [8]. Nowadays it is well known that yield is affected by a number of parameters, both natural, such as the pedo-climatic conditions, and artificial such as the agricultural techniques and growing structures. Clearly all of the agricultural practices (such fertilization, irrigation, heating of greenhouses etc...) contribute both the yield and to the environmental burden of the production. The difficulty is to evaluate a trade-off between positive and negative effects, considering also that those agronomic parameters have

usually a combinatory effect on the crop, which does not reflect the sum of the effects of single agricultural practice alone.

Considering these general remarks, some authors [9] state that the coming 50 years as the final period of the rapidly expanding human environmental impacts on the global scale, because future agriculture (with all the other human activities) will modify, perhaps irreversibly, ecosystem services obtained from the global bio-geological cycles. Nevertheless, if environmental concern are mostly focused on the global scale, the possible actions for mitigate negative effects can be done on the local scale. Thus better understanding of how to achieve sustainability at the farm level is important because at this level a lot of changes can be made in productive protocols and technologies to reduce the environmental impacts of farming activities. As a result, practical assessment of sustainability at the field level is one of the essential points in order to achieve the sustainability of the whole food and fibre industry and, therefore, to mitigate environmental impacts on the global scale.

## **2. The ecological footprint in a nutshell**

Since the publication of the Limit to growth [2] in the early '70, it is well known that services provided by ecosystems are limited. Even if a limitless growth is still the main objective of public policies in most countries, the scientific debate on the extent to which human development can be maintained in the light of environmental constraints is still vital and prolific.

During the last decades of the XX century several tools and indicators have been developed to measure the impact of production and consumption of goods and services to human systems in order to give indications of behaviours and lifestyles more compatible with the finiteness of the natural resources. One of such method is the Ecological Footprint Analysis (EFA) which estimates the total area of the terrestrial and aquatic ecosystems necessary to supply all resources utilized and to absorb all resultant emissions needed to sustain a human population or in the production of particular products. EFA provides a single value (hectares or global hectares) that comprises of various environmental burdens and which can be disaggregate down to the most detailed level of the single consumption. The aggregation capability of the EFA thus enables easy comparison of results arising from different scenarios.

Results of EFA are generally expressed in global hectares (gha) which represent a productivity-weighted area used to report both the demand on ecosystem services and the biocapacity of the Earth. In order to convert effective land surface into global hectares equivalence factors (EQF) have been introduced [10]. These factors are corrections of the land components based on the different productivities of each land type; therefore the gha unit gives a standardized and productivity-weighted value of the EFA results [11].

The continuous development of the analytical methods by various research groups around the world led to Wackernagel and collaborators to create in 2004, the Global Footprint Network (GFN), a network of research institutions, scientists and users of EFA which aims improve the calculation methods.

## 2.1 The land components

The original EFA method was introduced by [12] and further developed by [10]. In the original definition just 4 land components were considered:

- i. Cropland: is the land needed to grow all crop products, including livestock feeds, fish meals, oil crops and rubber. It is the most bioproductive of the land use types considered by in the GFN standards.
- ii. Forest land: is the land needed annually to harvest fuel wood and timber to supply forest products. The yield used in the forest land component in the GFN standards is the net annual increment of merchantable timber per hectare, accounted on the base of the production quantities of 13 primary timber products and three wood fuel products [11].
- iii. Built-up land: is the land covered by all type of human infrastructure, such as houses, commercial buildings, industrial structures but also streets and concrete covered lands. This type of land, even if the smaller component on the global scale [11], is quite important because it is assumed that built-up land is a transformed cropland which lost its original biocapacity.
- iv. Energy land: is the land needed to produce and to absorb emissions caused by the use of energetic carriers, such as fossil fuels, electricity and renewable energy. In the original calculation the consumption of 80-100 GJ from fossil fuels was equivalent to 1 hectare of energy land [10].

In more than 20 years from the original formulation several improvements have been performed and land components of the EFA have been revised. More particularly two land components have been added:

- v. Grazing land (or pasture): measures the area of grassland used in addition to crop feeds to support livestock. It can be considered as a more detailed definition than cropland for the evaluation of the land needed for animal products. More particularly grazing land comprises all grasslands used to provide feed for animals, including cultivated pastures as well as wild grasslands and prairies.
- vi. Fishing grounds: is the area surface (as a simplification of volume) required to sustain a harvested aquatic species. Also this land type can be considered as a better qualification for the EFA of food products. It is accounted as the surface need to sustain the mass ratio of harvested fish based on its average trophic level.

Furthermore, the energy land component was deeply revised and updated to the Carbon Footprint component. This land type quantifies the land needed to absorb the carbon emissions from all activities: from production of goods to waste management. As most terrestrial carbon uptake in the biosphere occurs in forests, and to avoid overestimations, carbon uptake land is assumed to be forest land by the EFA method [11].

Recently, a new way of considering EF land components has been proposed [13]. Considering the life cycle of a product, a part of the EF is due to the direct land use, such as the crop growing for food products, and a part of the EF is due to the energy which is embedded in the use of materials and services. The embedded energy can be accounted as the carbon footprint needed to produce and to absorb emission from that source, thus this land can be considered as used indirectly in the life cycle of a product. As consequence a novel formulation of the EF component is the following:

$$EF = EF_{\text{direct}} + EF_{\text{CO}_2} \quad (1)$$

where  $EF_{\text{direct}}$  represents land occupation over time by cropland, built-up land, pasture and forest. This value is counted as the sum of the area occupied by each land type, multiplied by the specific land-related Equivalence factor (EQF). These factors are land specific coefficients that correct the land components on the base of the different productivities of each land type, taking into consideration the average productivity of all the bioproductive areas on Earth. The second component of the footprint ( $EF_{\text{CO}_2}$ ) is the indirect bioproductive land required to sequester, through forestation, the atmospheric fossil  $\text{CO}_2$  emissions related to the produced goods. This value is obtained by multiplying the product-specific emission of  $\text{CO}_2$  by the EQF of forests and the mass of  $\text{CO}_2$  sequestered in biomass with a correction of the  $\text{CO}_2$  absorbed by oceans [14].

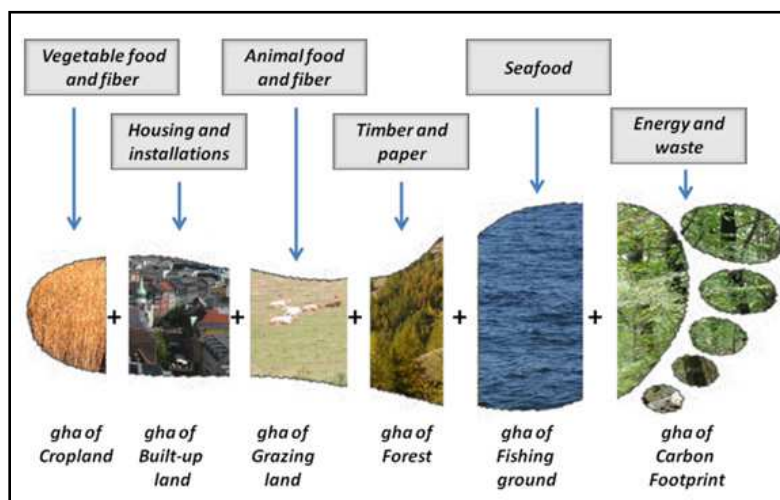

Fig. 2. Schematic representation of the EF land components associated to main goods and services (modified from the GFN).

## 2.2 Main applications of the EFA

Since the early definition, several changes have been applied in order to being able to perform the EF approach in a number of systems.

The EF method applied to the national scale is also known as the National Footprint Account. This method is standardized by the GFN and, in its last application, it calculates the EF and biocapacity for more than 200 countries and the World [11]. These accounts are published biennially in the WWF's Living Planet Report and are based on the latest complete datasets available, which results usually in a time lag of about three years.

The National Footprint method consists in the quantification of the total production and consumption at the national level. The EF of production, which represents primary demand for biocapacity, is calculated as the amount of a product produced in the Country, divided by the national average yield (or production capability) and then multiplied for the yield factor and the specific EQF. The EF of consumption is obtained starting with the EF of production, summing the EF embodied in imported commodity flows and subtracting EF embodied in exported commodity flows. Even if this method reveals just the apparent

consumption, it is considered a sufficient approximation of international trade, because data on stock changes for various goods are generally not available [11].

Furthermore, even if the National Footprint Accounts recognized as one of the best tools to assess the ecosystem demand of countries, data and methodological issues associated with the calculation remain [15]. Main concerns are related to the quality and the country specificity of data source as main data used for the evaluation are obtained from international datasets.

Considering EF applications at the sub-national scale several authors have outlined the potentialities of the EFA in measuring the environmental demand of regions and districts (e.g. [16][17]). For these kinds of application a number of data, which are generally available at a national level, are actually difficult to obtain at the regional and at the local level. Therefore, in the whole calculation method for a sub-national area are generally considered the data available at the commune level [17]. Indeed at this level, it is usually possible to find data regarding different kinds of consumptions such as housing (electricity, gas, and fuel oil), water, waste production and land occupation. Another possibility is to calculate the average consumptions for each commune of a district by weighting the average regional consumptions on the basis of the composition of each commune by employment conditions [16].

Relatively recent applications of the EFA can be found at the company or at the product levels. In the first case some adaptation of the original EF method are proposed (e.g. [18][19]). In these implementations the EFA is usually joined to other economic assessment tools in order to enhance the industrial metabolism of the studied company. The modified EF methods are therefore able to quantify economic flows of a company from an environmental point of view.

On the other hand, methods for the EFA of products are, in most cases, based on the Life Cycle approach used in LCA studies. E.g. [20] proposed to account the EF of a product as the sum of the EF of the process involved in the production. More detailed, the authors suggest to consider impacts related to the materials used during the production; the land occupied, with the account of biodiversity and productivity impacts, labour embedded impacts and waste management impacts. As a consequence some authors [13] considered the EFA of a product, more than a standalone tool, as a specific life cycle impact assessment (LCIA) method, which gives results on a single impact category (land use expressed in gha) instead of different impact categories with specific measure units (such as Global Warming Potential in kg of CO<sub>2</sub> equivalent). Furthermore [13] compared results from EF and Eco-Indicator 99 (single score) and they found that for a large number of products both methods will typically produce the same type of gross ranking results, but not for all products considered in the study. Nevertheless authors suggested that EFA and Eco-Indicator 99 results can get closer if some additional impacts will be taken into account in the EFA, such as tacking in account the complete GHG emission instead of just CO<sub>2</sub>.

Another important general issue in the EFA is the evaluation of waste. From an EF perspective, the term waste includes three different categories of materials, thus three different waste management protocols that are differently assessed in the EFA [21]. The first type are biological wastes such as residues of crops and livestock effluents: these materials are already included in the specific land category (cropland for the first and pasture for the second) as the recycling of organic matter in an ecosystem service already accounted in the



quantification of such land component. Thus the addition the CO<sub>2</sub> emitted from the decomposition of vegetable and animal residues will lead to a double accounting. The second type are the wastes sent to landfill: these materials are accounted as the infrastructure of the built-up land used for its long term storage as these landfills occupy formerly biologically productive areas. The third waste type are the toxic and pollutant materials that cannot be absorbed in any kind of biological cycle. As the EFA quantify the area needed to the production process of a specific product or to absorb a waste, materials such as plastics which are not part of a biological cycle, have to be accounted just indirectly as the carbon footprint generated by the energy embodied in the production cycle of a specific quantity of material. As a conclusion, the energy embodied within goods (both locally produced and imported) plays a major role in the determination of the total EF in all the EF methods [22], thus robust country-specific embodied energy data to capture the carbon embodied in traded good are needed. These kinds of data have historically been lacking [22], nevertheless with the increasing interest on the carbon footprint methodology to achieve environmental sustainability of consumption and production, more detailed datasets could be available soon.

### 3. Key-issues in the EFA in agro-ecosystems

As the EFA was developed to assess the ecosystem demand of a given population, the focus of EF of production processes is a relatively new aspect and a complete review of the application of EFA in the agricultural sector has not yet been performed.

For the agricultural sector, three land types are considered sufficient to describe the land composition of the EF of farms [23][24]: cropland, which accounts for the effective land surface where the farm is assessed and for production of animal feeds which were not produced on-farm; forest, which accounts for production of forest resources such as wood for piling; and carbon footprint which accounts for the land required to produce the non renewable energy used on the farm and for the production of the farm inputs.

Nevertheless another land component might be relevant: the built-up land, which accounts for considers the land occupied by infrastructure, e.g. deposit, garages, silos and other structures [25].

Furthermore, some studies [27] consider also the pasture land and the sea area which result when including in the application also the EF of the operators. This approach is still under debate because it is a matter of fixing the system boundaries of the application: those workers would have consumed foods and natural resources regardless their activity in the crop field, thus their environmental impacts are not an externalities of the production. But, on the other hand, when comparing different scenarios (e.g. production protocols such as conventional and organic production) it can be noticed that a scenario might require less labour than another thus the impact of the workers might be decisive in the determination of which scenario has the worst EF. Further investigations are needed to assess definitively this issue.

Typically the EFA of crops is conducted in order to give reference values for the National Footprint Accounts. In this account the EF is evaluated on the basis of the average yield of a species and the national consumption [11][27] or using the conventional global hectare approach [22]. In this case the quantification of the EF of a food item can be simplified in the following equation:

$$EF_{(gha)} = \frac{C_{nation}}{Y_{world}} \times EQF \quad (2)$$

were the EF is obtained dividing the annual tonnage of the food consumption by the annual average global yield and then multiplying by the cropland equivalent factor, which is 2.39 [11]. To this value it has to be added the energy intensity of the production, given by the incorporation of the required energy-land for the supply of cultivation inputs, such as fertilizers, pesticides and machinery. Such parameters are considered as the average requirement for the crop and are usually obtained by international databases such as FAOSTAT and FERTISTAT. This method suffers in the localization of the production, because at different pedo-climatic conditions the EF of the same crop can be very different, thus a place-oriented quantification is suggested [28].

Another example is the National Footprint Accounts' footprint for fruits which is considered to be 0.5–0.6 gha per ton of product on the basis of average global yield, embodied energy of the cultivation and estimation of the impacts of post-harvest management [27]. Thus the EF of imported fruits account simply for the average soil required for the production and the energy for transportation to the imported country.

These rough estimation methods of the EF of crops could be useful for the application of EFA at the large scale, but it is obviously insufficient for detailed applications. Indeed, using general methods, for agricultural products typically 80% of the total EF is clarified by the occupation of land by crops [13], on the contrary, applications with a specific process approach (e.g. [25][26]) reveal that crop land accounts for less than 30% of the total EF and the major role is played by the carbon footprint. As a consequence, different approach may lead to different results and, thus, to different suggestions for improving the studied production system.

### 3.1 The objective of case studies

The agricultural systems are not, generally, the direct object of an EFA. The environmental pressures generated by human activities in agro-ecosystems are evaluated as a component of the food production systems. More detailed, four main types of case studies for EFA in the agricultural context can be found in the scientific literature:

#### 3.1.1 The EFA of crops

As highlighted in paragraph 1.2, crops are production systems, which utilize ecosystem services to produce commercial goods that are directed to the anthropo-sphere. Further than direct ecosystem services, growers utilize industrial inputs, such as fertilizers and pesticides, and capital goods, such as machineries and infrastructures. All the inputs utilized in the production are involved in the determination of the EF of such production. Thus EFA of crops can be considered a product EFA from a biological based production system instead of a product from an industrial based production system. This difference, which might seem to be small because of the high industrialization of modern agriculture, is however important to be considered in modelling of system for environmental assessment applications. The main difference with industrial systems is that crop production is strongly bounded to specific pedo-climatic conditions which means that crop yields may change dramatically from one year to the other, because different wheatear conditions or because of

uncontained pest infections. Being bounded to local conditions also means that in other countries, natural and technical inputs applied in field in order to obtain the same level of production, may vary dramatically in quantity and way of using. As a consequence environmental impacts of crops systems vary greatly from a Country to another and regionalized data are required for precise applications of an environmental impacts assessment tool [29].

A detailed EFA application to crop productions can be found in [30]. Authors applied EFA and other tools on six agricultural crop production systems in Nicaragua: common bean, tomato, cabbage, maize, pineapple and coffee. In this study the EFA included the cropland as well as the machinery and buildings appropriated for the cultivation; resource use was assessed in four land type: (I) the actual cropping area, (II) the built-up area used for cropping purposes and (III) the area for sequestration of carbon dioxide as a consequence of direct and indirect energy use for purchased inputs and in transportation, as well as for labour and other services. Furthermore, (IV) an estimated area appropriated for biological conservation was added.

Applications of the EFA on crops are conducted generally using a mass based functional unit, thus results are commonly presented in EF per tonnes of production and expressed in gha/t (e.g. [24] [25] [26] [31]). Nevertheless other ways to express results are proposed and may lead to different conclusions (see paragraph 3.3).

### 3.1.2 The EFA of food products

In this case the EFA is mainly conducted as an EFA of product in which the investigated product is a result of biological and industrial production processes. It has to be noted an important distinction between the EFA for primary agricultural products, such as wheat or vegetables, and the EFA for secondary transformed food products, such as pasta or already-prepared soups. In the second case the production reflects an industrial process which is mainly linear and it could be very different to a biologically base production. Detailed study on such kind of production should consider both the field and the industrial phase (e.g. [32]).

The EF of food products is often referred to the land required for the final commercial unit (such as a 1 kg box of pasta or a 250 g jar of jam) instead of a ton of primary production from the field. A detailed application of the EFA to an agricultural product has been performed by [26], in which authors applied a product EFA to two typical Tuscan wines, one conventional and one organic, to determine which type of wine production present the greater environmental burden. They considered four production phases: (I) agricultural, i.e. preparation and planting of the vineyard, grape; (II) production, treatments and harvest; (III) winery, i.e. crushing, fermentation and stabilization; (IV) packing, i.e. bottling, corking and labelling; and the distribution phase. Thus they set the reference flow for the environmental impacts to 1 bottle of wine. Their results showed that higher EF value is obtained for conventional compared to organic production. This was mainly due to the higher demand in the agricultural phase, which contributed most to the EF value of both productions.

Furthermore, the EFA has been used as one environmental assessment method (together with Carbon Footprint and Water Footprint) for the Environmental Product Declaration (EPD) of several cereal-based products from the Barilla Company [29]. In the EPD of pasta

the agricultural phase accounts for almost the 49% of the whole product EF, the industrial phase (which comprehends: elaboration, packaging and distribution) accounts for 9%, and the consumer phase (which comprehends the impact of cooking) accounts for 42% of the whole product EF. Beside the application in the agricultural context, this study highlights also the good potential for EFA as an environmental certification tool as the base for EPDs of food products.

### 3.1.3 The EFA of farms

Several authors consider the farm as a good level of application of an environmental assessment method (e.g. [23] [24] [29]). Results of environmental impact assessments applied to a farm are related exclusively to the farm and cannot be used extrapolated for compare different crops or different production protocols without specific modifications in the method [24]. Nevertheless several studies use the farm level in order to assess the performance of an environmental assessment method (e.g. [23] [24] [33]). In such studies several impact assessment methods are applied to the same farm (or the same farm scenarios) in order both to discuss results and evaluate the method.

Recently the application of EFA on farms was deeply discussed and some corrections have been proposed [34] in order to account negative environmental externalities of farms, such as the decrease of soil fertility, soil erosion and biodiversity loss. Authors decided to account such effects trough an economic quantification of each externality and then the relative valorisation in term of emergetic values (seJ/year) as suggested by [35].

Other authors [36] claim that in order to apply the EFA at the level of farm or company, the economic transactions (such as the cost of capital goods and services) has to be accounted from the environmental point of view. Thus some methods are proposed to incorporating the Input-Output methodology in the EFA (e.g. [36] [37]). Another method for evaluate the economic performance of the company from an environmental point of view is proposed by [19] with the joint implementation of EFA and Cost Accounting. In their approach, the production chain is divided in several activity centres that best reflect both the generation of impacts on ecosystems and the process of economic value production. The environmental pressures of the different activity centres are represented in term of their appropriation of ecological productive land following the EFA accounting system [10] [11]. Results of this method showed the high level of accuracy obtained in EF calculation; more particularly in the application in two livestock farms it was possible to capture small differences in ecological footprint due to little variations of the productive process, depending on the slightly different utilization of mechanised breeding techniques [38].

Although some methodological aspects that are still under debate, according to most studies, the EFA applied on farm is an interesting level of analysis because it allows to visualize the virtual land needs of a farm, including direct and indirect resources use, and may guide technicians and growers to strategy for reduction of the EF of their farms.

### 3.1.4 The EFA of diets

Another object of application of EFA in the context of food production and agro-ecosystem consumption is the environmental impact evaluation of the diet of a given population. Also

in this level of analysis several methods are proposed, but the EFA is one of the most used for didactical and divulgation purposes because of the easy way of calculation via the National Footprint Matrix [11] and because of the easy understanding of the results. Several example of application of EFA to a food consumption patter may be found in scientific reports for NGOs (e.g. [39]) or Research Institutes (e.g. [40]) as well in scientific literature (e.g. [41]). All these studies highlight that the food consumption patterns that are more environmental friendly are also the healthiest. This effect can be observed by the role that meat products play in the evaluated consumption patterns; more particularly [32] stated that, in comparison with the current Scottish diet, a healthier diet can reduce the Scottish EF by between 15 and 20%.

These studies reveal that eating mainly fruit, vegetables and wholegrain foods, and moderate amounts of meat, dairy and eggs is not only good for us but also better for the environment. On this topic [42] defined the double pyramid metaphor which represents that the most consumed foods in a healthy diet (such as seasonal vegetables and fruits) are the items with the lower EF and vice versa the food with the higher EF values (such as beef, cheese and butter) should be consumed very rarely for a healthy diet.

### 3.2 EFA and scenario evaluation

The main scope of the EFA is to quantify numerically the ecosystem demand of a population or a product and the obtained EF result may be used in several ways. The most important application is the comparison of the EF of a population and the biocapacity of the ecosystems where the population is located in order to assess whether a population is able or not to live with just their own resources (e.g. [10]). Nevertheless a relevant application of EFA results is in scenario comparison of production processes, because its ability to aggregate several environmental impact sources in a single coherent value.

In the agricultural sector the EFA as a tool for scenario evaluation is conducted at two level with two main scopes: at the field level, in order to identify of the best agricultural practice (e.g.[43][44]) and at the farm level in order to identify which production protocol shows the best environmental performance (e.g. [38][45]). Thus the EFA can be considered as one of the available tools to identify best agricultural practice for sustainable food production [7].

The study from [43] was not only one of the first studies in EF in the agricultural sector, but also one of the first EF applications of all time, thus it is considered a very important step in the development of the method. In this study the environmental impacts of tomato production in some hydroponic greenhouses and open fields are compared thorough the EFA. All agricultural inputs, energetic carriers and direct land use for four different scenarios (two greenhouse systems and two open field systems) have been accounted. With the hydroponic systems is it possible to obtain a big amount of product because the higher yield of the system (an average of 465 t/ha compared to an average of 70 t/ha in open field systems). Thus one may think that hydroponic systems are more sustainable because they can produce an higher amount of product for the same occupied land, but considering the EF result, the hydroponic approach required a 14 to 21 times higher EF than conventional farming to produce the same amount of tomatoes. This difference reflects the different

resource use intensity of each agricultural technique, thus the requirement of ecosystem services that is embodied in the use of each agricultural input [32].

A recent application of EFA for the evaluation of the best agricultural techniques has been performed by [44]; in this case the effects of different fertilization methods in an Italian nectarine orchard have been assessed. The study represents also one of the first applications of a statistical evaluation of the EFA results in order to assess if different EF values of each scenario are statistically significant or not. It was possible to perform the statistical analysis because of the dataset collected directly on the orchard during an agronomic trial with a randomized block design set up for performing the Analysis of Variance (ANOVA). The randomized block design considered three replications of four treatments has been applied: liquid slurry (LS), covered slurry (CS), solid fraction (SF), mineral nutrition (MN). Each of these treatments has been modelled in a scenario considering also two different alternatives in swine manure disposal (MN1, MN2). All the agricultural inputs for each scenario has been collected directly on field and the total EF of each system has been referred to the unit of production (more detailed, the considered functional unit was gha/t of nectarine produced). The ANOVA results showed that different total EF values reflect statistical significant differences among systems and Tukey's Test indeed highlighted three statistical classes: the first composed by LS, CS, SF systems which total ecological footprint is not significant different among each other (average 0.96 gha/t); the second is composed just by the MN2 system which has the highest ecological footprint (1.14 gha/t) and the third with the MN1 system which has middle-value (1.01 gha/t) but present significant differences with all the other systems. Thus, using the ANOVA it was possible to define mathematically that differences in the EF of the fertilization systems with manure are non significant among themselves but are significantly lower (about 15%) in respect to the other fertilization systems. Without the application of a statistical method it would not be possible to assess such result.

Moreover, [45] performed a detailed application of the EFA to the production of different Brazilian boiler feed production scenarios. The authors designed the scenarios as a small matrix of different feeds and their sources. They choose this method in order to assess the different environmental characteristics existing in the grain produced in different region of Brazil. Applying the EFA to the resulted scenarios they were able to identify the environmentally best combination of production protocol and product source, but also which were the most problematic aspects of the supply chain from the environmental point of view.

Another important issue in the application of EF for scenario analysis is the recurring concept that foods with lower EF can be considered more sustainable (e.g. [39]). Following this theoretical framework, differences in EF values represents the quantification of the sustainability of a scenario in comparison to another one and can be used to quantify precisely the advantage of a specific agro-technique among the others. Thus differences in EF values for each scenario can be used as an objective basis for discussion of policies for promoting techniques or production protocol. E.g. the value of 1.07 gha, found by [26] as the difference in the EF of two wine production scenarios, can be considered the numerical quantification of the sustainability of the organic protocol (1.12 gha/t) in relation to the conventional protocol (2.19 gha/t).

### 3.3 The choose of the functional unit and the efficiency problem

As highlighted in previous paragraphs EFA results may be expressed in several ways in relation to different functional units. The use of the term functional unit is not proper for the EFA method, but it is originally used in LCA studies. Nevertheless as further applications of EFA to products are more frequently using a life cycle approach [13], the LCA nomenclature can be adapted. Thus the term functional unit in the EFA refers to the measure unit under which are related the environmental impacts of the whole production process. In particular, the most used functional units in the application of environmental impact assessment tools in the agricultural sector are:

- i. mass based functional units, in which the environmental impacts are related to a specific amount of products produced. In EFA applications typical mass based functional unit are tones of product, and generally results are expressed in gha/t or gm<sup>2</sup>/kg. This category is the more common in EFA because it is immediately understanding and also because being the unit used in the first studies of EFA of products.
- ii. Product based functional units, in which the ecosystem demand is related to a single final item of the production process. This unit is used when the final product is made of different materials with different production or transformation processes, such as cardboard and wheat for a box of pasta [32] or glass and grapevine for a bottle of wine [26].
- iii. Land based functional units, in which the environmental impacts are related to a specific amount of land directly involved in the production. This category is not commonly used in EFA, partly because land use is not directly a service and does not provide a productive function; nevertheless it can give very interesting results. Results of EFA using such method are expressed in global hectares per cultivated hectares allowing the visualisation of the difference between the area occupied by the crop field and the total area used considering all upstream processes [26][30] expressed in global hectares (gha).
- iv. Economic-value based functional units, in which ecosystem demands are related to the economic value of the products produced. Results are expressed in global hectares per unit of income, usually 1000 € or 1000 USD. This functional unit is useful when the economic eco-efficiency of the systems is to be optimised [46], but it is up to now rarely applied in EFA of foods.
- v. Nutrient based functional unit, in which the ecosystem burden is related to the amount of a specific nutritional characteristic bound in the final product. This is a typical unit of food products because it allows to compare foods with very different characteristics on a common parameter. For example in feed production, wheat and soy are really different products with different characteristic, thus relating the environmental impacts of their production to a mass may mislead results. On the other hand wheat and soy are both used for feeding livestock mainly for their protein content, thus a protein-based functional unit may allows to better relating the environmental impacts of the two production systems. [30] mixed EM and EFA in an evaluation of environmental burdens related to the production of a calorific unit in fruits, and thus their unit is gha/Gcal.

As a general remark, [24] outlined that the mode of expression of results (for the whole farm, per unit area, or per unit product) strongly affects the rankings obtained. E.g., the mass based functional unit is easy to comprehend and widely used, but carries the problem of over-evaluating efficiency within sustainability research. By simply looking at environmental impacts per unit product, it is possible to evaluate the eco-efficiency of production, but it is not possible to estimate the sustainability of such production because efficiency does not necessarily lead to sustainability. Indeed, in their paper, [31] underline that only using mass based functional units may well lead to a preference for high input-high output systems, which, when concentrated at regional scale, have been shown to cause major pollution problems [24]. Furthermore, when using a mass based functional unit, problems may arise in how to account for different food quality [47]. E.g. in fruit production, the same orchard can usually produce fruit of different quality (e.g. size, colour, firmness or sugar content) that is targeted to different markets (e.g. fresh market or industrial processing). This issue should be considered in the definition of the functional unit and an allocation procedure relating the environmental impacts to the different products which are consistent with the goal of the study should be devised [47].

On the other hand, the use of a land based functional unit allows to quantify the impacts of cultivating a certain area with a specific agricultural technique. This parameter is also called the impact intensity of a farm [46]. Nevertheless, using a land based functional unit alone may well lead to a preference for low input-low output systems, which may decrease impacts at regional level, but may create a need for additional land use elsewhere, giving rise to additional impacts [24].

As a general result the recommended method of application is to present results using a matrix of EFA with multiple functional units [30]. In this study several functional units have been considered in order to evaluate crops from different point of view: due to this method it was possible to highlight that crops may show difference environmental performance with different parameters: e.g., in the revenue based functional unit cabbage was the crop with by far the least area needed to generate an income of 1000 USD (0.7 ha/1000USD), while pineapple, the crop with the largest EF, required more than nine times as large an area as cabbage (6.5 ha/1000USD). When comparing the EF to produce 1 Gcal, maize and beans were the most favourable crops, with the lowest EF (0.17 and 0.23 gha/Gcal, respectively) and tomato the least, with a five times higher value (1.0 gha/Gcal). The index obtained with the use of a land based functional unit shows that growing beans on 1 ha resulted in the smallest additional area (2.4 gha/ ha crop), while on the other hand, tomato and cabbage required the highest (6.5 and 7.5 gha/ha crop, respectively).

## **4. A focus case study: The orchard**

### **4.1 The environmental demand of fruit production systems**

Fruit production is considered an agricultural sector with low environmental impacts in comparison to other food sectors [40] [48]. Some studies (e.g. [41]) highlight that fruit production requires less bioproductive land compared to all animal products because livestock needs both direct land for breeding and land for feed production. [49] shows that some fruit systems may be less impacting from the environmental point of view than some



open field crops; nevertheless quantification of the sustainability of fruit production is required to make specific considerations and comparisons.

When evaluating the environmental burdens in fruit production it is very important to remember the differences between the open field crop systems (where assessment tools are mainly applied) and the perennial crops [47]. There are several differences between these two systems that are related mainly to the impossibility of removing the orchard at the end of the year. Indeed, pests and diseases that are host-tree permanent may remain in the orchard for many years and require continuous control. Due to this effect, orchards are among the most intensively sprayed agricultural systems, in order to avoid visible and internal fruit damage and to satisfy international commercial quality standards [50]. The main environmental risks relating to the use of conventional pesticides are the negative effects on the animal and plant communities exposed both in the orchard and in the other terrestrial and aquatic ecosystems to which pesticides are lost [51]. Another important environmental aspect associated with pesticide use that has to be considered is the resource consumption and environmental impacts associated with the production and distribution of synthetic pesticides. [52] found that pesticide use represents up to 20% of total energy consumption in integrated apple production in New Zealand. Furthermore, because of the development of resistant strains of some pests, there is a tendency for increased frequency of treatments [50] and for increased application rates (around 500 L per ha) in order to retain more pesticides on the leaves and the fruits.

Another key difference between annual and perennial crop is soil management. The operations aimed to maintain and improve soil quality (such as fertilization, irrigation and weed management) are obviously different in the two systems, but in both cases they play a major role in the determination of the environmental impacts of the production [25].

#### **4.2 The importance of a systemic view of the orchard**

According to systems thinking, the component parts of a system can be better understood through their relationships with each other and with the environment, rather than in isolation (e.g. [53]). An agricultural system can be defined as a group of interacting components, operating together for a common purpose, capable of reaching as a whole to external stimuli; it is unaffected directly by its own outputs and has a specified boundary based on the inclusion of all significant feedbacks [54].

Various authors are proposing that system thinking is necessary in order to achieve the understanding of the system dynamics which is necessary for proper assessment of the sustainability of the production in agricultural systems (e.g. [55] [56]). The principal reason for this is that agricultural systems are complex, and therefore, it is not possible to modify a single component without generating effects on the other components of the systems. A second important reason is that sustainability is an interdisciplinary issue which requires complex models and multidisciplinary analytical tools.

Most of the papers on the application of an environmental impact assessment method in fruit production describe the orchard from a thermodynamic point of view. They consider the orchard system from interactions that it has with the natural environment in which it is embedded. Thus, orchards are considered systems, which constantly interact with the environment through the use of energy and materials across the boundary (fig 3).

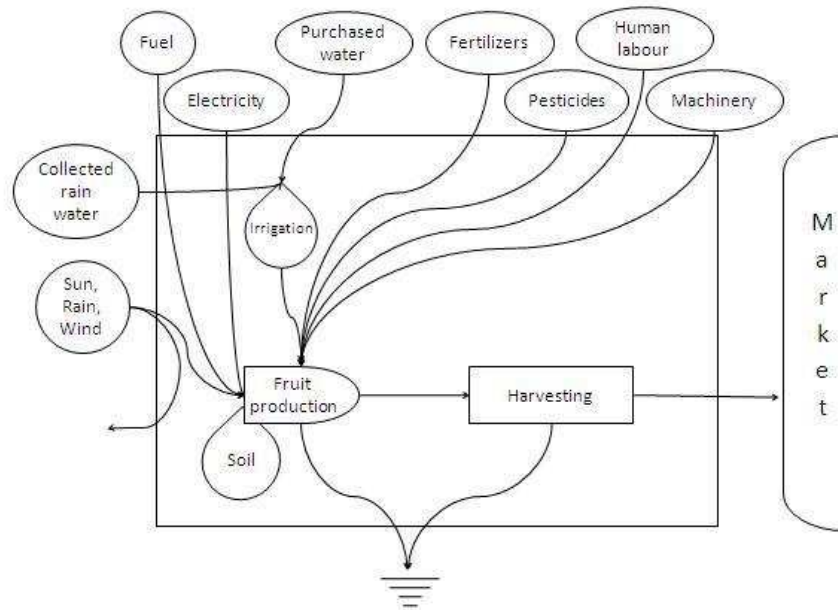

Fig. 3. General energy system diagram of an orchard. This diagram is commonly used for Energy Analysis and represents the fruit production system from a thermodynamic point of view.

Another way of modelling orchards is by considering interactions instead of energy flows. From a systemic point of view, fruit production can be seen as the integration of various systems (fig 4).

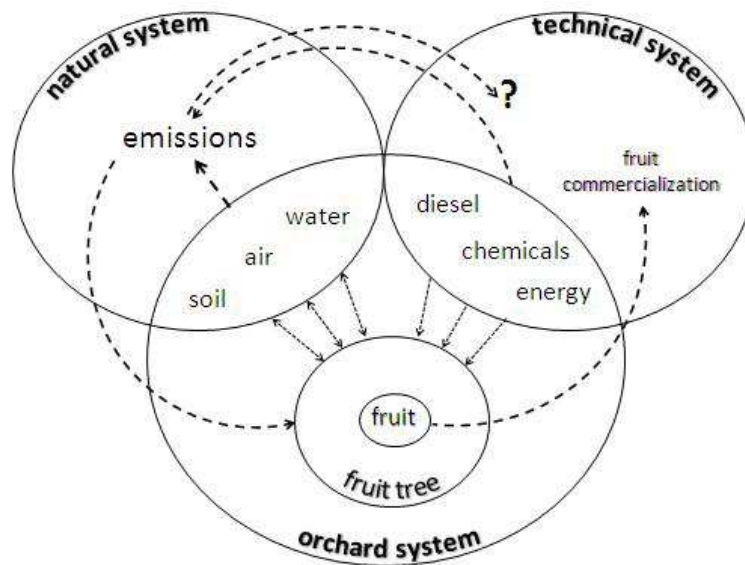

Fig. 4. One of the possibly representations of the orchard from a systemic point of view modified from Page (2009). Orchards are at the same time part of natural system and part of technical system, but they are also a system themselves with subsystems (e.g. fruit trees). Interfaces components of the three systems are represent with common areas of the three cycles and arrows are interactions between components. “Emissions” comprehends all kind of emissions, in water, soil and atmosphere.

In order to model the fruit production, three systems have to be considered: the natural, the technical and the orchard itself. The natural system can be simplified as the biotic and abiotic components of the environment in which the orchard is embedded. The interfaces between natural and orchard systems are mainly soil, air and water (as a local part of pedosphere, atmosphere and hydrosphere). Furthermore, the orchard system is dependent on several ecosystem processes provided by biotic components (see paragraph 1.2).

As system theory suggests, all systems are in fact components of still larger systems and all components of systems are in fact systems made up of still smaller components [56]. For example, fruit trees are at the same time components of the orchard system and systems themselves. More precisely fruit tree sub-system is the core of the orchard system, because effects of natural and technical systems can be seen mostly at the plant level [55].

It is important to underline that when using a systems thinking approach, almost all the processes transferring matter or energy from one system to another produce effects (expected or unexpected) in the other systems. The expected feedbacks of the inputs from technical system into the orchard are the production of fruits and income, but there are also effects on the natural system with the production of different emissions. Studying the chain of effects within the natural system may be very complicated (e.g. [57]), but in the end it is well known that changes in the natural system will affect the orchard and technical systems.

As a consequence, applying system thinking to orchard system allows highlighting connections with related systems and becoming conscious of environmental boundaries that have to be considered for a sustainability assessment.

Experts of system theory underlined that from one system to another there are flows (or cycles) of various forms of energy, matter and information. Looking at orchard systems, different flows of information can be seen. Probably the most important information flow is the genetic, carried with the choice of the cultivar, but from an environmental point of view a key information flow is represented by agricultural practices. Farmers constantly choose the type of orchard management among their knowledge, thus productive protocol and orchard design can be considered as expression of information flows. This information flow may play an important role in determining the environmental burdens of the orchard. For example [58] identified a significant correlation between orchard design and input management. Particularly they found that low density apple orchards required more water but less P-fertilizer per hectare.

Another example of the importance of considering the whole orchard system for sustainability is the shift to high-density plantings of dwarf rootstock trees [49] in integrated fruit production. Low canopy height decrease the use of machinery and a more open canopy helps reduce some diseases and improves pesticide coverage and efficacy.

Furthermore, apart from rare studies in the past decade (e.g. [51]), the application of system thinking to orchards is just at the beginning and new research paradigms have to be investigated. A recent study highlighted the inefficiency of plot based studies in orchards for assessing fruit quality, landscape patterns and sustainability [58]. The authors suggested that splitting orchards in plots was necessary to understand the bases of fruit production in the past decades, but the plot concept will no longer be useful to meet the future challenges, because the plot concept is unable to catch the complexity of the orchard system.

### 4.3 Example of application in apple production: methods

As described in the previous paragraph, orchards are complex biological productive systems. In order to obtain reliable environmental assessments in orchards, instead of considered only the one-year field operations, all the impacts related to the entire lifetime of the orchard have to be accounted. One of the direct consequences is that some resources are used annually whilst others are present during the whole lifetime of the orchard thus a multiple-stage model of the orchard has to be considered. [47] suggested a 6 stages model that has been tested and validated by [25]. The model comprehends 6 different stages during the overall fruit production (nursery through to orchard removal) and point out that all the stages contribute to the environmental burden of the system even if just the main orchard stages actually produce fruit to the market.

Therefore, in this EFA application, we distinguish and evaluate the impacts of each of the following stages:

*Stage 1 (ST1).* Nursery stage (accounted for 2 years). This stage was evaluated as the average processes and resources needed to obtain rootstocks, scions and finally young plants.

*Stage 2 (ST2).* The establishment stage (occurs just one time). This stage was evaluated as the common practice of removing previous installation and preparing the field for the orchard. Plastic, steel, wood resources and energy for the orchard installation have been added in proportion to the lifetime of the orchard.

*Stage 3 (ST3).* Low yield production due to young plants (accounted for 3 years). This stage includes all the one-year field operation (see ST4) but all impacts and resource use are proportioned to a reduced production due the youth of the plants.

*Stage 4 (ST4).* Full production (accounted for 13 years). This stage includes all the one-year field operation, particularly:

- tree management: this category comprises of operations aimed to improve orchard productivity, facilitate harvest and prevent disease proliferation [47].
- pest and diseases management: pesticide applications, usually by air-blast spraying several times per season
- understorey management: the management of the soil between the rows seeks to prevent competition for water or nutrients with the trees and erosion [52].
- irrigation: trees received water through drip pipe irrigation directly under the tree canopy. This system requires pumping systems that consumes electricity.
- weather damage prevention: hail prevention nets were installed, opened and closed once per season, with two field crossings by hydra-ladder.

*Stage 5 (ST5).* Low yield production due to declining plants (accounted for 2 years). This stage includes all the one-year field operation (see ST4) but all impacts and resource use are proportioned to a reduced due the old age of the plants.

*Stage 6 (ST6).* The destruction of the orchard (occurs just one time). This stage was mainly accounted for machinery and fuel.

Thus, the system boundary of the model includes production of differentiated apple farming inputs and their transport to the field, fuel and electricity use during nectarine farming, nursery, orchard installation and destruction (fig 5).

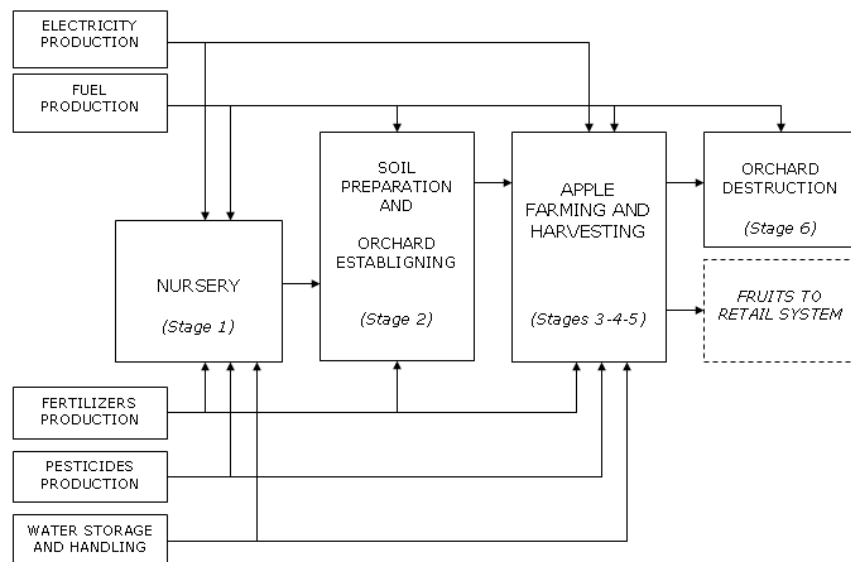

Fig. 5. System boundary and modelling of the apple production phase. Dotted box refers to processes are not included in the application.

The data collection was made in a commercial apple (*Malus domestica* Borkh var. Golden Delicious) orchard in Cuneo province, Northern Italy, managed according to the Italian Integrated Fruit Production (IFP) protocol. Impacts and resources use for all of the farming operations were obtained directly on field during years 2009-2010. All other information required (e.g. nursery impacts and resources use) were collected through questionnaire to the related growers and specialized field technicians.

Following information provided from the owner of the orchard in the field registry, the yield of each year has been collected, but instead of the real value we decided to consider an average yield as well an average resource use of agricultural inputs. The average yield has been assessed as 29.48 t/ha (fig 6). Considering local pedoclimatic conditions, agrotechniques and cultivar the average yield in the low-yield years (ST3, ST5) has been modelled as 20 t/ha (fig 6).

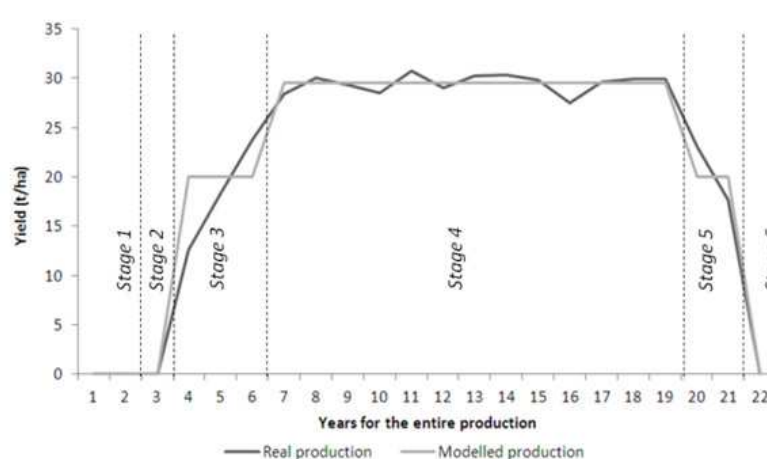

Fig. 6. Real and modelled production of the investigated apple orchard through its whole lifetime.

Regarding the EFA method, a product EFA was applied, with the following formula:

$$EF_{\text{product}} \left( \frac{\text{gha}}{\text{t}} \right) = \frac{(\sum_{\text{st1-st6}} EF_{\text{direct}}) + (\sum_{\text{st1-st6}} EF_{\text{CO}_2})}{\sum_{\text{st1-st2}} \text{Yield}} \quad (3)$$

in which the sum of the gha required for each production stage (counted once for each year of incidence in the production) gives the total land required and the sum of the yield of each stage for each year of incidence is the total yield of the orchard in its lifetime. Total land required (gha) on total yield gives the footprint of 1 t of nectarine produced.

As highlighted in previous paragraphs, the use of different functional units may be useful to compare different production from several points of view. In this application just one production is considered and the use of different functional units is necessary, nevertheless, a further EF method was applied in order to highlight some potentialities of the evaluation. The second functional unit used was a land-based unit (1 hectare of orchard) applying this formula:

$$EF_{\text{land}} \left( \frac{\text{gha}}{\text{gha}_{\text{farm}}} \right) = \frac{(\sum_{\text{st1-st6}} EF_{\text{direct}}) + (\sum_{\text{st1-st6}} EF_{\text{CO}_2})}{\text{Area}_{\text{farm}} \times EQF_{\text{cropland}}} \quad (4)$$

in which the whole EF of the productive system is divided by the biological carrying capacity of the farm, given by the multiplication of the real hectares of the farm by the Equivalence Factor of cropland. Using this method all the environmental impacts are related to the use of 1 ha of orchard and it will be possible to evaluate the extra land needed per each ha of the farm needed to maintain the production.

#### 4.4 Example of application in apple production: Results and discussion

The  $EF_{\text{product}}$  of the investigated system was 1.59 gha/t apple produced. The footprint land-components were distributed as follows: cropland 7.5%, built-up land 0.01%, forest 0.18%, energy land 92.55%. The built-up land and the forest land percentages are very low (less than 0.2%), and they are confirmed as irrelevant in the EFA of fruit, at least in the production stages. Indeed further application of the method to the whole fruit commercial system (production, transformation, packaging and distribution) is required to extend this remark to the whole supply-chain.

Considering the incidence of the direct and indirect land use in the whole production system  $EF_{\text{direct}}$  accounts for 11.27% and  $EF_{\text{CO}_2}$  accounts for 88.73%. The latter indicator states the indirect land use as a proxy of the energy applied in the production system. This energy is applied in various forms: not only electricity and diesel, but also the embodied energy in chemical material (e.g. fertilizers and pesticides) and all the other resources. Without using such additional energy the productive system would have a lower yield (e.g. product lost from pest attacks or from lower fertilization). Thus the  $EF_{\text{CO}_2}$  can be considered as an indicator of the energy intensity production protocol applied to the system in order to amplify the productivity.

Specific incidence of the  $EF_{\text{direct}}$  and the  $EF_{\text{CO}_2}$  per each stage to the whole production system is presented in fig 7, in terms of total gha of that stage divided by the total tonnage of apple produced from the orchard across all years.

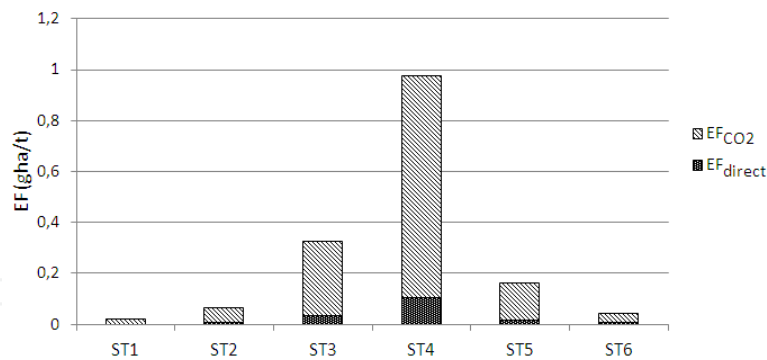

Fig. 7. Comparison of the direct and indirect contribution in the EF results accounted by the mass based functional unit: tonnes of apple produced at the farm gate.

Among the stages involved in apple production, ST4 (operations and resources for production high yield years) has, as expected, the highest footprint value: 61.17% of the overall footprint. The other stages make substantially lower contributions to the overall impact, specifically: ST1=1.34%, ST2=4.02%, ST3=20.52%, ST5=10.26%, ST6=2.68%.

This study confirms that the gaps suggested by other authors [47] and evaluated in previous works [25] can be significant. In the case study, the ST4 (high yield field operations and resources use) contributes to almost 62% of the footprint of the whole system; therefore the other stages in total contribute to about 38% of the footprint. The impact from the stages that occur just one time (ST1, ST2, ST6) have a relative small contribution to the total EF (about 8%), nevertheless, we have to consider that the impact of such stages is spread over the lifetime of the orchard, thus in absolute term is actually relevant.

These results suggest that applying the EFA only to the high yield production, as presently proposed (e.g. [26] [30]) will probably underestimate the real footprint in some situations, depending on the production protocol. More studies are required to verify the average gap for each fruit species; when these data are available, consideration of all stages in the application of EFA (and other environmental or sustainability indicators) is strongly advised.

Further interesting remark may arise from the use of the second method: the  $EF_{land}$  of the entire production system was 13.61 gha/gha<sub>farm</sub>, and the proportion of the footprint land-component was the same as the EF obtained with the mass based functional unit. Assuming that all land needed for the production of agricultural inputs may be accounted as cropland, it is possible to transform the  $EF_{land}$  to real hectares, using the EQF for cropland given by [11]. The result is 5.15 ha/ha<sub>farm</sub>. This value means that for each real hectare of the farm, 5.15 hectares are needed (directly and indirectly) to support the production. Thus it is possible to assess that the specific production protocol weight globally on the ecosystem services for 5 times the land in which it is applied.

## 5. EFA for education

Beside the use of the scientific results obtained with EFA for improving agro-techniques and developing policies, one of the most important aspects of this tool is the educational outreach. EFA results are easy to be understood and relatively easy to be translated in lifestyle patterns.

Recently [59] conducted a study in order to assess whether tracking the EF of a family in its daily life consumption pattern may encourage a more sustainable behaviour at the household level. Their research started from the statement that inability to measurably personalize the link between global unsustainable consumption and individual lifestyles is a main factor of stopping the changing towards a more sustainable. Thus they assessed the EF of 18 families in the UK, throughout a number of questionnaires and EF results were given back to the family members in order to increase their environmental awareness of their own lifestyle. Then, intended and actual changes in EF, as a reflex of changes in consumption patterns, were evaluated. Authors assessed a significant reduction of the household EF once families become aware of their own ecosystem burdens, thus they stated that EFA can be used successfully to inspire reductions in the environmental impacts of individuals.

The EF tool, in various forms, can also be applied in schools; indeed the WWF Switzerland describes several didactic units with a simplified EFA application [60]. In these units students are brought to think about their consumption pattern in terms of ecological burden of their behaviour. For this type of application a precise quantification of the EF of items or services used is not really necessary, what is very important is to highlight clearly that some consumption behaviours required more ecosystem services than others. E.g. in the EF board game [60], eating apples costs 1 footprint-point and eating meat everyday costs 6 footprint-points; probably more detail on the evaluation of such points should be given, but the important thing is that students are able to understand the difference in the environmental burden. Another interesting case study of EFA in school is the research performed by [61]. Authors developed a didactic research letting students apply EFA to their own school in Israel during years 2008-2009. The educational program consisted of two components: (1) a theoretical, interdisciplinary component based on content material from the fields of the social sciences and ecology and (2) a practical part that included the calculation of the EF of the school and exploring ways to reduce it. Looking at the results of their study, food and electricity consumption are the major components of the school's EF and transportation is the smallest component because most students either walk to school or use public transportation. From the educational point of view, authors highlight that the EFA can be an important educational tool in order to help students understand the linkage between behavioural choices and their impact on the ecological systems. Furthermore, EFA also enables students to think critically about the choices they make and the environmental consequences of those choices and to take the opportunities and responsibilities they have as members of a larger community for active participation and collaboration in moving toward sustainability [61].

Another EFA's ability is the efficient communication of the notion that any society depends on ecosystem services that might be beyond its local bio-capacity and that natural goods and services needed to support human systems might be located virtually everywhere in the World. While part of any population's ecological footprint is placed on domestic sources, uneven global distribution of population and natural resources combined with economic growth, processes of economic integration (i.e., globalization) and increasing international trade imply that the ecological footprint of any society is increasingly placed on ecosystems beyond its own boundaries [28]. Thus the EFA helps to act locally, in a specific system, but also to think the environment on a global scale. In order to highlight the dependence of human system on ecosystem services on the global scale several metaphors and tools have



been developed. One of the most significant tools is the Earth Overshoot Day, developed by the GFN. This calculation allows to identify the day on which the global EF (measured in global hectares) is equal to the Earth carrying capacity (also measured in global hectares) that nature can regenerate in that year (for a detailed description of the method see the [62]). For the rest of the year, we are accumulating debt by depleting our natural capital and letting waste accumulate. Thus the identification of the day of the overshoot of ecosystem services helps conceptualize the degree to which we are over-budget in our use of nature, but also it allows to visualize the size of the gap between a sustainable level of ecological demand and how much is currently required to support human activities globally.

## 6. Conclusion

As can be easily seen through proposed literature and researches, sustainability of agricultural systems is becoming more important and sustainability assessment methods continue to evolve. Indeed sustainability is considered one of the most pressing and urgent challenges that agriculture is facing today. The need for research and education to meet this challenge has been identified in almost every recent study on agricultural research needs. More specifically, it is often outlined that nowadays we need a new agriculture that more nearly mimics the structure and function of natural ecosystems (e.g. [63]).

In order to assess the sustainability of an agricultural system in a quantitative manner, indicators which are consistent with the criteria for sustainability are required. There are several studies of direct and indirect environmental assessed methods in food production, in which a multitude of assessment methods has been applied to a large variety of systems, nevertheless just with the use of few indicators the relation to sustainability can be assessed.

The most common methods applied for evaluating environmental impacts of agriculture may be different concerning various aspects, for example: the global objective, the set of environmental issues considered the definition of the system boundaries, the considered functional unit and the calculation algorithms. Therefore, standardization of research methods and protocols when applying environmental assessment methods in food production is needed, otherwise result may be impossible to compare from system to system. Being able to compare the results from different studies would be important also in order to identify sustainability threshold, as suggested by several authors (e.g. [64]).

As a general result of the research and taking into account that any discussion of sustainable agriculture depends on the context [49], EFA can easily discriminate the environmental burdens of each component of the system of the specific case study. Therefore, in food production, the EFA could help to improve one of the three aspects of sustainability (ecology, economic and social). However, although the ecological footprint is an indicator easy to understand, it is not an indicator easily applied by non-experts; thus the application of EFA directly by field technicians should only be considered when utilizing a pre-constructed and standardized sheet of calculation.

Thus, like various authors (e.g. [24]), we recommend that environmental evaluation methods should be used with great caution, considering which method is most appropriate given the specific study case.

## 7. References

- [1] Millennium Ecosystem Assessment (MA), 2005 Synthesis, Island Press, Washington DC (2005) <http://www.maweb.org> (last access 22.11.2010).
- [2] D.H. Meadows, D.L. Meadows, W.W. Behrens, J. Randers, E.K.O. Zahn, *Limits to Growth*, Universe Books, New York, 1972.
- [3] WCED (World Commission on Environment and Development): *Our Common Future* ("Brundtland-Report"), Oxford University Press, 1987.
- [4] J.P. Reganold, P.K. Glover, P.K. Andrews, H.R. Hinman, "Sustainability of three apple production systems". *Nature*, vol 410, pp. 926-929, 2001.
- [5] V.H. Dale, S. Polasky, "Measures of the effects of agricultural practices on ecosystem services" *Ecological Economics*, vol. 64, pp. 286-296, 2007.
- [6] W. Zhang, T.H. Ricketts, C. Kremen, K. Carneyd, S.M. Swinton, "Ecosystem services and dis-services to agriculture" *Ecological Economics*, vol. 64, pp.253-260, 2007.
- [7] J. Ferng, "Local sustainable yield and embodied resources in ecological footprint analysis—a case study on the required paddy field in Taiwan" *Ecological Economics* vol.53, pp.415- 430, 2005.
- [8] Z. Móznér, A. Tabi, M. Csutora, "Integrating the environmental impacts of agriculture into the Ecological Footprint methodology" in *9th International Conference of the European Society for Ecological Economics*, Boğaziçi University, Istanbul 2011.
- [9] D. Tilman, K.G. Cassman, P.A. Matson, R. Naylor, S. Polasky, "Agricultural sustainability and intensive production practices", *Nature*, vol. 418, pp. 671-677, 2002.
- [10] M. Wackernagel, W. Rees, *Our ecological footprint: reducing human impact on the earth*. New Society Publishers, Gabriola Island, BC, 1996.
- [11] B. Ewing, W. Reed, A. Galli, J. Kitzes, M. Wackernagel, *Calculation Methodology for the National Footprint Accounts, 2010 Edition*, Oakland: Global Footprint Network, 2010.
- [12] W.E. Rees, "Ecological footprints and appropriated carrying capacity: what urban economics leaves out" *Environment and Urbanization*, vol. 4, pp.121-130, 1992.
- [13] M.A.J. Huijbregts, S. Hellweg, R. Frischknecht, K. Hungerbuhler, A.J. Hendriks, "Ecological footprint accounting in the life cycle assessment of products" *Ecological Economics*, vol. 64, pp. 798-807, 2008.
- [14] C. Monfreda, M. Wackernagel, D. Deumling, "Establishing national natural capital accounts based on detailed Ecological Footprint and biological capacity assessments" *Land Use Policy*, vol. 21, pp. 231-246, 2004.
- [15] Risk & Policy Analysts Ltd., *A review of recent developments in, and the practical use of, ecological footprint methodologies: A report to the Department for Environmental Food and Rural Affairs*, Defra, London, 2007.
- [16] L. Lewan, C. Simmons, *L'impronta ecologica e l'analisi della biocapacità come indicatori di sostenibilità per le aree geografiche subnazionali*, Rapporto Finale Progetto Indicatori Comuni Europei EUROCITIES, 2001.
- [17] M. Bagliani, A. Galli, V. Niccolucci, N. Marchettini "Ecological footprint analysis applied to a sub-national area: The case of the Province of Siena (Italy)", *Journal of environmental management*, vol. 86, pp. 354-364, 2008.
- [18] M. Lenzen, S. Lundie, G. Bransgrove, L. Charet, R.F. Sack, *A novel ecological footprint and an example application*. ISA research paper 02-02, University of Sydney, 2002 <http://www.isa.org.usyd.edu.au/publications/documents/SydneyWaterFootprint.pdf> (accessed 20.07.11).

- [19] M. Bagliani, F. Martini, "A joint implementation of ecological footprint methodology and cost accounting techniques for measuring environmental pressures at the company level", *Ecological Indicator*, doi:10.1016/j.ecolind.2011.09.001
- [20] E.A.M. Limnios, A. Ghadouani, S.G. Schilizzi, T. Mazzarol, "Giving the consumer the choice: A methodology for Product Ecological Footprint calculation" *Ecological Economics*, vol. 68, pp. 2525–2534, 2009.
- [21] J. Kitzes, M. Wackernagel, "Answers to common questions in Ecological Footprint accounting", *Ecological Indicators*, vol. 9, pp. 812–817, 2009.
- [22] J. Kitzes, A. Galli, M. Bagliani, J. Barrett, G. Dige, S. Ede, K. Erb, S. Giljum, H. Haberl, C. Hails, S. Jungwirth, M. Lenzen, K. Lewis, J. Loh, N. Marchettini, H. Messinger, K. Milne, R. Moles, C. Monfreda, D. Moran, K. Nakano, A. Pyhälä, W. Rees, C. Simmons, M. Wackernagel, Y. Wada, C. Walsh, T. Wiedmann, "A Research Agenda for Improving National Ecological Footprint Accounts", in *the International Ecological Footprint Conference – Stepping up the Pace: New Developments in Ecological Footprint Methodology, Policy & Practice*, Cardiff, Wales, United Kingdom, 2007.
- [23] M.A. Thomassen, I.J.M. de Boer, "Evaluation of indicator to assess the environmental impact of dairy production systems" *Agriculture, Ecosystems and Environment*, vol. 111, pp. 185–199, 2005.
- [24] H.M.G. Van der Werf, J. Tzilivakis, K. Lewis, C. Basset-Mens, "Environmental impacts of farm scenarios according to five assessment methods", *Agriculture, Ecosystems and Environment*, vol. 118, pp. 327–338, 2007.
- [25] A.K. Cerutti, M. Bagliani, G.L. Beccaro, G. Bounous, "Application of Ecological Footprint Analysis on nectarine production: methodological issues and results from a case study in Italy" *Journal of Cleaner Production*, vol. 18, pp. 771–776, 2010.
- [26] V. Niccolucci, A. Galli, J. Kitzes, M.R. Pulselli, S. Borsa, N. Marchettini, "Ecological footprint analysis applied to the production of two Italian wines" *Agriculture, Ecosystems and Environment*, vol. 128, pp. 162–16, 2008.
- [27] N. Chambers, C. Simmons, M. Wackernagel, *Sharing nature's interest: ecological footprint as an indicator of sustainability*. Earthscan Publications Ltd., London and Sterling, VA, 2000.
- [28] M. Kissinger, D. Gottlieb, "Place oriented ecological footprint analysis – The case of Israely grain supply" *Ecological Economics*, vol. 69, pp.1639–1645, 2010.
- [29] L. Milà i Canals, A. Azapagic, G. Doka, D. Jefferies, H. King, C. Mutel, T. Nemecek, A. Roches, S. Sim, H. Stichnothe, G. Thoma, A. Williams, "Approaches for Addressing Life Cycle Assessment Data Gaps for Bio-based Products" *Journal of Industrial Ecology*, vol. 15, pp. 707–725, 2011.
- [30] M. Cuadra, J. Bjorklund, "Assessment of economic and ecological carrying capacity of agricultural crops in Nicaragua" *Ecological Indicators*, vol. 7, pp.133–149, 2007.
- [31] M. Wackernagel, W. Rees "Perceptual and structural barriers to investing in natural capital: Economics from an ecological footprint perspective" *Ecological Economics*, vol. 20, pp. 3–24, 1997.
- [32] L. Ruini, L. Campra, M. Marino, A. Filareto, M. Bagliani, S. Contu, "Ecological Footprint as large-scale pasta producer Key Performance Indicators (KPI). The State of the Art in Ecological Footprint Theory and Applications" in *Proceeding of the Footprint Forum 2010*, Siena (Italy), pp 133–134.

- [33] A.K. Cerutti, M. Bagliani, G.L. Beccaro, C. Peano, G. Bounous "Comparison of LCA and EFA for the environmental account of fruit production systems: a case study in Northern Italy" in *Proceedings of the VII International conference of life cycle assessment in the agri-food sector*, 2010, vol 2, pp. 99-104.
- [34] F. Agostinho, J.R. Siche, E. Ortega, "True ecological footprints for small farms in Brazil" in *Proceedings of the International Ecological Footprint Conference*, Cardiff, Wales, UK, 2007.
- [35] S. Zhao, Z. Li, W. Li "A modified method of ecological footprint calculation and its application" *Ecological Modelling*, vol. 185, pp. 65-75, 2005.
- [36] T. Wiedmann, J. Barrett, "A review of the ecological footprint indicator - perceptions and methods" *Sustainability*, vol. 2, pp. 1645-1693, 2010.
- [37] J. Ferng, "Using composition of land multiplier to estimate ecological footprints associated with production activity" *Ecological Economics*, vol. 37, pp. 159-172, 2001.
- [38] M. Bagliani, M. Carechino, F. Martini, *La contabilità ambientale applicata alla produzione zootecnica. L'Impronta Ecologica dell'allevamento di bovini di razza piemontese*. Collana Ambiente, Regione Piemonte, Torino, 2009.
- [39] D. Deumling, M. Wackernagel, C. Monfreda, *Eating up the Earth: How Sustainable Food Systems Shrink our Ecological Footprint*. Redefining Progress, 2003, Available at: <http://www.rprogress.org> (27.03.09).
- [40] S. Frey, J. Barrett, *The Footprint of Scotland's diet: the environmental burden of what we eat. A report for Scotland's Global Footprint Project*. Stockholm Environment Institute, 2006.
- [41] P. W. Gerbens-Leenes, S. Nonhebel, "Consumption patterns and their effects on land required for food", *Ecological Economics*, vol. 42, pp. 185-199, 2002.
- [42] Barilla CFN *The double pyramid: Healthy food for people, sustainable for the planet*. Supporting technical paper, 2011, <http://www.barillacfn.com/> (15.09.2011).
- [43] Y. Wada, *The appropriated carrying capacity of tomato production: comparing the ecological footprints of hydroponic greenhouse and mechanized field operations*, Ph.D. Thesis. University of British Columbia, 1993.
- [44] A.K. Cerutti, M. Bagliani, G.L. Beccaro, F. Gioelli, P. Balsari, G. Bounous, "Evaluation of the sustainability of swine manure fertilization in orchard through Ecological Footprint Analysis: results from a case study in Italy", *Journal of Cleaner Production*, vol. 19, pp. 318-324, 2011.
- [45] F. de Alvarenga, V.P. da Silva, R. Soares, "Comparison of the Ecological Footprint and a life cycle impact assessment method for a case study on Brazilian broiler feed production" *Journal of Cleaner Production*, doi: 10.1016/j.jclepro.2011.06.023
- [46] P. Mouron, T. Nemecek, R.W. Scholz, O. Weber, "Management influence on environmental impacts in a apple production system on Swiss fruit farms: combining life cycle assessment with risk assessment" *Agriculture, ecosystems and environment*, vol. 114, pp. 311-322, 2006.
- [47] L. Milà i Canals, G. Clemente Polo, "Life cycle assessment of fruit production" in: Mattsson B., Sonesson U., *Environmentally friendly food processing*. Woodhead Publishing Limited and CRC Press LLC, Cambridge and Boca Raton, 2003, pp. 29-53.
- [48] A. Carlsson-Kanyama, M.P. Ekstrom, H. Shanahan, "Food and life cycle energy inputs: consequences of diet and ways to increase efficiency" *Ecological economics*, vol. 44, pp. 293-307, 2003.

- [49] D. Granatstein, E. Kupferman, "Sustainable horticulture in fruit production", *Acta Horticulturae (ISHS)*, vol. 767, pp. 295-308, 2006.
- [50] S. Simon, J. Bouvier, J. Debras, B. Sauphanor, "Biodiversity and pest management in orchard systems. A review", *Agronomy for sustainable development*, vol. 30, pp. 139-152, 2009.
- [51] S.R. Gliessman, *Agroecology. The ecology of sustainable food system*, CRC press, Taylor and Francis Group, 2006.
- [52] L. Mila i Canals, G.M. Burnip, S.J. Cowell, "Evaluation of the environmental impacts of apple production using Life Cycle Assessment (LCA): Case study in New Zealand" *Agriculture, Ecosystems and Environment*, vol. 114, pp. 226-238, 2006.
- [53] L. Von Bertalanffy, *General System Theory: Foundations, Development, Applications*, Eds George Braziller Inc, New York, 1976.
- [54] C. Spedding, *An introduction to agricultural systems*, London Elsevier Science Publications, 1988.
- [55] G. Page, *An environmentally-based systems approach to sustainability analyses of organic fruit production systems in New Zealand*. PhD Thesis. Massey University, Palmerston North, New Zealand, 2009.
- [56] J.E. Ikerd, "The need for a system approach to sustainable agriculture" *Agriculture, ecosystems and environment*, vol. 46, pp. 147-160, 1993.
- [57] M. Hauschild, "Spatial Differentiation in Life Cycle Impact Assessment: A decade of method development to increase the environmental realism of LCIA" *The International Journal of Life Cycle Assessment*, vol. 11, pp.11-13, 2006.
- [58] T. Nesme, F. Lescourret, S. Bellon, D. Plenet, R. Habib, "Relevance of orchard design issuing from growers' planting choices to study fruit tree cropping systems" *Agronomie*, vol. 23, pp. 651-660, 2003.
- [59] M. Sutcliffe, P. Hooper, R. Howell, "Can Eco-Footprinting Analysis Be Used Successfully to Encourage More Sustainable Behaviour at the Household Level?" *Sustainable Development*, vol. 16, pp. 1-16, 2008.
- [60] WWF Switzerland, didactic materials.  
[http://www.wwf.ch/it/fare/essereattivi/formazione/scuola/materiale didattico/impronta\\_scuola.cfm](http://www.wwf.ch/it/fare/essereattivi/formazione/scuola/materiale didattico/impronta_scuola.cfm) (15.09.2011)
- [61] D. Gottlieb, E. Vigoda-Gadot, A. Haim, M. Kissinger, "The ecological footprint as an educational tool for sustainability: A case study analysis in an Israeli public high school" *International Journal of Educational Development*, vol. 32, pp.193-200, 2012.
- [62] Global Footprint Network, overshoot day description  
[www.footprintnetwork.org/earthovershootday/](http://www.footprintnetwork.org/earthovershootday/) (15.09.2011)
- [63] W. Rees "The eco-footprint of agriculture: A far from (thermodynamic) equilibrium interpretation" in *Agricultural Biotechnology: Finding Common International Goals*, National Agric. Biotech. Council, Ithaca, NY 2004, pp. 87-110.
- [64] H.M.G. Van der Werf, J. Petit. "Evaluation of the environmental impact of agriculture at the farm level: a comparison and analysis of 12 indicator-based methods," *Agriculture, ecosystems and environment*, vol. 93, pp. 131-145, 2002

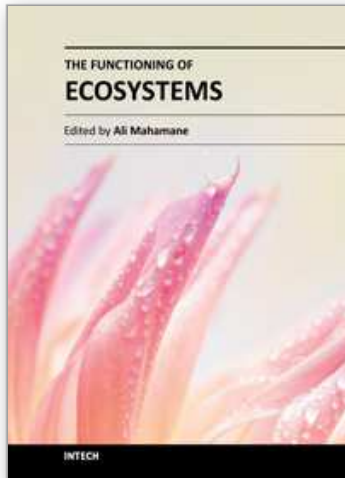

## **The Functioning of Ecosystems**

Edited by Prof. Mahamane Ali

ISBN 978-953-51-0573-2

Hard cover, 332 pages

**Publisher** InTech

**Published online** 27, April, 2012

**Published in print edition** April, 2012

The ecosystems present a great diversity worldwide and use various functionalities according to ecologic regions. In this new context of variability and climatic changes, these ecosystems undergo notable modifications amplified by domestic uses of which it was subjected to. Indeed the ecosystems render diverse services to humanity from their composition and structure but the tolerable levels are unknown. The preservation of these ecosystemic services needs a clear understanding of their complexity. The role of the research is not only to characterise the ecosystems but also to clearly define the tolerable usage levels. Their characterisation proves to be important not only for the local populations that use it but also for the conservation of biodiversity. Hence, the measurement, management and protection of ecosystems need innovative and diverse methods. For all these reasons, the aim of this book is to bring out a general view on the biogeochemical cycles, the ecological imprints, the mathematical models and theories applicable to many situations.

### **How to reference**

In order to correctly reference this scholarly work, feel free to copy and paste the following:

Alessandro K. Cerutti, Gabriele L. Beccaro, Marco Bagliani, Simone Contu, Dario Donno and Giancarlo Bounous (2012). Ecological Footprint Applied in Agro-Ecosystems: Methods and Case Studies, The Functioning of Ecosystems, Prof. Mahamane Ali (Ed.), ISBN: 978-953-51-0573-2, InTech, Available from: <http://www.intechopen.com/books/the-functioning-of-ecosystems/ecological-footprint-applied-in-agro-ecosystems-methods-and-case-studies>

**INTECH**  
open science | open minds

### **InTech Europe**

University Campus STeP Ri  
Slavka Krautzeka 83/A  
51000 Rijeka, Croatia  
Phone: +385 (51) 770 447  
Fax: +385 (51) 686 166  
[www.intechopen.com](http://www.intechopen.com)

### **InTech China**

Unit 405, Office Block, Hotel Equatorial Shanghai  
No.65, Yan An Road (West), Shanghai, 200040, China  
中国上海市延安西路65号上海国际贵都大饭店办公楼405单元  
Phone: +86-21-62489820  
Fax: +86-21-62489821

© 2012 The Author(s). Licensee IntechOpen. This is an open access article distributed under the terms of the [Creative Commons Attribution 3.0 License](#), which permits unrestricted use, distribution, and reproduction in any medium, provided the original work is properly cited.

IntechOpen

IntechOpen