

# We are IntechOpen, the world's leading publisher of Open Access books Built by scientists, for scientists

4,800

Open access books available

122,000

International authors and editors

135M

Downloads

Our authors are among the

154

Countries delivered to

TOP 1%

most cited scientists

12.2%

Contributors from top 500 universities



WEB OF SCIENCE™

Selection of our books indexed in the Book Citation Index  
in Web of Science™ Core Collection (BKCI)

Interested in publishing with us?  
Contact [book.department@intechopen.com](mailto:book.department@intechopen.com)

Numbers displayed above are based on latest data collected.

For more information visit [www.intechopen.com](http://www.intechopen.com)



# Tunable Dual-Wavelength Laser Scheme by Optical-Injection Fabry-Perot Laser Diode

Chien-Hung Yeh

*Information and Communications Research Laboratories,  
Industrial Technology Research Institute (ITRI), Chutung, Hsinchu,  
Taiwan*

## 1. Introduction

Tunable and stable multiwavelength fiber lasers are important and attractive in recent years because of their potential applications in wavelength-division-multiplexed (WDM) technique (Das et al., 2002; Slavik et al., 2002), optical code-division multiple-access (OCDMA) technique (Barmenkov et al., 2008; Alvarez-Chavez et al., 2007), fiber sensor system (Chou et al., 2008; Chen et al., 2007), and optical instrument measuring (Talaverano et al., 2001; Nilsson et al., 1996) and testing (Liu et al., 2004; Li et al., 1998). Different techniques for the reduction of wavelength competition have been used to achieve stable multiwavelength oscillations. However, the homogeneous gain broadening of erbium-doped fibers (EDFs) would lead to the wavelength competition [2]. Many previously reports have been focused on the fiber laser technique by inserting the optical filter, such as the tunable bandpass filter (Barmenkov et al., 2008), Fabry-Perot tunable filter (Li et al., 1998) and fiber Bragg grating (Alvarez-Chavez et al., 2007), into the EDF laser cavity for single or multiwavelength oscillations (Chen et al., 2007). In such configurations, the cavity losses corresponding to the different wavelengths have to be balanced with the cavity gains simultaneously. Therefore, it is difficult to control the lasing wavelength output.

Recently, the self-injection Fabry-Perot laser diodes (FP-LDs) and distributed feedback laser diode (DFB-LD) with mode-locked operation using Bragg grating or optical filter to generate tunable single-wavelength (Schell et al., 1995), dual-wavelength (Kim et al., 2005; Yang et al., 2002) or multiwavelength short pulses (Peng et al., 2003; Fok et al., 2007) have been proposed and experimentally analyzed. Mode-spacing and wavelength tuning laser using bismuth-oxide fiber or photonics crystal fiber with nonlinear effect have been studied and reported (Liu et al., 2008; Chen et al., 2007; Al-Mansoori et al., 2008). Comparing with our proposed dual-wavelength laser schemes as following (Yeh et al., 2008; Yeh et al., 2009), we only need commercially available and standard components to achieve the two-mode lasing and also has a benefit of cost-effective.

## 2. Dual-wavelength laser diode with fixed mode-spacing lasing

Here, first of all, we will introduce the dual-wavelength tuning semiconductor laser scheme via optical injection technology with fixed mode-spacing ( $\Delta\lambda$ ) output. Thus, in this

experiment, Fig. 1 shows the proposed structure of tunable dual-wavelength EDF ring laser (Yeh et al., 2008). The proposed fiber laser is consisted of an erbium-doped fiber amplifier (EDFA), a 2×2 and 50:50 optical coupler (OCP), a FP-LD and a polarization controller (PC). In Fig. 1, the EDFA constructed by an 10 m long EDF (Fibercore DC1500F), a 980/1550 nm WDM coupler, an optical isolator (OIS) and a 980 nm pumping laser. In this proposed laser scheme, when the pumping power exceeds 100 mW, it would saturate the lasing output. Thus, the 980 nm pump LD is set at 100 mW. The 3 dB bandwidth and average insertion loss of TBF used are nearly 0.4 nm and 3.5 dB respectively. The TBF also has a 40 nm tuning range from 1520 to 1560 nm.

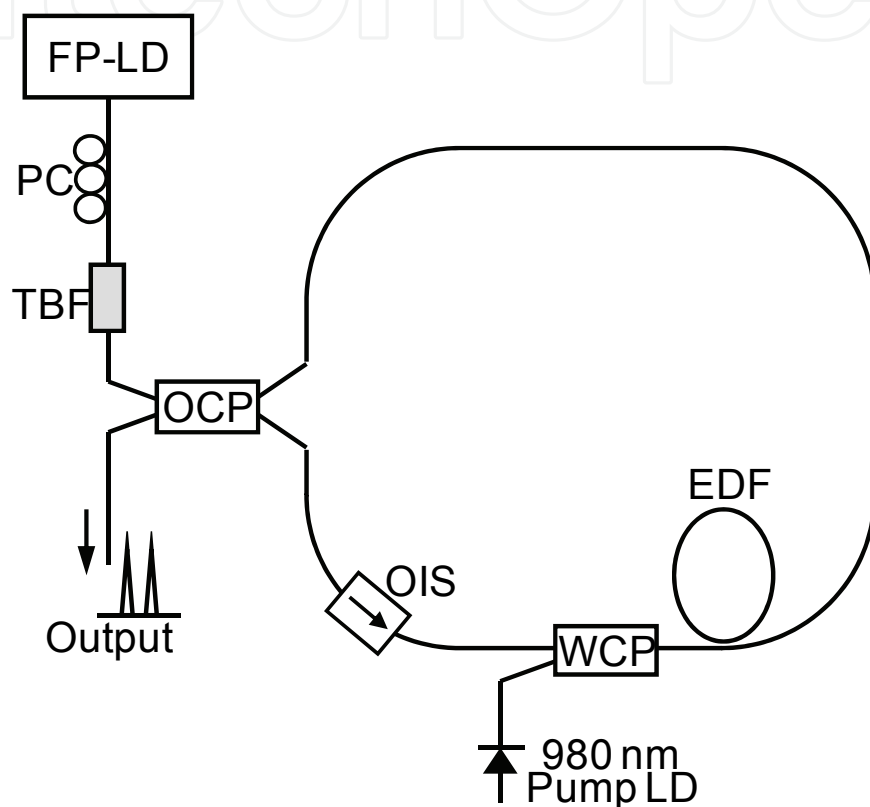

Fig. 1. Experimental setup of the proposed tunable and stable dual-wavelength fiber laser.

The PC between FP-LD and OCP is used to control the polarization state of the feedback injection light into the FP-LD. According to the past self-injected report (Liu et al., 2004), only one polarized direction being parallel to the TE-mode of FP-LD of feedback wavelength leads to the maximum self-injected efficiency. In the experiment, the mode spacing ( $\Delta\lambda$ ) and threshold current of FP-LD are 1.3 nm and 10 mA, respectively. In the measurement, the threshold pumping power in this experiment is around 20 mW while the FP-LD is operated at 18 mA and 25 °C. Therefore, we set the bias current of the FP-LD at 18 mA at the temperature of 25 °C. To measure and analyze the output power and wavelength of the proposed dual-wavelength laser, an optical spectrum analyzer (OSA) with a 0.05 nm resolution is used for the measurement. Fig. 2 presents the output wavelength spectrum of the FP-LD without self-seeding operation in the wavelength range of 1520 to 1570 nm. Fig. 2 also shows that the output power level of FP-LD is above -20 dBm around the wavelengths between 1545.0 and 1550.0 nm.

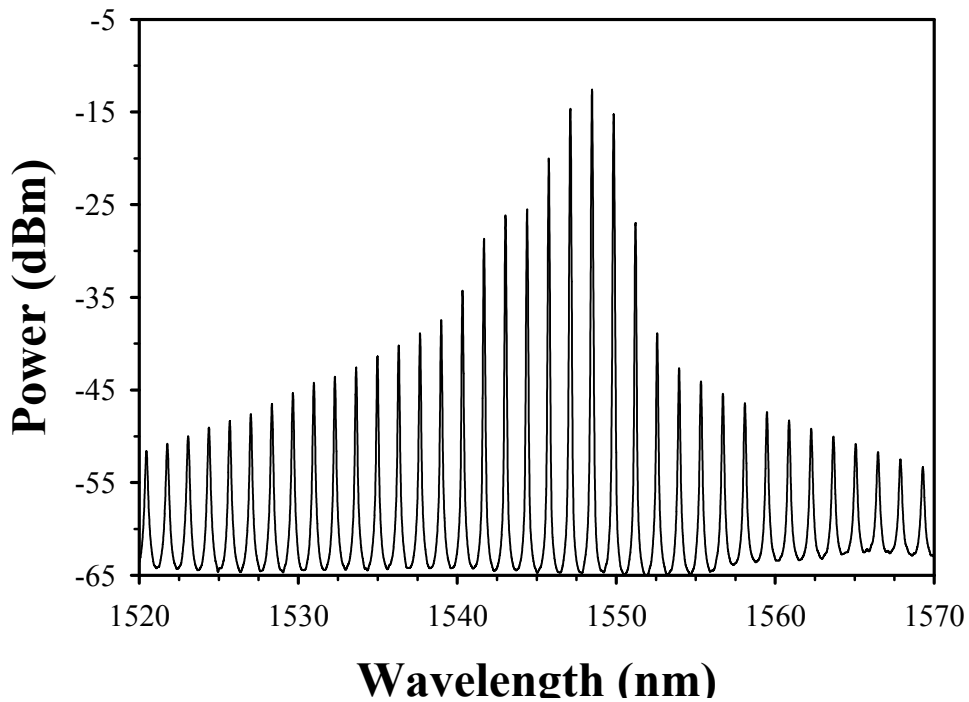

Fig. 2. Output wavelength spectrum of the FP-LD without self-seeding operation in the wavelengths of 1520 to 1570 nm when the LD operates at 18 mA and 25 °C.

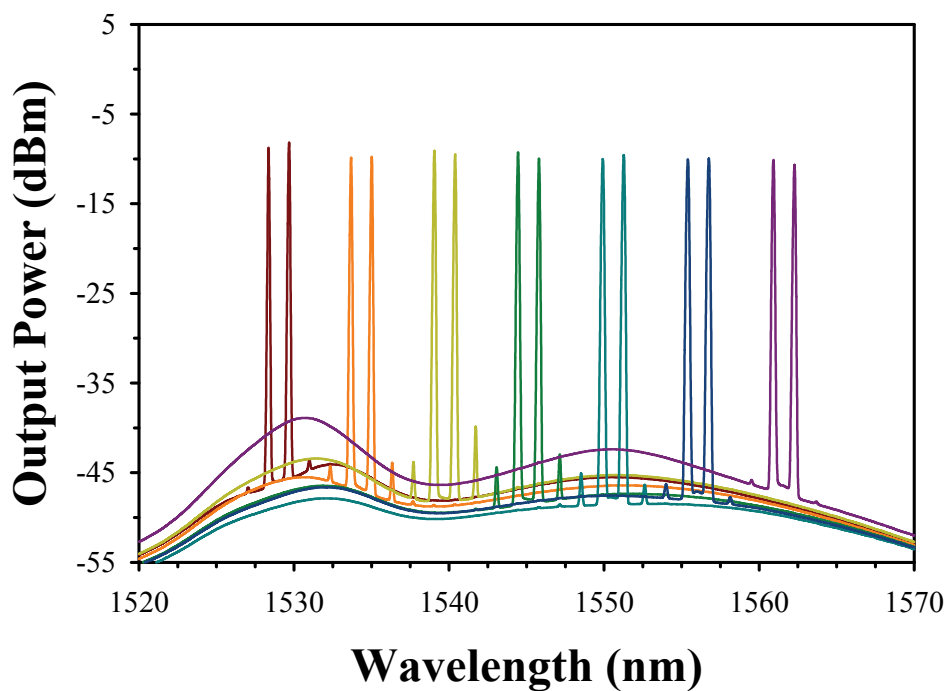

Fig. 3. Output wavelength spectra of the proposed dual-wavelength fiber laser with 100 mW pumping power and 18 mA bias current, in the operating wavelengths of 1523.08 to 1562.26 nm.

Then, by using the proposed self-injected structure, Fig. 3 displays the output wavelength spectra of the proposed dual-wavelength fiber laser when the 980 nm pump LD power and bias current of the FP-LD are 60 mW and 18 mA, respectively, in the operating wavelengths of 1523.08 to 1562.26 nm with 1.3 nm tuning step. In Fig. 3, the mode spacing of the dual-wavelength laser is measured at nearly 1.3 nm. The minimum side-mode suppression ratio (SMSR) is larger than 36.5 dB over the operating range. The maximum and minimum output powers of  $-9$  and  $-14.5$  dBm are also observed in the tuning range. Besides, the dual-wavelength can be slightly tuned by adjusting the temperature of the FP-LD. While the temperature difference ( $\Delta T$ ) of the FP-LD is  $\pm 5$  °C, the central wavelength variation also shifts at  $\pm 0.2$  nm. Therefore, the dual-wavelength can be tuned continuously by controlling the temperature. Based on the proposed laser architecture, the fiber laser not only can lase dual-wavelength but also enhance the tuning wavelength range to 39.18 nm. As a result, Fig. 2 is a free-run FP-LD, with very small output powers at shorter wavelength ( $< 1545.0$  nm) and longer wavelength ( $> 1555$  nm). However, in our proposed scheme, we simultaneously achieve two-mode laser with even and high output power across the wavelength range of 39.18 nm. The significantly improvement can be seen in Fig. 3. We have tried several coupling ratios (such as 90/10, 80/20, 70/30, 60/40 and 50/50) and we found that the 50/50 is the optimum case.

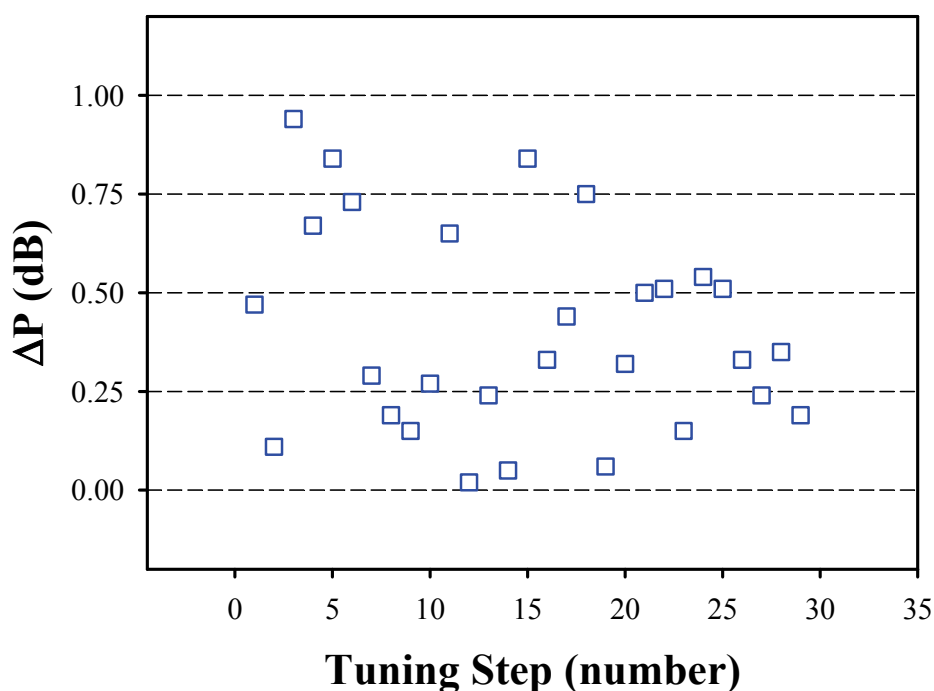

Fig. 4. Power difference ( $\Delta P$ ) of the lasing dual-wavelength in the operating range with  $\sim 1.3$  nm tuning step.

Figure 4 shows the output power difference ( $\Delta P$ ) of the lasing dual-wavelength in the operating range with  $\sim 1.3$  nm tuning step. The output power difference is defined to  $\Delta P = |P_1 - P_2|$ . The maximum and minimum  $\Delta P$  of 0.9 and 0.1 dB are measured in Fig. 4. As a result, the dual-wavelength also presents a good equalizing output power over the tuning range.

Fig. 5 shows the average output power and SMSR of the lasing dual-wavelength with 1.3 nm tuning step in the wavelengths of 1523.08 to 1562.26 nm. In the tuning step 7 to 28 (from

1530.88 to 1558.18 nm), the average output power and SMSR could be larger than  $-10$  dBm and 40.1 dB, respectively. For the whole tuning range, in the wavelengths of 1523.08 to 1562.26 nm (step 1 to 29), the minimum average output power and SMSR of  $-14.6$  dBm and 36.4 dB can still be achieved. Fig. 5 also shows a flat average output power in the tuning range in the tuning step 4 to 27 ( $\Delta P_{\max} = 0.9$  dB). Moreover, the average SMSR spectrum in Fig. 5 presents two peaks at the step 15 and 26, respectively. And the maximum difference of average SMSR is  $\sim 5.4$  dB in the tuning range.

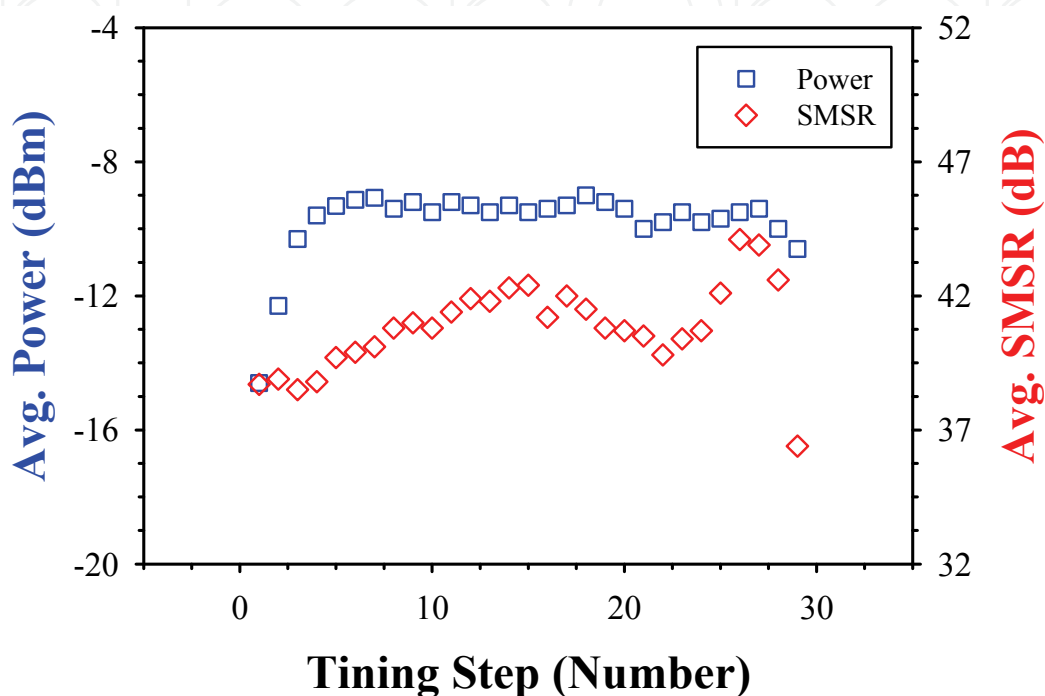

Fig. 5. The average output power and SMSR of the lasing dual-wavelength with 1.3 nm tuning step in the wavelengths of 1523.08 to 1562.26 nm.

In order to investigate the output stabilities of the proposed dual-wavelength laser, a short-term stability of output power and wavelength is measured and observed. In the measurement, the lasing two wavelengths are 1528.36 and 1529.67 nm with output power of  $-9.0$  and  $-8.4$  dBm initially over 20 minutes observation time. The output wavelength variations of the two wavelengths are zero and the maximum power fluctuation of  $-1$  and  $-2$  are 0.5 and 0.4 dB, respectively, as shown in Fig. 6. Then, in one hour observing time, the output stability is also maintained as mentioned before.

In summary, we have proposed and investigated a stable and tunable dual-wavelength erbium-doped fiber ring laser employing a self-injected FP-LD. By adding an FP-LD incorporated with a tunable bandpass filter within a gain cavity, the fiber laser can lase two wavelengths simultaneously due to the self-injected operation. The proposed dual-wavelength laser shows a good performance of output power and optical side-mode suppression ratio. The laser also presents a 39.18 nm wide tuning range from 1523.08 to 1562.26 nm. As a result, our proposed dual-wavelength fiber laser not only has the better optical output efficiency, but also has a wide tuning range of 39.18 nm. Besides, it has the advantage of simply architecture, low cost and better output efficiency.

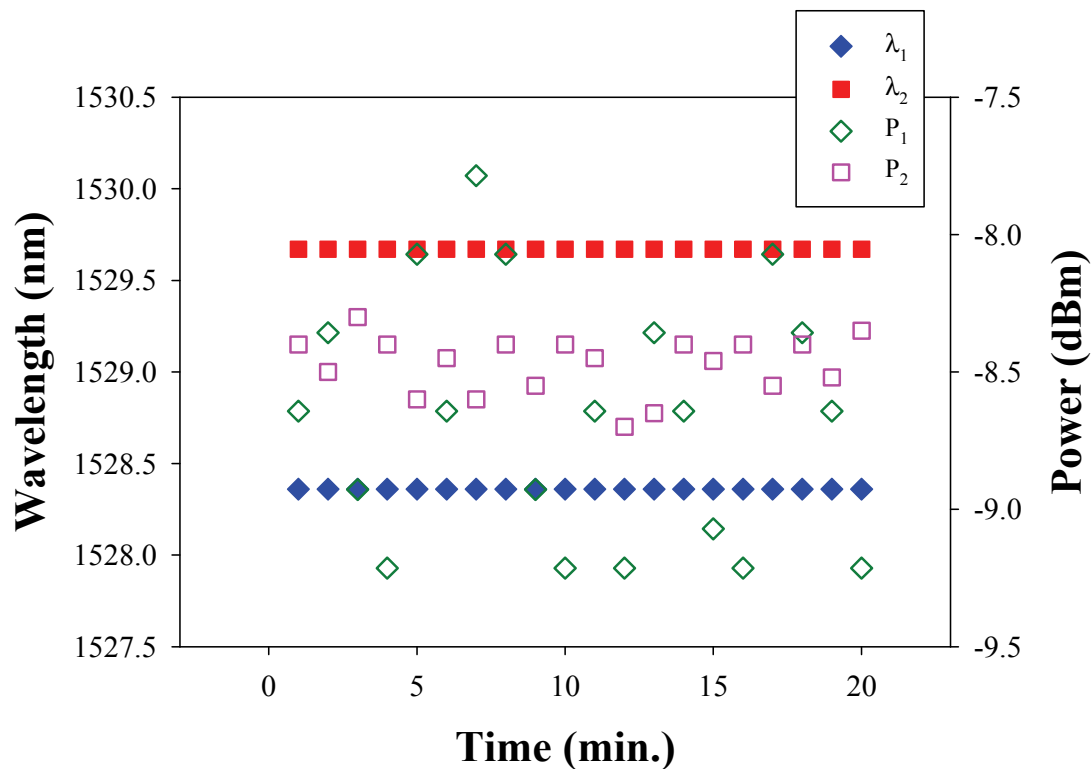

Fig. 6. The average output power and SMSR of the lasing two wavelengths with 1.3 nm tuning step from 1523.08 to 1562.26 nm.

### 3. Dual-wavelength laser diode with adaptive mode-spacing tuning

Then, to achieve a dual-wavelength lasing together with adaptive mode-spacing tuning, we can design a new optical-injection erbium-doped fiber (EDF) ring laser structure and use two tunable bandpass filters (TBFs) inside gain cavity loop for dynamically dual-wavelength selection. Here, the proposed laser has the following advantages: (i) two wavelengths can be tuned separately using the two tunable bandpass filters (TBFs); (ii) the mode spacing can also be tuned by the TBFs; (iii) the laser has a broadly tuning range; and (iv) the laser structure is relatively simple.

Fig. 7 shows the experimental setup for the tunable dual-wavelength fiber ring laser (Yeh et al., 2009). The proposed fiber laser consisted of one 2×2 3-dB coupler (CP), two 1×2 3-dB CPs, two TBFs, two polarization controllers (PCs), a FP-LD, and an erbium-doped fiber amplifier (EDFA). The EDFA was constructed by a 980/1550nm WDM coupler (WCP), 980 nm pump laser diode (LD), an optical isolator (OIS) and a 10 m EDF.

When the pumping power exceeds 100 mW in the proposed laser, the output power will be saturated. Thus, the 980 nm pump LD was set at 100 mW in the experiment. The 3 dB bandwidth and insertion loss of the TBF used was 0.4 nm and 4 dB respectively. The tuning range of the TBF was 40 nm (1520 to 1560 nm). The PCs were used to adjust the polarization states of the feedback lightwave into the FP-LD. According to the past study (Schell et al., 1995), injected optical signal at TE-mode of FP-LD can result in maximum injection locking efficiency.

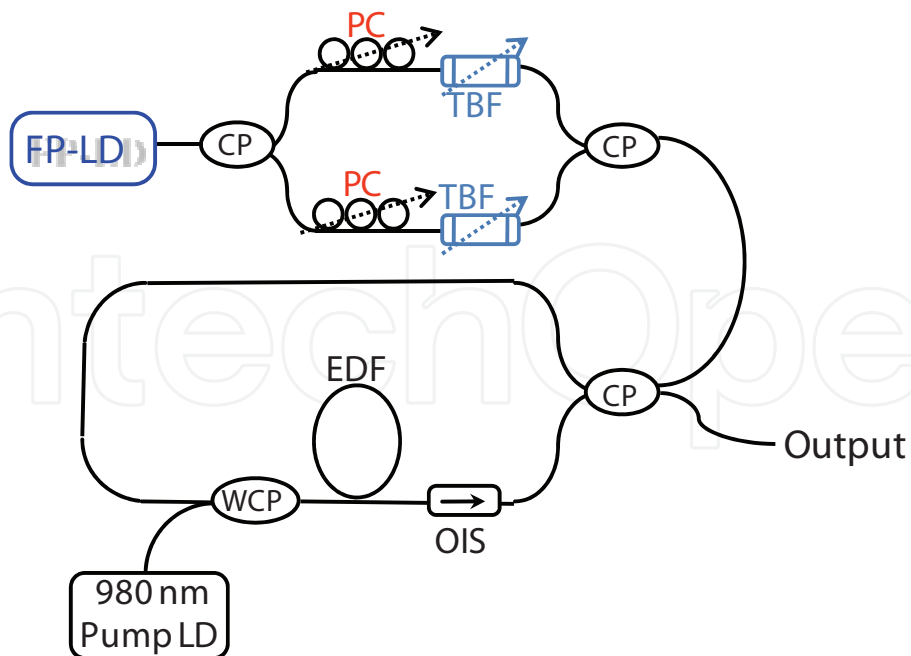

Fig. 7. Experimental setup for the tunable dual-wavelength fiber ring laser scheme.

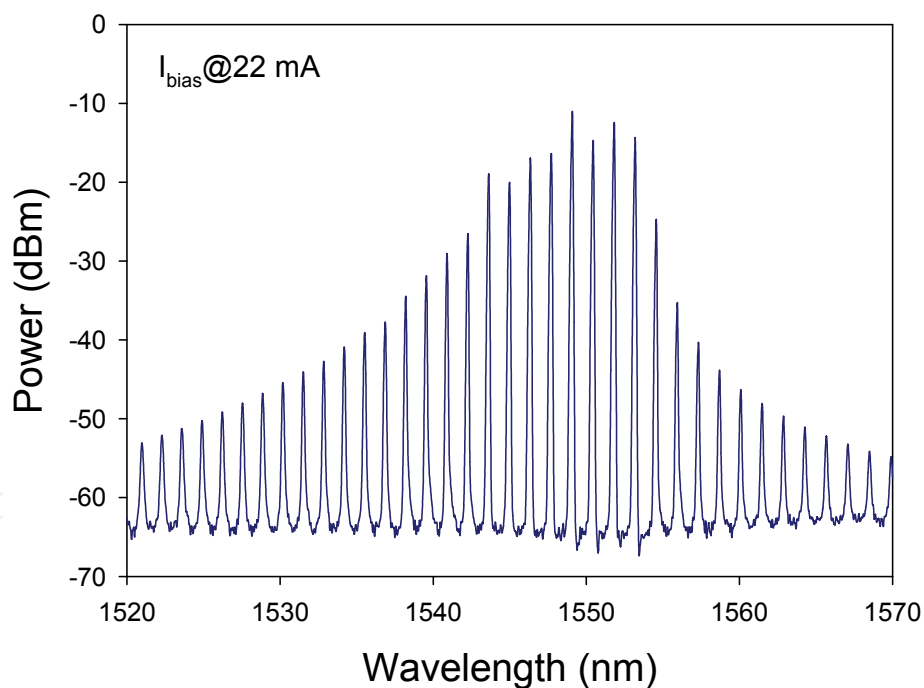

Fig. 8. Original output spectrum of FP-LD operates at 22 mA on 25 °C without self-seeding.

The threshold pumping power in this experiment was around 14 mW while the FP-LD was operated at 22 mA and 25 °C. To measure the output power and wavelength of the proposed dual-wavelength laser, an optical spectrum analyzer (OSA) with a 0.05 nm resolution was used in the measurement. Fig. 8 shows the original output spectrum of the free-run FP-LD without self-injection. The mode spacing ( $\Delta\lambda$ ) and threshold current of FP-LD are 1.38 nm and 9.5 mA, respectively.



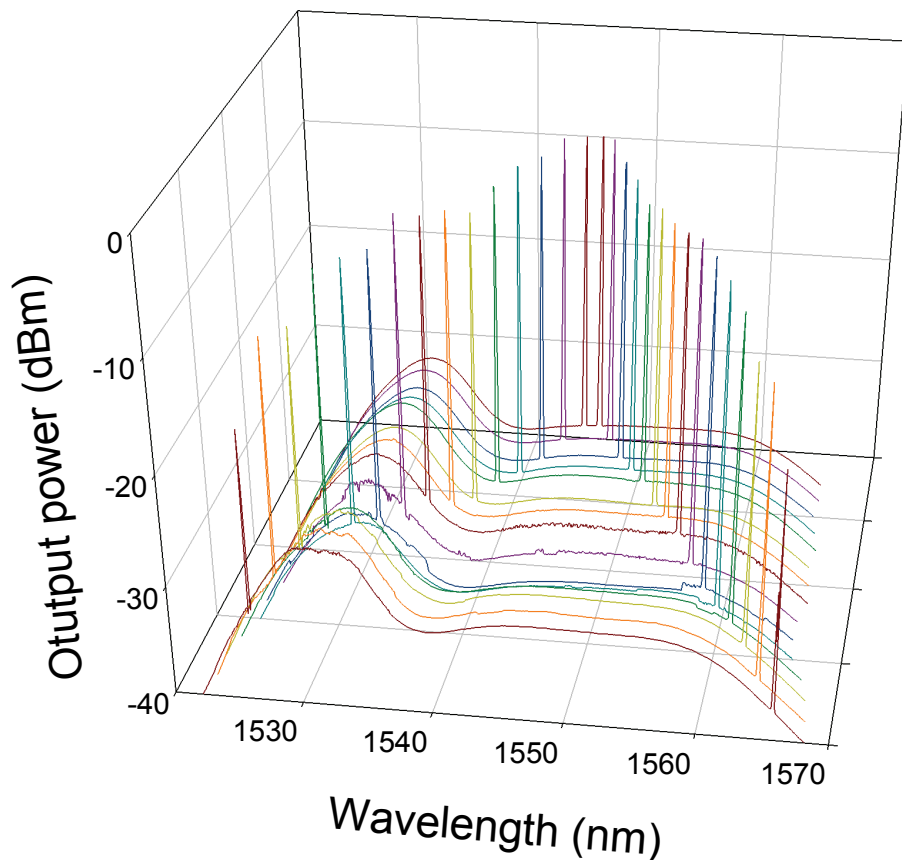

Fig. 9. Output wavelength spectra of the proposed tunable dual-wavelength fiber laser while the pumping power of 980 nm LD and bias current of the FP-LD are 110 mW and 22 mA, respectively, in the wavelength range of 1526.3 to 1565.8 nm with different mode spacing.

The two TBFs inside the ring cavity were used to align and filter the corresponding modes for two wavelengths lasing simultaneously. Fig. 9 shows the output spectra (wavelength range from 1526.27 to 1565.76 nm with different mode spacing) of the proposed tunable dual-wavelength fiber laser at the pumping power = 100 mW and bias current of the FP-LD = 22 mA. The mode spacing can also be determined by adjusting the two TBFs to properly align and match the filtering mode of the FL-LD. In Fig. 9, the maximum and minimum mode spacing of the dual-wavelength laser was 39.49 nm and 1.32 nm, respectively. Over the tuning range, the maximum and minimum power variation ( $\Delta P_{\max}$  and  $\Delta P_{\min}$ ) was equal to 0.98 and 0.01 dB when the mode spacing is 36.69 and 17.65 nm, respectively. The proposed laser is limited to step tuning (in this case, it is 1.32 nm). We can also retrieve the continuous wavelength tuning by adjusting the temperature of the FP-LD. While the temperature difference ( $\Delta T$ ) of the FP-LD was  $\pm 5$  °C, the central wavelength variation was  $\pm 0.2$  nm. Thus, the dual-wavelength can be tuned continuously by controlling the temperature.

Fig. 10 shows the output power differences and the average output powers under various mode spacing of the fiber laser. The average output power is between  $-13.56$  and  $-4.33$  dBm, as shown in Fig. 10. By increasing of the mode spacing gradually, the average output power is decreasing, as illustrated in Fig. 10. Thus, when the mode spacing is 39.49 nm, the output power will drop to  $-13.56$  dBm due to the smaller gain in both shorter and longer

wavelength sides of the FP-LD (in Fig. 8). Besides, the output power differences of the dual-wavelength can be less than 1 dB due to the proper adjusting of the PCs. The nonlinear filter function of the self-injected FP-LD can also improve the noise performance of the proposed laser (Zhao et al., 2002). We also studied the stability of the proposed laser, and the power variation during a 30 minutes observation time was negligible. We believe that the inhomogeneously broadened FP-LD gain saturation plays a part in suppressing the erbium gain competition. The stability of the proposed laser can be further enhanced by using all polarization maintaining (PM) components inside the laser cavity.

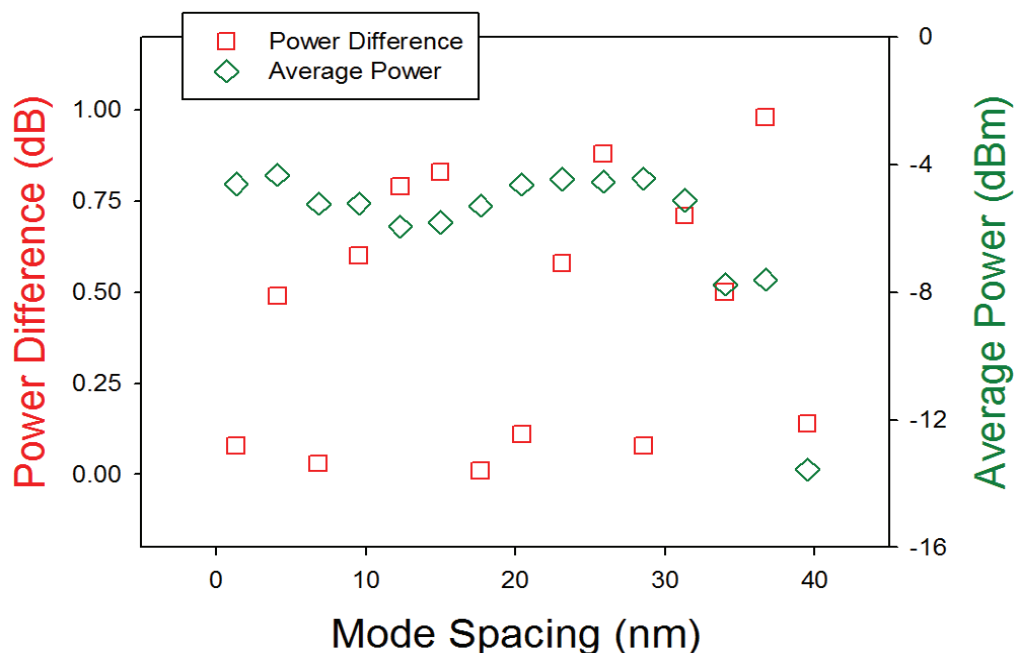

Fig. 10. Output power difference and average output power under various mode spacing for the tunable dual-wavelength fiber laser.

Fig. 11 shows the optical spectra of the dual-wavelength fiber laser lasing at wavelengths of 1545.08 and 1546.40 nm, when the pumping power was adjusted from 14 to 120 mW. The lasing output power will start to saturate at 100 mW, as shown in Fig. 11. The threshold pumping power of the proposed dual-wavelength laser was 28 mW, as also illustrated in Fig. 11.

In summary, we proposed and experimentally demonstrated a tunable dual-wavelength fiber laser based on a self-injected FP-LD and an EDF. The dual-wavelength output of the proposed fiber laser is widely tunable, and the mode spacing of the two lasing wavelengths can also be adjusted within the tuning range. Two TBFs were used inside the laser cavity to generate the dual-wavelength output. The dual-wavelength tuning range can be achieved up to 39.49 nm from 1526.27 to 1565.76 nm. The mode spacing of the dual-wavelength can be tuned by using the two TBFs to align the corresponding longitudinal-mode of the FP-LD. The maximum and minimum mode spacing of the laser is 39.49 and 1.32 nm, respectively. The proposed laser is limited to step tuning (in this case, it is 1.32 nm). Moreover, the threshold pumping power and saturated pumping power of the laser are 28 and 100 mW, respectively. The output power difference of dual-wavelength can be controlled to smaller than 1 dB.

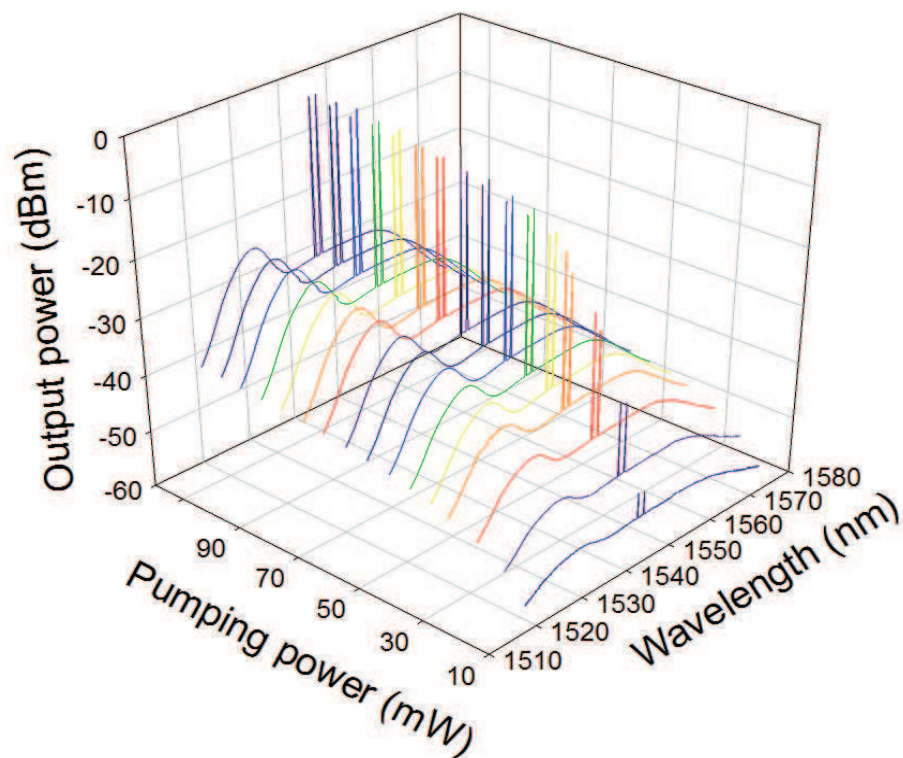

Fig. 11. Output wavelength spectra versus the different pumping power under 14 to 120 mW at the two wavelengths of 1545.08 and 46.40 nm initially.

#### 4. Conclusion

For the first proposed laser scheme, we have proposed and investigated a stable and tunable dual-wavelength erbium-doped fiber ring laser employing a self-injected FP-LD. By adding an FP-LD incorporated with a tunable bandpass filter within a gain cavity, the fiber laser can lase two wavelengths simultaneously due to the self-injected operation. The proposed dual-wavelength laser shows a good performance of output power and optical side-mode suppression ratio. The laser also presents a 39.18 nm wide tuning range from 1523.08 to 1562.26 nm. When compared with the previously proposed schemes, our proposed dual-wavelength fiber laser not only has the better optical output efficiency, but also has a wide tuning range of 39.18 nm. Besides, it has the advantage of simply architecture, low cost and better output efficiency.

For the second proposed laser structure, we have proposed and experimentally demonstrated a tunable dual-wavelength fiber laser based on a self-injected FP-LD and an EDF. The dual-wavelength output of the proposed fiber laser is widely tunable, and the mode spacing of the two lasing wavelengths can also be adjusted within the tuning range. Two TBFs were used inside the laser cavity to generate the dual-wavelength output. The dual-wavelength tuning range can be achieved up to 39.49 nm from 1526.27 to 1565.76 nm. The mode spacing of the dual-wavelength can be tuned by using the two TBFs to align the corresponding longitudinal-mode of the FP-LD. The maximum and minimum mode spacing

of the laser is 39.49 and 1.32 nm, respectively. The proposed laser is limited to step tuning (in this case, it is 1.32 nm). Moreover, the threshold pumping power and saturated pumping power of the laser are 28 and 100 mW, respectively. The output power difference of dual-wavelength can be controlled to smaller than 1 dB. As a result, the proposed two dual-wavelength fiber laser configurations not only are simple, but also are easy to setup for the future applications of WDM communications and optical sensor.

## 5. References

- Al-Mansoori, M. H., Mahdi, M. A., and Zamzuri, A. K. (2008): Tunable multiwavelength Brillouin-Erbium fiber laser with intra-cavity pre-amplified Brillouin pump. *Laser Phys. Lett.* 5, 139-143.
- Alvarez-Chavez, J. A., Martinez-Rios, A., Torres-Gomez, I., and Offerhaus, H. L. (2007) : Wide wavelength-tuning of a double-clad Yb<sup>3+</sup>-doped fiber laser based on a fiber Bragg grating array. *Laser Phys. Lett.* 4, 880-883.
- Barmenkov, Y. O., Kir'yanov, A. V., Perez-Millan, P., Cruz, J. L., and Andres, M. V. (2008): Experimental study of a symmetrically-pumped distributed feed-back Erbium-doped fiber laser with a tunable phase shift. *Laser Phys. Lett.* 5, 357-360.
- Chen D., and Shen, L. (2007): Switchable and tunable Erbium-doped fiber ring laser incorporating a birefringent and highly nonlinear photonic crystal fiber. *Laser Phys. Lett.* 4, 368-370.
- Chen, D., Ou, H., Fu, H., Qin, S., and Gao, S. (2007): Wavelength-spacing tunable multi-wavelength erbium doped fiber laser incorporating a semiconductor optical amplifier. *Laser Phys. Lett.* 4, 287-290.
- Chou, S.-Y., Yeh, C.-H., and Chi, S. (2007): Unitizations of double-ring structure and Erbium-doped waveguide amplifier for stable and tunable fiber laser. *Laser Phys. Lett.* 4, 382-384.
- Das, G., and Lit, J. W. Y. (2002): L-band multiwavelength fiber laser using an elliptical fiber. *IEEE Photon. Technol. Lett.* 14, 606-608.
- Fok, M. P., and Shu, C. (2007): Tunable dual-wavelength erbium-doped fiber laser stabilized by four-wave mixing in a 35-cm highly nonlinear bismuth-oxide fiber. *Opt. Express* 15, 5925-5930.
- Kim, Y. J., and Kim, D. Y. (2005): Electrically Tunable dual-wavelength switching in a mutually injection-locked erbium-doped fiber ring laser and distributed-feedback laser diode. *IEEE Photon. Technol. Lett.* 17, 762-764.
- Li, S., Chan, K. T., Liu, Y., Zhang, L., and Bennion, I. (1998): Multiwavelength picosecond pulses generated from a self-seeded Fabry-Perot laser diode with a fiber external cavity using fiber Bragg gratings. *IEEE Photon. Technol. Lett.* 10, 1712-1714.
- Liu, Y. G., Feng, X., and Yuan, S. (2004): Simultaneous four-wavelength lasing oscillations in an erbium-doped fiber laser with two high birefringence fiber Bragg gratings. *Opt. Express* 12, 2056-2061.
- Liu, Z. Y., Liu, Y. G., Du, J. B., Kai, G. Y., and Dong, X. Y. (2008): Tunable multiwavelength erbium-doped fiber laser with a polarization-maintaining photonic crystal fiber Sagnac loop filter. *Laser Phys. Lett.* 5, 446-448.
- Nilsson, J., Lee, Y. W., and Kim, S. J. (1996): Robust dual-wavelength ring-laser based on two spectrally different erbium-doped Fiber amplifiers. *IEEE Photon. Technol. Lett.* 8, 1630-1632.

- Peng, P.-C., Tseng, H.-Y., and Chi, S. (2003): A tunable dual-wavelength erbium-doped fiber ring laser using a self-seed Fabry-Perot laser diode. *IEEE Photon. Technol. Lett.* 15, 661–663.
- Schell, M., Huhse, D., Utz, W., Kaessner, J., Bimberg, D., and Taraov, I. S. (1995): Jitter and dynamics of self-seeded Fabry-Perot laser diodes. *IEEE J. Select. Topics Quantum Electron.* 1, 528–534.
- Slavik, R., and LaRochelle, S. (2002) : Multiwavelength single-mode erbium doped fiber laser for FFH-OCDMA testing. *Proc. of OFC*, Paper WJ3.
- Talaverano, L., Abad, S., Jarabo, S., and Lopez-Amo, M. (2001) : Multiwavelength fiber laser sources with Bragg-grating sensor multiplexing capability. *J. Lightwave Technol.* 19, 553–558.
- Yang, S., Li, Z., Yuan, S., Dong, X., Kai, G., and Zhao, Q. (2002): Tunable dual-wavelength actively mode-locked fiber laser with an F-P semiconductor modulator. *IEEE Photon. Technol. Lett.* 14, 1494–1496.
- Yeh, C. H., Chow, C. W., Shih, F. Y., Wang, C. H., Wu, Y. F., and Chi, S. (2009): Tunable dual-wavelength fiber laser using optical-injection Fabry-Perot laser. *IEEE Photon. Technol. Lett.* 21, 125-127.
- Yeh, C. H., Shih, F. Y., Wang, C. H., Chow, C. W., and Chi, S. (2008): Tunable and stable single-longitudinal-mode dual-wavelength erbium fiber laser with 1.3 nm mode spacing output. *Laser Phys. Lett.* 5, 821-824.

IntechOpen

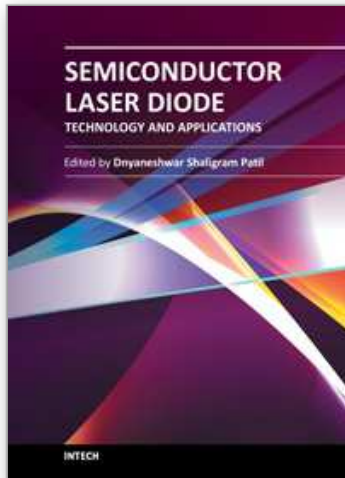

## **Semiconductor Laser Diode Technology and Applications**

Edited by Dr. Dnyaneshwar Shaligram Patil

ISBN 978-953-51-0549-7

Hard cover, 376 pages

**Publisher** InTech

**Published online** 25, April, 2012

**Published in print edition** April, 2012

This book represents a unique collection of the latest developments in the rapidly developing world of semiconductor laser diode technology and applications. An international group of distinguished contributors have covered particular aspects and the book includes optimization of semiconductor laser diode parameters for fascinating applications. This collection of chapters will be of considerable interest to engineers, scientists, technologists and physicists working in research and development in the field of semiconductor laser diode, as well as to young researchers who are at the beginning of their career.

### **How to reference**

In order to correctly reference this scholarly work, feel free to copy and paste the following:

Chien-Hung Yeh (2012). Tunable Dual-Wavelength Laser Scheme by Optical-Injection Fabry-Perot Laser Diode, *Semiconductor Laser Diode Technology and Applications*, Dr. Dnyaneshwar Shaligram Patil (Ed.), ISBN: 978-953-51-0549-7, InTech, Available from: <http://www.intechopen.com/books/semiconductor-laser-diode-technology-and-applications/tunable-dual-wavelength-laser-scheme-by-optical-injection-fabry-perot-laser-diode>

**INTECH**  
open science | open minds

### **InTech Europe**

University Campus STeP Ri  
Slavka Krautzeka 83/A  
51000 Rijeka, Croatia  
Phone: +385 (51) 770 447  
Fax: +385 (51) 686 166  
[www.intechopen.com](http://www.intechopen.com)

### **InTech China**

Unit 405, Office Block, Hotel Equatorial Shanghai  
No.65, Yan An Road (West), Shanghai, 200040, China  
中国上海市延安西路65号上海国际贵都大饭店办公楼405单元  
Phone: +86-21-62489820  
Fax: +86-21-62489821

© 2012 The Author(s). Licensee IntechOpen. This is an open access article distributed under the terms of the [Creative Commons Attribution 3.0 License](#), which permits unrestricted use, distribution, and reproduction in any medium, provided the original work is properly cited.

IntechOpen

IntechOpen