

We are IntechOpen, the world's leading publisher of Open Access books Built by scientists, for scientists

4,800

Open access books available

122,000

International authors and editors

135M

Downloads

Our authors are among the

154

Countries delivered to

TOP 1%

most cited scientists

12.2%

Contributors from top 500 universities



WEB OF SCIENCE™

Selection of our books indexed in the Book Citation Index
in Web of Science™ Core Collection (BKCI)

Interested in publishing with us?
Contact book.department@intechopen.com

Numbers displayed above are based on latest data collected.

For more information visit www.intechopen.com



Synthesis and Stoichiometric Analysis of a Li-Ion Battery Cathode Material

Norlida Kamarulzaman¹ and Mohd Hilmi Jaafar²

¹Centre For Nanomaterials Research, Institute of Science,
Universiti Teknologi MARA, Shah Alam, Selangor,

²Centre For Foundation Study In Sciences, University of Malaya, Kuala Lumpur,
Malaysia

1. Introduction

Generally, stoichiometry deals with the quantitative relationship of reactants and products in a chemical reaction. Strictly speaking in areas of materials science, solid-state physics and chemistry, stoichiometric compounds are compounds that have simple ratios to each other, that is, A_xB_y , where A, B = chemical element and x, y = natural numbers. There is no limit to the number of elements in the molecule.

Scientists nowadays modify materials such that their ratios are no longer simple ratios to each other but fractions, for example, $Li_{0.1}Mg_{0.9}O$, $Li_{1.1}Mn_2O_4$, $LiMn_{1.7}Fe_{0.3}O_2$, $Al_{1.9}Cr_{0.1}O_3$, and countless others. Strictly speaking, these compounds are called non-stoichiometric compounds. There are various reasons for obtaining non-stoichiometric compounds. It is found that processes such as substitution or doping will change, modify or enhance a material's physical and chemical behaviour. Scientists will then have a way to design materials to suit their applications. This can be seen in the well known semi-conductor, Si, whereby doping it with elements of different oxidation states can produce either a p-type or n-type silicon. This technology is very important because nearly all electrical devices are silicon based.

The most common cathode materials used in commercial Li-ion batteries is $LiCoO_2$ (Amatucci et al. 1996; Antolin et al. 2004; Ding et al. 2005). This is because $LiCoO_2$ gives high energy density as well as good cycling behaviour. However, in terms of economy and availability of elements, Co is considered expensive, not so abundant (Tanaka et al. 2001) and also considered a toxic heavy metal (Shin et al. 2004). Therefore, modification of the material or a complete change of material is warranted in order to have a sustainable technology.

There are other reasons for modifying the stoichiometry of cathode materials. It is found that substitution and doping of cathode materials improve the materials' electrochemical behaviour in terms of specific capacity and energy density (Li et al. 2002; Park et al. 2001; Veluchamy et al. 2001). Secondly, it may stabilize the material and improve cycling performance (Fey et al. 2003). Thirdly, it may lower the cost of production by reducing the usage of certain expensive metals such as cobalt and utilizing less expensive metals such as

Mn or Fe. Last but not least, it may reduce toxicity of the materials and contribute towards a healthier and safer living environment.

2. Substitution and doping

The word doping has been widely used by scientists. It originates from the work done on semiconductors to modify their characteristics. The technique was first introduced in the U.S.A. by John Woodyard of Sperrygyroscope Company (U.S. Patent 1950) but work was also done by Morgan Teal and Morgan Sparks of Bell Labs (U.S. Patent 1953). There are two kinds of doping, that is, substitutional and interstitial doping. As an example, $\text{Li}_{1.1}\text{Mn}_2\text{O}_4$ is obtained by interstitial doping while $\text{Li}[\text{Mn}_{1.7}\text{Fe}_{0.3}]\text{O}_4$ is obtained by substitutional doping. Observe that the spinel stoichiometry of AB_2O_4 is conserved for the later material but not for the former material. Substitutional doping is therefore taken as the introduction of foreign elements into the host material to take the place of some proportion of the original host chemical or element. Substitutional doping, thus, preserves the crystal structure of the compound while interstitial doping may change or modify the structure. The important point is that, for substitutionally doped compounds, the positions of the atoms are precisely known in the crystal lattice whereas for an interstitially doped compound, the atoms/ions may sit in interstitials whereby the position is not precisely known. Thus, it is quite problematic to analyze stoichiometries of interstitially doped materials in terms of the position of the foreign elements in the crystal structure of the materials.

Obtaining pure, single phase substituted materials is not an easy task. The thermodynamic properties of the elements involved must be taken into account. As an example, if some of the Mn in LiMn_2O_4 is to be substituted with Fe, to produce say, $\text{LiMn}_{1.7}\text{Fe}_{0.3}\text{O}_4$, the reaction temperature must be carefully controlled because the enthalpies of the oxides of the metal/transition metals are generally lower than that of the LiMn_2O_4 material. The enthalpy of formation is given for the metal-transition metal oxides as follows:

$$\alpha\text{-Fe}_2\text{O}_3 \text{ at } 298.15 \text{ K} \quad \Delta_f H^\circ = -824.2 \text{ kJ/mol} \quad (\text{Lide } 1995)$$

$$\beta\text{-MnO}_2 \text{ at } 298.15 \text{ K} \quad \Delta_f H^\circ = -520.0 \text{ kJ/mol} \quad (\text{Lide } 1995)$$

$$\text{Mn}_2\text{O}_3 \text{ at } 298.15 \text{ K} \quad \Delta_f H^\circ = -959.0 \text{ kJ/mol} \quad (\text{Lide } 1995)$$

$$\text{LiMn}_2\text{O}_4 \text{ at } 876.0 \text{ K} \quad \Delta_f H^\circ = -1404.2 \text{ kJ/mol} \quad (\text{Yamaguchi et al. } 1995)$$

As can be seen, iron and manganese oxides are easier to form than LiMn_2O_4 or $\text{LiMn}_{1.7}\text{Fe}_{0.3}\text{O}_4$ materials and the probability of their formation is high. Therefore, careful analysis has to be done of a TG/DSC thermal profile of $\text{LiMn}_{1.7}\text{Fe}_{0.3}\text{O}_4$ precursors obtained for the identification of a suitable calcination temperature that will not result in the formation of the metal/transition metal oxide impurities in the calcined sample. Optimally, for this example, the temperature chosen should be high enough to produce pure $\text{LiMn}_{1.7}\text{Fe}_{0.3}\text{O}_4$ material, by-passing the lower temperatures of formation for the metal/transition metal oxides. Normally, for good electrochemical characteristics of the $\text{LiMn}_{1.7}\text{Fe}_{0.3}\text{O}_4$ material, the calcination temperature chosen is above 800°C and the precursor has to be placed in an already heated furnace of the right temperature.

Choosing the right calcination temperature will suppress the formation of the impurity metal oxides in the sample. The high temperature heating will force the Fe ions into the LiMn_2O_4 lattice and produce stoichiometric $\text{LiMn}_{1.7}\text{Fe}_{0.3}\text{O}_4$ material. A well chosen calcination temperature will produce pure, single phase $\text{LiMn}_{1.7}\text{Fe}_{0.3}\text{O}_4$ material with good electrochemical behaviour.

3. Synthesis routes

Cathode materials used in Li-ion batteries consist of quite complex stoichiometries, containing two or more cations and one or more anions. Examples of some common cathode materials are LiCoO_2 , $\text{LiCo}_{1-x}\text{Ni}_x\text{O}_2$, LiMn_2O_4 , $\text{LiMn}_{1-x}\text{Fe}_x\text{O}_4$ and LiFePO_4 . Many synthesis methods can be used in obtaining a particular chemical compound suitable for use as cathodes in Li-ion batteries. The choice of a synthesis method depends on the available starting materials, the apparatus accessible to the scientist and the desired characteristics of the final product. The common synthesis methods used are the solid-state reaction, the sol-gel, the combustion and the hydrothermal methods. There are many other methods available but only the first three will be discussed here.

The solid state reaction method involves starting materials which are normally powders. The materials are firstly mixed together to form a homogeneous mixture and normally a grinding process using a mortar and pestle is used. The mixed powder will be pressed into pellets where they will then undergo a precalcining process. Usually the precalcined temperature is at a lower temperature of around 500 to 650 °C (Ohzuku et al. 1999; Zou et al. 2005; Li et al. 2000; Wu et al. 2001). The precalcined pellets will be ground and pelletized again whence they will be reacted at a high temperature of between 700 to 1200 °C (Ohzuku et al. 1999; Zou et al. 2005; Li et al. 2000; Wu et al. 2001). The pellets will normally be reground again. The advantage of this method is ease and simplicity. The disadvantage is that it normally yields impure final products and large particle size that may not produce the best electrochemical performance.

The sol-gel or Pechini synthesis method is now very popular due to several reasons such as versatility in the method (especially for partial cation substitution synthesis), more homogeneous particle size (compared to the solid-state reaction method), ease in obtaining phase pure products, a lower calcining temperature in some instances and better electrical behaviour (Lu et al. 2001; Huang et al. 2000). The starting materials should be compounds that will easily dissolve in a solvent. Normally hydroxides, acetates or nitrates of the metals will be used. There may or may not be a chelating agent employed. Chelating agents are normally acids. The starting materials will be dissolved in the solvents by stirring for some time and the chelating agent will be added until a gel is formed. Then, a slow drying process is done until a precursor material is acquired. Usually, a thermal profile of the precursor is taken and analyzed in order to identify suitable calcining temperatures. The materials will be calcined using temperatures from 500 to 1200 °C

The combustion synthesis method has several advantages over the other two methods. It is a relatively cheap, easy and rapid way of obtaining the precursors. Normally, the precursor obtained is pure, of very fine particles and they are more homogeneous in terms of size and shape. The particle size is often sub-micron but this depends on the calcination temperatures and the time duration of the heating process. The synthesis method also involves the

dissolution of the metal starting materials in a solvent. An oxidant such as glycine, amines or acids is added and the mixture is then slowly heated. A combustion reaction will eventually occur which is over in a few seconds. The precursor material is obtained and later calcined. There are a few considerations to be made with this type of synthesis method. If the reaction is very vigorous, then calculations for 5 g or less of final product should be done and a proper synthesis environment must be considered. These are safety precautions that should be taken to avoid explosions.

4. Techniques for the analysis of material stoichiometries

Cathode materials usually have complex stoichiometries as mentioned in section 1.0 above. Therefore, substantiation of the stoichiometries of the synthesized products is necessary. Often, the stoichiometries of the synthesized materials may not be exactly as calculated from molar ratio considerations. This is because the steps involved in the synthesis methods may introduce errors. For example, the weighing of the starting materials themselves is a crucial step and if not done carefully can be a serious source of error. Calcination procedures may also produce errors in stoichiometries due to certain processes such as Li vapourization at high temperatures of 850 °C and above producing lithium deficient materials (Ohzuku et al. 1990). The resulting final product may therefore be slightly different from the calculated values. That is why it is important to experimentally determine the stoichiometries of the final products.

There are many ways to elucidate the stoichiometries of cathode materials. Methods such as energy dispersive X-Ray spectroscopy (EDS), X-Ray diffraction (XRD), neutron diffraction (ND), X-Ray photoelectron spectroscopy (XPS), X-Ray fluorescence (XRF), inductively coupled plasma (ICP) and time of flight secondary ion-mass spectrometry (tof-SIMS) are some examples of methods that can give a measure of the stoichiometries of materials. Some methods such as EDS, XRD and ND are non-destructive techniques but others such as ICP and tof-SIMS are destructive. This is often due to the sample preparation methods and not the measurement technique itself. An exception is tof-SIMS where the principle of the method itself is destructive of the samples. The methods to measure the stoichiometries of materials have varying accuracies and most have limitations as to the range of atomic number (Z) of the elements in the periodic table that can be detected. Only EDS, XRD, ND and XPS will be discussed here. One important factor that is emphasized is that the samples used must be phase pure except for the diffraction methods. This is because diffraction can qualify and quantify the presence of different phases while the other methods cannot. However, EDS has one advantage, that is, it has high spatial resolution especially in the TEM.

4.1 Energy dispersive X-ray spectroscopy via SEM and TEM

EDS is a relatively easy method of elucidating stoichiometries of materials (Echelin et al. 1992; Goldstein et al. 1995). However, several considerations have to be made before a measurement is done. EDS normally has to be used in conjunction with a SEM or TEM. The accelerating voltage of SEM and TEM is not the same whereby it may affect the accuracies of the EDS results obtained. TEM also has a much smaller probe current area than SEM and this affects some measurements involving very small dimensions or areas under consideration.

An EDS detector is not unlike an elemental analyzer. It is normally integrated with a SEM or TEM. Particular advantage here is that scientists can choose the spots or area on the sample of which to be analyzed. With modern EDS detectors, the accuracy of the measurements are acceptably high and another advantage of the technique is that it is appreciably easier than other elemental methods such as mass-spectroscopy. When energetic electrons in a SEM or TEM column hit an atom of a sample, it may eject an inner orbital electron. A hole is created and the atom becomes unstable. Characteristic X-Rays will be produced when electrons in the outer orbital jumps to the inner orbital to occupy the vacancy. These characteristic X-Rays are used to identify an element *via* an EDS detector (normally, Si(Li)). This is the basic principle of elemental detection in EDS. Fig. 1(a) below illustrates the process of the ejection of the inner orbital electron by an incident energetic electron (from a SEM/TEM electron gun) and Fig. 1(b) shows the filling in of the hole by an outer orbital electron and the production of characteristic electromagnetic waves accompanying the process.

There are considerations to be made in using EDS to deduce stoichiometries of materials. Firstly, the detection limit of EDS is from the atomic number $Z > 3$ or $Z > 11$ depending on the type and quality of the EDS detectors used. Therefore, light elements cannot be detected by EDS. Detection limits is typically about 0.1 weight per cent or more of elements in the sample (subject to the quality of the EDX detector). Detection energies range from 1 to 30 keV in a SEM and higher in a TEM due to the greater accelerating voltages possible in a TEM. Another limitation of the EDS technique is the overlapping of peaks of the characteristic X-Rays of the elements. For example, the peaks of Mn K_{α} , Ti K_{α} , and Cr K_{β} are very close together and overlaps. Care has to be taken when samples contain elements with very close K and L lines.

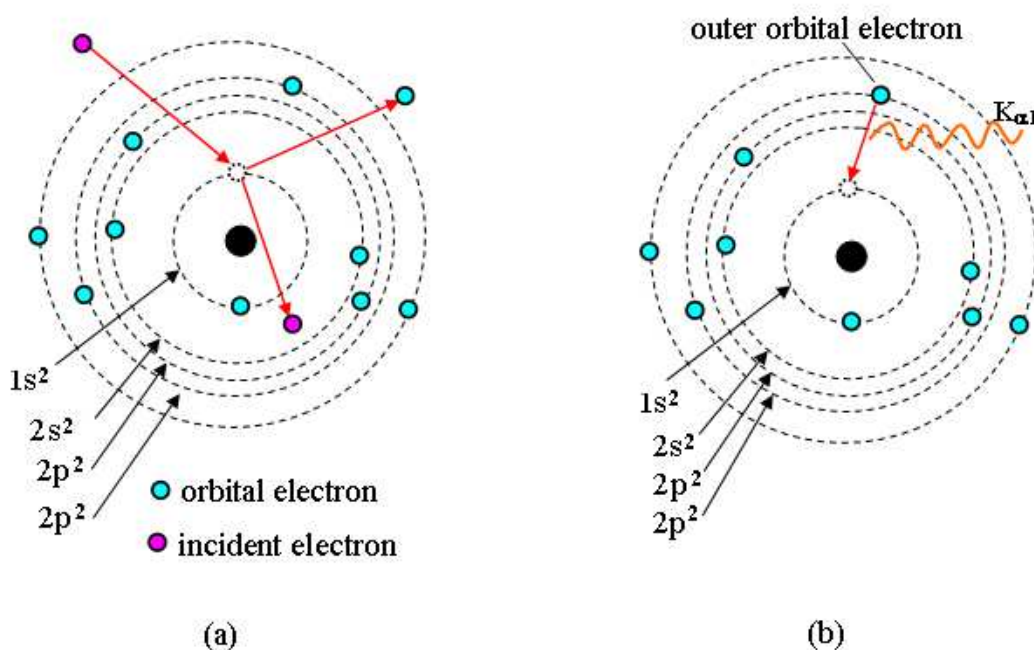

Fig. 1. The process of X-Ray production in EDX measurements of samples (a) showing how an inner orbital electron is ejected out from an electron coming from the electron gun of a SEM/TEM and (b) the production of characteristic X-Rays from the transition of an outer electron orbital to the inner orbital

The interactions of the incident electron beam with the sample can be broadly divided into two, that is, elastic and inelastic. In elastic collisions, both the momentum and kinetic energy is conserved. However, for inelastic collisions, momentum is conserved but not kinetic energy. The dominant scattering event in a SEM or TEM basically depends on the incident electron beam energy and the atomic number (Z) of the elements in the sample. If the dominant scattering event is elastic, the interaction volume will have a wider width whereas if it is inelastic, it will have depth and the electrons will lose energy as it penetrates deeper into the sample. Thus, the interaction volume in a sample is dependent on the electron beam energy and the Z of the elements in the sample. The interaction volume of EDS is generally about a few microns into the sample and the depth for K and L lines are not exactly the same (Joy 1995; Oxford EDS Manual). This is illustrated in Fig. 2. EDS is therefore, not considered a surface analysis technique and is more representative of the bulk. However, it is different in the EDX TEM if the measurement is done on a very small particle or very thin section.

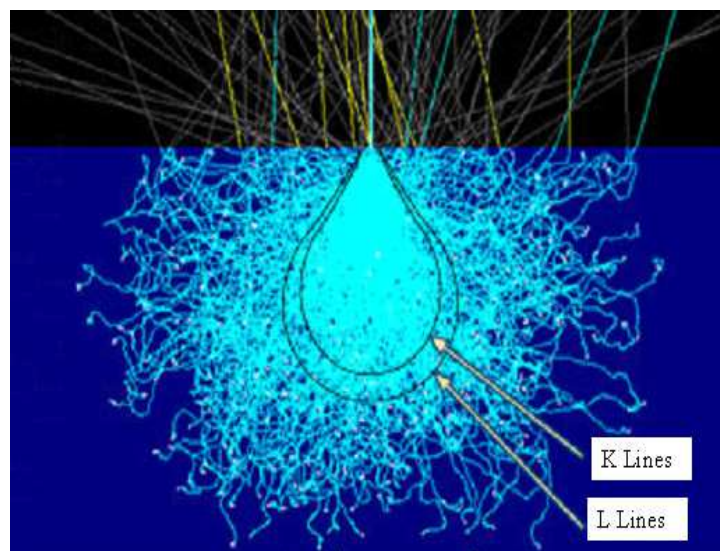

Fig. 2. The interaction of incident electrons with a sample (Oxford EDS Manual). The interaction volume for the K and L lines are not the same.

The EDS measurements shown in Fig. 3 are taken using optimized optical conditions such as distance of sample to electron beam pole piece, accelerating voltage, position of sample to EDS detector, detector settings, etc. as described in the respective manuals. The electron accelerating voltage for SEM is 15 kV while that for TEM is 200 kV. The EDS equipment models used in the measurements here is the Oxford INCA X-Max 51-XXM 0021 integrated with the SEM (JEOL JSM-7600F) and INCAx-sight 6498 integrated with the TEM (JEOL JEM-2100F). The EDS results obtained *via* SEM and TEM of the cathode material $\text{LiCo}_{0.3}\text{Ni}_{0.3}\text{Mn}_{0.3}\text{Cr}_{0.1}\text{O}_2$ shown in Fig. 3 (a) and (b) respectively clearly show the presence of the transition metals, Co, Ni, Mn and Cr. The results are summarized in Table 1 and the comparison is also made with the calculated synthesized values. It is observed that the EDS results from both SEM EDS and TEM EDS show transition metal content quite close to the calculated values. The deviation is about 1-4% for SEM EDS and 1.6-9% for TEM EDS respectively for Co, Ni and Mn. It is higher for Cr, that is, from 2.4% for SEM EDS and 22% for TEM EDS respectively. The higher deviations for SEM and TEM EDS may be due to

different sample conditions whereby, the amount of sample in the SEM is much more than the amount of sample in TEM. The thickness of samples in TEM is also much smaller than in SEM. Therefore, averaging is more accurate in the SEM EDS. The SEM EDS equipment model used here is also newer and has slightly higher resolution giving more accurate results. Although oxygen counts are not considered very accurate for reasons discussed above, they are evaluated here to gauge the accuracy of results (when they are taken into account). It is remarkable that the oxygen content from the EDS measurements are quite close to the calculated value as can be seen in Table 1. Of course values from the measurements show higher content than calculated values but this is expected because although the vacuum environment eliminates most of the oxygen in the sample environment, there are still a number of O₂ molecules present that contributes to the higher oxygen counts measured. There is also adsorbed oxygen on the surface of the particles which will increase the count. The determination of Li in the sample cannot be done as the electron energies involved is out of range of the detector. It is always a problem to study lithium in cathode materials for Li-ion batteries. Stoichiometric values of transition metals in cathode materials, however, can be determined quite accurately by using EDS.

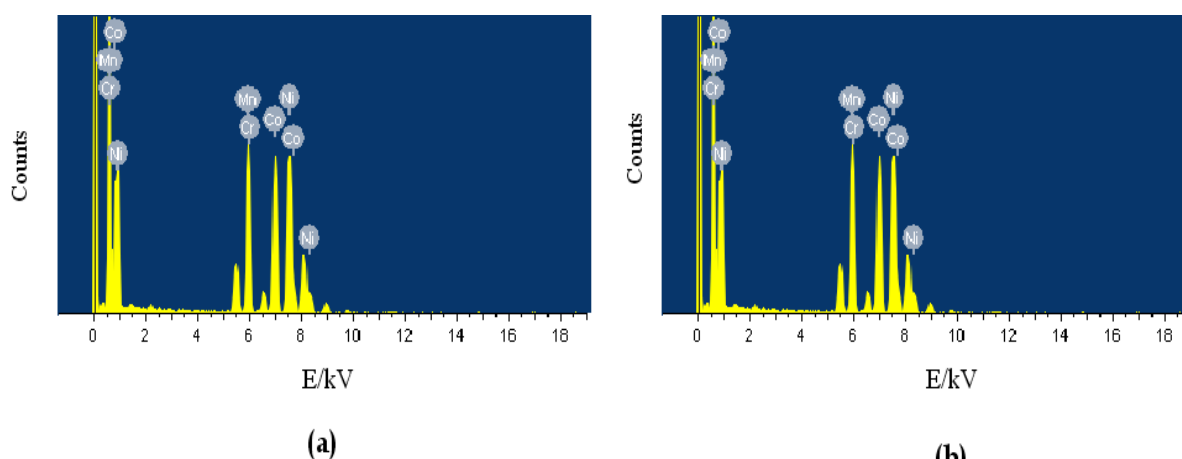

Fig. 3. EDS results obtained from (a) SEM EDS and (b) TEM EDS

Element	Calculated atomic per cent without O (%)	EDS SEM Atomic per cent without O (%)	EDS TEM Atomic per cent without O (%)	Calculated atomic per cent with O (%)	EDS SEM Atomic percent with O (%)	EDS TEM Atomic percent with O (%)
Cr	10.0	10.40	8.43	3.33	3.41	2.59
Mn	30.0	29.97	30.80	10.0	9.97	9.47
Co	30.0	30.30	31.25	10.0	10.13	9.60
Ni	30.0	29.33	29.25	10.0	9.25	9.07
O	-	-	-	66.67	67.24	69.27

Table 1. Comparisons between calculated synthesized values of LiCo_{0.3}Ni_{0.3}Mn_{0.3}Cr_{0.1}O₂ material and EDS results from SEM and TEM (O - oxygen). The atomic percentages are compared for EDS measurements with and without oxygen.

4.2 X-ray and neutron powder diffraction

The technique of X-Ray diffraction (XRD) or more precisely in this case, X-Ray powder diffraction (XRPD), is a very well established method used for material studies (Klug, et al. 1954; Kittel 2005). When X-Rays hit a crystalline target, the phenomenon of diffraction occur producing interference fringes as shown in Fig. 4 (a). This arises from a scattering process by which the X-Rays are scattered by the target material without change in wavelength (also called Bragg scattering). Diffraction occurs only when certain conditions are satisfied according to Bragg law or Laue equation (Klug, et al. 1954). The Bragg equation is given by,

$$2d \sin\theta = n\lambda \quad (1.0)$$

where d – interplanar spacing between successive atomic planes in the crystal

- θ – angle between the atomic plane and the reflected beam (also called Bragg angle)
- n – integer
- λ – wavelength of X-Rays

Equation (1.0) is actually the condition for constructive interference (Christman 1988). The incident beam of X-Rays used is normally $\text{Cu K}\alpha$. In the so-called θ - θ optical set-up, the incident X-Ray beam moves over the same angle as the detector, as shown in Fig 4 (b). In Fig 4 (a), S_1 and S_2 are slits and L is the position of the detector. The 2θ angle, which is the angular value given with corresponding peak intensities in the XRD pattern, is actually the angular value given with corresponding peak intensities in the XRD pattern, is actually the angle of deviation and can be seen in Fig. 4 (a) marked δ . The value of δ is 2θ .

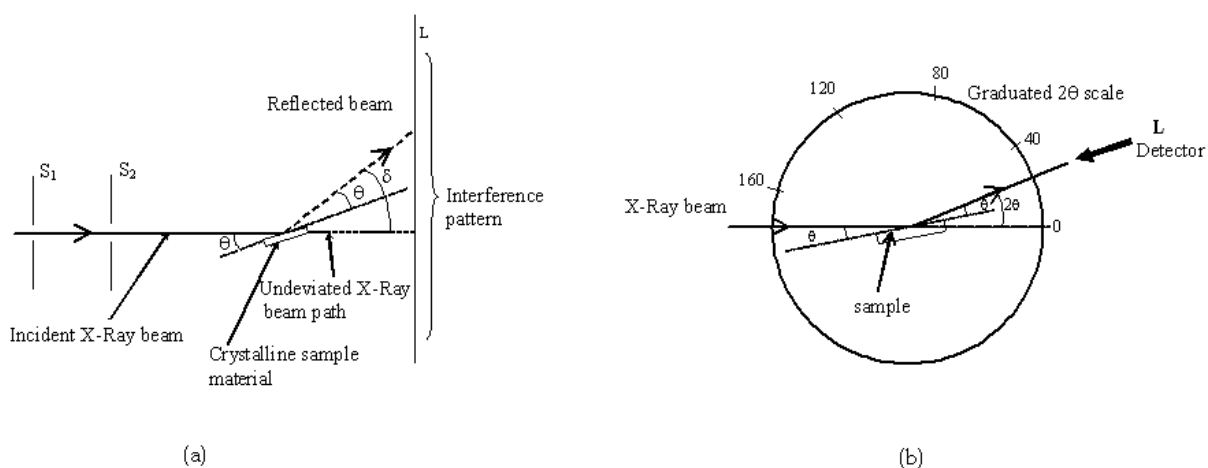

Fig. 4. X-Ray beam paths in an X-Ray diffractometer for (a) incident X-Rays on a crystalline sample undergoing diffraction and producing an interference pattern and (b) schematic of a θ - θ optical set-up. The X-Ray beam moves in conjunction with the detector.

In order to use XRD to elucidate stoichiometries of materials, quantitative analysis has to be done. There are several limitations and points to consider. First and foremost is that the diffractometer must be well aligned and calibrated. The optical settings should be suitable for good resolution and high counts. As a guide, the highest peak for the sample should be around 10,000 counts for good statistics and the 2θ angle should be as high as can be measured by the goniometer. The step size must be appropriately chosen to reflect suitable

number of data points in a peak. An accepted rule is that there should be 10-20 individual data points above the full width at half-maximum (fwhm) (Jenkins et al. 1996). The data can then be considered good and suitable for quantitative analysis. If the crystals in the sample show plate-like or rod-like shapes, then there are preferred orientation issues that have to be addressed. To minimize this effect, the sample preparation should be done by the back-loading method and the spinning mode used during measurement. In extreme cases, the sample has to be loaded in glass capillaries and the measurements should be done using a Debye-Scherrer optical geometry. The spinning mode is also used for this optical set-up. In most cases, data is acquired using the Bragg-Brentano geometry.

Neutron diffraction is a technique only available at large neutron research facilities such as in the HFIR (Oak Ridge National Lab, United States of America), J-Parc (Japan), ILL (France) and OPAL (Australia). Beam time allocation is not easily available and can only be obtained *via* a strictly reviewed proposal system. There are two types of neutron diffractions available, that is, the constant wavelength and the time of flight (tof) neutrons (David et al. 2002). Neutrons interact differently with matter compared to that of X-Rays. X-Rays interact with the electron cloud surrounding the nucleus of an atom but neutrons interact with the nucleus directly. Therefore, X-Ray scattering cross section is dependent on the atomic number (Z) of atoms whereas neutron scattering cross section is a more complex process described by the so called Fermi pseudopotential. However, one advantage of neutrons is that it can be scattered by light atoms relatively well and thus, is an advantage for materials containing elements such as lithium and hydrogen in the presence of heavier elements such as Cu, Co, Mn, etc. (Kamarulzaman et al. 2009).

Quantitative XRD and ND data analysis of the $\text{LiCo}_{0.3}\text{Ni}_{0.3}\text{Mn}_{0.3}\text{Cr}_{0.1}\text{O}_2$ material is done by the Rietveld refinement method. For the XRD in this work, the diffractometer used is the PanAlytical Xpert Pro MPD with the Bragg-Brentano optical configuration and a solid-state detector, called the Accelerator. The structure refinement software used is the Xpert Highscore Plus using a reference structure, ICSD 99891. Neutron data is acquired from the OPAL reactor facility, at the Australian Nuclear Science and Technology Organization (ANSTO) using constant wavelength neutrons. The optical set-up is the Debye-Scherrer configuration with position sensitive detectors. The data analysis was done using the GSAS (Larson et al. 2004) software with EXPGUI (Toby 2001). Stoichiometry of the cathode material can be obtained by performing a Rietveld refinement on the X-Ray and Neutron data. Although Rietveld refinement is used primarily to study the structure of materials, stoichiometric information can be elucidated by refining the site occupancy factor (s.o.f.) of the atoms in their crystallographic sites in the structure (Giacovazzo 2006). The stoichiometry of the materials can then be obtained. Another advantage of using ND is that, the Li content can be elucidated and quantitative values obtained. It is otherwise very difficult to check the Li stoichiometry experimentally. The refined XRD and ND data are shown in Fig. 5 and Fig. 6 respectively. Site occupancy factors of the metals and transition metals are shown in Table 2. It can be seen that the R_w and chi squared values imply high accuracy in the quantification obtained from the refinements. The values obtained from the two diffraction methods agree very well. It is possible to evaluate lithium stoichiometry from neutron data due to the strong interaction of neutrons with light elements and this is an added bonus derivable from neutron diffraction experiments. The stoichiometries obtained for the $\text{LiCo}_{0.3}\text{Ni}_{0.3}\text{Mn}_{0.3}\text{Cr}_{0.1}\text{O}_2$ material is $\text{LiCo}_{0.28}\text{Ni}_{0.26}\text{Mn}_{0.8}\text{Cr}_{0.28}\text{O}_2$ from the XRD result and $\text{Li}_{0.882}\text{Co}_{0.28}\text{Ni}_{0.28}\text{Mn}_{0.3}\text{Cr}_{0.078}\text{O}_2$ from the ND result. Both results show that there are slight metal deficiencies in the material except for Mn

(ND result). Another important result is that there is also some Li deficiency in the cathode material which will affect their electrochemical performance.

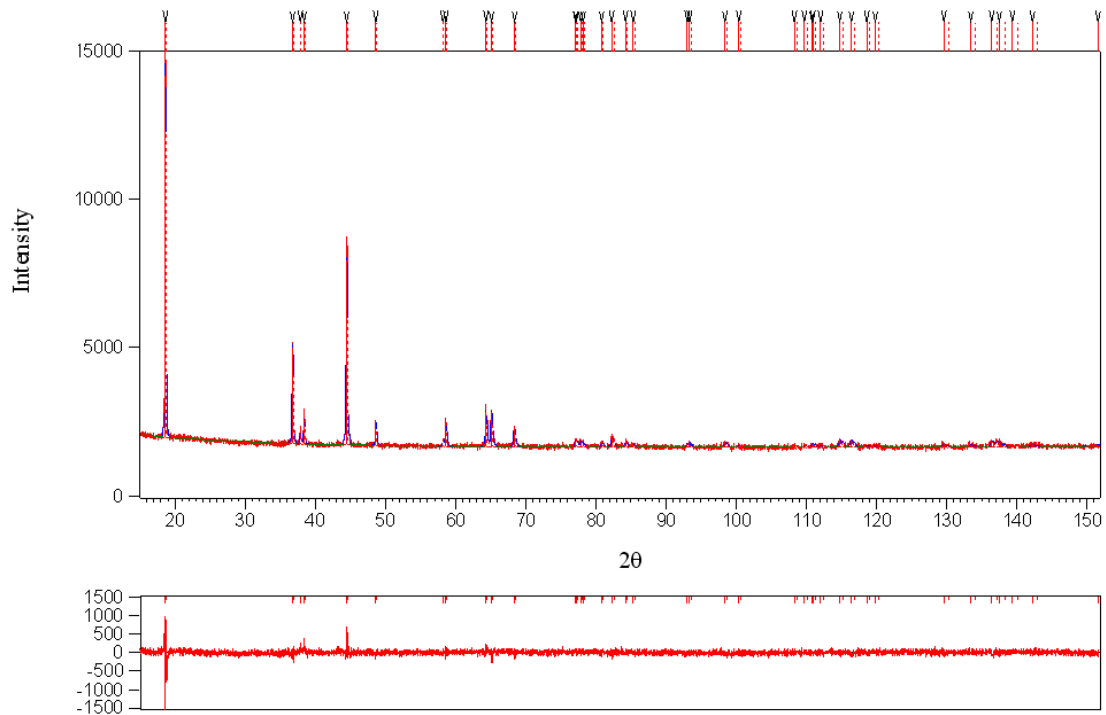

Fig. 5. Refined XRD dataset of $\text{LiCo}_{0.3}\text{Ni}_{0.3}\text{Mn}_{0.3}\text{Cr}_{0.1}\text{O}_2$

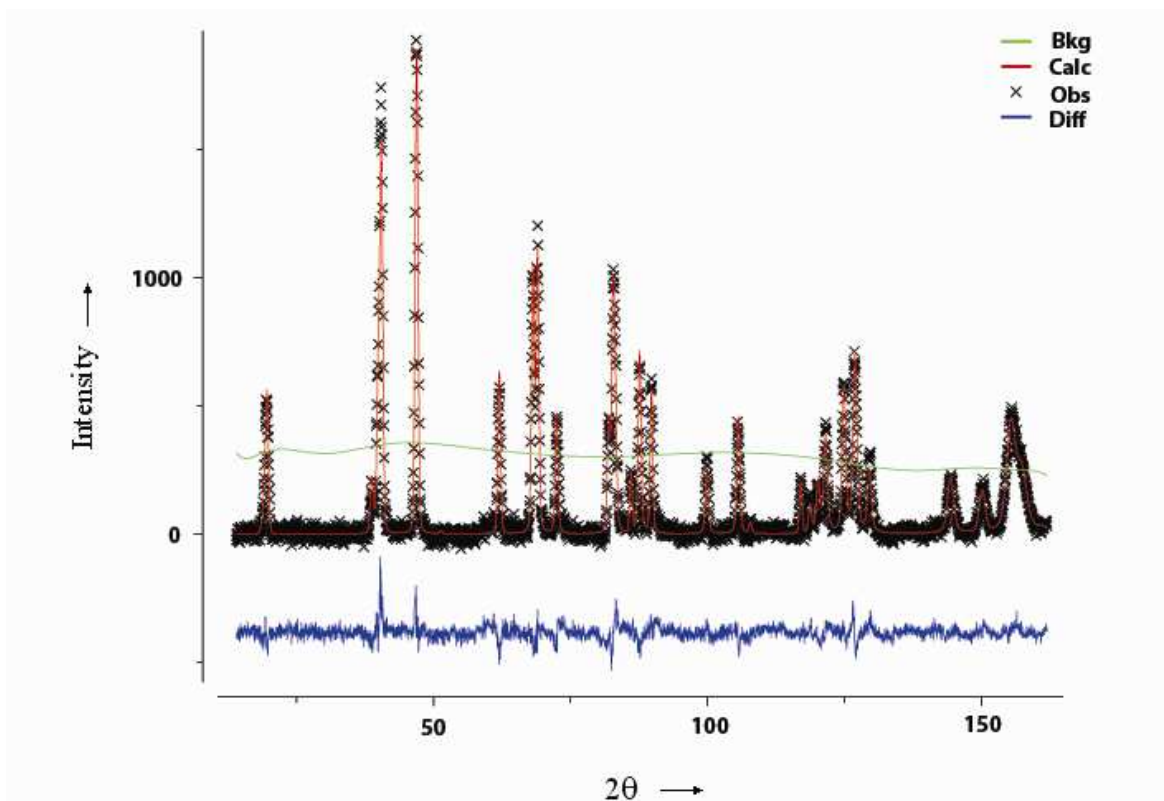

Fig. 6. Refined ND dataset of $\text{LiCo}_{0.3}\text{Ni}_{0.3}\text{Mn}_{0.3}\text{Cr}_{0.1}\text{O}_2$

Mode	s.o.f of Li	s.o.f of Co	s.o.f of Ni	s.o.f of Mn	s.o.f of Cr	R _w (%)	χ ² (%)
XRD	1.0000	0.2800	0.2600	0.2800	0.0800	3.1	1.7
ND	0.8820	0.2800	0.2800	0.3000	0.0780	6.2	1.5

Table 2. Site occupancies of Li, Co, Ni, Mn and Cr of the cathode material
LiCo_{0.3}Ni_{0.3}Mn_{0.3}Cr_{0.1}O₂

4.3 X-ray photoelectron spectroscopy

X-Ray Photoelectron Spectroscopy is a technique used to study the composition of a material, its electronic state and chemical environment. Stoichiometries of materials can be obtained by XPS through the quantitative analysis of the XPS spectrum, that is, from the narrow scans. XPS is a surface technique which can detect the compositional make-up of a sample up to about 10 nm thickness. Care must be taken to perform surface cleaning before the actual XPS measurement is done in order to get rid of surface contaminants such as carbon and oxygen. If careful precautions are taken, XPS measurements can be highly accurate and may be taken to represent the bulk.

The X-Ray Photoelectron Spectrometer is a machine that utilizes photoionization and the detection of the photoelectrons *via* an energy dispersive detector. The principle of the equipment is the ejection of electrons in a material by energetic electromagnetic waves, which is normally X-Rays. The energy of the X-Rays is given by the famous Planck equation (Wehr et al. 1978),

$$E = h\nu \quad (2)$$

where h is Planck's constant and ν is frequency. The relationship between the X-Ray energy and the kinetic energy of the photoelectrons ejected out of the orbitals of the elements in the sample material is given by,

$$h\nu = E_{KE} + \phi \quad (3)$$

where E_{KE} is the kinetic energy of the photoelectron and ϕ is the work function (also called the binding energy). Equation (3) is the famous Einstein equation by which he successfully explained the phenomenon of the photoelectric effect (Wehr et al. 1978). Thus, XPS measures the kinetic energy of the photoelectrons and calculates the binding energy. Fig. 8 illustrates the principle of the XPS. It shows the absorption of an X-Ray photon by a core electron which escapes from the atom with a specific kinetic energy. The kinetic energy of the electron is then measured by the energy dispersive detector and the characteristic binding energy can then be determined. XPS detects the first 2 to 10 nm of the top layer of a material (depending on the composition of the sample). Its detection limit is about 0.1 percent of total elemental content. A schematic of an XPS is shown in Fig. 9 showing the position of the X-Ray gun, sample chamber and detector.

Several considerations have to be made when acquiring data from an XPS. For a dual beam XPS, the X-Ray guns are usually those of Mg and Al and the best X-Ray source for the sample has to be chosen. For optimized results, peak overlaps due to very close peak positions of the elements, Auger peaks and satellite peaks of the compositional elements in

the sample must be taken into account and the right choice of X-Ray source has to be chosen. Stoichiometric information of a sample can be obtained by quantifying an XPS result. For the XPS data shown in Fig. 10, a JOEL JPS 9010 was used and the X-Ray source is Mg. This is because the $\text{LiCo}_{0.3}\text{Ni}_{0.3}\text{Mn}_{0.3}\text{Cr}_{0.1}\text{O}_2$ material is a very challenging sample to analyze containing elements with their positions very close together in the periodic table. Severe overlapping of peaks will occur if the Al source is used. The Mg k_α source produces cleaner and better resolved spectrum giving more accurate results.

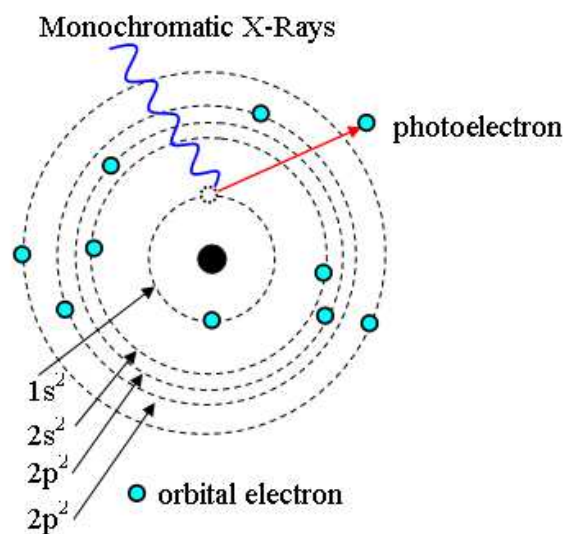

Fig. 7. X-Ray photon being absorbed by an orbital electron and escaping out of the atom with a certain kinetic energy

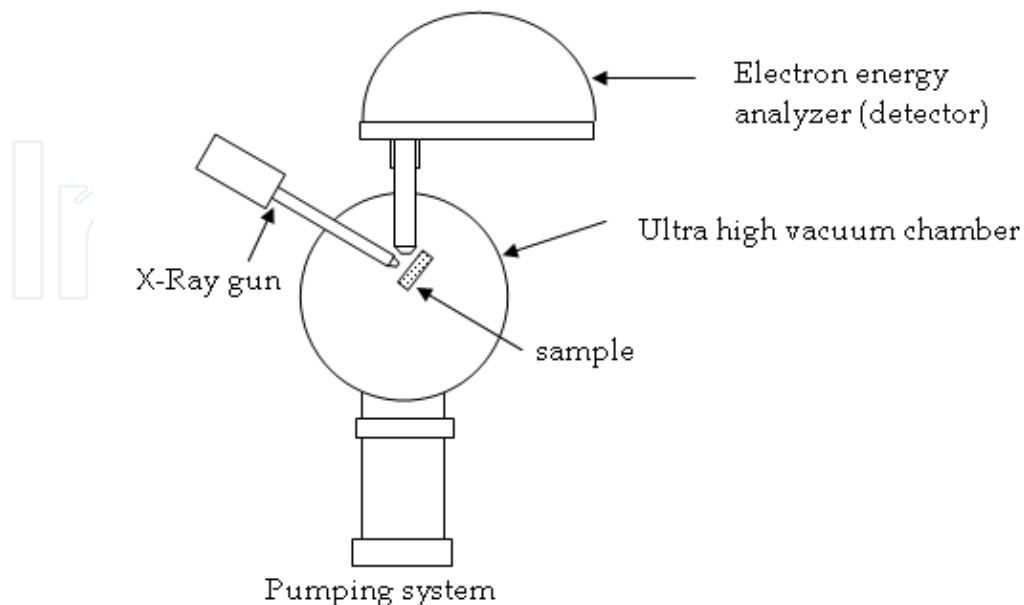

Fig. 8. Schematic of an X-Ray Photoelectron Spectrometer

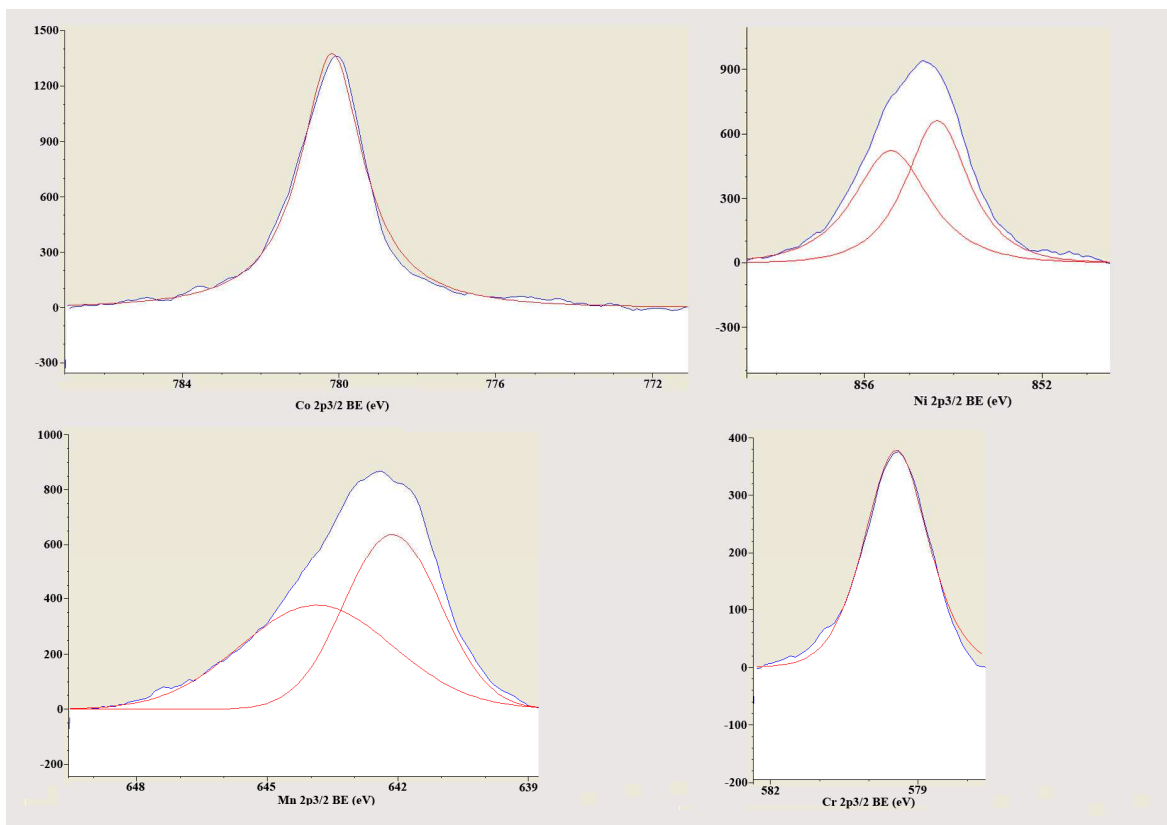

Fig. 9. XPS narrow scan of Co, Ni, Mn and Cr for $\text{LiCo}_{0.3}\text{Ni}_{0.3}\text{Mn}_{0.3}\text{Cr}_{0.1}\text{O}_2$ material

The data processing done for the results shown in Fig. 10 is background subtraction (due to inelastic scattering) using the Shirley method, smoothing using the Savitzky-Golay method and deconvolution for the Ni and Mn peaks. Results indicate the presence of two oxidation states for Mn and Ni and one oxidation state for Co and Cr. The stoichiometry elucidated from the XPS results based on the $2p_{3/2}$ orbital of the transition metals for the synthesized $\text{LiCo}_{0.3}\text{Ni}_{0.3}\text{Mn}_{0.3}\text{Cr}_{0.1}\text{O}_2$ material is $\text{LiCo}_{0.35}\text{Ni}_{0.21}\text{Mn}_{0.29}\text{Cr}_{0.15}\text{O}_2$. The result obtained for the Cr and Co content is a little lower than those obtained from the XRD and ND data but the Mn content seems to be spot on. This may be due to some surface effects of the XPS data. The slightly higher count for Cr obtained from XPS seem to agree with the TEM EDS results implying that there may be surface effects whereby Cr is hypothesized to migrate towards the surface of the sample. The surface conditions of the material may therefore, not be the same as the interior. Results however demonstrate that XPS is an acceptable method for obtaining quantitative stoichiometric values experimentally for synthesized samples with complex composition of transition metals sitting side-by-side in the periodic table. It can also give further information on the oxidation states of the transition metals which have important implications on the electrochemical behaviour of the cathode material.

5. Conclusions

For synthesized materials, it is very important to experimentally validate their stoichiometries. Several methods are available but all of them have limitations and these limitations must be considered when taking measurements. Specific techniques for some materials must be used depending on sample type and composition. Light elements are

more difficult to detect and often requires special methods, unique sample preparation and extraordinary technical considerations when performing experiments and doing data analysis. In the experimental study of elemental composition of a particular material, the elements present in the sample and their position in the periodic table has to be taken into account to check for peak overlaps or contribution to peak intensities due to other physical interactions and mechanisms. An example is Auger peaks in XPS measurements from elements in the material contributing to counts of characteristic peaks of other elements in the sample.

Method	Stoichiometry
Calculated values from synthesis	$\text{LiCo}_{0.3}\text{Ni}_{0.3}\text{Mn}_{0.3}\text{Cr}_{0.1}\text{O}_2$
EDS SEM	$\text{LiCo}_{0.3030}\text{Ni}_{0.2933}\text{Mn}_{0.2997}\text{Cr}_{0.1400}\text{O}_2$
EDS TEM	$\text{LiCo}_{0.3125}\text{Ni}_{0.2925}\text{Mn}_{0.3080}\text{Cr}_{0.0843}\text{O}_2$
XRD	$\text{LiCo}_{0.2800}\text{Ni}_{0.2600}\text{Mn}_{0.2800}\text{Cr}_{0.0800}\text{O}_2$
ND	$\text{Li}_{0.8820}\text{Co}_{0.2800}\text{Ni}_{0.3}\text{Mn}_{0.300}\text{Cr}_{0.0780}\text{O}_2$
XPS	$\text{LiCo}_{0.35}\text{Ni}_{0.21}\text{Mn}_{0.29}\text{Cr}_{0.15}\text{O}_2$

Table 3. Summary of the stoichiometry of $\text{LiCo}_{0.3}\text{Ni}_{0.3}\text{Mn}_{0.3}\text{Cr}_{0.1}\text{O}_2$ obtained experimentally from different methods and compared with calculated values

A summary of stoichiometric measurements using different methods of EDS, XRD, ND and XPS is given in Table 3. Each method has its own merits, advantages, disadvantages and limitations and the scientist sometimes has to use more than one method in order to elucidate the stoichiometry of their synthesized products. It can be said that overall, for the techniques of EDS, XRD, ND and XPS, the experimental values are reasonably close to the calculated values and to each other. More importantly, the methods used are successful in analyzing such a complex material as $\text{LiCo}_{0.3}\text{Ni}_{0.3}\text{Mn}_{0.3}\text{Cr}_{0.1}\text{O}_2$ containing a number of elements sitting side-by-side in the periodic table. Experimental determinations of the metal and transition metal composition generally indicate deficiencies from all methods except XPS which was attributed to the very narrow thickness of evaluation volume that may not be indicative of the bulk. Of the five methods used, only neutron diffraction is capable of giving Li content in the sample. Thus, experimental methods, special techniques and sample considerations are of paramount importance for the study of stoichiometries of synthesized cathode materials. Calculated stoichiometries must not be presumed and must be closely derived from experimental measurements in order to obtain reliable quantitative values of elemental compositions.

6. Acknowledgments

The authors are very grateful to Dr Max Avdeev and Mr Ned Blagojevic of ANSTO for the help in the ND experiments. The project was internally funded by the Institute of Science, Universiti Teknologi MARA and grants from the Ministry of Science, Technology and Innovation (MOSTI: 03-01-01-SF0076) and Ministry of Higher Education (MOHE), Malaysia.

7. References

- Amatucci, G.; Tarascon, J.M.; Larcher, D. and Klien, L.C. (1996). *Synthesis of electrochemically active LiCoO₂ and LiNiO₂ at 100 °C*, *Solid State Ionics*, Vol.84, pp.169-180
- Antolini, E. (2004). *LiCoO₂: formation, structure, lithium and oxygen nonstoichiometry, electrochemical behaviour and transport properties*, *Solid State Ionics*, Vol.170, pp.159-171
- David, W.I.F.; David, W.I.F.; Shankland, K.; McCusker, L.B. and Baerlocher Ch. (Eds), (2002). *Structure Determination from Powder Diffraction Data*, Oxford, ISBN 0-19-920553-1
- Ding, N.; Ge, X.W. and Chen, C.H. (2005). A new gel route to synthesize LiCoO₂ for lithium-ion batteries, *Mat. Res. Bull*, Vol.40, pp.1451-1459
- Echlin, P. ; Fiori, C.E.;Goldstein, J.I.; Joy, D.C.; Lyman, C.E. ; Lifshin, E. ; Newbury, D.E. and Romig, A.D. (1992). *Scanning electron microscopy and X-ray microanalysis*, Plenum Press ISBN 0-306-44175-6
- Fey, G.T.K.; Chen, J.G. and Subramanian, V. (2003). Electroanalytical and thermal stability studies of multi-doped lithium nickel cobalt oxides, *Journal of Power Sources*, Vol. 119–121, pp. 658–663
- Christman J.R. (1988). *Fundamentals of Solid State Physics*, John Wiley & Sons, ISBN 0-471-81095-9
- Giacovazzo, C.; Monaco, H.L.; Artioli, G.; Viterbo, D.; Ferraris, G.; Gilli, G.; Zanotti, G. and Catti, M. (2006). *Fundamentals of Crystallography*, Oxford Sc. Pub., ISBN 0-19-850958-8
- Goldstein, J.I.; Newbury, D.E. and Williams, D.B. (Ed.) (1995). *X-Ray spectrometry in electron beam instruments*, Plenum Press, ISBN 0-38-776502-6
- Huang, K.; Peng, B.; Chen, Z. and Huang, P. (2000) Preparation, structure and electrochemical properties of spinel Li_{1-x}Mn_{2-y}O₄ cathode material for lithium ion batteries, *Solar Energy Mater. & Solar Cells*, Vol. 62, pp.177-185
- Jenkins R. And Snyder R.L. (1996). *Introduction to X-Ray Powder Diffractometry*, John Wiley & Sons, ISBN 0-471-51339-3
- Joy, D.C. (1995). *Monte Carlo modeling for electron microscopy and microanalysis*, Oxford University Press, ISBN 0-19-508874-3
- Kamarulzaman, N.; Yusoff, R.; Kamarudin, N.; Shaari, N.H.; Abdul Aziz, N.A.; Bustam, M.A.; Blagojevic, N.; Elcombe, M.; Blackford, M.; Avdeev, M. and Arof, A.K. (2009) Investigation of the cell parameters, microstructures and electrochemical behaviour of LiMn₂O₄ normal and nano powders, *J. Power Sources*, Vol.188, pp.274-280
- Kittel, C.(2005). *Introduction to Solid State Physics*, John Wiley & Sons Inc, New York, ISBN 0-471-68057-5
- Klug, H.P. and Alexander, L.E. 2nd Ed. (1974). *X-Ray Diffraction Procedures*, John Wiley & Sons Inc, New York ISBN 3-900051-07
- Larson, A.C. and Von Dreele, R.B. GSAS, Los Alamos National laboratory Report Laur 86-748 (2004)
- Li, G.; Iijima, Y.; Kudo, Y. and Azuma, H. (2002). Structural Changes of Manganese Spinel at Elevated Temperatures, *Solid State Ionics*, Vol.146, pp.55-63
- Li, G.; Yamada, A.; Fukushima, Y.; Yamaura, K.; Saito, T.; Endo, T.; Azuma, H.; Sekai, K. and Nishi, Y. (2000). Phase segregation of Li_xMn₂O₄ (0.6<x<1) in non-equilibrium reduction processes, *Solid State Ionics*, Vol.130, pp.221-228

- Lide D.R.; Chief Ed. (1995) Handbook of Chemistry and Physics, CRC Press, ISBN 0-8493-0476-8
- Lu, C.H. and Saha, S.K. (2001). Morphology and electrochemical properties of LiMn_2O_4 powders derived from the sol-gel route, *Mater. Sc. and Eng.*, B79, pp.247-250
- Ohzuku, T.; Kitagawa M.; and Hirai, T. (1990) Electrochemistry of manganese dioxide in lithium nonaqueous cell. III. X-ray diffractational study on the reduction of spinel-related manganese dioxide, *J. Electrochem. Soc.*, Vol. 137, No. 3, pp.769-775
- Ohzuku, T.; Takeda, S. and Iwanaga, M. (1999). Solid-state redox potentials for $\text{Li}[\text{Me}_{1/2}\text{Mn}_{3/2}]\text{O}_4$ (Me: 3d-transition metal) having spinel-framework structures: a series of 5 volt materials for advanced lithium-ion batteries, *J. Power Sources*, Vol. 81-82, pp.90-94
- Oxford EDS manual
- Park, S.C.; Kim, Y.M.; Kang, Y.M.; Kim, K.T.; Lee, P.S. and Lee, J. Y. (2001). Improvement of the rate capability of LiMn_2O_4 by surface coating with LiCoO_2 , *J. Power Sources*, Vol. 103, pp.86-92
- Shin, Y. and Manthiram, A. (2004). Factors Influencing the Capacity Fade of Spinel Lithium Manganese Oxides, *J. Electrochem. Soc.*, Vol.151, (2), pp.A204-A208
- Tanaka, T.; Ohta, K. and Arai, N. (2001). Year 2000 R&D Status Of Large Scale Lithium Ion Secondary Batteries In the National Project Of Japan, *J. of Power Sources*, Vol.97-98, , pp. 2-6
- Toby, B.H. (2001). EXPGUI, a graphical user interface for GSAS, *J. Appl Cryst* Vol.34, pp.210-213
- U.S. Patent 2,530,110 (Filed, 1944, granted 1950)
- U.S. Patent 2,631,356 (Filed June 15, 1950. granted 1953)
- Veluchamy, A.; Ikuta, H. and Wakihara. (2001). Boron Substituted Manganese Spinel Oxide Cathode For Lithium Ion Battery, *Solid State Ionics*, Vol. 142, pp.161-171
- Wehr, M.R.; Richards, J.A.; Adair, T.W. (1978). *Physics of the Atom*, Addison-Wessley, Reading, Mass.
- Wu, C.; Wang, Z.; Wu, F.; Chen, L.; Huang, X. (2001). Spectroscopic studies on cation-doped spinel LiMn_2O_4 for lithium ion batteries, *Solid State Ionics*, Vol.144, pp.277-285
- Yamaguchi, R.; Ikuta H.; Wakihara M. (1999) Heat of Formation for $\text{LiM}_y\text{Mn}_{2-y}\text{O}_4$ (M = Co, Cr, Li, Mg, Ni) Spinel Solid Solution, *J. Therm. Anal. Calorim.*, Vol. 57 pp.797-806
- Zou, M.; Yoshio, M.; Gopukumar, S.; Yamaki, J. (2005). Performance characteristics of $\text{Li}/\text{Li}_{1-x}\text{CoO}_2$ cells, *Mater. Res. Bull.*, Vol.40, pp.708-714

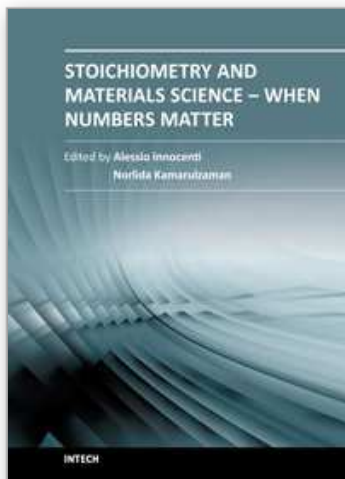

Stoichiometry and Materials Science - When Numbers Matter

Edited by Dr. Alessio Innocenti

ISBN 978-953-51-0512-1

Hard cover, 436 pages

Publisher InTech

Published online 11, April, 2012

Published in print edition April, 2012

The aim of this book is to provide an overview on the importance of stoichiometry in the materials science field. It presents a collection of selected research articles and reviews providing up-to-date information related to stoichiometry at various levels. Being materials science an interdisciplinary area, the book has been divided in multiple sections, each for a specific field of applications. The first two sections introduce the role of stoichiometry in nanotechnology and defect chemistry, providing examples of state-of-the-art technologies. Section three and four are focused on intermetallic compounds and metal oxides. Section five describes the importance of stoichiometry in electrochemical applications. In section six new strategies for solid phase synthesis are reported, while a cross sectional approach to the influence of stoichiometry in energy production is the topic of the last section. Though specifically addressed to readers with a background in physical science, I believe this book will be of interest to researchers working in materials science, engineering and technology.

How to reference

In order to correctly reference this scholarly work, feel free to copy and paste the following:

Norlida Kamarulzaman and Mohd Hilmi Jaafar (2012). Synthesis and Stoichiometric Analysis of a Li-Ion Battery Cathode Material, *Stoichiometry and Materials Science - When Numbers Matter*, Dr. Alessio Innocenti (Ed.), ISBN: 978-953-51-0512-1, InTech, Available from: <http://www.intechopen.com/books/stoichiometry-and-materials-science-when-numbers-matter/synthesis-and-stoichiometric-analysis-of-some-li-ion-battery-cathode-materials>

INTECH
open science | open minds

InTech Europe

University Campus STeP Ri
Slavka Krautzeka 83/A
51000 Rijeka, Croatia
Phone: +385 (51) 770 447
Fax: +385 (51) 686 166
www.intechopen.com

InTech China

Unit 405, Office Block, Hotel Equatorial Shanghai
No.65, Yan An Road (West), Shanghai, 200040, China
中国上海市延安西路65号上海国际贵都大饭店办公楼405单元
Phone: +86-21-62489820
Fax: +86-21-62489821

© 2012 The Author(s). Licensee IntechOpen. This is an open access article distributed under the terms of the [Creative Commons Attribution 3.0 License](#), which permits unrestricted use, distribution, and reproduction in any medium, provided the original work is properly cited.

IntechOpen

IntechOpen