

We are IntechOpen, the world's leading publisher of Open Access books Built by scientists, for scientists

4,800

Open access books available

122,000

International authors and editors

135M

Downloads

Our authors are among the

154

Countries delivered to

TOP 1%

most cited scientists

12.2%

Contributors from top 500 universities



WEB OF SCIENCE™

Selection of our books indexed in the Book Citation Index
in Web of Science™ Core Collection (BKCI)

Interested in publishing with us?
Contact book.department@intechopen.com

Numbers displayed above are based on latest data collected.

For more information visit www.intechopen.com



Quantum Dots as a Light Indicator for Emitting Diodes and Biological Coding

Irati Ugarte¹, Ivan Castelló²,
Emilio Palomares² and Roberto Pacios¹
¹Ikerlan S. Coop
²ICIQ Institut Català d'Investigació Química
Spain

1. Introduction

Quantum dots (QDs) are inorganic semiconductor particles that exhibit size and shape dependent optical and electronic properties (Alivisatos, 1996; Smith & Nie, 2010). Due to the typical dimension in the range of 1-100 nm, the surface-to-volume ratios of the materials become large and their electronic states become discrete. Moreover, due to the fact that the size of the semiconductor nanocrystal is smaller than the size of the exciton, charge carriers become spatially confined, which raises their energy (quantum confinement). Thus, the size and shape-dependent optoelectronic properties are attributed to the quantum confinement effect. Because of this effect, light emission from these particles can be tuned, throughout the ultraviolet, visible and near infrared spectral ranges.

Quantum dots possess many advantages that make them interesting for several applications:

- They show symmetrical and **narrow emission** spectra and **broad absorption** spectra, enabling that a single light source can be used to excite multicolour quantum dots simultaneously without signal overlap.
- They have a **brighter emission** and a **higher signal to noise ratio** compared with organic dyes.
- Their **stability** is due to its inorganic composition which reduces the effect of photobleaching compared to organic dyes.
- The **lifetime** of the excited states that give rise to fluorescence in quantum dots is about 10 to 40ns, which is longer than the few nanoseconds observed for organic dyes.
- The **large Stokes shift** (difference between peak absorption and peak emission wavelengths) reduces autofluorescence, which increases sensitivity to detect particular wavelengths.
- QDs have **high quantum yields** in the visible range (0.65-0.85 for CdSe) as well as for the NIR (0.3-0.7 for PbS), while organic dyes are moderate in the NIR (0.05-0.25).

Figure 1 shows an example of different size CdSe based nanoparticles narrow emission and broad absorption spectra. Both were excited at the same wavelength of 390 nm to record the emission.

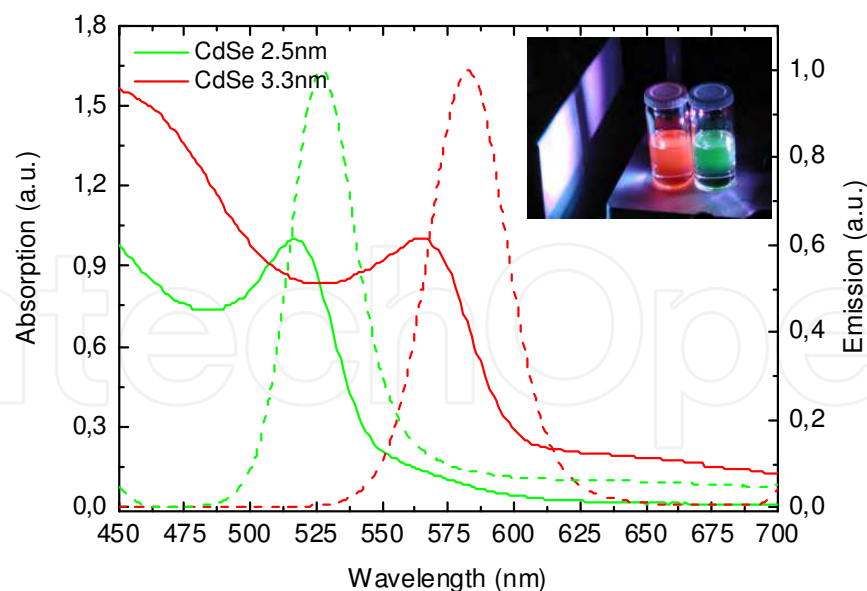

Fig. 1. Emission and absorption spectra of different size CdSe nanocrystals.

All these features make QDs excellent candidates for fluorescent probes. Such multicolour emission enables multiplexed optical coding of biomolecules for biomedical applications, for molecular and cellular imaging and ultrasensitive detection (Bruchez et al., 1998; Han et al., 2001).

Moreover, QDs are not only used for biological detection technologies but diverse applications. Intensive research is carried out for their use in optoelectronic devices, such as light emitting diodes (Coe et al., 2002; Colvin et al., 1994), thermoelectric devices (Harman et al., 2002) and photovoltaic devices (Milliron et al., 2005).

In addition, QDs inserted in an electroluminescent polymer matrix can modify the intrinsic emission of the polymer, very interesting for many industry applications.

Taking into account the advantageous properties of colour tunability of these inorganic semiconductor particles, different research technologies along with the latest experimental results on both topics -biological detection and electroluminescent devices- will be discussed throughout this chapter.

2. Quantum dots for electroluminescence devices

A new technology based on organic light emitting diodes (OLEDs) is revolutionizing the display industry that has been dominated in the past three decades by liquid-crystal displays (LCDs). OLEDs are no longer an exclusively research activity but approaching industrial applications. However, QD-based light emitting diodes (QD-LEDs) have emerged as a competitive choice and they have attracted intense research and commercialization efforts over the last decade. Colloidal quantum dots, which consist of nanometer diameter inorganic semiconductor crystals surrounded by surface passivating organic ligands, are particularly attractive because they can be solution processed and are compatible with low cost, OLED printing techniques. Although this QD-LED technology is still relatively new, it presents promising advantages compared to its organic counterpart. These are as follows:

- Full width at half maximum (FWHM) of the emission peak from QDs is only 20-30nm, depending on the monodispersity achieved during the colloidal synthesis. Besides, organic electroluminescent materials' FWHM is more than 50nm. Therefore, QD-LEDs present better potential for high quality image and colour contrast and saturation. Attending to the Commission International de l'Eclairage (CIE) chromaticity diagram which defines different colour saturation and hues, the triangle representing possible QD emission is larger than the HDTV (High Definition Television) standard. In figure 2, both HDTV and QD emission triangles are represented in the CIE chromaticity diagram.

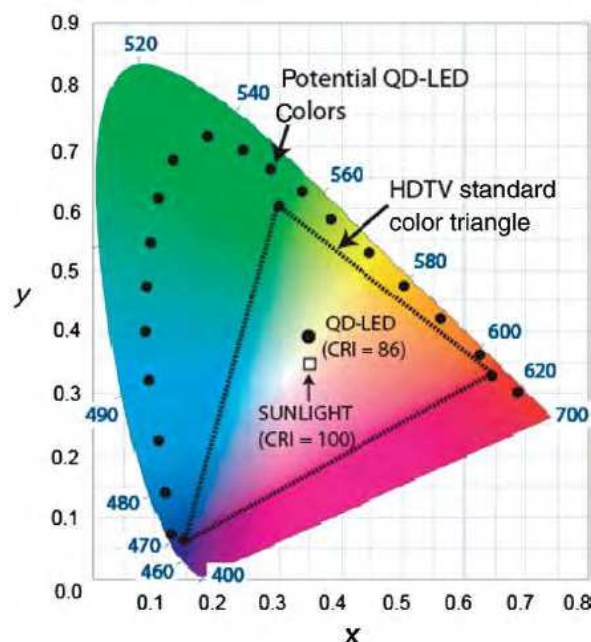

Fig. 2. CIE chromaticity diagram showing that the spectral purity of QDs enables a colour gamut larger than the HDTV standard. Source: (Wood & Bulovic, 2010).

- Under operating at high brightness and/or high current, *Joule* heat could turn towards device degradation problems. Inorganic materials' thermal stability is usually higher than organic ones. Therefore, inorganic materials based devices are expected to exhibit longer lifetimes.
- Different colours for OLEDs are achieved by different materials, involving different degradation rates and lifetimes for each one. This means that display colour of these devices generally changes with time. However, in QD-LEDs all of the three primary colours can be obtained with the same composition changing the particle size. Due to the same composition and thus, similar lifetime, the display colour variation in quantum-dot-based devices could be less pronounced.
- The emission spectra for QD-LEDs can reach the IR range, while is rather difficult to overcome the 650nm peak emission of OLEDs. With QDs, for example, CdSe of different sizes provide emission from the blue through the red, while QDs made of a smaller band gap material, such as PbSe, PbS, or CdTe, offer spectral tunability in the NIR spectral region. In figure 3, different size and composition QD emission spectra are depicted. It demonstrates the possibility to achieve a really wide range of different emission wavelengths.

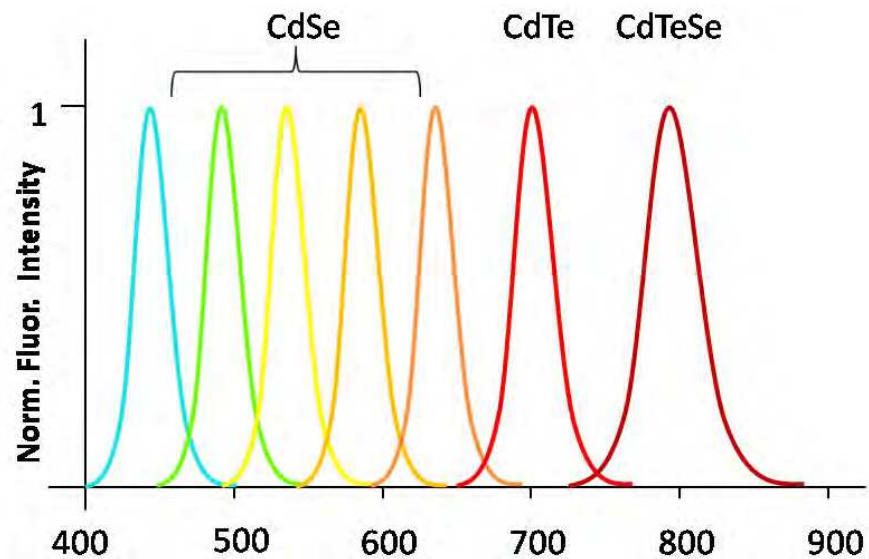

Fig. 3. Different size and composition QD emission spectra.

- Spin statistics are not restrictive for QDs. In organic fluorescent materials, where the singlet to triplet state formation ratio is 1:3, the efficiency is limited to 25% because only the singlet state recombination results in fluorescence (Carvelli et al., 2011). Therefore, theoretically, using QDs higher external quantum efficiency (EQE) could be achieved comparing to organic electroluminescent materials.

On the other hand, concerning solid state lighting applications, warmer white is preferred over the bluish white. QDs can be used to tune the quality of white lighting; by adding QD lumophores to the phosphors used to fabricate the LED it is possible to achieve warmer white light. Figure 4 represents the emission spectra of a standard LED bulb and a QD added LED bulb.

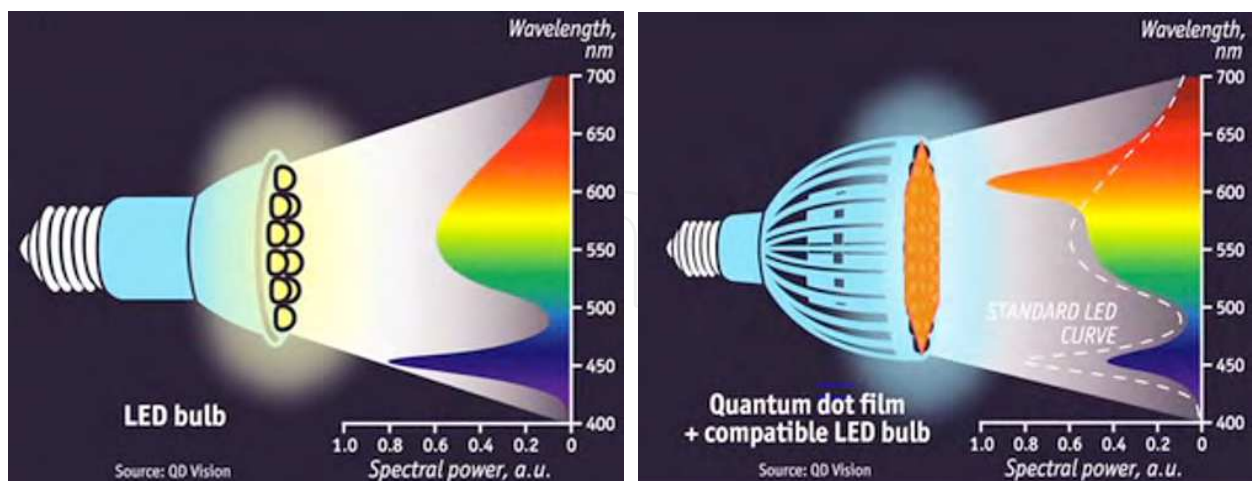

Fig. 4. Standard and QD added LED bulb emission spectra. Source: QD Vision.

The basic structure of QD-LED is similar to the OLED architecture. Basically, a QD layer is sandwiched between electron and hole transporting materials. An applied electric field causes electrons and holes to move into the QD layer where they recombine forming excitons and emitting photons.

Figure 5 represents the basic structure and the electron-hole recombination that occurs in a QD-LED device.

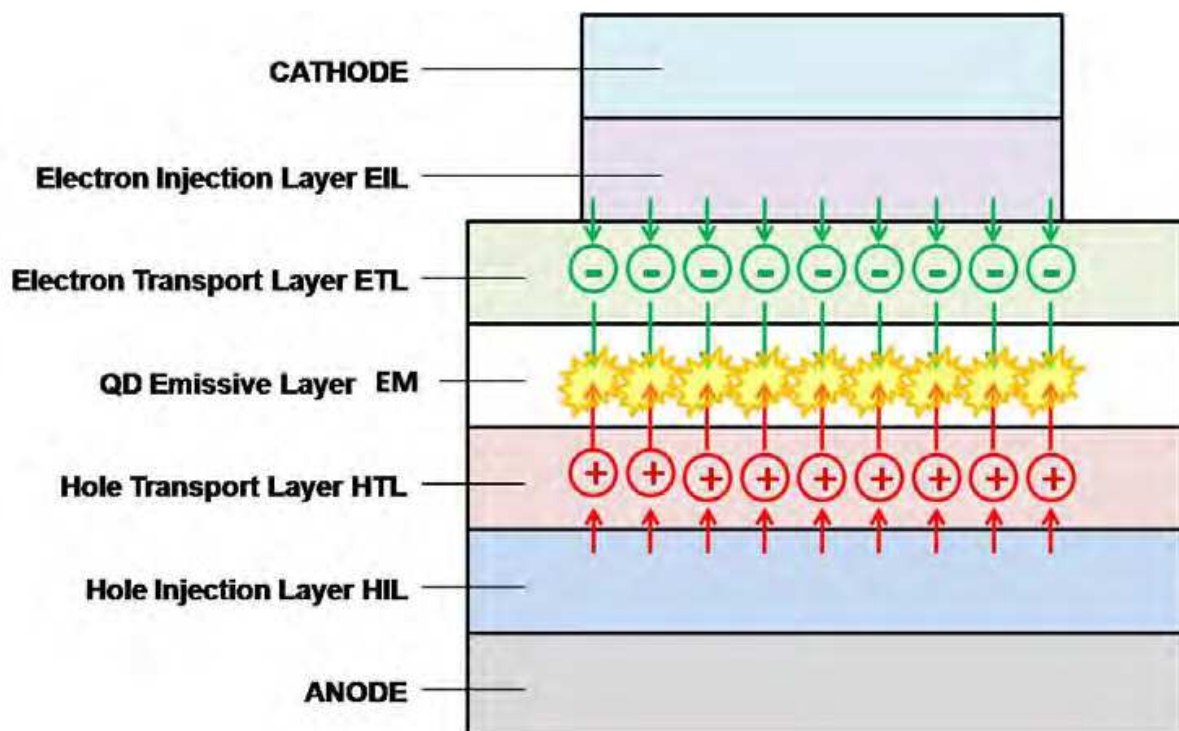

Fig. 5. QD-LED basic structure and exciton generation.

Although the QD-LED potential is impressive, pure organic LEDs are still brighter, they have longer lifetimes and show much higher efficiency than QD-LEDs. OLED devices are already on the market and are widely used in several applications. However, QD-LED will surely find a niche in the market owing to their high colour purity, as the emission linewidth is in the order of 30 nm and the wavelength can, in principle, be tuned continuously from UV to infrared. Moreover, the combination of both organic materials and inorganic QDs in optoelectronic devices can be an interesting approach to achieve efficient and high-throughput products.

3. Polymer-QD blend light emitting diodes

The integration of organic and inorganic materials at the nanometre scale into hybrid light emitting devices (HYLEDs) combines the ease of processability of organic materials with the high-performance electronic and optical properties of inorganic nanocrystals.

The first QD-polymer-based hybrid electroluminescent (EL) device was demonstrated in 1994 (Colvin et al., 1994), showing relatively low EQE (0.01%). They used spin-coated poly-(phenylene vinylene) (PPV) polymer as hole transport layer and a multilayer film of cadmium selenide nanocrystals as emitting as well as electron transport layer. PPV was also used in many other early QD-LED devices (Mattoussi et al., 1998; Schlamp et al., 1997) but the EQE was still low (<1%).

In 2002, a QD-LED structure only consisting on a single monolayer of QDs, sandwiched between two organic thin films demonstrated considerably better device performance (Coe

et al., 2002). This sandwiched structure was achieved making use of the material phase segregation effect that takes place between the QD aliphatic capping groups (in this case trioctyl phosphine oxide, TOPO) and the aromatic organic materials.

The limiting aspect of these devices based on pure CdSe QD films was the poor hole mobility ($\sim 10^{-12}$ cm²/V in contrast to $\sim 10^{-4}$ cm²/V for electron mobility) associated to the high hole trap density (Ginger & Greenham, 2000). However, this hole mobility can be compensated by using metal oxides as hole transporting layers (Caruge et al., 2006, 2008). In this work NiO and tris-(8-hydroxyquinoline) aluminium (Alq₃) were used as hole and electron transporting layers, respectively. In this work NiO and tris-(8-hydroxyquinoline) aluminium (Alq₃) were used as hole and electron transporting layers, respectively. Figure 6 represents the electroluminescence (EL) spectra and EQE at different applied bias of the first QD-LED using metal oxide charge transport layers.

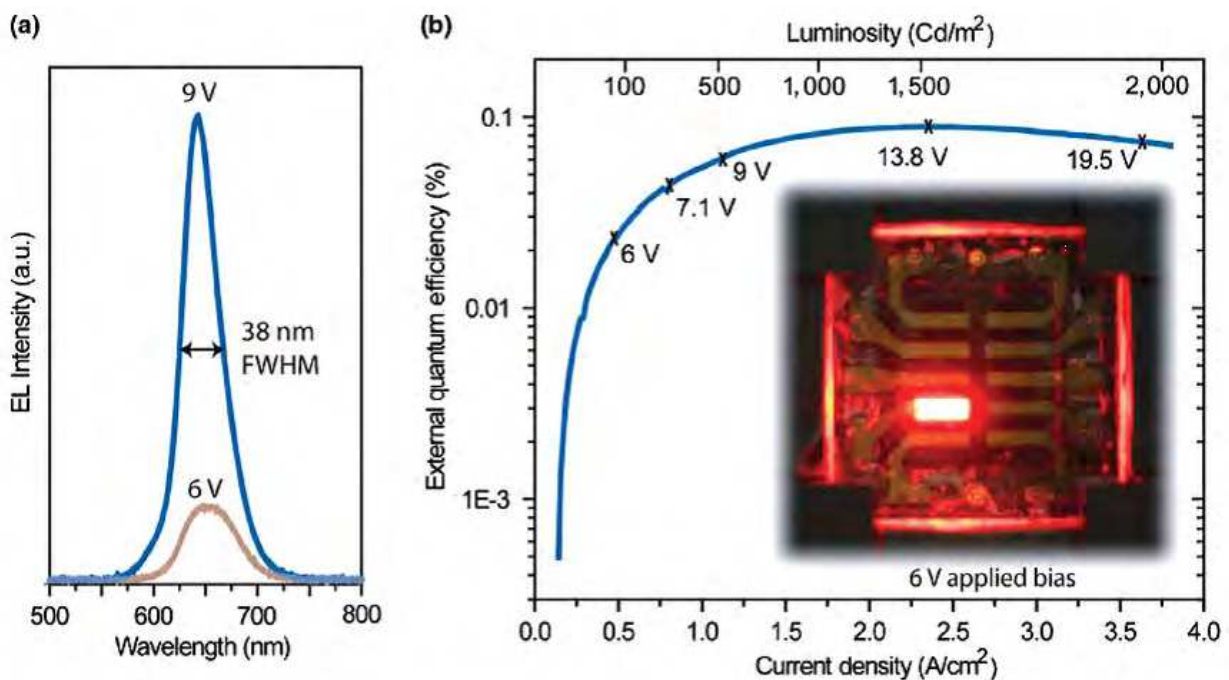

Fig. 6. a) EL spectra and b) external quantum efficiency at different applied bias of the QD-LED developed by Caruge et al.

Besides metal oxides, different charge transport layers have been used for QD-LEDs. Usually organic materials present faster hole mobility than QDs. Therefore, as it was mentioned before, first QD-LEDs were PPV-based devices. Other several research studies carried out in this field used *N,N'*-diphenyl-*N,N'*-bis(3-methylphenyl)-1-1'-biphenyl-4,4'-diamine (TPD) as hole transport layer (Coe-Sullivan et al., 2005; Coe et al., 2002; Sun et al., 2007). Blue emitting electroluminescent poly(9,9-dioctylfluorene) (PFO), for example, allows hole mobility in the range of $\sim 10^{-3}$ - 10^{-5} cm²/V depending on the processing technique (Kreouzis et al., 2006). A single active layer consisting of PFO doped with CdSe QD showed around 0.5% EQE (Campbell & Crone, 2008).

Further optimization was obtained by multilayer QD-LEDs, where the thicknesses of the QD and organic layers could be varied independently (Zhao et al., 2006). By optimizing the thicknesses of the constituent QD layers of devices, improved electroluminescent efficiency

(around 2-3 cd/A), low turn-on voltages (3-4 V) and long operation lifetimes were developed (Sun et al., 2007).

Table 1 summarizes the performance evolution for different QD-LED device architectures reported in literature.

Emitting λ (nm)	$V_{\text{turn-on}}$ (V)	L_{max} (cd/m ²)	Efficacy (cd/A)	Efficiency (lm/W)	EQE (%)	Device structure	Citation
610	4	100	--	--	> 0.01	ITO / CdSe / PPV / Mg & ITO / PPV / CdSe / Mg	(Colvin et al., 1994)
560	4	600			0.2	ITO / PPV / CdSe - CdS / Mg:Ag	(Schlamp et al., 1997)
600	3-3.5				0.1	ITO / PPV (multilayer) / CdSe / Al	(Mattoussi et al., 1998)
560	3.5	2000	1.9		0.52	ITO / TPD / CdSe-ZnS / Alq ₃ / Mg:Ag & ITO / TPD / CdSe-ZnS / TAZ / Alq ₃ / Mg:Ag	(Coe et al., 2002)
615	3	7000	2.0	1.0	2	ITO / TPD / CdSe / Alq ₃ / Mg:Ag / Ag	(Coe-Sullivan et al., 2005)
625		3000			0.18	ITO / NiO / CdSe-ZnS / Alq ₃ / Ag:Mg / Ag	(Caruge et al., 2006)
517 (G) 546 (Y) 589 (O) 600 (R)	4 (G) 5 (Y) 3 (O) 3 (R)	3700 (G) 4470 (Y) 3200 (O) 9064 (R)	1.1-2.0 (G-R)	<1.1		ITO / PEDOT:PSS / poly-TPD / CdS-ZnS / Alq ₃ / Ca:Al	(Sun et al., 2007)
600	1.9	12380		2.41		ITO / PEDOT:PSS / TFB / CdSe-CdS-ZnS / TiO ₂ / Al	(Cho et al., 2009)
470 (B) 540 (G) 600 (R)		4200 68000 31000		0.17 8.2 3.8		ITO / PEDOT:PSS / poly-TPD / CdS-ZnS / ZnO / Al	(Lei Qian et al., 2011)

Table 1. Performance evolution of different QD-organic LED devices.

Technological development and the accumulation of fundamental knowledge, such as designing new device structures and formulating the composition and structure of the QDs, has led to rapidly improve the performance of these devices. As a result, combining an organic hole transport layer and an inorganic metal oxide electron transport layer with the emissive QD films (Cho et al., 2009; Lei Qian et al., 2011) devices showed maximum luminance and power efficiency values over 4200cd/m² and 0.17lm/W for blue emission, 68000cd/m² and 8.2lum/W for green emission, and 31000 cd/m² and 3.8lm/W for red emission. Moreover, with the incorporation of ZnO nanoparticles, these devices exhibit high environmental stability and longer operating lifetimes.

On the other hand, the integration of QDs into a full-colour LED structure requires successful individual red-green-blue (RGB) QD patterning for a pixelated active display panel. The most widely used method to fabricate monochromatic devices, spin coating, results in mixing the pixel colours. More recently, inkjet (Tekin et al., 2007) and contact printing (L. Kim et al., 2008; T.H. Kim et al., 2011) processes have been proposed as alternative methods for QD patterning. These techniques demand intensive efforts to optimize film uniformity and flat surface morphology in order to ensure the good performance of devices.

Although improving the performance is the key requisite in all optoelectronic devices, other characteristics, as colour tunability of a single emissive layer or ease of processing, could give QD-LEDs an extra added value to be used in specific applications.

3.1 Light tunability of hybrid polymer-QD-based LEDs. Applications as light indicators

Light tunability is an attractive characteristic for a diverse amount of application fields. In this context, QD-LEDs have attracted great attention because they are able to tune the outgoing light by not only varying the composition but also by controlling the size and shape of the QD.

In patterned matrix display systems, a variety of colours are possible by changing the relative intensities of the red-green-blue (RGB) subpixels. Moreover, combining QDs with organic emitting materials can provide a wide range colour emitting devices (Anikeeva et al., 2009).

In addition to displays, different colour emission from the same device would be highly desirable for some applications like ambient light at wish and distinctive indicators of a systems state (polarity, voltage, pressure indicators, etc.). Therefore, all RGB components together in the same film are required.

Unlike green and red components, the blue component (440-490nm) of the visual spectrum is characterized by low luminous efficacies. Besides, the diminutive dimension QDs needed to achieve the blue component adds more difficulty to enhance the efficiency of bright-blue QD-LEDs. Therefore, the synergic combination of organic and inorganic semiconducting materials can lead to obtain a single layer that contains all RGB components. As it was mentioned before, PFO, whose hole mobility is much higher than CdSe, can be the blue emitter while green and red emission can be achieved from quantum dots. In figure 7, all RGB components from both organic and inorganic materials are represented: the blue emission corresponds to PFO while green and red emissions correspond to different size CdSe QDs.

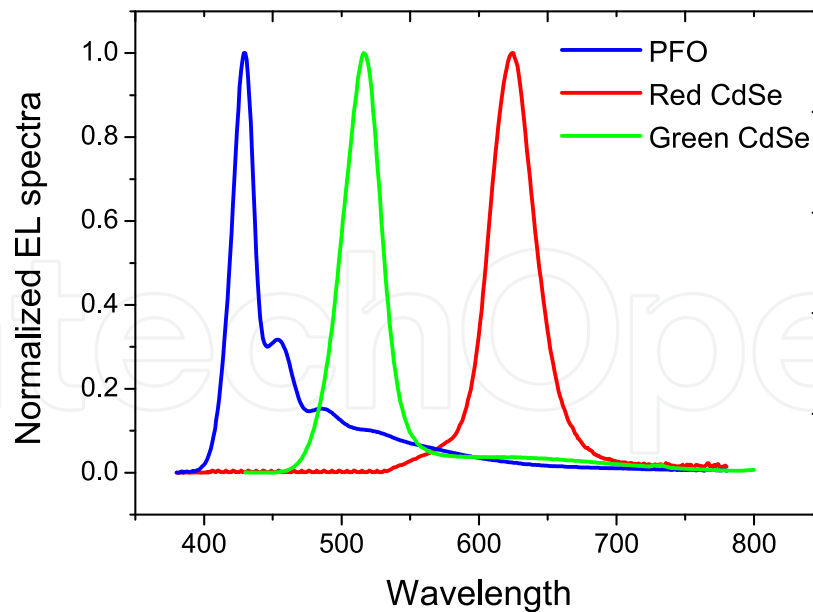

Fig. 7. All RGB components from blue emitting PFO (organic), green emitting 2.2nm CdSe particles and red emitting 5.8 nm CdSe particles.

Once all RGB components can be achieved, white emission is also feasible by adjusting the balance between these three constituents. White emission from polymer-QD based LEDs is very attractive for mainly lighting purposes. For general room lighting, the challenge to obtain low consumption devices combined with the ability to vary the colour temperature of a lamp is the major advantage offered by this type of light emitting devices. Moreover, due to the mechanical properties of the organic films, the possibility to achieve very thin and even flexible devices could allow new and modern lighting designs.



Fig. 8. Ultrathin and flexible character of OLED and HYLEDS could allow new and modern lighting designs. Different OLED lamp prototype from Novaled.

Several research studies demonstrate that it is possible to reach white light in organic or hybrid polymeric-inorganic diodes by blending different materials with emission in RGB

(Chou et al., 2007; Huang et al., 2010; Luo et al., 2007). Luo et al. developed high efficiency white-light emitting diodes using a single copolymer. Fluorescent red, green and blue chromophores were introduced in a conjugated polymer backbone as emissive layer, resulting in a stable white light with 6.2 cd/A luminance efficiency. On the other hand, in the work developed by Chou et al. the fabrication and characterization of white-emitting HYLEDs was reported. The emissive layer of these devices was based on PFO as the blue emitter and CdSe/ZnS as the yellow emitter. Contrary to the multilayer structure used in this work, in the activity performed by Huang et al. the green and red QDs were incorporated into the PFO as the single emissive layer. Minimizing the number of layers that have to be used involves simplifying the device structure and the fabrication process, an important requisite in order to be potentially introduced in the market as high throughput and low cost devices.

Green emission from oxidized PFO has been in detail studied mainly by means of photoluminescence (Ferenczi et al., 2008; Sims et al., 2004). These works demonstrate that a green emission band at 535nm arises due to the formation of oxidation-induced fluorenone defects. The generation of fluorenone defects during diode operation has been documented in different experiments (Ouisse et al., 2003; Ugarte et al., 2009). These studies conclude that the spectral shift of polyfluorene-based LEDs was enhanced by the current passing through the device. One could benefit from this characteristic in order to obtain combined blue and green emission from a single polymer emissive layer.

In figure 9, deliberately oxidized PFO and non-oxidized PFO based OLEDs EL spectra are depicted. The polymer solution oxidation was achieved by annealing in excess the original polyfluorene solution.

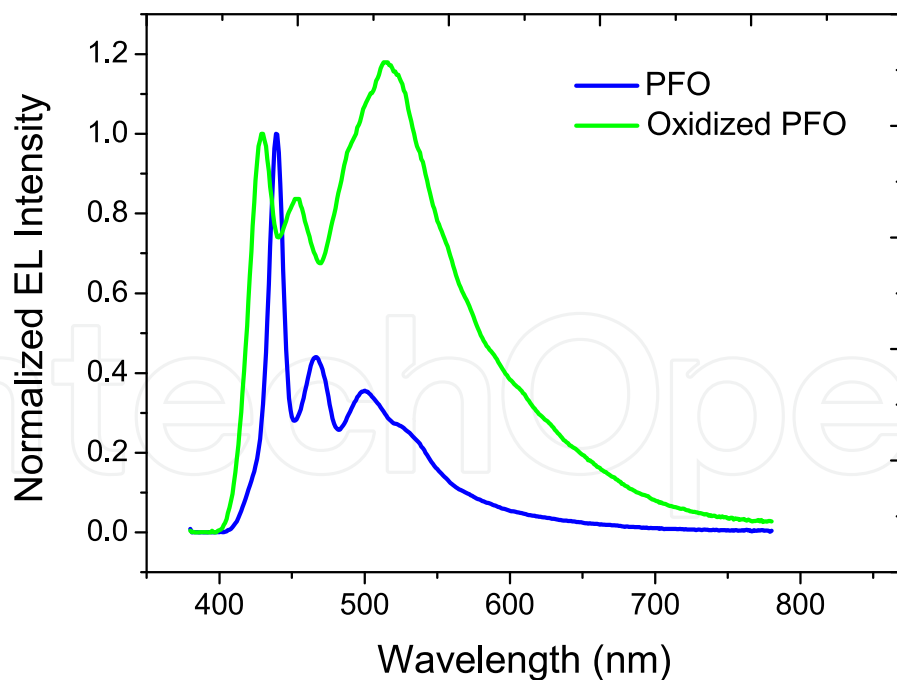

Fig. 9. EL spectra for different OLEDs based on PFO (blue line) and deliberately oxidized PFO solution (green line).

Additionally, blending the polymer solution with red emitting colloidal CdSe QDs, all three RGB components are possible in the same emitting film.

Blending two different materials could give rise to Förster Resonance Energy Transfer (FRET) if certain conditions are fulfilled. Basically, the absorption of the guest has to overlap the emission of the host. If additionally, these different materials (polymer chains and QD nanoparticles) are within a minimum distance (Förster radius) the emitted energy by the host is absorbed and re-emitted by the guest (Buckley et al., 2001; Cabanillas-Gonzalez et al., 2005). Therefore, in order to make use of emission from both materials a very precise control of the nanoscale phase-segregation is necessary.

In this way, by varying polymer:QD ratio, colour tunable light emitting devices can be achieved. In figure 10, different ratio PFO-CdSe devices EL emission is depicted.

For a certain PFO:QD ratio, emission from RGB components are balanced and the desired white emission is also feasible (green line in figure 9).

On the other hand, the observed tunability does not only depend on the polymer:QD ratio but also on the applied bias. Voltage tunable emission has been reported in both polymer-QD (Chou et al., 2007; Ugarte et al., 2009) and polymer-polymer (Berggren et al., 1994) devices. Materials with different composition and miscibility properties that consequently tend to phase separate, can simultaneously emit if they are excited at once. Due to the different charge injection properties in both phases, light emission from these micrometre-sized domains depends on the turn on applied voltage. In this case, for low applied bias emission from the polymer is predominant, while increasing the voltage, emission from both materials allows to redshift the spectra.

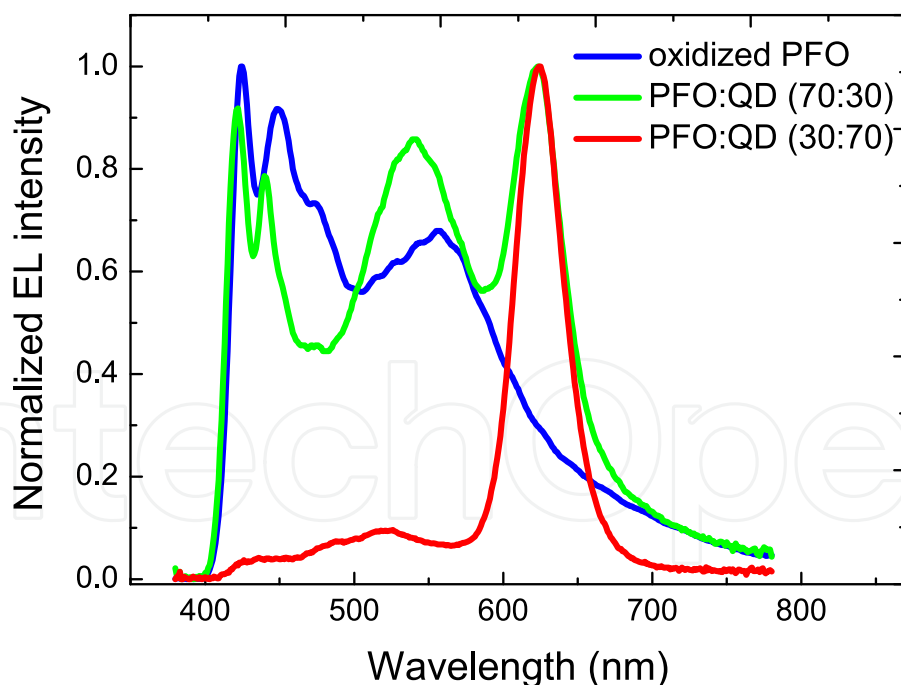

Fig. 10. Oxidized PFO-based device (blue line) and different ratio PFO-QD-based device (red and green lines) emission.

Figure 11 shows the voltage dependent EL spectrum of a HYLEd containing PFO: CdSe (70:30) electro-active film. The same device can emit towards either blue or red depending on the externally applied voltage.

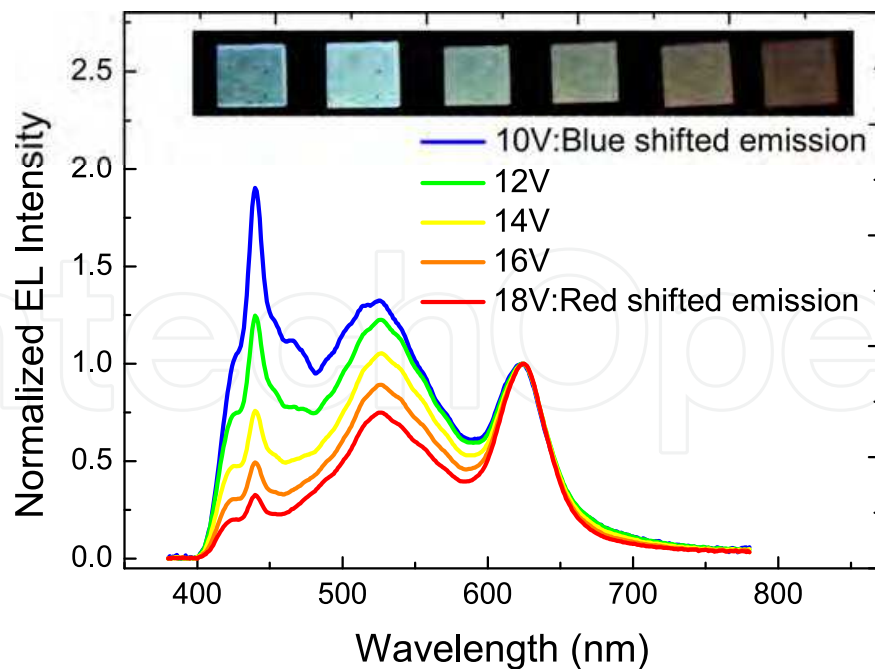

Fig. 11. Colour tunability varying the voltage in a PFO-QD (70-30) based emissive film.

This interesting characteristic, the voltage tunability that covers the whole visible spectrum, will give an extra added value in optoelectronic devices for many applications; from general lighting to distinctive indicators of a system state (voltage, pressure, pH etc.).

Recently, other studies demonstrate a monolithic, full-colour, tunable inorganic LED (Hong et al., 2011). This inorganic device is based on multifaceted gallium nitride (GaN) nanorod arrays with $\text{In}_x\text{Ga}_{1-x}\text{N}/\text{GaN}$ multiple quantum wells (MQWs) anisotropically formed on the nanorod tips and sidewalls.

In figure 12 is shown the LED developed by Hong et al. at different applied bias.



Fig. 12. Color tunability varying the voltage in a PFO-QD (70-30) based emissive film. Source: (Hong et al., 2011).

Although lower voltage values are needed for these purely inorganic devices, they require more complex fabrication processes that could limit their use to economic and low consumption devices. Therefore, QD-polymer LEDs present the simplicity and advantages of a monolithic and single-layer device with the thin, flexible and ease of processing characteristics provided by organic optoelectronic technology.

4. Different QD blends for biological coding

Biomedicine and bioengineering are research areas where most important and revolutionary advances have been carried out during the last decades. Analysis of biological molecules is

one of the most important activities in these fields, where a large number of proteins and nucleic acids have to be rapidly studied and/or screened. Thus, the development of a fast and efficient coding procedure for biomolecules that could allow high-throughput analysis would be desirable. In this context, the possibility to achieve new labels and barcodes that can be miniaturized is one of the major challenges. Up to date, a variety of multiplex encoding techniques (chemical, physical, electronic, spectrometric etc.) have been developed. One of the most attractive strategies, the spectrometric encoding, provides a large quantity of codes combined by operational simplicity. Amongst the different available spectra, as Raman or FTIR, fluorescence-based methods are probably the simplest in decoding. Moreover, due to the variety of fluorescence techniques established on the market, fluorescence is one of the most important encoding method.

Although so far organic dyes have mostly been used as fluorescent codes, the use of QD nanoparticles has attracted great interest in the last years. Compared with traditional organic dyes, fluorescent QDs offer unique photochemical and photophysical properties (Resch-Genger et al., 2008). Moreover, they show longer photostability and lower photobleaching compared to organic dyes (Bruchez Jr et al., 1998; Wu et al., 2003). Figure 13 represents the comparison of the fluorescence intensity evolution in time between organic fluorophores (Alexa 488) and inorganic quantum dots (QD 608).

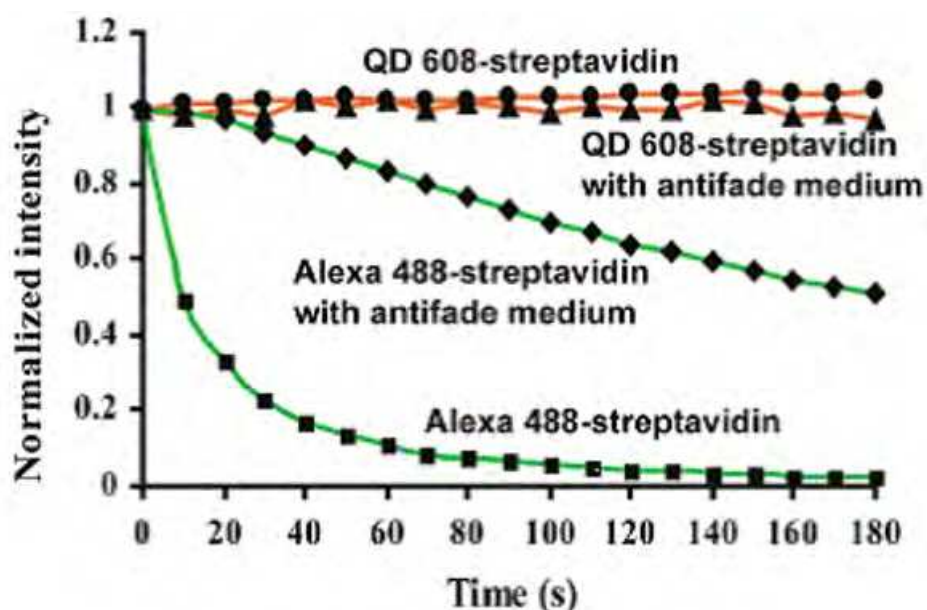

Fig. 13. Fluorescence intensity evolution in time of QD 608 and organic dye Alexa 488, measured every 10 s for 3 minutes. QD fluorescence intensity remains stable while the organic dye is degraded after few seconds. Source: (Wu et al., 2003).

Their principal advantage over their organic counterparts is that due to their symmetrical and narrow emission spectra and broad absorption spectra it is possible to use a single light source to simultaneously excite different quantum dots. Therefore, exciting different QD blends at a certain wavelength, even small amounts of QD are clearly detectable in the fluorescence spectra. Figure 14 represents the PL spectra of different blends obtained by mixing, in different ratios, individual CdSe populations. One of them emits at 532nm while the other emits at 582nm.

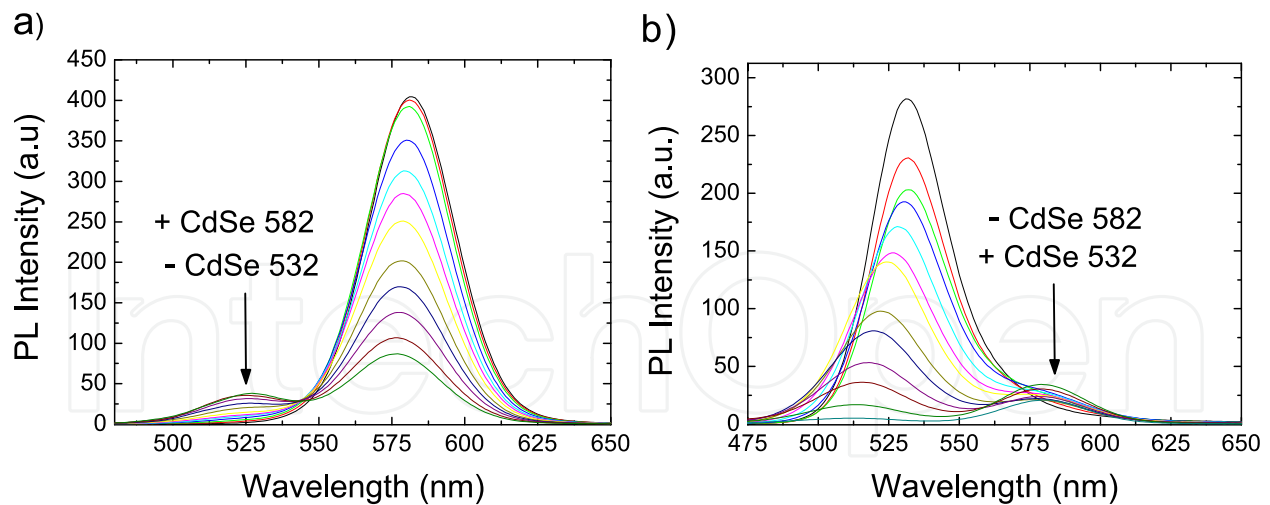

Fig. 14. Photoluminescence intensity of two different size quantum dot blends. a) Addition of small amounts of 532nm emitting CdSe nanoparticles to 582nm emitting population are detectable by photoluminescence measurements. b) In the same way, small amounts of 582nm emitting QD in 532nm population are detectable.

In addition, due to the larger Stokes shift of QDs their autofluorescence is considerably reduced leading to an increased sensitivity.

Therefore, in the last decade these robust and bright light emitters have opened the door to a variety of biological applications, such as fluorescent labels for cellular labeling, deep-tissue and tumor imaging agents and drug-delivery nanoparticles amongst others (Alivisatos et al., 2005; Wu et al., 2003).

Concerning fluorescence labelling, multiplexing with QDs offers the possibility of simultaneous excitation and discriminated emission, allowing more compact and less step required detection systems. The working principle of multiplexed coding is based on the combination of different emission wavelength (colour) QDs and different intensity levels. In this way, combining, for example, 6 colours and 10 intensity levels would theoretically enable one million of different possible codes.

In figure 15, the PL spectra and the measured intensity as a function of the blend composition are represented. The particular composition of each blend can be identified by both QD intensity levels and emission wavelength peaks. At the same time, each blend can be associated to a target molecule for bioidentification applications.

Embedding the nanoparticles into microbeads is crucial in order to allow binding to biomolecules by functionalization of these fluorescent labels. Moreover, in case of non-water soluble QDs, it is vital to ensure the biocompatibility of QDs with the biological environment.

Therefore, the ability to incorporate multicolour QDs into micron-size polymer beads at precisely controlled ratios is the critical step preparation for efficient, homogeneous and biocompatible encoding labels. Currently, there are two basic technologies mostly used for multiplexed QD encoded beads:

1. Trapping of different colour QDs directly into the beads.

2. Direct *in situ* encapsulation of QDs during the bead synthesis and later shell formation of different colour QDs on the surface of the bead.

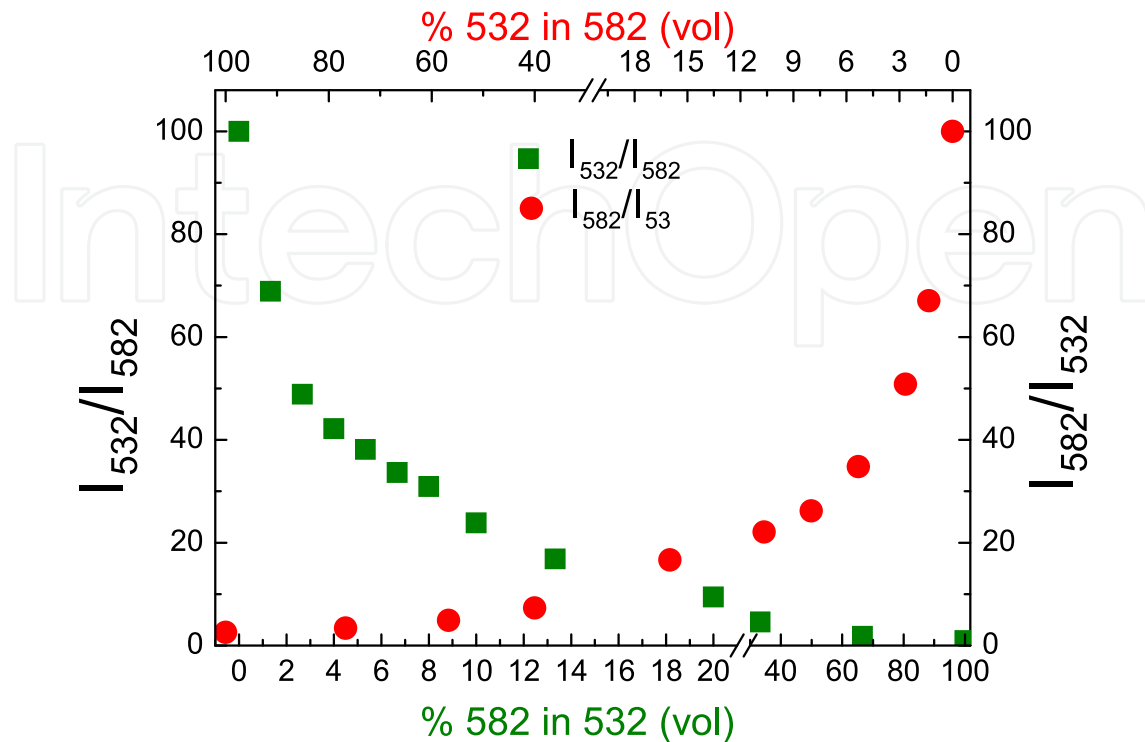

Fig. 15. Intensity pattern obtained from blending two different populations of CdSe QD in different ratios.

Trapping of QDs directly into polymeric beads was first developed by Nie and coworkers (Han et al., 2001). Dissolving the polymeric beads (in this case polystyrene) in chloroform/alcohol QDs solution, the inorganic nanoparticles were embedded into the spheres due to the swelling of the beads. Not only single colour QDs were inserted by this method but also three colour QDs in different ratios were combined increasing the number of possible encoding labels.

Figure 16 represents a fluorescence image obtained from a mixture of CdSe/ZnS QD-tagged beads emitting different single-colour signals (Han et al., 2001). First, different colour QD populations were synthesized and embedded into polystyrene beads; then, different beads were blended altogether in a single dispersion and finally these beads were spread on a glass substrate.

The direct *in situ* encapsulation of QDs consist of embedding the nanoparticles into the spheres during the polymerization of the beads. In order to achieve multiplexed colour encoded tags, a different colour QD shell has to be formed on the surface of previously synthesized bead (Ma et al., 2011). In the work developed by Palomares and coworkers multiplexed colour encoded nanospheres were fabricated encapsulating different colour QD/silica layers and result in highly efficient photoluminescent nanospheres with monodisperse, photostable, and excellent luminescence properties. Moreover, this technique based on a "layer by layer" QD-bead system ensures to avoid any possible electron transfer between different QD populations due to the physical silica barrier separation.

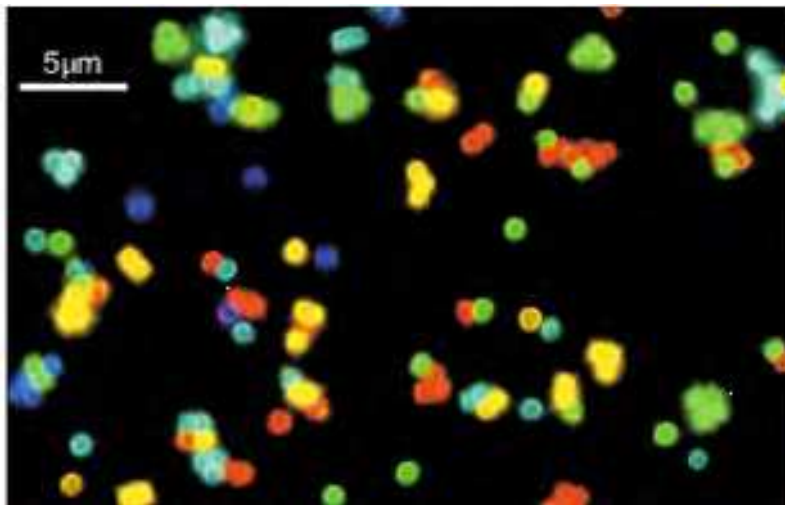

Fig. 16. Fluorescence image of a mixture of CdSe/ZnS tagged beads emitting different single-colour signals. Source: (Han et al., 2001).

Figure 17 represents the core-shell QD/silica procedure to prepare three different colour QD beads.

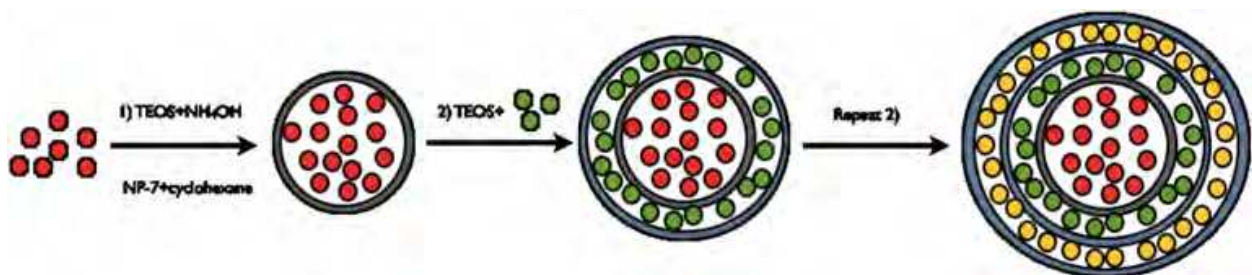

Fig. 17. Illustration of the procedure used to prepare of multiplexed colour encoded silica nanospheres encapsulating QDs multilayers. Source: (Ma et al., 2011).

The combination of different size-colour QDs for core and shell fabrication with the variation of different QD ratios enables multiple different labels or codes that could allow high-throughput analysis of biomolecules.

5. Conclusion

Due to their unique electrical and optical properties, quantum dots are excellent candidates to be used as indicators in very diverse applications. Not only size, shape and composition dependent colour but also high quantum yield and stability against photobleaching are the key of their potential success in many areas from electronics to biology and medical diagnostics.

In the field of light emitting diodes, they can be combined either with other different size QDs or organic electroluminescent materials in order to fabricate tunable light emitting devices.

In the same way, embedding and coating different size QDs onto microbeads can lead to create multiple optical codes for biomedical applications.

6. References

- Alivisatos, A. P. (1996). Semiconductor clusters, nanocrystals, and quantum dots. *Science*, Vol. 271, No. 5251, (February 1996), pp. (933-937), 00368075.
- Alivisatos, A. P., Gu, W., & Larabell, C. (2005). Quantum dots as cellular probes. *Annual review of Biomedical Engineering*, Vol. 7, (April 2005), pp. (55-76), 15239829.
- Anikeeva, P.O., Halpert, J. E., Bawendi, M. G., & Bulovic', V. (2009). Quantum dot light-emitting devices with electroluminescence tunable over the entire visible spectrum. *Nano Letters*, Vol. 9, No. 7, (July 2009), pp. (2532-2536), 15306984.
- Berggren, M., Inganäs, O., Gustafsson, G., Rasmussen, J., Andersson, M. R., Hjertberg, T., & Wennerström, O. (1994). Light emitting diodes with variable colours from polymer blends. *Nature*, Vol. 372, No. 6505, (December 1994), pp. (444-446), 00280836.
- Bruchez Jr, M., Moronne, M., Gin, P., Weiss, S., & Alivisatos, A. P. (1998). Semiconductor nanocrystals as fluorescent biological labels. *Science*, Vol. 281, No. 5385, (September 1998), pp. (2013-2016), 00368075.
- Buckley, A. R., Rahn, M. D., Hill, J., Cabanillas-Gonzalez, J., Fox, A. M., & Bradley, D. D. C. (2001). Energy transfer dynamics in polyfluorene-based polymer blends. *Chemical Physics Letters*, Vol. 339, No. 5-6, (May 2001), pp. (331-336), 00092614.
- Cabanillas-Gonzalez, J., Virgili, T., Lanzani, G., Yeates, S., Ariu, M., Nelson, J., et al. (2005). Photophysics of charge transfer in a polyfluorene/violanthrone blend. *Physical Review B - Condensed Matter and Materials Physics*, Vol. 7, No. 1, (January 2005), pp. (014211-1-014211-8), 10980121.
- Campbell, I. H., & Crone, B. K. (2008). Efficient, visible organic light-emitting diodes utilizing a single polymer layer doped with quantum dots. *Applied Physics Letters*, Vol. 92, No. 4, (2008), Article number (043303), 00036951.
- Caruge, J. M., Halpert, J. E., Bulovic, V., & Bawendi, M. G. (2006). NiO as an inorganic hole-transporting layer in quantum-dot light-emitting devices. *Nano Letters*, Vol. 6, No. 12, (December 2006), pp. (2991-2994), 15306984.
- Caruge, J. M., Halpert, J. E., Wood, V., Bulovic, V., & Bawendi, M. G. (2008). Colloidal quantum-dot light-emitting diodes with metal-oxide charge transport layers. *Nature Photonics*, Vol. 2, No. 4, (April 2008), pp. (247-250), 17494885.
- Carvelli, M., Janssen, R. A. J., & Coehoorn, R. (2011). Determination of the exciton singlet-to-triplet ratio in single-layer organic light-emitting diodes. *Physical Review B - Condensed Matter and Materials Physics*, Vol. 83, No. 7, (February 2011), Article number (075203), 10980121.
- Coe-Sullivan, S., Steckel, J. S., Woo, W. K., Bawendi, M. G., & Bulovic', V. (2005). Large-area ordered quantum-dot monolayers via phase separation during spin-casting. *Advanced Functional Materials*, Vol. 15, No. 7, (July 2005), pp. (1117-1124), 1616301X.
- Coe, S., Woo, W. K., Bawendi, M., & Bulovic', V. (2002). Electroluminescence from single monolayers of nanocrystals in molecular organic devices. *Nature*, Vol. 420, No. 6917, (December 2002), pp. (800-803), 00280836.
- Colvin, V. L., Schlamp, M. C., & Alivisatos, A. P. (1994). Light-emitting diodes made from cadmium selenide nanocrystals and a semiconducting polymer. *Nature*, Vol. 370, No. 6488, (August 1994), pp. (354-357), 00280836.

- Cho, K. S., Lee, E. K., Joo, W. J., Jang, E., Kim, T. H., Lee, S. J., Kwon, S. -J., Han, J. Y., Kim, B. -K., Choi, B. L., Kim, J. M. (2009). High-performance crosslinked colloidal quantum-dot light-emitting diodes. *Nature Photonics*, Vol. 3, No. 6, (June 2009), pp. (341-345), 17494885.
- Chou, C. H., Yang, C. H., Hsu, C. S., & Chen, T. M. (2007). Hybrid white-light emitting-LED based on luminescent polyfluorene polymer and quantum dots. *Journal of Nanoscience and Nanotechnology*, Vol. 7, No. 8, (August 2007), pp. (2785-2789), 15334880.
- Ferenczi, T. A. M., Sims, M., & Bradley, D. D. C. (2008). On the nature of the fluorenone-based emission in oxidized poly(dialkyl-fluorene)s. *Journal of Physics Condensed Matter*, Vol. 20, No. 4, (January 2008), Article number (045220), 09538984.
- Ginger, D. S., & Greenham, N. C. (2000). Charge injection and transport in films of CdSe nanocrystals. *Journal of Applied Physics*, Vol. 87, No. 3, (February 2000), pp. (1361-1368), 00218979.
- Han, M., Gao, X., Su, J. Z., & Nie, S. (2001). Quantum-dot-tagged microbeads for multiplexed optical coding of biomolecules. *Nature Biotechnology*, Vol. 19, No. 7, (July 2001), pp. (631-635), 10870156.
- Harman, T. C., Taylor, P. J., Walsh, M. P., & LaForge, B. E. (2002). Quantum dot superlattice thermoelectric materials and devices. *Science*, Vol. 297, No. 5590, (September 2002), pp. (2229-2232), 00368075.
- Hong, Y. J., Lee, C. -H., Yoon, A., Kim, M., Seong, H. -K., Chung, H. J., Sone, C., Park, Y. J. & Yi, G. -C. (2011). Visible-color-tunable light-emitting diodes. *Advanced Materials*, Vol. 23, No. 29, (August 2011), pp. (3284-3288), 09359648.
- Huang, C. Y., Huang, T. S., Cheng, C. Y., Chen, Y. C., Wan, C. T., Madhava Rao, M. V., Su, Y. K. (2010). Three-band white light-emitting diodes based on hybridization of polyfluorene and colloidal CdSe-ZnS quantum dots. *IEEE Photonics Technology Letters*, Vol. 22, No. 5, (March 2010), pp. (305-307), 10411135.
- Kim, L., Anikeeva, P. O., Coe-Sullivan, S. A., Steckel, J. S., Bawendi, M. G., & Bulovic', V. (2008). Contact printing of quantum dot light-emitting devices. *Nano Letters*, Vol. 8, No. 12, (December 2008), pp. (4513-4517), 15306984.
- Kim, T. H., Cho, K. S., Lee, E. K., Lee, S. J., Chae, J., Kim, J. W., Kim, D. H., Kwon, J.-Y., Amaratunga, G., Lee, S.Y., Choi, B. L., Kuk, Y., Kim, J. M., & Kim, K. (2011). Full-colour quantum dot displays fabricated by transfer printing. *Nature Photonics*, Vol. 5, No. 3, (March 2011), pp. (176-182), 17494885.
- Kreuzis, T., Poplavskyy, D., Tuladhar, S. M., Campoy-Quiles, M., Nelson, J., Campbell, A. J., Bradley, D. D. C., (2006). Temperature and field dependence of hole mobility in poly(9,9- dioctylfluorene). *Physical Review B - Condensed Matter and Materials Physics*, Vol. 73, No. 23, (2006), Article number (235201), 10980121.
- Lei Qian, Y. Z., Jiangeng Xue & Paul H. Holloway (2011). Stable and efficient quantum-dot light-emitting diodes based on solution-processed multilayer structures. *Nature photonics*, (August 2011), 17494885.
- Luo, J., Li, X., Hou, Q., Peng, J., Yang, W., & Cao, Y. (2007). High-efficiency white-light emission from a single copolymer: Fluorescent blue, green, and red chromophores

- on a conjugated polymer backbone. *Advanced Materials*, Vol. 19, No. 8, (April 2007), pp. (1113-1117), 09359648.
- Ma, Q., Castelló Serrano, I., & Palomares, E. (2011). Multiplexed color encoded silica nanospheres prepared by stepwise encapsulating quantum dot/SiO₂ multilayers. *Chemical Communications*, Vol. 47, No. 25, (2011), pp. (7071-7073), 13597345.
- Mattoussi, H., Radzilowski, L. H., Dabbousi, B. O., Thomas, E. L., Bawendi, M. G., & Rubner, M. F. (1998). Electroluminescence from heterostructures of poly(phenylene vinylene) and inorganic CdSe nanocrystals. *Journal of Applied Physics*, Vol. 83, No. 12, (June 1998), pp. (7965-7974), 00218979.
- Milliron, D. J., Gur, I., & Alivisatos, A. P. (2005). Hybrid organic-nanocrystal solar cells. *MRS Bulletin*, Vol. 30, No. 1, (January 2005), pp. (41-44), 08837694.
- Ouisse, T., Stephan, O., & Armand, M. (2003). Degradation kinetics of the spectral emission in polyfluorene light-emitting electro-chemical cells and diodes. *EPJ Applied Physics*, Vol. 24, No. 3, (December 2003), pp. (195-200), 12860042.
- Resch-Genger, U., Grabolle, M., Cavaliere-Jaricot, S., Nitschke, R., & Nann, T. (2008). Quantum dots versus organic dyes as fluorescent labels. *Nature Methods*, Vol. 5, No. 9, pp. (763-775), 15487091.
- Schlamp, M. C., Peng, X., & Alivisatos, A. P. (1997). Improved efficiencies in light emitting diodes made with CdSe(CdS) core/shell type nanocrystals and a semiconducting polymer. *Journal of Applied Physics*, Vol. 82, No. 11, (December 1997), pp. (5837-5842), 00218979.
- Sims, M., Bradley, D. D. C., Ariu, M., Koeberg, M., Asimakis, A., Grell, M., Lidzey, D. G. (2004). Understanding the origin of the 535 nm emission band in oxidized poly(9,9-dioctylfluorene): The essential role of inter-chain/inter-segment interactions. *Advanced Functional Materials*, Vol. 14, No. 8, (August 2004), pp. (765-781), 1616301X.
- Smith, A. M., & Nie, S. (2010). Semiconductor nanocrystals: Structure, properties, and band gap engineering. *Accounts of Chemical Research*, Vol. 43, No. 2, (February 2010), pp. (190-200), 00014842.
- Sun, Q., Wang, Y. A., Li, L. S., Wang, D., Zhu, T., Xu, J., Yan, C., Li, Y. (2007). Bright, multicoloured light-emitting diodes based on quantum dots. *Nature Photonics*, Vol. 1, No. 12, (December 2007), pp. (717-722), 17494885.
- Tekin, E., Smith, P. J., Hoepfener, S., Van Den Berg, A. M. J., Susa, A. S., Rogach, A. L., et al. (2007). InkJet printing of luminescent CdTe nanocrystal-polymer composites. *Advanced Functional Materials*, Vol. 17, No. 1, (January 2007), pp. (23-28), 1616301X.
- Ugarte, I., Cambarau, W., Waldauf, C., Arbeloa, F. L., & Pacios, R. (2009). Precisely voltage tunable polymeric light emitting diodes by controlling polymer chemical oxidation and adding inorganic semiconducting nanoparticles. From blue to red stopping at white in the same device. *Organic Electronics*, Vol. 10, No. 8 (December 2009), pp. (1606-1609), 15661199.
- Wood, V., & Bulovic, V. (2010). Colloidal quantum dot light-emitting devices. *Nano Reviews*, Vol. 1, (July 2010), 5202.

- Wu, X., Liu, H., Liu, J., Haley, K. N., Treadway, J. A., Larson, J. P., Ge, N., Peale, F., Bruchez, M.P. (2003). Immunofluorescent labeling of cancer marker Her2 and other cellular targets with semiconductor quantum dots. *Nature Biotechnology*, Vol. 21; No. 1, (January 2003), pp. (41-46), 10870156.
- Zhao, J., Bardecker, J. A., Munro, A. M., Liu, M. S., Niu, Y., Ding, I. K., Luo, J., Chen, B., Jen, A. K.-Y., Ginger, D. S., (2006). Efficient CdSe/CdS quantum dot light-emitting diodes using a thermally polymerized hole transport layer. *Nano Letters*, Vol. 6, No. 3, (March 2006), pp. (463-467), 15306984.

IntechOpen

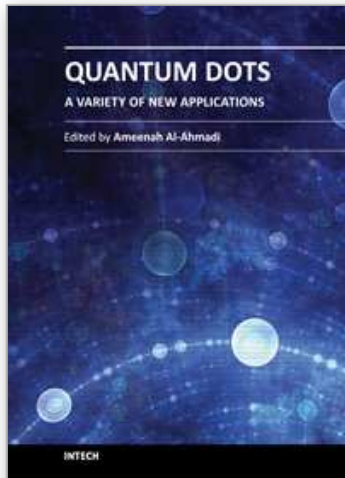

Quantum Dots - A Variety of New Applications

Edited by Dr. Ameenah Al-Ahmadi

ISBN 978-953-51-0483-4

Hard cover, 280 pages

Publisher InTech

Published online 04, April, 2012

Published in print edition April, 2012

The book “Quantum dots: A variety of a new applications” provides some collections of practical applications of quantum dots. This book is divided into four sections. In section 1 a review of the thermo-optical characterization of CdSe/ZnS core-shell nanocrystal solutions was performed. The Thermal Lens (TL) technique was used, and the thermal self-phase Modulation (TSPM) technique was adopted as the simplest alternative method. Section 2 includes five chapters where novel optical and lasing application are discussed. In section 3 four examples of quantum dot system for different applications in electronics are given. Section 4 provides three examples of using quantum dot system for biological applications. This is a collaborative book sharing and providing fundamental research such as the one conducted in Physics, Chemistry, Biology, Material Science, Medicine with a base text that could serve as a reference in research by presenting up-to-date research work on the field of quantum dot systems.

How to reference

In order to correctly reference this scholarly work, feel free to copy and paste the following:

Irati Ugarte, Ivan Castelló, Emilio Palomares and Roberto Pacios (2012). Quantum Dots as a Light Indicator for Emitting Diodes and Biological Coding, Quantum Dots - A Variety of New Applications, Dr. Ameenah Al-Ahmadi (Ed.), ISBN: 978-953-51-0483-4, InTech, Available from: <http://www.intechopen.com/books/quantum-dots-a-variety-of-new-applications/quantum-dots-as-a-light-indicator-for-emitting-diodes-and-biological-coding>

INTECH
open science | open minds

InTech Europe

University Campus STeP Ri
Slavka Krautzeka 83/A
51000 Rijeka, Croatia
Phone: +385 (51) 770 447
Fax: +385 (51) 686 166
www.intechopen.com

InTech China

Unit 405, Office Block, Hotel Equatorial Shanghai
No.65, Yan An Road (West), Shanghai, 200040, China
中国上海市延安西路65号上海国际贵都大饭店办公楼405单元
Phone: +86-21-62489820
Fax: +86-21-62489821

© 2012 The Author(s). Licensee IntechOpen. This is an open access article distributed under the terms of the [Creative Commons Attribution 3.0 License](#), which permits unrestricted use, distribution, and reproduction in any medium, provided the original work is properly cited.

IntechOpen

IntechOpen