

We are IntechOpen, the world's leading publisher of Open Access books Built by scientists, for scientists

4,800

Open access books available

122,000

International authors and editors

135M

Downloads

Our authors are among the

154

Countries delivered to

TOP 1%

most cited scientists

12.2%

Contributors from top 500 universities



WEB OF SCIENCE™

Selection of our books indexed in the Book Citation Index
in Web of Science™ Core Collection (BKCI)

Interested in publishing with us?
Contact book.department@intechopen.com

Numbers displayed above are based on latest data collected.

For more information visit www.intechopen.com



Train Braking

Cătălin Cruceanu
*University POLITEHNICA of Bucharest
Romania*

1. Introduction

Train braking is a very complex process, specific to rail vehicles and of great importance by the essential contribution on the safety of the traffic. This complexity results from the fact that during braking occur numerous phenomena of different kinds - mechanical, thermal, pneumatic, electrical, etc. The actions of these processes take place in various points of the vehicles and act on different parts of the train, with varying intensities. The major problem is that all must favorably interact for the intended scope, to provide efficient, correct and safe braking actions.

The purpose of braking action is to perform controlled reduction in velocity of the train, either to reach a certain lower speed or to stop to a fixed point. In general terms, this happens by converting the kinetic energy of the train and the potential one - in case of circulation on slopes - into mechanical work of braking forces which usually turns into heat, which dissipates into the environment.

At first, the rather low locomotives power and traction force allowed braking using quite simple handbrakes that equipped locomotives and eventually other vehicles of the train. As the development of rail transport and according to increasing traffic speeds, tonnages and length of trains, it was found that braking has to be centralized, operated from a single location - usually the locomotive driver's cabin and commands have to be correctly transmitted along the entire length of the train.

As a consequence, along the time, for railway vehicles have been developed various brake systems, whose construction, design and operation depend on many factors such as running speed, axle load, type, construction and technical characteristics of vehicles, traffic conditions, etc.

Among various principles and constructive solutions that were developed, following the studies and especially the results of numerous tests, the indirect compressed air brake system proved to have the most important advantages. Therefore, it was generalized and remains even nowadays the basic and compulsory system for rail vehicles.

It is still to notice that, regarding the classical systems used for railway vehicles, there are also several major challenges that may affect the braking capacity. These aspects must be very well known and understood, so as to find appropriate solutions in such a manner that the problems to be overcome by applying different constructive, functional, operational and other kinds of measures.

For example, one of these issues is the basic braking systems dependency on the adhesion between wheel and rail, which can lead to wheel blocking during braking. This determines not only the lengthen of the stopping distance, but also the development of flat places on the rolling surface of wheels, generating strong shocks transmitted both to the way and to the vehicle, with damage to traffic safety and comfort of passengers or goods transported integrity. This has generated particular concerns regarding the design and implementation of more efficient wheel slip prevention devices capable to avoid the above-mentioned phenomena with as small as possible reduction of braking capacity.

Another major problem is the friction between wheel and brake shoes, brake pads and disc respectively, which leads to severe thermal regimes and special thermal fatigue nature efforts, requiring specific constructive and operating standards.

More than that, due to the air compressibility and to the length of trains, the pneumatic commands propagates with limited speed in the brake pipe and, as a result, there always is a delay in the braking of neighboring vehicles. As a consequence, the rear vehicles are running into the front ones, producing large dynamic longitudinal reactions in buffers and couplers. The induced compression and tensile forces can reach significant levels, affecting both the rolling stock and the track, even conducting to deteriorations of safety operation of the trains.

Railway high speed operations also determined more severe requirements for braking systems, given to the necessity to develop higher braking forces and to dissipate larger amounts of energy in a short time, not to mention the problem of wear in the case friction brakes. In that case, complementary systems whose performance and reliability are safety relevant were developed to enhance the braking capacity.

These several issues, even briefly presented, reveal not only the importance and complexity of braking systems used for rail vehicles, but also the necessity of knowledge and understanding the problems in order to develop equipments increasingly more efficient and reliable.

Some of these aspects are presented in this chapter.

2. Classification of braking systems

Given the constructive, functional and operational characteristics of rolling stock, the braking systems must meet certain specific requirements, providing multiple performance exigencies. Some of the most important are then pointed out.

While achieving safe and effective brake actions to allow speed reductions, fixed-point stops and vehicle or train maintenance on slopes in complete safety, it is very important that brake operation and performance should not be influenced by environmental conditions.

A matter of great concern for the traffic safety requires for the braking systems that in cases of specific dangers to take action beyond the control or command of the driver and to perform an emergency braking action for all the train's vehicles.

Also, the centralized control of braking and release actions, as well as the transmission of braking commands along the whole train have to be simple, safe, effective and of maximum reliability. The braking systems have to allow adequate brake and release levels, giving the

driver the possibility to adopt and adapt correctly the braking force targets to the instantaneous traffic conditions. Moreover, transient phenomena developed during braking should not lead to high longitudinal dynamic forces in the body of the train that may affect the traffic safety. Still, the achievable braking forces should not affect the integrity of transported goods or the passengers comfort, neither due to decelerations and shocks along the train, nor by annoying vibrations and noises, bad odor, etc.

Regarding the construction of the braking systems components, especially those mounted under the vehicle chassis or on the bogie, they must have low mass and such sizes and shapes to fit the rolling stock gauge. By design, the mobile mechanical elements of the brake installation and mainly the brake riggings have to function correctly and optimally transmit forces, regardless of the fact that the vehicle is empty or loaded at maximum capacity and as long as the wear of all constructive elements of the vehicle are within the limits allowed by regulations.

The wear of friction elements used for achieving the necessary forces to decelerate or stop the train (brake blocks, pads, etc.) have to be as reduced as possible and their action must not affect the geometry of wheels or rails profile.

It is also very important that the thermal regime developed during braking to remain within acceptable limits, without affecting the braking capacity or other elements of the vehicle or of the track.

Last, but not least, commands, achievement and maintaining the effective braking actions must neither affect the environment, nor interact in any way with other systems, elements, and circuits of the track or situated in its vicinity.

An overall image over the braking systems for railway vehicles may be achieved following some classification criteria, as follows.

Depending on how the command actions are performed and according to the mean that braking forces are basically developed, there are:

- handbrakes, which are applied by hand action to a wheel or lever on the vehicle. Nowadays are generally used for securing unattended or unpowered vehicles against unplanned movement, not for braking actions while operating. That is why are usually known as parking brakes. Recent developments conducted to a kind of automation using a spring-applied concept, which release when compressed air for the basic pneumatic brakes is available. While such braking system is mandatory for traction vehicles and passenger carriages, only a part of wagons must be provided with it;
- pneumatic brakes, which use air pressure variations both to command and to apply the brake blocks or pads, generating braking/releasing actions and forces. The vast majority of trains use compressed air, changing the level of air pressure in the brake pipe determining a change in the state of the brake on each vehicle. In the case of straight air brake system, the increase of air pressure in the pipe determines the increase of air pressure in the brake cylinders of each vehicle. In the case of indirect air brake system, braking actions are commanded by decreasing the pressure in the train's pipe, generating by special features the increase of air pressure in the brake cylinders of each vehicle. In the same pneumatic category is also the vacuum brake system where the brakes on each vehicle are actuated by the action of atmospheric pressure over a specially created vacuum in the train's pipe as long as the brakes must be released;

- electro-pneumatic brakes, that have an electrical command while compressed air is used to increase the pressure in the brake cylinders of each vehicle to apply the brake blocks or pads for generating braking forces;
- rail (track) brakes, which are usually electric commanded and the braking force is achieved due to strong magnetic forces induced by large electromagnets hung under the vehicle's bogie, over the top surface of the rails. If the braking forces are generated by the frictional forces between the electromagnets and rails it is an electromagnetic rail brake. If the electromagnetic fields generate eddy currents in the rails, creating forces acting in the opposite direction of the movement of the train, it is a linear eddy current brake system. On the same principle is the rotary eddy currents brake system, the metallic mass being either the wheels, or discs attached to the wheelsets;
- electric braking, which is based on the reversibility of the electric engine, in particular the electric traction motors are reconnected in such a way that they act as generators which provide braking effort. Practically, the kinetic and/or the potential energy (while running on slopes) are converted into electric energy. If the power generated during braking is dissipated as heat through on-board resistors it is about a rheostatic braking. On electric railways, it is also possible to convert the energy of the train back into usable power by diverting the braking current into traction supply line, this being the case of regenerative braking. Most regenerative systems include on board resistors to allow also rheostatic braking if the traction supply system is not receptive, the choice being automatically selected by the traction control system. It is to notice that regarding the sustainable development of railway transportation, the regenerative braking is suitable for hybrid vehicles (Givoni et al., 2009; Uherek et al., 2010) and developments have been done for diesel powered traction rail vehicles;
- hydraulic brakes, which act using hydraulic oil and, depending on the achievement of braking forces, there may be hydrostatic, when is due to oil pressure increasing, or hydrodynamic when the kinetic energy of the vehicle is converted in the rotor of a hydraulic pump in heat which is dissipated through the oil cooling system.

Considering the effective way to achieve the braking force:

- friction brakes, based on Coulomb type friction between specific surfaces. It is the case of brake blocks (shoe brakes), disk brakes, electromagnetic rail brakes;
- dynamic brakes, based on other processes and phenomena than friction in achieving the braking forces. It is the case of eddy current, electric and hydrodynamic brakes. It is to notice that the electric eddy current brakes are particularly preferred for high speed railway vehicles because, in the absence of direct contact, it results a significant decrease of wear caused by friction, important aspect considering the high energy to be dissipated. For the same reason, the electric braking is also preferred in case of commuter trains, metros and tramways, due to the frequent and often quite strong braking actions, even if running speeds are usually not very high.

Considering the influence of wheel-rail adhesion, there are:

- adhesion-dependent brake systems, when the braking torque is generated directly on the wheelset. In these cases, whenever the braking force exceeds the adhesion one, either due to excessive braking, or to local poor adhesion between wheel and rail, will cause the wheel locking and skidding during braking. The main effects are an increase

in braking distances and the development of flats, damage spots on wheel tread, both affecting primarily the safety of traffic;

- adhesion-independent brake systems, usually used as complementary braking systems whenever the maximum braking forces developed by the adhesion-dependent ones is insufficient to provide the necessary braking capacity.

Regarding the brake system reaction in special cases, there are:

- automate brakes, meaning that in case of important accidental drop of air pressure in the brake pipe all the vehicles of the train are submitted to an emergency brake action, independent of driver control. Also, by the operation, a direct link of general pipeline to atmosphere can be established through an alarm signal put to reach of passengers in the coach;
- no automate brakes which, in similar situations, do not determine o brake command and even they can become inactive, unable to perform braking action.

According to the air pressure evolution within the brake cylinders, the compressed indirect air brake systems may be:

- fast-acting, meaning a filling time of 3...5 s and a releasing time of 15...20 s;
- slow-acting, meaning a filling time of 18...30 s and a releasing time of 45...60 s.

Depending on the possibility to modify the braking force level during the action, there are:

- moderable brakes, which can perform various braking steps during braking or/and releasing actions;
- unmoderable brakes, which can achieve a unique braking force level that cannot be modified by the driver and release is only complete, not gradual.

3. Basic braking systems

Basic braking systems provide consistent controllable braking forces on the entire traffic speed domain, permitting speed reductions, stop at fixed point and to maintain the vehicle standstill on slopes, usually being also automate.

Compressed air straight brake system is the simplest continuous brake, both in constructive and functional terms (see fig. 1).

The installation consists of a compressor (1) as source of air under pressure, a main reservoir for compressed air storage and backup container for the entire brake system (2), the general brake pipe of the train (3), consisting of the air pipes of each vehicle (3a), linked together by flexible coupled hoses (3b), each boasting angle cocks (3c) that acts as insulation. For the centralized command and control of braking it is a driver's brake valve (4) which must be able to put into effect at least three pneumatic functions: linking the main reservoir to the general air pipe of the train for supplying it; establishing the pneumatic link between the general air pipe and atmosphere; to be able to ensure the pneumatic insulation of the train general air pipe both to the main reservoir and atmosphere.

On each vehicle it is at least a brake cylinder (5), the forces developed at the piston rod (5a) being amplified and transmitted through the brake rigging (6) to the brake shoes (7) or disc pads.

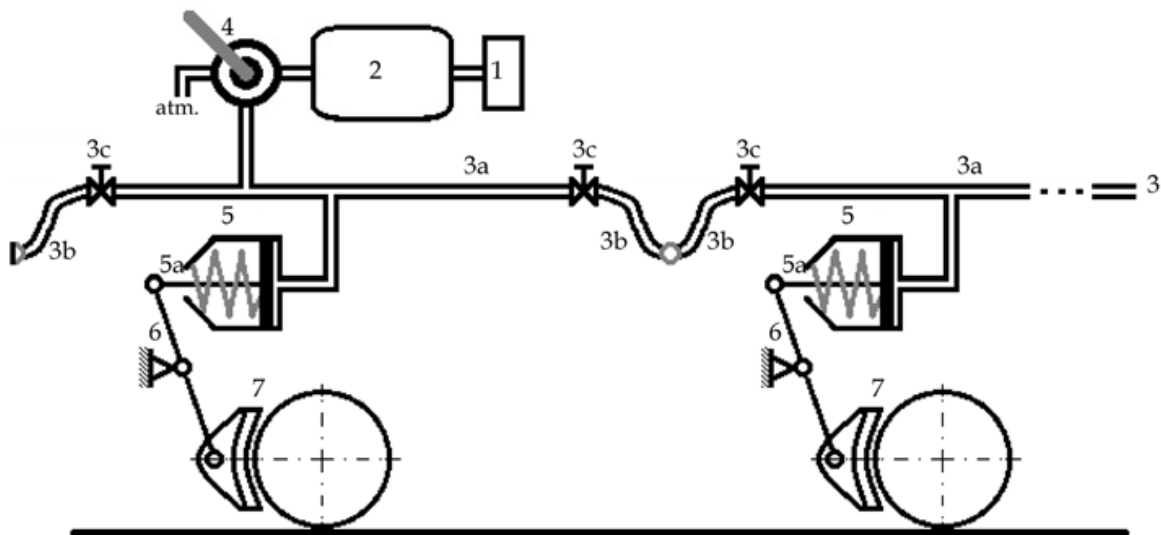

Fig. 1. Schematic of straight compressed air brake system:

1 - compressor; 2 - main reservoir; 3 - train's brake pipe; 3a - vehicle's brake pipe; 3b - flexible coupled hoses; 3c - angle cock; 4 - driver's brake valve; 5 - brake cylinder; 5a - piston rod; 6 - brake rigging; 7 - brake shoe.

The operating principle is simple: to control braking, the driver's brake valve connects the main reservoir to the general air pipe, which is supplied, implicitly increasing pressure in the brake cylinders. Brake cylinders act on the brake riggings, resulting in clamping shoes on wheels. When the train braking force is sufficient, through the driver's brake valve one stop any air supply to the general air train pipe. The system is very adaptive because, at least theoretically, by appropriate handling of the driver's brake valve it is possible to get a large range of pressure levels in the brake cylinders and, accordingly, to have a fine control of the commanded braking forces. For the control of brake release, through the driver's brake valve, pneumatic connection is established between the brake pipe and atmosphere, the air pressure coming from the brake cylinders including. By using the isolation position of the driver's brake valve, one can also get numerous release steps of the train brakes.

This type of braking control was quickly abandoned, the main reason being that a fault in the general pipeline leads to complete releasing of the brake without the driver to be warned in some way and without the possibility of restoring the action of the brakes, aspect particularly dangerous in terms of safety of the traffic.

In addition, the use of straight brake system involves a number of disadvantages, such as: a long duration of the braking propagation rate in the long of the train; high pressure differences between the brake cylinders in the transitional stages; development of large longitudinal reactions that may affect traffic safety and comfort of passengers because of slow braking wave propagation.

Also, the straight air brake system requires a large amount of compressed air when commanding braking action, which, in case of long trains, involves the use of large main reservoirs.

For these reasons, the straight air brake is now used on railway vehicles only as complementary brake for locomotives, railcars and some special vehicles. Even so,

according to regulations, straight brake can be used only for individual moving vehicles and not for a multi-vehicle train, when a much safer brake system must be used.

The indirect compressed air brake system was conceived in order to eliminate the main disadvantage of straight brake system. The main operational particularity is that brakes are released as long as in the train's brake pipe pressure is maintained the regime one. Generally, almost worldwide the regime pressure in the general air brake pipe system has been established at 5 bar (relative pressure). There are also exceptions, such as former Soviet countries, that use a regime pressure of 5.5 bar, or the USA where, depending on type of train, were imposed (by AAR - Association of American Railroads) 4.8 bar, 6.2 and 7.6 bar. Braking commands are given by lowering the pressure regime within the general air pipe of the train.

Indirect air brake is a continuous brake, basically having the same subsets, with identical functions as for straight brake (see fig. 2).

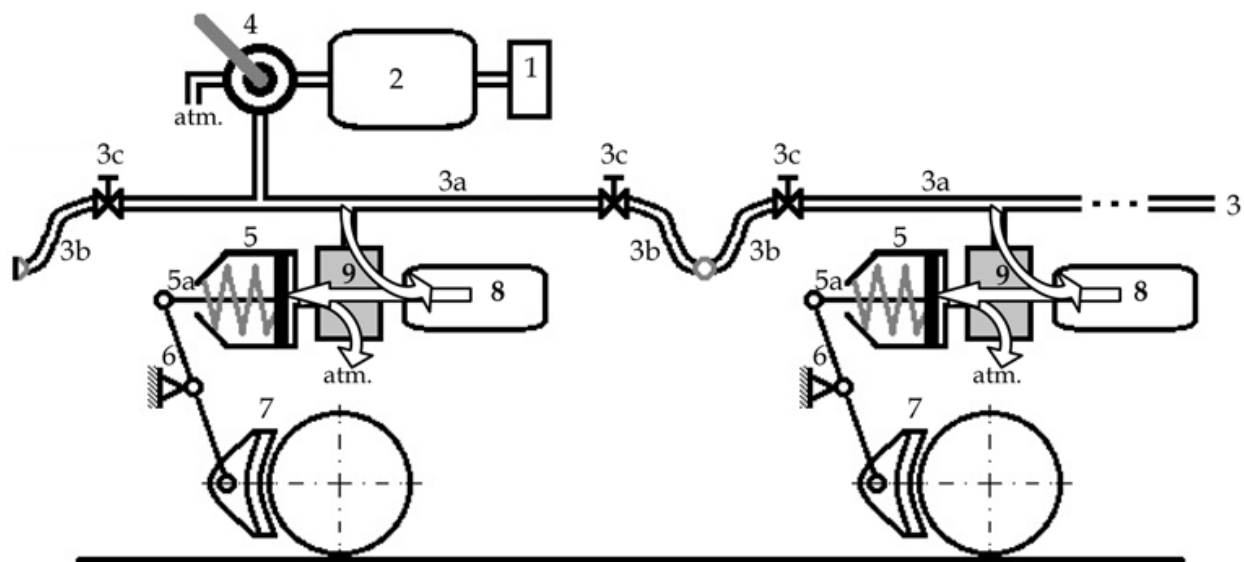

Fig. 2. Schematic of indirect (automate) compressed air brake system:

1 - compressor; 2 - main reservoir; 3 - train's brake pipe; 3a - vehicle's brake pipe; 3b - flexible coupled hoses; 3c - angle cock; 4 - driver's brake valve; 5 - brake cylinder; 5a - piston rod; 6 - brake rigging; 7 - brake shoe; 8 - auxiliary reservoir; 9 - air brake distributor.

In addition, each vehicle is equipped with an auxiliary air reservoir (8), which is the only compressed air supply reserve for the brake cylinders and an air distributor (9) that, depending on pressure variations within the brake pipe of the train, controls and commands locally the braking and release actions.

Air distributor may provide pneumatic links between brake pipe and auxiliary reservoir, between auxiliary reservoir and brake cylinder, and between brake cylinder and atmosphere.

To operate correctly, when increasing the general train brake pipe pressure, the air distributor should ensure the following pneumatic connections, in the specified order: interruption of the pneumatic link between auxiliary reservoir and brake cylinder, linking

the brake cylinder to the atmosphere and establishing a pneumatic link between the brake pipe and the auxiliary reservoir.

In the case of pressure drop in the general train pipe, the air brake distributor must first interrupt the pneumatic link between auxiliary reservoir and pipeline, then to cut the pneumatic link between air brake cylinder and atmosphere and finally to establish the pneumatic link between the auxiliary reservoir and the brake cylinder.

Air pressure in the brake cylinder depends on the brake pipe pressure according to UIC leaflet no. 540 requirements that impose the characteristic shown in fig. 3.

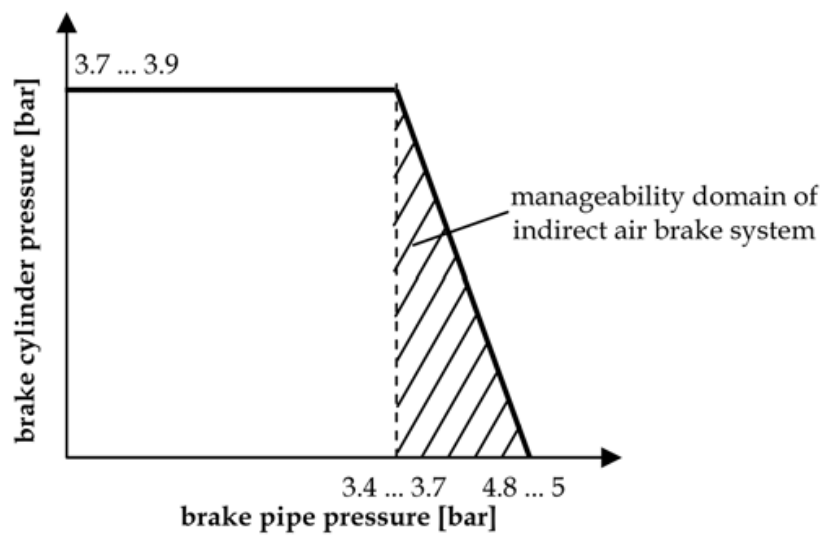

Fig. 3. Dependence of brake cylinder air pressure on brake pipe pressure.

It is noted that the manageability of this brake system is located between the values of 4.8 ... (3.4 ... 3.7) bar of relative air pressure in the general train pipe. Train driver can adjust the intensity of braking by controlling the pressure in the brake pipe between the above specified values. The maximum air pressure level in the brake cylinders is usually 3.8 ± 0.1 bar.

The main advantage of the indirect air brake is the safety on operation, due primarily to the operating principle that makes it an automate brake, meaning that any accidental important drop of air pressure in the general air pipe determines an emergency braking command for the entire train brake system, independent of driver control. Also, by the operation, one could be put to reach a simple and safe passenger braking control of the train for emergency situations by establishing a direct link of the general pipeline to atmosphere with an alarm signal. It is to notice that modern passenger trains are equipped with an emergency brake override system, to avoid stopping the train in inadequate places and situations which tend to be more dangerous than continuing the route, at least until the reach of a much safer location. An example, for instance, is in case of an on-board fire, while the train is running through long tunnels or viaducts.

The specific pneumatic command system is recognized as very reliable and simply constructive, the command and execution actions are provided by a single air pipe. Also, compared to straight compressed air brake, the indirect one presents several advantages,

including a significant increase of braking propagation rate along the train and, consequently, a decrease of dynamic in-train forces in the first stages of braking and releasing actions.

The main disadvantages of purely air brake systems rely on the transmission of the air signal which is initiated from the front of the train and has to be sent to all vehicles along the train to the rear. Due to the air compressibility and to the length of the train, there will always be a time lapse between the reaction of the leading vehicle and the reaction of one at the rear. Corresponding to the propagation rate of air pressure signal, the air distributors will come into action successively and the braking of vehicles begins at different times along the train so that, while some cars are slowing down, others are trying to push, still unbraked, from the rear. This creates conditions while transitional braking stages, immediately following the command of pressure variation in the brake pipe, to develop important longitudinal in-train reactions causing stress to the couplers and affecting passenger comfort and, sometimes, even the traffic safety. To mitigate such phenomena, it was necessary to achieve a certain delay of filling, respectively emptying the brake cylinders, accepting however an inevitable slight decrease in braking performance. That is why there are in operational use the fast-acting (or P, or type "travel") and slow-acting brakes (or G, or type "cargo").

The electro-pneumatic brake system is an improvement of the indirect compressed air brake destined primarily to overcome the longitudinal dynamic reactions generated by the gradually successive onset of brakes action due to the pneumatic command.

Basically, the electro-pneumatic system has been designed so that it can be added to the traditional air brake system to allow more rapid, practically instantaneous responses to the driver's braking commands (see fig. 4). As a consequence, vehicles were provided with braking electrovalves to evacuate the general brake pipe simultaneously along the train, according to the electric braking signal transmitted through the control wires running the length of the train. The pressure drop is present at the same time for each air distributor and the braking forces are developed simultaneously along the train. To perform the same for release commands, vehicles were also provided with electrovalves to supply the brake air pipe from a main air pipe which is directly connected to the main reservoir (8...10 bar), avoiding delays in releasing actions along the train.

Normally, the electrical control is additional to and superimposed upon the automatic air brake, although more recent systems incorporate a failsafe electrical control which eliminates the need for a separate brake pipe. Still, taking into account the safety of operating, international regulations impose that the electro-pneumatic brake must always be able to operate as a classical compressed air brake.

Usually, the braking commands are provided from the same driver's brake valve as the air brake, but using new positions to apply and release the electro-pneumatic brake. Electrical connections that are attached to the driver's brake valve send commands along the train to the electrovalves on each car. The electrical connections are added to the operating spindle so that movement of the handle can operate either brake system.

There are many types of electro-pneumatic brake systems in use today. There were developed systems that operate as a service brake while the air brake is retained for emergency use but with no compromise regarding the fail-safe or "vital" features of the air brake. Meanwhile, the main air pipe is also used for other auxiliary features, especially in the case of passenger vehicles: automatic door operation, supply of pneumatic suspension, etc.

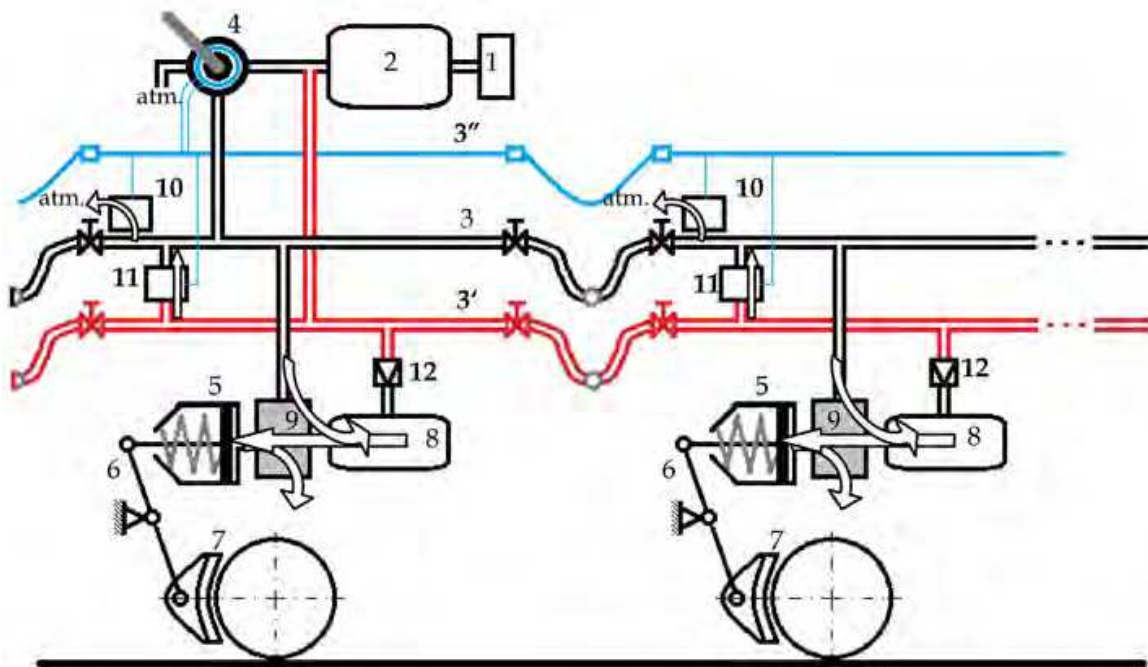

Fig. 4. Schematic of electro-pneumatic brake system: 1 – compressor; 2 – main reservoir; 3 – brake pipe; 3' – main reservoir pipe; 3'' – electric brake command; 4 – driver's brake valve; 5 – brake cylinder; 5a – piston rod; 6 – brake rigging; 7 – brake shoe; 8 – auxiliary reservoir; 9 – air distributor; 10 – braking vehicle's electrovalves; 11 – releasing vehicle's electrovalves; 12 – one-way valve.

The main technical issues relating to the operation and design parameters to be complied with electro-pneumatic brake in order to be admitted to equip rail vehicles are regulated by UIC leaflets no. 541-5, 541-6.

Even if the main advantage of the electro-pneumatic brake is the simultaneity in brake-release operation, extremely important in the case of long trains, as the freight ones, there are not many developments because of the diversity of wagons and the cost of conversion, not to mention that getting an electric signal to transmit at a low voltage down a very long train is difficult.

It is to notice that, due to the advantages, the electro-pneumatic brakes are largely used also in combination with other complementary braking systems such as the electric and the electromagnetic brake systems, for trams and metro trains, not to mention the high speed trains.

That is why the electro-pneumatic brakes equip mainly passenger vehicles and multiple unit passenger trains, the electric command being suitable for simultaneous on-board computer braking control of multiple braking systems usually in use.

At least in historic terms, among the basic brake systems, it is to mention the vacuum one, which constructively resembles with the straight compressed air brake (see fig. 5), having a vacuum pump instead the compressor.

It operates very simple, the brakes are released while the vacuum is maintained in the air pipe of the train and, implicitly, in the braking cylinders. The braking actions are

commanded by increasing the air pressure in the air pipe to the atmospheric pressure through the driver's tap.

It is to notice that, despite of the simplicity, it is an automate brake.

The main disadvantage determining its obsolescence is connected to the fact that the same braking force requires double diameter brake cylinder compared to the compressed air brake system. The system also raises operational problems related to air leakages detection.

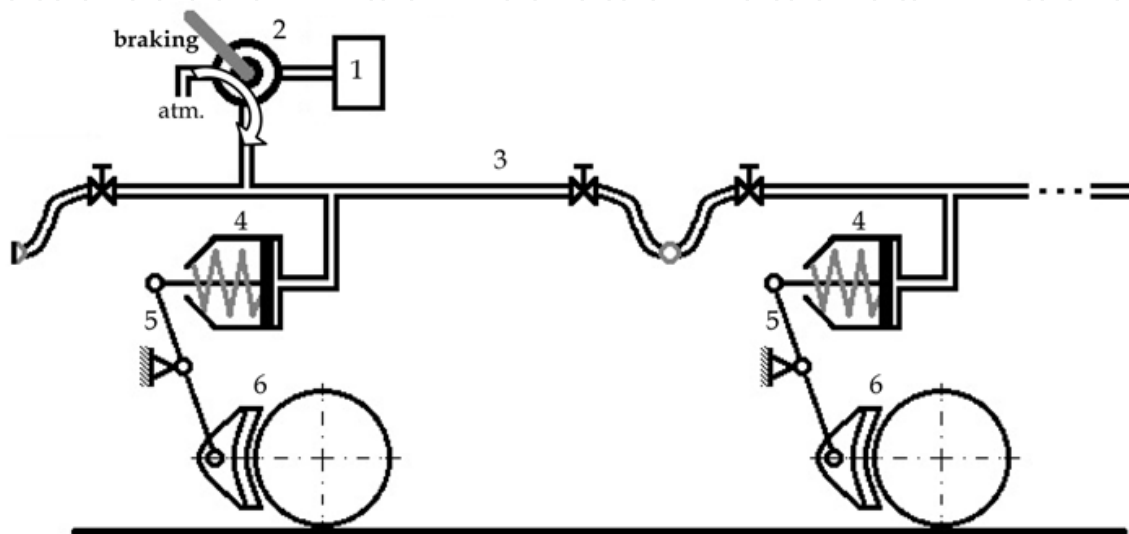

Fig. 5. Schematic of vacuum brake system: 1 - vacuum pump; 2 - driver's brake valve; 3 - general air pipe; 4 - brake cylinder; 5 - brake rigging; 6 - brake shoe.

4. Complementary braking systems

Generally the complementary braking systems provide consistent controllable braking forces permitting speed reductions but, unlike the basic ones, the braking efficiency decreases at low running speeds. As a consequence, there have to be used together with a basic braking system to ensure the capability of stopping at fixed point and of maintaining the vehicle standstill on slopes.

Complementary braking systems add braking power without having the thermal capacity limitations of the friction wheel or disc brakes that would necessitate expensive solutions or lead to excessive wear from harder use. More than that, those which are independent of wheel/rail adhesion improve safety by enabling shorter stopping distances when applied by giving a reduced dependency between stopping distance and adverse adhesion conditions caused by moisture, ice, leaves or other pollution on the top of the rails, etc.

That is why usually the decision to equip rail vehicles with complementary braking systems relies either on the incapacity of basic wheel-rail adhesion dependent brakes to ensure the braking necessary capacity for high speed trains and, in that case, there are necessary adhesion independent braking systems, or to diminish the wear of the friction based braking systems, in that case being useful the dynamic braking systems.

The magnetic rail brake operation is based on developing electromagnetic attractive forces towards the rail (see fig. 6), which causes a normal application force acting on their contact surfaces that are in relative displacement. This leads to friction forces between the magnetic brakes and rails, opposing the vehicle's direction of motion, which generate braking forces. The electromagnetic brake is used as additional wheel-rail adhesion independent braking system, generally associated to the brake disc.

There are two magnetic track brake positioned between the wheels on each side, normally mounted and attached to each bogie frame. The braking surface is of steel alloy or cast iron and is usually built up of sections with gaps between the sections and these are mounted to a sledge, which can be lowered from a parking position in the bogie. Using a rather low excitation power, about 1 kW/magnetic track brake, it is possible to obtain important application forces, about 50...70 kN and accordingly, for a normal vehicle installation (four axles coach), braking force per shoe between 4...10 kN.

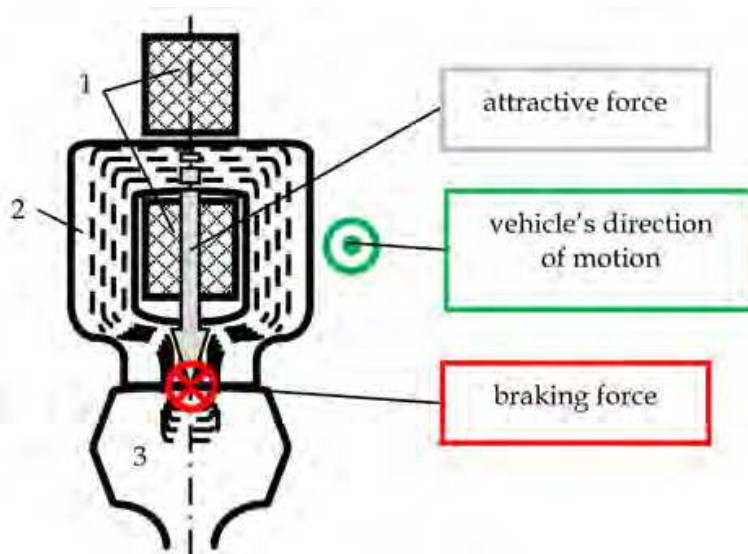

Fig. 6. Operating principle of magnetic rail brake system: 1 - coil; 2 - yoke; 3 - rail.

As stated, the main advantage of the system is the wheel/rail adhesion independence, important for the safety of operation by enhancing the braking power of classical basic braking system. Moreover, the friction between the braking surface and rail can sometimes significantly improve adhesion between wheel and rail due to vigorous cleaning of the tread rails during operation. As a result, for the classic braking systems is usually avoided the wheels slide even in adverse conditions. It is also to notice that given the mass of the magnetic rail brake assembly and its fastening system, the gravity center of the bogie is lowered, with positive dynamic effects for the vehicle, especially in high speed domain.

The main disadvantages are determined by the frictional operation of the system that lead to several drawbacks due not only to the relatively rapid wear of the braking surfaces especially for high traffic speed, but also to the increasing dependence of the shoe-track friction coefficient corresponding to the decrease of the running speed. As a consequence, the magnetic rail brake is designated only for emergency braking and is usually automatically released when the running speed is less than 50 km/h. This particular operation mode gives the complementary character of this system.

When designing the magnetic rail brake is important to consider also the interaction with the rails and generally with the track. Width and length of the magnetic brake shoe is critical in relation to the safe passage over the unguided area of switches and crossings, check/guard rails and other track design features or permanent way installations. On the other, the length is limited by the bogie wheel base, but the length of the braking surface must be kept equal to or above 1000 mm. Also, if too wide, parts of the frog can be hit outside the normal wheel-rail contact area or, in the extreme, fouling check rails. UIC leaflet no. 541-06 specifies the width of the friction plate to 65 – 72 mm, which is within the railhead width of UIC 46 to UIC 60 rails. The braking surface has to be flared at the ends in order to negotiate discontinuities in the rail head and the end elements of the brake shoes have both the characteristics of crossings with a tangent above or equal to 0.034 and the check rails. The general features of magnetic track brakes applicable to railway vehicles are stated in UIC leaflet no. 541-06.

The operating principle of the magnetic track brake by using a magnetic field may determine incompatibilities with train detection systems working on magnetic principles. Consequently it is advisable to be equipped with shields to reduce the adverse effects. Also, the friction operating may lead to abrasion of primarily shoe material, conducting to possible bridging of isolated rail joints for track circuits and to the formation of ridges on the shoe surface leading to reduced performance.

Because the magnetic track brake may develop high braking forces, one must not exceed an equivalent total deceleration of 2.5 m/s^2 over the train length, avoiding also excessive longitudinal track forces in track with low longitudinal resistance or prone to rail creep.

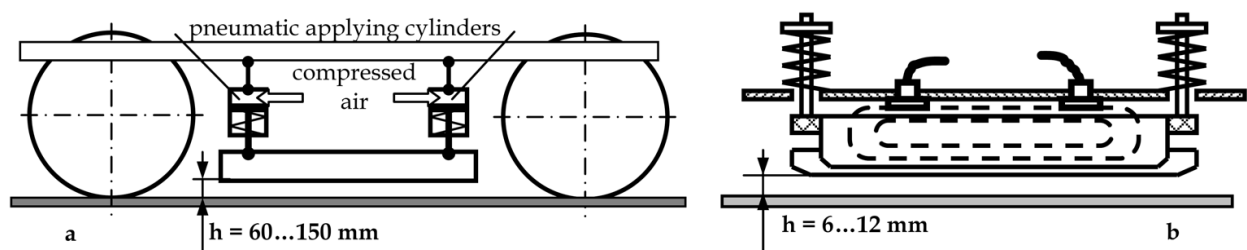

Fig. 7. Constructive solutions for magnetic track brake: a – high suspended; b – low suspended.

According to the maximum running speed, there are two constructive solutions (see fig. 7) regarding the release position: high suspended, with a distance between the braking surfaces and rails of 60...150 mm, common for running speeds exceeding 100 km/h and low suspended in the case of vehicles running up to 100 km/h, usually applied to tramways, the distance being 6...12 mm.

In the first case, pneumatic cylinders are used to descend the magnetic track brake up to the rails and only afterwards the electric circuits are activated. In the second case, due to the quite small air gap, the electromagnetic attraction forces are high enough to determine descending of the magnetic brake, too.

The eddy current brake system is a dynamic no mechanical contact one, based on the action of a magnetic field operating across an air gap between a set of electromagnets oriented successively N-S poles versus a metallic mass (see fig. 8). Consequently, it is a wear-free and

silent system, requiring minimal maintenance. Eddy currents are induced by movement in a magnetic field and the kinetic and, eventually, the potential energy of the train is absorbed by the metallic mass and converted into heat that dissipates in the environment.

Retardation depends on speed - the faster the train, the greater the braking force, on the intensity of the magnetic field and on the air gap. If the air gap is maintained constant, the braking force can be accurately controlled by regulation of the magnetic field while it is created using electromagnets fed from an external power supply, offering a useful solution as a frictionless moderable braking system for high speeds. Because the braking forces have a marked decrease at low running speeds, the eddy current brake is a complementary one and cannot be used for stopping at fixed points, nor as parking brake.

Depending on the element used as metallic mass, there are two constructive solutions: rail and rotary eddy current brake.

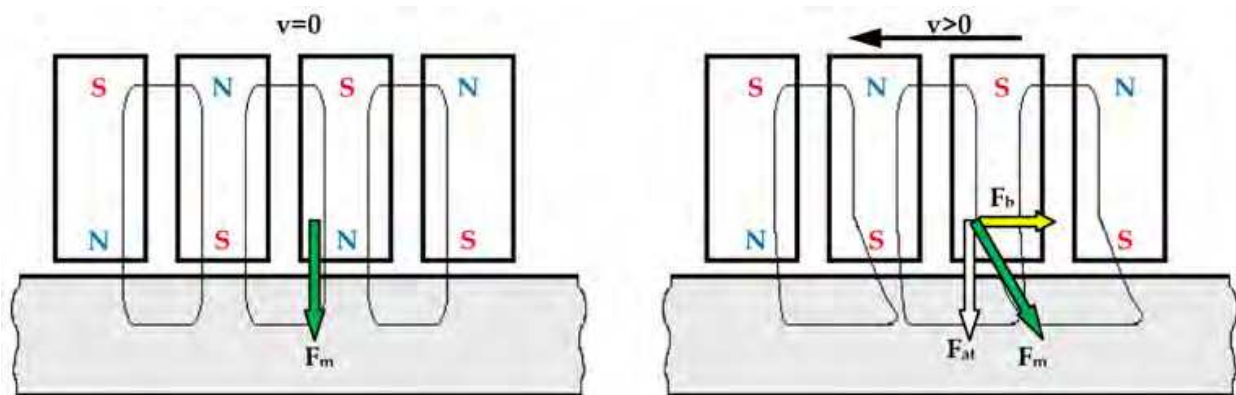

Fig. 8. Principle of eddy current brake system (F_m - magnetic force; F_{at} - attraction force; F_b - braking force).

In the case of rail brake, the braking electromagnets are disposed in a linear alignment with an alternating sequence of north and south poles, above each rail, apparently resembling to the rail electromagnetic brake. On each bogie, the magnet sets are connected through crossbeams to form a single assembly, which can be raised or lowered by a ring bellow. In order to prevent inadvertent mechanical contact between the solenoid coil housings and the track, damage to the magnet, or dampness leading to corrosion, the brake housing is fitted with an energy absorbing guard plate and sealed with a synthetic resin.

The main advantage of this system is the independence of wheel/rail adhesion, enhancing the braking power over the limits of classical basic disc brake usually associated with.

The rotary eddy current brake uses as metallic mass disks mounted on the axle or the wheels themselves, which rotate towards the electromagnets set in a housing and disposed also in alternating sequence of north and south poles (see fig. 9). The housing can be attached directly within the bogie frame, or can be supported on the wheelset, but in that case it must be secured against rotation. The first solution is simpler as design, but due to vertical and transversal relative displacements between the wheelsets and bogie frame one must achieve a large enough air gap, which consequently requires a higher excitation power. The second solution allows a smaller air gap, but the construction is more

complicated and expensive and determines an increase of the unsprung weight of the vehicle, particularly undesirable in the high speed domain.

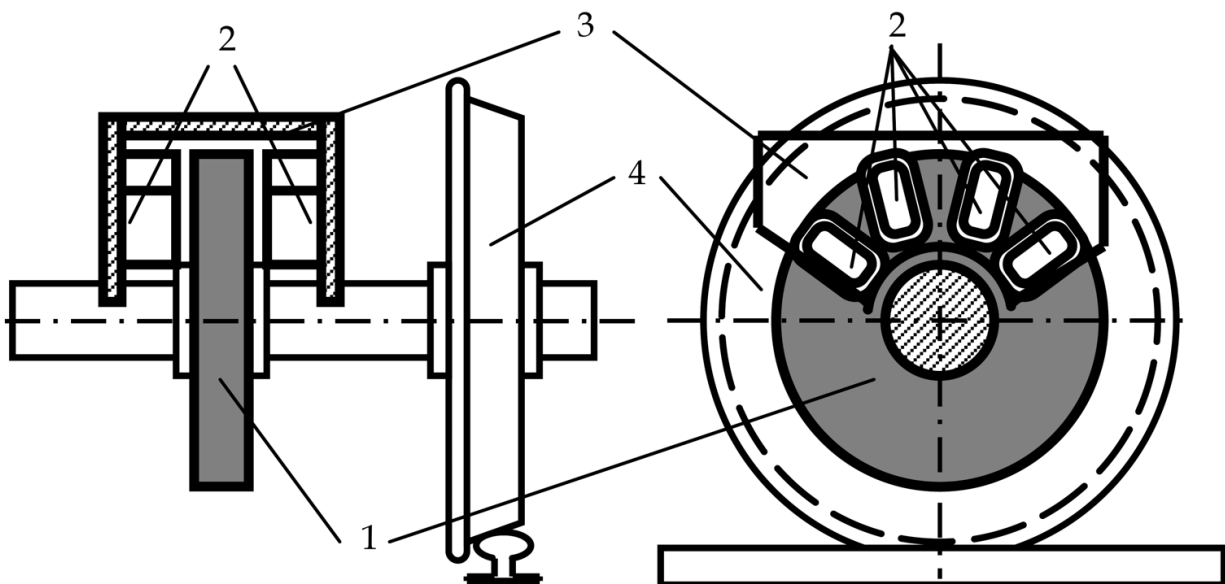

Fig. 9. Rotary eddy current brake: 1 - metallic disc; 2 - magnets; 3 - housing; 4 - wheel.

There are at least two major disadvantages of rotary eddy current brake. Due to the fact that the retarder couple is developed directly on the wheelset, it is an adhesion dependent brake and consequently unable to enhance the braking capacity of the mandatory basic system. The other is determined by thermal aspects, limitations being caused by the possibilities to dissipate the heat generated by the eddy currents in a relatively small mass, aspect enhanced due to specific aspects if the system operates on wheels.

Thermal aspects are certainly connected to the rail brake, but in case of a train, Sookawa et al. (1971), have shown that at 12 mm below the tread of the rail, in case of a 10 mm air gap, the rail temperature increase does not exceed 10°C. It is obvious that the temperature of the tread of the rail attains higher values, but it was found that in approximately 10...20 minutes the temperature evens within the rail mass (Pouillet, 1974; Sookawa et al., 1970, 1971), but normally, there do not seem to raise difficulties. In that case, the issue that had to be addressed is the heating of the rails as a result of repeated brake applications made in much the same locations, which is usual due to operational and signaling reasons. So, in the case of a high train frequency there is a potential risk that the rails will not be able to cool sufficiently between brake applications that may affect the track structure, turnouts and other critical elements such as bridges. Still, only periodicities of the sequences of trains braking in the same area less than 10 minutes might appear critical (Sookawa et al., 1970, 1971).

Regarding the air gap, independent recommendations are concordant. Studies and experiments conducted by Pouillet (1974) showed that the optimum value of air gap is 7...8 mm, while according to manufacturer Knorr-Bremse and DB's practical experience on the German ICE 3 train, the air gap between the magnets and the railhead should be between 6 and 7 mm when the brake assembly is lowered into its operating position (Schykowski, 2008).

Eddy-current brakes, especially the linear ones, seem ideally suited for high speed railways, improving rail safety by enabling shorter stopping distances and reduced dependency between stopping distance and wheel/rail adhesion, particularly during adverse adhesion conditions and offering braking power, both for service and emergency actions, which is difficult to achieve with other methods.

More than that, there are also other desirable effects in their use, such as mitigating the thermal capacity problems of brake pads and discs associated with conventional friction braking systems and avoiding harder application of conventional friction brakes leading to excessive wear of the pads and brake discs.

However, due to the operating principle, eddy current brakes raises issues of compatibility with infrastructure that can potentially impair both safety and technical reliability, meaning electromagnetic and physical compatibilities with train detection installations and line side equipment for train condition monitoring. It is also to mention that longitudinal, vertical and lateral supplementary forces induced by that braking system must fit the constructive track resistance.

5. Braking capacity

The main goal in designing and operating is to provide the necessary braking capacity appropriate to the type and specific running speed of the vehicles/trains according to the traffic safety.

Braking capacity is a significant feature of any railway vehicle and train which states the overall design and functional capability to stop from a maximum running speed according to the maximum braking forces developed during an emergency braking.

The braking capacity of a railway vehicle depends on numerous factors and some of the most important are: running speed, weight, type of brakes, constructive and functional characteristics of the brake rigging, braking characteristics, thermal phenomena, etc. In assessing the braking capacity of a train, additional parameters are involved: the train type, composition and length, the braking wave propagation characteristics, etc. Therefore, a direct and consistent assessment of braking capacity is difficult to achieve.

Specific for the railway vehicles, the possible maximum braking force is critical for the basic wheel/rail adhesion dependent braking systems. The main condition imposed is that braking forces at the wheel-rail contact surface $F_{b, \max}$ must not exceed the wheel-rail adhesion force F_a for designing purposes considered in normal conditions:

$$F_{b, \max} \leq F_a \quad (1)$$

Considering a vehicle having Q_v weight, relation (1) gets particular expressions for the case of being equipped with n brake shoes (see fig. 10, a):

$$F_{b, \max} = \sum_{i=1}^n (\mu_s \cdot P_{s,i}) \leq \mu_a \cdot Q_v \quad (2)$$

respectively with n brake discs (see fig. 10, b):

$$\frac{4 \cdot \mu_d \cdot r_m \cdot \sum_{i=1}^n P_{d,i}}{D_o} \leq \mu_a \cdot Q_v \quad (3)$$

where: μ_a is the wheel/rail adhesion coefficient, P_s and P_d are the clamping force on a brake shoe, respectively pad, μ_s and μ_d the friction coefficient between brake shoes and wheel tread and brake pad and disc respectively, D_o the wheel diameter and r_m the medium friction radius.

The braking forces are essentially influenced by the friction coefficients involved, their dependence on different parameters having important role on braking characteristics of the vehicle. There are many factors determining the evolution of friction coefficients, among them the most important proved to be the running speed, the clamping forces, the surface contact pressure and temperature.

Orientation towards a certain friction material for braking equipments is strongly influenced by the constructive and operational characteristics of the vehicle, mainly the maximum running speed, as well as by the dependence of friction coefficient on the previous specified parameters.

It is known that the friction coefficient between cast iron braking shoes and wheel tread strongly depends on the instantaneous running speed, the applying force on each shoe and the contact pressure, while the use of plastic (composite) materials for brake shoes or pads enables an independence of the friction coefficient on the mentioned parameters (see fig. 11).

In practical calculus, for the friction coefficient between cast iron brake shoes and wheel tread there are recommended different empirical relations, determined by experiments, depending on most important influencing factors, meaning mainly the running speed V [km/h], the applied forces on a break shoe P_s [kN] or the surface contact pressure p_s [N/mm²]. An example is UIC formula:

$$\mu_s(V, p_s) = 0.49 \cdot \frac{\frac{10}{35} \cdot V + 100}{3.6} \cdot \frac{\frac{875}{2860} \cdot p_s + 100}{g} \quad (4)$$

or Karvatzki formula:

$$\mu_s(V, P_s) = 0.6 \cdot \frac{V + 100}{5 \cdot V + 100} \cdot \frac{\frac{16}{86} \cdot P_s + 100}{g} \quad (5)$$

where $g = 9.81 \text{ m/s}^2$.

In the case of plastic brake shoes the friction coefficient is about 0.25, while for brake pads is about 0.35.

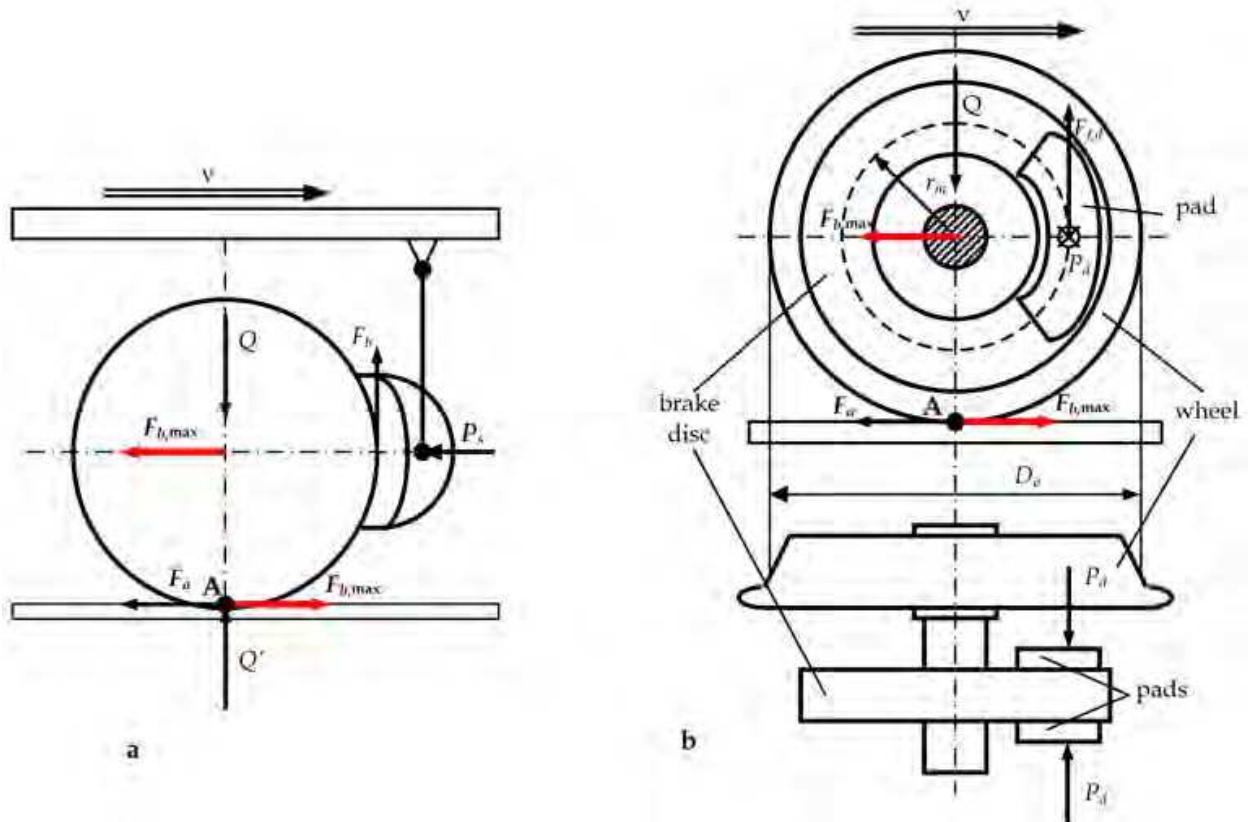

Fig. 10. Braking forces at wheel/rail limit adhesion: a - brake shoes, b - disc brake.

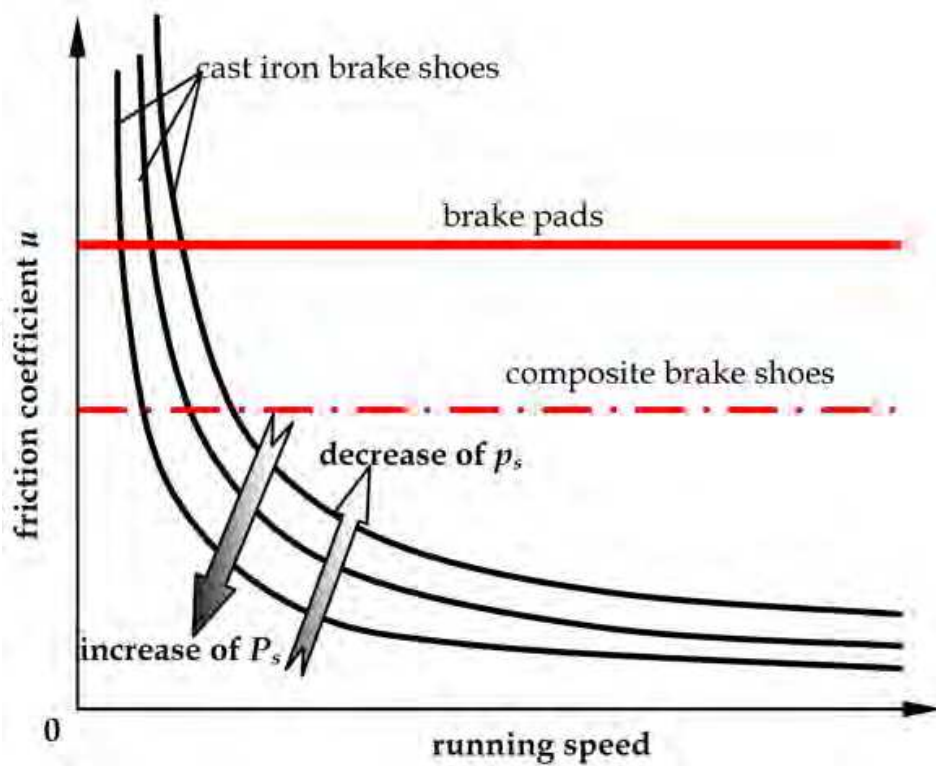

Fig. 11. Dependence of friction coefficient on running speed for different braking systems.

Due to the above mentioned independency on running speed and taking into account the high value (0.35) of the friction coefficient, according to international regulations, the disc brake is mandatory as basic brake system for vehicles running with 160 km/h or more.

Still the main problem is that friction interface between the brake pads and disc must not exceed temperatures of 350...375°C, else severe and sudden wear of pads occurs. Practically, the thermal regime determines the necessity of several brake discs mounted on the wheelset, even four in the case of high speed vehicles.

The vehicle mass is one of the factors influencing the necessary braking force, being proportional with the kinetic energy to dissipate during braking actions. When the vehicle's mass may have important variations, the braking forces have to be adjusted subsequently in order to avoid wheel slip and locking of wheelsets (for empty vehicle), unacceptable lengthening of the braking distance and enhancement of dynamic longitudinal in-train reactions. This issue is specific to freight wagons and some passenger cars, such as the double-decked, the post and/or luggage and those for transporting cars in passenger trains, characterized by a maximum possible load greater or comparable to the weight of the empty vehicle.

According to the type and constructive running speed there are two technical possibilities to solve the problem: either a step, or a self-adjusting load-proportional braking system. The first is used in the case of freight wagons with constructive running speeds less than 120 km/h, while the second is compulsory for passenger cars and freight wagons running with 120 km/h or more.

A step-adjusting load-proportional brake system has a manual or automatic empty-loaded control device which usually enables two clamping force levels on the friction elements (determining two braking forces) at the same pressure command of the driver, according to the size of the actual mass of the vehicle in relation to a switching mass.

The system requires either two amplification ratios of the brake rigging, or a classical brake rigging actuated by a double brake cylinder (see fig. 12).

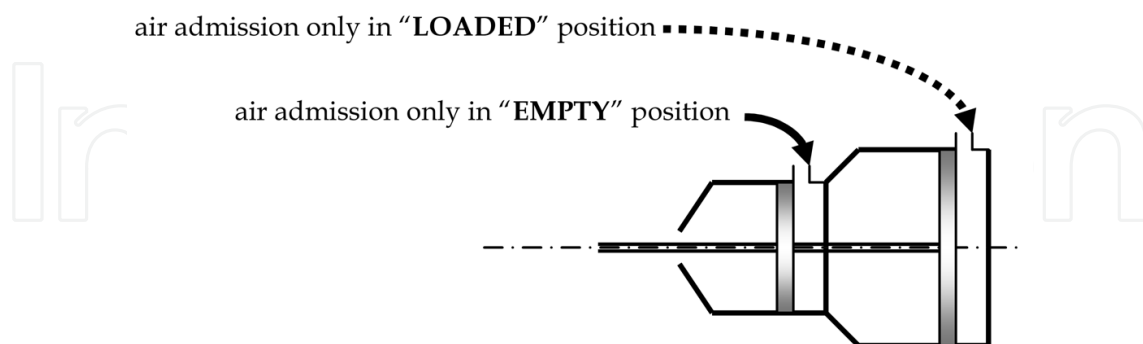

Fig. 12. Double brake cylinder.

The air pressure within the double brake cylinder is univocally determined by the air brake distributor, according to the driver's command in the brake pipe. Depending on the empty or loaded position of the device, the compressed air is directed to one of the segments of the brake cylinder. For the same air pressure, one may obtain two braking force levels, according to the diameter of the segment involved. The automatic empty-loaded control is

based on a mechanical or pneumatic determination of the suspended weight of the vehicle based on the deformation or size of the forces acting on the suspension springs.

The self-adjusting load-proportional braking system is capable of an accurate and continuous adaptation of the braking force to the weight of the vehicle. The system requires a weighing valve situated in the suspension and determining a command pressure which is sent to a pressure relay. This device operates together with the air distributor and adjusts the air pressure within the brake cylinders that is commanded through depression in the brake pipe of the train according to the command pressure proportional to the vehicle's load. That means that for the same braking command, the real pressure in the brake cylinders differs for different loads. Usually, taking into account an uneven distribution of load in the vehicle, there are at least two weighing valves placed diagonally in opposite sides and in the case of unique air distributor on the vehicle, a middle pressure valve is added to the system. Its role is to transmit to the pressure relay a mediated value of command pressures received from the weighing valves of the vehicle.

Very important is the brake cylinder pressure characteristic of the pressure relay. This shows the dependence between the maximum pressure within the brake cylinder and the weight of the vehicle and is determined based on the condition that, regardless of the load, the same braking distance to be achieved. The constraints are to respect the maximum 3.8 ± 0.1 bar pressure within the brake cylinder for maximum load and not to decrease below 1.1 ... 1.3 bar for the empty vehicle, in order to obtain a consistent braking force even for low braking steps.

The braking distance, usually defined as the distance covered by a vehicle or a train since the command of emergency braking from the maximum running speed, to a complete stop, is the minimum distance to stop using the full braking capacity available.

The braking distance seems to be extremely appropriate for designating the braking capacity, because it is direct effect of braking forces and all other implied factors, being measurable and permitting comparisons for evaluating the braking efficiency.

For an analytical determination of the braking distance of a rail vehicle it is important to take into account numerous factors, such as the running speed when the brakes are applied, the vehicle's weight, the evolution of braking forces dependent on the type, constructive and operational characteristics of the braking systems, resistances, the geography of the track, in particular slopes, etc. For trains, there are supplementary aspects involved depending on the length, the weight and even the mass distribution in the body of the train, the brake propagation rate, etc.

For accuracy, when theoretically determine the braking distance s_b there are considered first a "braking preparation space" s_p [m] covering the phenomena immediately subsequent acting the driver's brake valve until maximum pressure is established in all brake cylinders, continued by the effective braking space s_{ef} [m] covered with full braking capacity until stop:

$$s_b = s_p + s_{ef} \text{ [m]} \quad (6)$$

Generally for a single vehicle, or for a train in case of electric command supposed to propagate almost instantaneous along the train, the braking preparation space can be

calculated considering the pressure evolution during the filling time t_f [s] as a step function, at half of the duration the pressure becoming instantly maximum, determining beyond that moment the action of full brake capacity:

$$s_p = \kappa \cdot \frac{V_{\max} \cdot t_f}{3,6} \text{ [m]} \quad (7)$$

where V_{\max} [km/h] is the running speed at the moment of braking command and $\kappa = 0.5$. In the case of trains equipped with classical UIC air brake, the factor κ is recommended between 0.54...0.7 according to the length of the train and to the type of brakes.

Determination of effective braking space considering that the kinetic E_k and potential E_p (when running on slopes) energy of the vehicle/train are dissipated by the work of the braking and resistance forces. Because the rail vehicles have important masses in rotation, their rotation kinetic energy must not be neglected:

$$E_k = \frac{m \cdot v^2}{2} + \frac{I \cdot \omega^2}{2} = \frac{m \cdot v^2}{2} \cdot \left(1 + \frac{I}{m \cdot r^2}\right) = \frac{m \cdot v^2}{2} \cdot (1 + \rho) \quad (8)$$

considering v [m/s] the running speed, m [kg] the vehicle/train mass, I [kg.m²] the polar inertial moment of the wheelsets, r [m] the wheels radius and $\rho = I/(m \cdot r^2)$ a term accounting the rotational masses involved.

The potential energy depends on the track gradient i [mm/m] and on the travelled distance s [m]:

$$E_p = m \cdot g \cdot s \cdot \frac{i}{1000} \quad (9)$$

with $g = 9.81$ m/s². Obviously, on uphill track gradients gravity assists deceleration.

So, according to previously presented considerations, the braking effective distance s_{ef} may result from the equation:

$$(1 + \rho) \cdot \frac{m \cdot v_{\max}^2}{2} + m \cdot g \cdot s_{ef} \cdot \frac{i}{1000} = \int_0^{s_{ef}} F_b ds + \int_0^{s_{ef}} R ds \quad (10)$$

where $F_b = f(v, etc)$ [N] is the maximum instantaneous braking force and $R = f(v, v^2, etc)$ [N] the resistance forces.

As previously stated, the fundamental problem in establishing a train braking capacity is thus to determine the braking distance according to the maximum running speed. As shown, this would be a basic mechanics problem unless the implication of many nonlinear parameters such as brake propagation factor, the brake cylinder pressure evolution, the characteristics and multiple dependencies of the friction laws, the different and sometimes unpredictable composition of the train, etc.

Given the presented issues, to address current problems related to the safety of rolling stock operation regarding braking, it was necessary to define a general, synthetic term able to accurately quantify the braking capabilities not only for each railway vehicle, but also to enable a rapid, correct and adequate determination of braking capacities of trains, consistent to their composition, length and all other characteristic parameters.

That specific term is called braked mass, it is expressed in tons, constitutes a measure unit for braking effect and is compulsory to be inscribed on the vehicle. It has a general and synthetic character, it may be less than, equal to or greater than the mass of the vehicle and at present has no physically correspondent.

The term's designation is traditionally preserved from the time of freight trains using generalized hand brake, when the worst case that could meet during specific operating was locking of all wheelsets due to excessive action of the braking agents. Under these conditions, the maximum braking force $F_{b,max}$ [kN] depended only on the mass M [t], considering an relatively invariant friction coefficient τ between the locked wheels and the rolling tread of rails:

$$F_{b,max} = \tau \cdot M \cdot g \quad (11)$$

and hence the name of the term.

Currently, for determining the braked mass, there are taken into consideration not only the construction and operation of the brake equipments fitted to vehicles, but also the multitude of processes and phenomena that govern the braking action, such as: dependence of friction characteristics on instantaneous running speed, pressing forces, specific contact pressure; environmental conditions and their influence on friction coefficients as well as on the wheel/rail adhesion, being not allowed locking of wheelsets during the braking actions; specific pneumatic phenomena that determine the braking rate, the pressure characteristics of air distributors; influence of thermal phenomena and braking resultant heat dissipation; resistances of the vehicle/train, etc.

The value of braked mass consequently depends on many factors, processes and complex phenomena, which makes it extremely laborious and difficult to be established based on analytical calculation, accuracy to real braking actions proving essential given the importance on the safety of operation. Therefore, determining the braking mass of railway vehicles is mainly based on experiments and tests, but there are also relationships based on testing results fitted for some particular cases. Methodologies and procedures for determining the braked mass and are regulated by UIC leaflet no. 544-1. To be more convenient in practical use, it is also defined a specific notion, braked mass percentage ratio b , as the ratio between the braked mass B [t] and the train's or vehicle's mass M [t]:

$$b = \frac{B}{M} \cdot 100 [\%] \quad (12)$$

It is to notice that using the braked mass B or the braked mass percentage ratio b instead of brake space s to appreciate the braking capacity has a mechanical based justification.

Considering the simplest case of a train of mass M at a running speed v_0 subjected to a constant deceleration d , the braking space s and the stopping time t are related by known mechanical relationships:

$$s = \frac{1}{2} \cdot d \cdot t^2 \quad ; \quad v_0 = d \cdot t \quad \Rightarrow \quad s = \frac{v_0^2}{2 \cdot d} \quad (13)$$

The total braking force F_b of the train is proportional to the total normal applying forces acting the brake shoes on wheel tread or the brake pads against the discs $\sum P_N$:

$$F_b = \xi \cdot \sum P_N$$

The proportionality coefficient ξ might be $\xi = \mu_s$, the friction coefficient between brake shoes and wheels or, for the case of vehicles equipped with disc brake, $\xi = \frac{4 \cdot r_m}{D_o} \cdot \mu_d$ (μ_d the friction coefficient between brake pad and disc, D_o the wheel diameter and r_m the medium friction radius).

By definition, the braked mass is also proportional to the total normal applying forces:

$$B = \chi \cdot \sum P_N$$

The proportionality coefficient χ depends on the vehicle constructive and operational characteristics.

If neglecting the influence of other resistances and considering the definition of braked mass percentage ratio b given by eq. (12), then:

$$d = \frac{F_b}{M} = \frac{\xi \cdot \sum P_N}{M} = \frac{\xi}{\chi \cdot M} \cdot B = \frac{\xi}{\chi} \cdot b$$

and, taking into account (13), results:

$$s = \frac{v_0^2 \cdot \chi \cdot M}{2 \cdot \xi} \cdot \frac{1}{B} \quad (14)$$

and:

$$s = \frac{v_0^2 \cdot \chi}{2 \cdot \xi} \cdot \frac{1}{b} \quad (15)$$

Eq. (14) and (15) enhance the inverse proportionality between the braking space s and braked mass B , respectively the braked mass percentage ratio b .

6. Longitudinal dynamics of trains submitted to braking actions

As previous stated, according to international regulations, the indirect compressed air braking system is mandatory for railway vehicles because the pneumatic command is

recognized as very reliable and its automat functioning principle is very important for the safety on operation.

In the case of classical UIC brake system, due to the air compressibility and to the length of the train, there will always be a time lapse between the reaction of the leading vehicle and the reaction of the rear one. Corresponding to the propagation rate of air pressure signal, the air distributors will come into action successively and the braking of vehicles begins at different times along the train so that, while some cars are slowing down, others are trying to push, still unbraked, from the rear. This creates the conditions that during transitional braking stages, immediately following the command of pressure variation in the brake air pipe, to develop important longitudinal in train reactions causing stress to the couplers and affecting passenger comfort and, sometimes, even the traffic safety.

6.1 Trains braking phases

After a braking action command, speed begins to decrease due to the kinetic and potential energy dissipation mainly through the heat developed by the action of braking systems and through the work of the resistance forces that each vehicle and, accordingly, the whole train, are submitted to. These processes develop with different intensities in various places of the train assembly. So, in the case of a train equipped with standard pneumatic brake system:

- along the train, the effective action of the brakes begins successively, according to the length of the train and depending on the braking propagation rate wave, etc.
- at each vehicle, the braking forces increase up to the commanded value is time dependent, according to the filling characteristics specific to the brake and air distributor constructive and functional types;
- the train's vehicles can be equipped with various types of braking systems;
- usually, trains are composed with different types of vehicles and consequently the resistance forces differ, while the wheelsets and masses are not uniformly disposed along the train;
- vehicles may have various masses and loads and, depending on the type of brake devices that are fitted (basic, step-adjusting or self-adjusting load-proportional braking systems), braking forces will develop in different manners, finally being more or less adapted to the total weight of the vehicle;
- if for certain reason there are vehicles with inactive brakes, then even more the braked wheelsets are unevenly placed in the train body, etc.

From the above it follows that if taken separately each vehicle, according to its particular operating, constructive and loading features, it would stop on a specific braking space, even if submitted to the same braking action and beginning at same running speed. While connected in the train body, they will have to stop on a same distance, determining longitudinal reactions, certainly amplified by the specific operating mode of the indirect air brake system. These reactions that act on the shock and traction apparatus and are transmitted through the chassis, can be important under particular conditions, determining shocks and even affecting the safety of the traffic. These aspects must be studied in order to establish specific conditions in terms of braking features and train composition, as well as constructive and operational, to diminish the in-train dynamic reactions in such a manner to avoid disturbing or dangerous levels.

To easily understand the issues, Karvatski (1950) considered that during braking actions four phases occur and, to simplify the problems, he presented them under some assumptions, such as: masses and braked wheelsets are evenly distributed in the train body, assuming that vehicles are identically constructively and loaded and equipped with the same type of brake, all active and providing the same filling characteristics. Two typical cases are presented under these assumptions: a passenger train of 20 four-axles vehicles equipped with fast-acting brakes and a freight train of 100 two-axles vehicles equipped with slow-acting brakes. The time history of certain brake cylinders pressure, representing also proportional the evolution of brake forces along the trains, are presented in fig. 13.

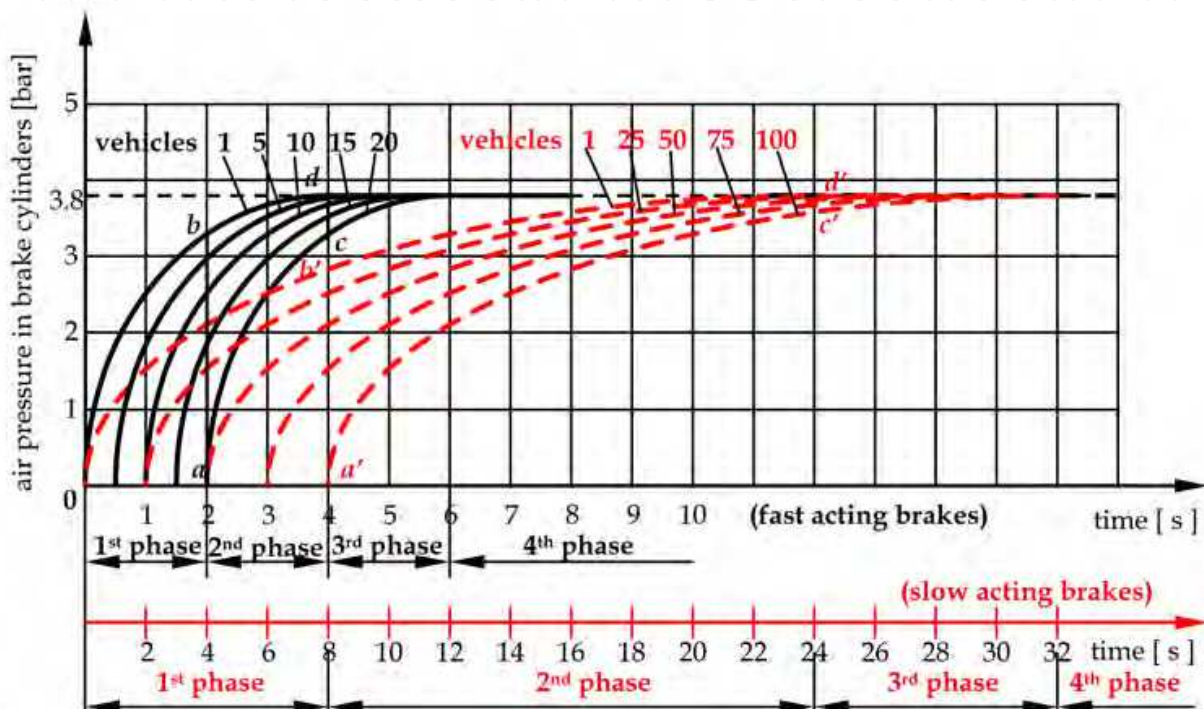

Fig. 13. Phases of train braking (continuous line for passenger train, dotted line for freight train).

The first phase is considered between the moment of commanding the brake action until the brake propagation ratio attains the last air distributor of the train. During that phase, the brakes begin to come into action successively along the train, which is submitted to a compression becoming maximum at the end of first phase, corresponding to the brake cylinder difference of pressures between the first and the last vehicle of the train (proportional to segments ab for passenger train equipped with fast-acting brakes, $a'b'$ for freight train equipped with slow-acting brakes).

The second phase is considered between the end of the previous one until in the brake cylinders of the first vehicle in train the maximum air pressure commanded is attained. During this time, pressure continues to increase uniformly in all the brake cylinders, maintaining a decreasing pressure distribution along the train, that remains consequently compressed, the compression level being similarly proportional to segments cd and $c'd'$ respectively. Moreover, under the assumed simplifying hypothesis, at the end of the first phase there are created all necessary condition to initiate an oscillatory motion, due to

inertial in excess forces in the second half of the train, which propagates along, pushing alternatively the vehicles from the front and the end of the train. The oscillatory motion, which overlaps on the existent compression of the train, is damped according to the damping coefficient of the buffers and traction gears.

The third phase lasts from the end of the second one until the maximum pressure is established in the brake cylinders of the last vehicle of the train. During this phase the maximum pressure is achieved successively in the brake cylinders along the train. As a result of successive braking forces equalization, the potential energy accumulated in the elastic elements of the buffers during the previous phases compressions is rendered to the system. Consequently it develops a "rebound" in succession along the train, its intensity depending on the damping characteristics of the shock apparatuses.

The fourth phase is considered between the end of the previous one until the train stops or a brake release command is performed. Because during that phase the maximum pressure already existent in all brake cylinders is maintained, braking forces remain constantly to their maximum values along the train, so the deformations stop and train length remain from now on unchanged.

It is to notice that even under the simplifying assumptions, the mechanical response of the train is extremely complex, the length of the train continuously modifies during the first braking phases and the overlap of oscillatory motion propagation determines the development of important compression and traction in-train forces. Incidents such as broken couplers during braking actions, observed mainly in the case of long, heavy freight trains submitted to braking actions, constituted the evidence of practice.

6.2 Mechanical model of the train

A classical approach for theoretical studies of the dynamic longitudinal forces developed during the braking actions along trains equipped with automated compressed-air brakes is a mechanical cascade-mass-point model in which vertical and lateral dynamics are usually neglected (Pugi et al., 2007; Zhuan, 2006; Zobory et al., 2000, etc).

Assuming that the train is composed of n vehicles, these are linked to each other by couplers, traditionally based on combined use of draw-gears and buffers. Consequently, the model is an elastic-damped lumped system consisting in n individual rigid masses m_i representing each vehicle, connected through elements having well defined elastic c_i and damping ρ_i characteristics (see fig. 14).

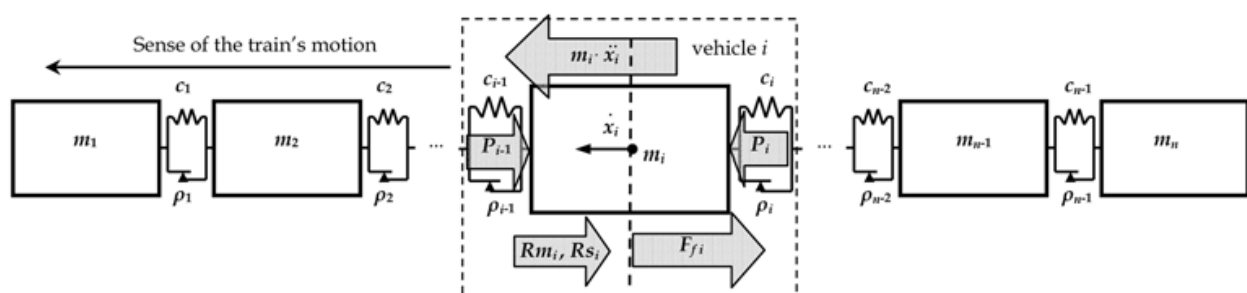

Fig. 14. Mechanical model of the train

Generally, a certain i vehicle of the train is mainly submitted to the following exterior forces: $F_{b,i}$ the instantaneous braking force of the vehicle, Rm_i the vehicle's main resistance, Rs_i the supplementary resistance due mainly to the tracking slope and curvature and P_{i-1} , P_i the in-train forces between the adjacent vehicles representing cumulated elastic and damping forces acting on the shock and traction apparatus between $i-1$ and i , i and $i+1$ respectively vehicles.

Considering x_i and \ddot{x}_i the position and the instantaneous acceleration of a certain i vehicle of the train submitted to the influence of the exterior forces, the equation of motion is:

$$m_i \cdot \ddot{x}_i = -F_{b,i} - R_i - P_{i-1} + P_i \quad (16)$$

for $i=1, 2, \dots, n$ and $P_0 = P_n = 0$.

Applied to all component vehicles of the train, eq. (16) constitutes a differential nonlinear equation system of second degree.

For each m_i vehicles' mass, the covered distance, the instantaneous speed and acceleration, as well as the instantaneous braking, resistances and longitudinal developed forces in the train's body are mathematically time dependent.

According to initial applied conditions, the equation system (16) can be solved applying a numerical integration process.

Generally, the main parameters influencing the assembly of the studied problem are: train's composition, number, mass and type of the vehicles, as well as their repartition in the body of the train; the braking system functional characteristics; the elastic and damping characteristics of the shock and traction devices; the evolution of the friction coefficient between the brake shoes and wheels, brake pads and discs respectively, eventually between the electromagnetic track brakes and rail, in accordance with the equipments of the train's vehicles.

6.3 Analysis of main mechanical parameters

For the case of disc brake equipped vehicle having individual self-adjusting brake rigging, the braking force can be calculated:

$$F_{b,i} = \left[\frac{\pi \cdot d_{bc}^2}{4} \cdot p_{bc,i} - (F_R + R_{sa}) \right] \cdot i_t \cdot n_{bc} \cdot \frac{2 \cdot r_m}{D_o} \cdot \mu_d \cdot \eta_{br} \quad (17)$$

where: d_{bc} is the brake cylinder diameter [m], $p_{bc,i}$ [N/m²] the instantaneous relative air pressure in the brake cylinder, F_R and R_{sa} [N] the resistance forces due to the brake cylinders back spring and to the self-adjusting mechanism incorporated in the piston rod respectively, D_o [m] the wheel diameter and r_m [m] the medium friction radius. The dimensionless terms are: i_t the brake rigging amplification ratio, n_{bc} the number of brake cylinders of the vehicle, μ_d the friction coefficient between brake pads and disc and η_{br} the mechanical efficiency of the brake rigging.

If the vehicle is equipped with shoe brake having symmetrical brake rigging with self-adjusting mechanism on the main brake bar, the braking force can be calculated by the relationship:

$$F_{b,i} = \left[\left(\frac{\pi \cdot d_{bc}^2}{4} \cdot p_{bc,i} - F_R \right) \cdot i_c - R_{sa} \right] \cdot i_l \cdot n_{\Delta} \cdot n_{bc} \cdot \mu_s(P_s, V_i) \cdot \eta_{br} \quad (18)$$

where d_{bc} [m], $p_{bc,i}$ [N/m²], F_R [N], R_{reg} [N] and η_{br} have the same significations previously assigned. The dimensionless terms are: i_c the central brake rigging, i_l the amplification ratio of the brake rigging's vertical levers, n_{Δ} the number of triangular axels and μ_s the friction coefficient between brake shoes and wheel tread which depends on the clamping force on each brake shoe P_s [kN] and on instantaneous running speed V_i [km/h].

Assuming that certain terms and factors representing constructive and functional characteristics are constant for the same vehicle during braking actions, one may be put in evidence that during the filling time the brake force for the brake disc is directly depending only on the instantaneous relative air pressure in the brake cylinder $F_{b,i} = f(p_{bc,i})$, while in the case of shoe brake, the dependence is more sophisticated due to the friction coefficient between brake shoes and wheel tread $F_{b,i} = f(p_{bc,i}, \mu_s(P_s, V_i))$.

In the last case, during the filling time, while the pressure in the brake cylinder increases and the clamping force P_s increase, the friction coefficient between brake shoes and wheel tread tends both to decrease due to P_s increase and to increase due to the running speed decrease (see fig. 11).

It is to highlight that the instantaneous pressure within the brake cylinder, main variable parameter, depends on several factors and some of the most important are: the pressure's evolution during the filling time of the air brake distributor; the precise moment of reaching the maximum pressure and its value within the brake cylinder, which from that moment, all along the braking action duration, can be considered constant, except the case if antiskid equipments action occurs; the characteristics of the first time duration of braking, defined as the time period of rapid increasing of the brake cylinder pressure, up to approximately 10% of the maximum admitted value. It is considered that only at the end of the first time duration of braking begins to develop an effective brake force for the vehicle.

Railway vehicles are linked each other by different kinds of couplers that must have certain elastic and damping characteristics, because they have remarkable influence not only for the protection of the vehicle's structure and the loading's integrity, but also for the passengers comfort. Generally, the traditional couplers wide used in Europe are composed of a pair of lateral buffers, a traction gear and a coupling apparatus at each extremity of the vehicle. Their characteristics have significant influences for the longitudinal dynamics of the train, with running stability implications. There are specific types of buffers for railway vehicles, their characteristics taking into account the requirements determined by mass, potential collision shocks and passengers comfort, etc. Therefore, there are different constructive solutions, using metallic, rubber, silicon type elastomers, hydraulic, pneumatic or hydro-pneumatic elastic elements.

According to the particular constructive and operational characteristics, the behaviour of buffer and draw-gear devices is quite complex due to several non linear phenomena like variable stiffness-damping, hysteretic properties, preloads of elastic elements, draw-gear compliance, clearance between the buffers discs, etc.

Buffers and draw-gears still widely equipping railway vehicles are based on metallic elastic rings (RINGFEDER type), using friction elements to fulfil the required damping effects.

The general characteristics of these devices mainly depend on the stroke Δx representing in fact the relative displacement between neighbor vehicles and on the relative velocity $\dot{\Delta x}$ and its sign (see fig. 15). The main parameters are: the stiffness $c_{i,j}$, the precompression forces $P_{oc,t}$, the length of the stroke defining the inflexion of the elastic characteristics $\Delta x_{2c,t}$ and the precompression of the elastic elements $\Delta x_{1c,t}$ of the shock and the draw-gear devices. The elastic characteristics $c^*_{i,j}$ might be determined either by experiment, or taking into account the damping depending on the accumulated and dissipated potential deformation energy, according to international regulations.

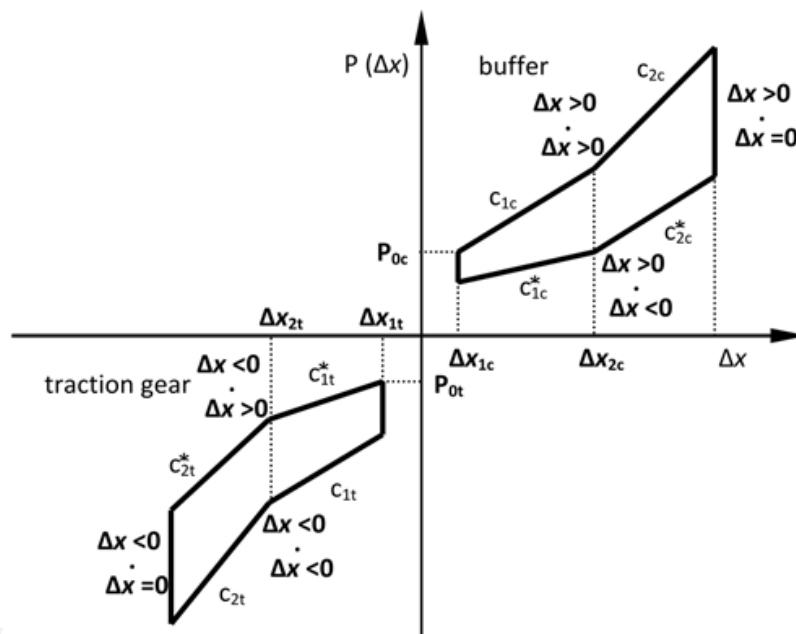

Fig. 15. General characteristics of shock (index c) and traction gear (index t) devices.

For freight wagons there are in use buffers with 75 mm elastic stroke, high capacity buffers with 105 mm stroke and high energy absorption capacity buffers with 130 and 150 mm stroke, while for coaches there are in use buffers with 110 mm stroke (prescriptions in UIC leaflets no. 526-1, 2, 3 and 528).

The resistances of trains and of each railway vehicle are determined by all forces that oppose to their movement. They depend on several factors among which the most important are the type and characteristics of rolling stock, running speed, the track characteristics (longitudinal and vertical profile), direction and intensity of the wind, etc.

Taking into account the divers causes and effects, usually there are considered two kinds of resistances. The main one summarizes all forces acting permanently whenever the

train/vehicle is moving in alignment on a horizontal track. The supplementary one are intermittent opposing forces, acting only at certain times and are determined by the circulation in curves, on ramps or slopes, by the wind action, etc. and they are added up algebraically to the main resistances whenever appropriate.

To simplify calculations it is common to use the specific resistances r [N/kN] defined as the ratio between the resistances R [N] and train/vehicle weight Q [kN]:

$$r = \frac{R}{Q} \quad (19)$$

Because the dependency on many factors, for calculate the specific resistance there are usually used empirical relations, established on experimental basis.

For studies regarding the longitudinal dynamics of trains it was previously stated that in-train reactions are mainly dependent on the instantaneous variation of longitudinal forces between vehicles. It is obvious that instantaneous running speed of each vehicle in the train body during braking phases are not absolutely identical, but differences can only be very small due to the permanent interconnection. Consequently, the instantaneous main resistances R_{n_i} differences are expected to be almost insignificant compared with braking forces $F_{b,i}$ during the brake stages. The same observation is for the supplementary resistances R_{s_i} as long as the train's vehicles are running altogether on the same track and are submitted to the same atmospheric conditions.

Under these conditions, for theoretical estimations of in-train longitudinal reactions evolution during braking actions, it is expected that results would not be significant altered if not considering the running resistances, all the more for almost similar vehicles. Still, eventually the air drag affecting the first vehicle may interest more.

6.4 Analysis of main pneumatic parameters

Generally the main cause of in-train forces is the instantaneous difference of the various longitudinal forces acting between vehicles. In the case of braking actions it is obvious that braking forces are most important and their time history in the first stages following the braking command is crucial.

While the mandatory basic braking system is the indirect compressed air one, the operation is very complex in order to meet the very demanding specifications to assure the safety and interoperability between different kinds of vehicles. As previously presented in § 3, the braking command is transmitted along the train as pressure reference and the braking system of every single vehicle interacts specifically with the complete pneumatic plant of the train.

That is why an adequate study of the pneumatic processes is important for such studies.

There are two important aspects influencing the longitudinal behaviour of the train submitted to braking actions: the moment when each air distributor begins to command the filling of the brake cylinders and the subsequent evolution of the air pressure in the brake cylinders. Accordingly, there are two different aspects that are usually emphasized: the propagation of braking signal along the brake pipe and the response of the distributor.

The air movement along the brake pipe and through the calibrated orifices, valves and channels of the distributors between the auxiliary reservoir and the brake cylinders is very complex and certain simplifying assumptions are usually considered and there are taken into account factors that have essential role in the evolution of processes.

For such pneumatic system, the main basic simplifying hypotheses are: unidirectional air flows (generally small flowing sections and quite long pneumatic elements make determinant the axial component of air speed and therefore a negligible variation of fluid properties in the normal section to flow direction); air is considered to be perfect gas (permits air status parameters correlation by Mendeleev-Clapeyron equation and is accepted the adiabatic exponent invariance); the flow of air in the pneumatic brake systems is accompanied by heat transfer phenomena between air, pneumatic enclosure walls and pipes and the environment.

Air flow modeling - as compressible fluid - in air brake systems is based mainly on the application of the laws of mass and angular momentum fluid (in a volume control) conservation and on the first two principles of thermodynamics. Also, the model must include the equation of state of fluid, which allows correlation of thermodynamic properties and, moreover, to consider, when appropriate, that movement of mechanical tasks is governed by the second Newtonian mechanics postulate.

Analyzing the evolution of processes consequently a braking command performed by establishing the pneumatic connection between the brake pipe and atmosphere through the driver's brake valve, Karvatski (1950) identified the following stages: the propagation of an air wave along the brake pipe, followed by a pressure drop determining the successive actuating of each air brake distributor according to its sensitivity and the subsequent pressure increase in the brake cylinders in compliance with the filling characteristics.

He explained the air wave propagation mechanism: once opened the pneumatic connection between the brake pipe and atmosphere through the driver's brake valve located at one end of the train, one generates and starts to propagate a stream of air to exit. The opening of the valve breaks down the overall balance of the air in the outlet vicinity and so, successively, the equilibrium of each air layer is broken while losing the support of the foregoing. The beginning of air movement at each point of the pipe determines consequently a beginning of pressure drop. This process is propagating with a certain speed w_{aw} [m/s] in the brake pipe to the other end of it:

$$w_{aw} = \sqrt{\frac{\chi \cdot p}{\rho}} \quad (20)$$

depending on the absolute air pressure p [N/m²], density ρ [kg/m³] and adiabatic exponent χ .

After the passage of the air wave, in each point of general pipe the air pressure begins to decrease, depending mainly on the brake pipe length l [m], on the distance between the driver's brake valve and the considered point l_x [m], on the air wave propagation speed w_{aw} [m/s] and the medium pressure drop totally generated Δp [N/m²].

Corresponding to his simplified model, Karvatzki (1950) determined the local pressure drop rate:

$$v_x = \frac{1}{2} \cdot \frac{\Delta p}{l} \cdot w_{aw} \cdot e^{-n \cdot \frac{l_x}{w_{aw}}} \quad (21)$$

where n is a logarithmic decrease factor showing the decrease of local pressure drop along the brake pipe, factor to be experimentally determined.

Analyzing the model, it appears that the main causes of the decrease of local pressure drop along the brake pipe are determined by the distributed pressure loss in the pipe and by the local pressure loss due to the air flow changes of directions. So, eq. (21) can be improved considering $n = 1$ and taking into account the pressure losses.

Distributed pressures losses occur whenever a fluid flows in a relatively long pipe having a comparatively small cross section, due to viscous friction between parallel layers of air, in this case.

The distributed pressure loss coefficient for a pipe of length l [m] and inner diameter d [m] is:

$$\xi_d = \lambda \cdot \frac{l}{d} \quad (22)$$

where λ is the coefficient of Darcy, determined experimentally according to the flow regime and the inner surface roughness or, for a laminar flow regime and smooth inner surface of the pipe, can be calculated using Poiseuille's relationship as a function of the Reynolds number Re :

$$\lambda = \frac{64}{Re} \quad (23)$$

For the case of a straight circular pipe, if laminar flow regime, the pressure loss between two flow sections situated at the distance l_d [m] along pipe can be calculated based on Hagen-Poiseuille relationship:

$$\Delta p_d = 32 \cdot \eta \cdot \frac{4 \cdot l_d}{\pi \cdot d^4} \cdot \frac{\overset{o}{m}}{\rho_{med}} \quad (24)$$

where $\overset{o}{m}$ [kg/s] is the air flow rate passing through the pipe and ρ_{med} [kg/m³], η [kg/m·s] the medium density, respectively dynamic viscosity of the air in given conditions. The temperature T [K] air viscosity dependence is:

$$\eta = \eta_o \cdot \frac{273.15 + C}{T + C} \cdot \left(\frac{T}{273.15} \right)^{\frac{3}{2}} \quad (25)$$

where $\eta_o = 17.09 \cdot 10^{-6}$ [kg/m·s] is the dynamic viscosity of air at 0° C, and C is Sutherland's constant $C = 112$ (for air).

Considering air as perfect gas and taking into account the constants values, eq. (23) becomes:

$$\Delta p_x \approx 0.017 \cdot \frac{l_x \cdot m \cdot T^{\frac{3}{2}}}{(T + 112) \cdot p_{med} \cdot d^4} \text{ [N/m}^2\text{]} \quad (26)$$

permitting an approximate evaluation of the distributed pressures losses at a l_x [m] distance from the driver's brake valve along the brake pipe.

The local pressure losses mainly manifest in the zone of flexible coupled hoses, their curvature that determines the air stream to change the flow direction affecting the braking wave propagation along the train's brake pipe.

Generally, the local pressure losses depend on the local pressure loss coefficient ξ_{loc} , on the air density ρ [kg/m³] and fluid velocity v_{air} [m/s] and can be determined with the relation:

$$\Delta p_{loc} = \frac{\xi_{loc} \cdot \rho \cdot v_{air}^2}{2} \quad (27)$$

In the case of a pair of flexible coupled hoses, considering the interior diameter d [m] and the curvature medium radius R [m], the local pressure loss coefficient can be calculated with relation:

$$\xi_{loc} = 0.131 + 0.163 \cdot \frac{d}{R} \quad (28)$$

The medium speed of air flow in the brake pipe of S [m²] interior cross section may be determined from the continuity equation, depending on the air flow rate passing through the pipe m [kg/s] and density ρ [kg/m³], resulting:

$$v_{med,air} = \frac{m}{S \cdot \rho} \quad (29)$$

Consequently, according to eq. (27), (28) and (29), considering the mean values of parameters involved, the local pressure losses for the "i" vehicle of the train are:

$$\Delta p_{loc,i} = (i-1) \cdot \frac{\left(0.131 + 0.163 \cdot \frac{d}{R}\right) \cdot m}{2 \cdot S} \quad (30)$$

On the other hand, air brake distributors are characterized by certain levels of sensitivity and insensitivity that determine the beginning of brake operation consequently to local pressure variation in the brake pipe.

Sensitivity can be defined as a minimum threshold pressure variation Δp_{sens} in the brake pipe determining the air distributor coming into action, meaning determining the fill of brake cylinders it commands. It is advisable a quite high sensitivity, so that the brakes easily

begin operate and to diminish both air consumption and duration of releasing actions. Air distributors take action only if the local pressure drop gradient v_{lim} permits, in a finite time t , to get:

$$\Delta p_{min} = \Delta p_{sens} < v_{lim} \cdot t \quad (31)$$

Still, because technically is difficult to maintain a perfect tightness of the brake pipe, it is not advisable for air distributors to be extremely sensitive, whereas the lowest random pressure drop may cause an unsolicited brake application. Therefore, it is also characteristic a certain insensitivity level, in the sense of a maximum local rate of pressure variation in the brake pipe which does not determine brakes to come into action. Thus, the brakes do not operate if the local pressure drop gradient has a sufficient low value in the vicinity of the air distributor so that:

$$\Delta p_{max} = \Delta p_{insens} > v_{lim} \cdot t|_{t \rightarrow \infty} \quad (32)$$

For determining the moment of operation start for the distributor of "i" vehicle situated at $l_{x,i}$ [m] distance from the drivers brake valve, the time elapsed since the braking command has been performed is:

$$t_{i,x} = t_{aw,x} + t_x + \Delta t_{d,x} + \Delta t_{loc,i} \quad (33)$$

In eq. (33), $t_{aw,x}$ [s] is the duration of air wave propagation up to the considered air distributor, t_x [s] the necessary time for air pressure drop to the sensitivity level in ideal conditions, $\Delta t_{d,x}$ and $\Delta t_{loc,i}$ [s] representing the time to compensate the distributed, respectively local pressure losses.

According to previously presented processes and correspondent equations, the moment of acting for each "i" vehicle air distributor, situated at $l_{x,i}$ distance from the drivers brake valve can be determined (Cruceanu, 2009):

$$t_{i,x} \approx \frac{l_{x,i}}{\sqrt{\frac{\chi \cdot p}{\rho}}} + \frac{2 \cdot l \cdot \frac{l_{x,i}}{w_{aw}}}{\Delta p \cdot w_{aw} \cdot e^{\frac{l_{x,i}}{w_{aw}}}} \cdot \left\{ \Delta p_{sens} + m \cdot \left[\frac{0.017 \cdot l_{x,i} \cdot T^{\frac{3}{2}}}{(T + 112) \cdot p_{med} \cdot d^4} + \frac{(i-1) \cdot \left(0.131 + 0.163 \cdot \frac{d}{R} \right)}{2 \cdot S} \right] \right\} \quad (34)$$

In particular, considering the adiabatic exponent for humid air $\chi = 1.405$, the interior diameter of the brake pipe $d = 25$ mm and the radius of flexible coupled hoses assembly between two successive vehicles $R = 1$ m, eq. (34) becomes:

$$t_{i,x} \approx \frac{l_{x,i}}{1.185 \cdot \sqrt{\frac{p}{\rho}}} + \frac{2 \cdot l \cdot \frac{l_{x,i}}{w_{aw}}}{\Delta p \cdot w_{aw} \cdot e^{\frac{l_{x,i}}{w_{aw}}}} \cdot \left\{ \Delta p_{sens} + m \cdot \left[\frac{0.017 \cdot l_{x,i} \cdot T^{\frac{3}{2}}}{(T + 112) \cdot p_{med} \cdot d^4} + (i-1) \cdot 96.3 \right] \right\} \quad (35)$$

As a numerical example, relation (35) was applied for the case of a passenger train composed of locomotive (20 m length) and 10 coaches (25 m length each), coupled through flexible hoses (0.5 m length each). The air distributors were considered placed at the middle of each vehicle. The initial relative pressure in the brake pipe was considered 5 bar (brakes released) and the necessary pressure variation in the brake pipe to determine the air distributor coming into action $\Delta p_{sens} = 0.3$ bar. It was considered an emergency braking action, the medium air flow rate evacuated from the brake pipe in first phases of the process being 0.7 kg/s. The main results are shown in fig. 16. For the particular case presented, the brakes of the last vehicle in train begin to operate 1.9 s after the brake command given from the drivers brake valve situated in the front of the locomotive (first vehicle of the train).

Even if the propagation of braking wave along the train seems to be almost linear, the relative time differences show that the propagation rate slows down along the train, as expected according to previously presented arguments.

The calculated medium propagation rate of the braking wave is in that case 245.5 m/s, respectively 266 m/s if considering as reference the moment when the first air distributor begins to supply the first brake cylinder. These values are consistent with the rigors of international regulations and with general evolution of the process within the brake pipe.

It is to notice that our model does not take into account the operation of emergency braking accelerators, so it represents the minimum propagation rate for the studied case. If the main purpose is to determine the maximum values of longitudinal dynamic reactions, then the use of the model conducts to estimates that cover the real processes. This affirmation is based on the fact that shorter the relative difference in time is, lower the braking forces differences between the train's vehicles are.

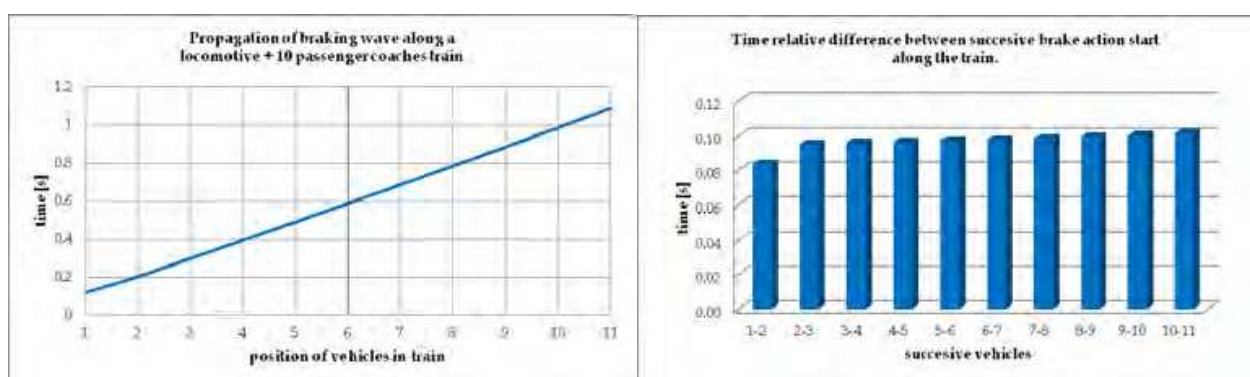

Fig. 16. Propagation of braking wave along the a short train (particular theoretical case study).

The other important target of pneumatic studies regarding the in-train forces developed during braking actions is the distributor valve, a complex pneumo-mechanic device which is devoted to control the brake response on every vehicle according to the air pressure variation in the brake pipe.

Due to the importance of the air brake distributors response to the pneumatic signals transmitted through the brake pipe, there were performed numerous theoretical and experimental studies regarding these aspects, based on more or less simplifying hypothesis,

all tending to highlight mainly the brake cylinders filling characteristics as accurate as possible (Belforte et al., 2008; Cantone et al., 2009; Piechowiak, 2010; Pugi et al., 2004, 2008, etc.).

Generally, the pneumatic behaviour of the air distributor may be modelled as a lumped system of chambers and orifices, but the influences of numerous mechanic elements (pistons, valves, springs, etc.) are also important and these are more difficult to integrate in a functional model. Still, the effect of the distributor is the brake cylinders filling characteristics which are mainly influenced by the nozzles that determine the filling (and releasing) time duration.

Under these conditions, a simpler way is to emphasize the role of calibrated orifices, considering them the main pneumatic resistance of the distributor. In that case, the air mass flow \dot{m} [kg/s] between the auxiliary reservoir and the brake cylinder may be determined considering in a first stage the nozzles as ideal convergent nozzles and affecting with a correction coefficient α_c that takes into account that in real circular cross section nozzles the minimum flow section is smaller than the geometric orifice section (see fig. 17) and pressure losses at the entrance lead to differences between actual and theoretical air flow speed through the calibrated orifice.

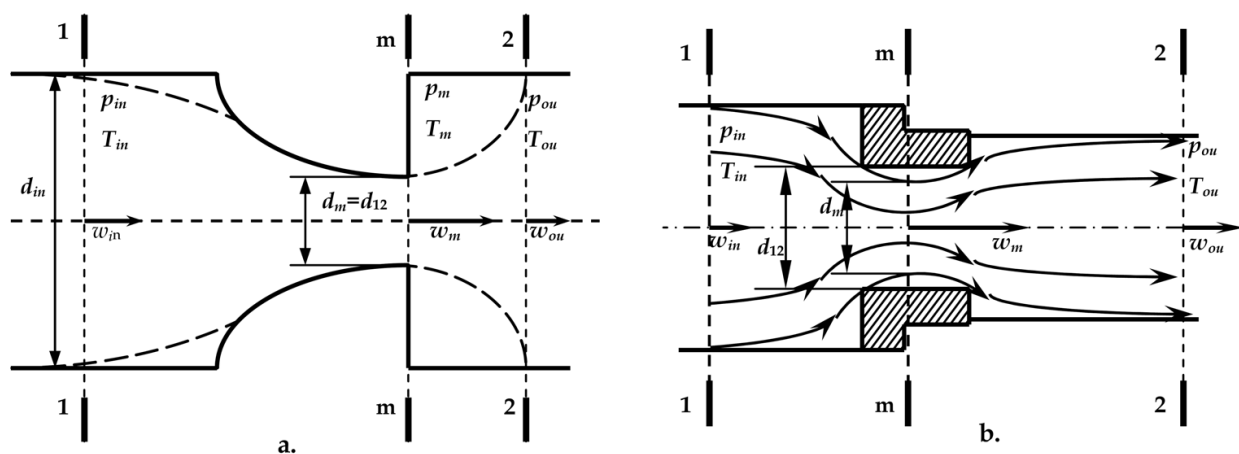

Fig. 17. Model of nozzle: a - ideal convergent nozzle; b - real circular calibrated orifice.

According to the air flow regime, the air mass flow can be determined for subsonic:

$$\dot{m}_{12} = \alpha_c \cdot \frac{\pi \cdot d_{12}^2 \cdot p_{in}}{\sqrt{T_{in}}} \cdot \sqrt{\frac{\chi}{8 \cdot R_a \cdot (\chi - 1)}} \cdot \left[\left(\frac{p_{ou}}{p_{in}} \right)^{\frac{2}{\chi}} - \left(\frac{p_{ou}}{p_{in}} \right)^{\frac{\chi+1}{\chi}} \right] \quad (36)$$

and for the supersonic one:

$$\dot{m}_{12} = \alpha_c \cdot \frac{\pi \cdot d_{12}^2 \cdot p_{in}}{\sqrt{T_{in}}} \cdot \sqrt{\frac{\chi}{16 \cdot R_a}} \cdot \left(\frac{2}{\chi + 1} \right)^{\frac{\chi}{\chi-1}} \quad (37)$$

where: d_{12} [m] is the minimum geometric diameter of the nozzle, p_{in} and p_{ou} [N/m²] is the air inlet, respectively outlet pressure, T_{in} [K] the inlet air absolute temperature, χ the adiabatic exponent, $R = 287.12$ [J/kg·K] the constant of the air.

The air flow regime can be appreciated comparing the outlet/inlet pressures rapport

according to the critical flow point $\beta_{cr} = \left(\frac{p_m}{p_{in}}\right)_{cr} = \left(\frac{2}{\chi + 1}\right)^{\frac{\chi}{\chi - 1}}$ as follows: if $\beta_{cr} < p_{ou}/p_{in} \leq 1$ than the flowing regime is subsonic and if $0 < p_e/p_{in} \leq \beta_{cr}$ is sonic (for equality) or supersonic, in both last cases the air mass flow is maximum possible in given conditions and can be determined using eq. (37).

Generally, eq. (36) and (37) are quite accurate according to the specific filling time imposed by regulations and can be used for initial dimensioning of diverse calibrated orifices used in the construction of various braking pneumatic devices for ensuring controlled pressure variations in certain pneumatic chambers. Still, when air flow is also mechanically controlled through valves actuated by pretensioned springs and commanded through the pressure acting on the piston, the air flow rate is certainly dependent on the opening height of the valve, too.

In the case of "normally open" valves (see fig. 18, a), the instantaneous opening height h depends on: the initial h_{max} opening, the stiffness c_s of the actuating spring, the diameter of the active surface of the valve's command piston d_p , the instantaneous relative air pressure p_c in the control chamber, on the initial valve spring prestressing force F_p :

$$h = h_{max} - \frac{\frac{\pi \cdot d_p}{4} \cdot p_c - F_p}{c_s} \tag{38}$$

For instance, in the particular situation of the maximum pressure valve that solely controls the pneumatic link between the auxiliary reservoir and the brake cylinder at emergency braking command in the case of KE air distributors, considering only the calibrated orifices, the theoretical filling characteristics determined using only eq. (36) and (37) are presented in fig. 18, b with continuous line. When considering the decrease of air flow ratio determined by the closing valve using also eq. (38), the filling characteristics become much closer to reality (dotted lines in fig. 18, b).

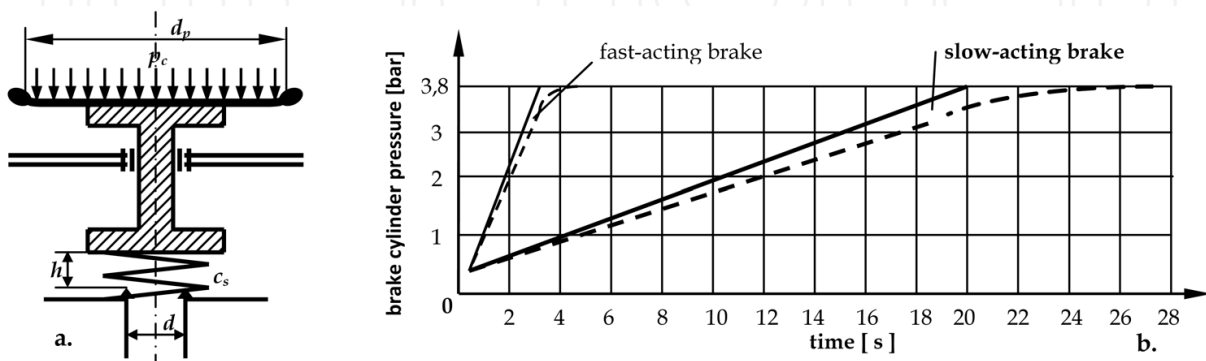

Fig. 18. Influence of valve opening on filling characteristics: a – schematic of pressure-spring controlled valve; b – theoretical filling characteristics (dotted line: valve controlled filling).

6.5 Longitudinal dynamic reactions in passenger trains submitted to braking actions

Studies regarding the longitudinal dynamics of trains during braking actions are mainly focused on long, heavy freight trains, due to the more obvious effects determined by the length of the brake pipe and numerous big masses interconnected (Belforte et al., 2008; Karvatski, 1950; Nasr & Mohammadi, 2010; ORE-Question B 36, 1972,1980; Pugi et al., 2007; Zhuan, 2006; etc).

Comparatively, issues regarding the longitudinal dynamic reactions in passenger train body seem to be less important. In fact, these are generally short, having a constant and much uniform composition than freight trains and there are sufficient arguments to support these assertions, e.g. passenger railcars are typically two axles bogies vehicles and have almost the same length, the mass difference between an empty and fully charged coach is significantly lower.

Still, there are arguments to prove not only the complex evolution of dynamic in-train reactions during braking actions, but also that there may exist circumstances in which these forces can become significant. Some relevant key features regarding braking actions in the case of passenger trains are highlighted below:

- running speed is significantly higher than in the case of long freight trains, so the energy dissipation gradient during braking is consequently greater;
- vehicles are mandatory equipped with fast acting air brake which, according to the admitted limits of filling time, determine an increasing pressure gradient in the brake cylinders of 0.7 - 1.2 bar/s, compared with 0.1 - 0.2 bar/s in case of slow action ones used in case of long freight trains. Consequently, during the first train braking phases, the instantaneous differences among braking forces become higher and are the premise of larger in-train forces;
- in the case of classical passenger trains, the locomotive weight is consistently larger compared to each passenger carriage, determining a pronounced nonlinear in-train body mass distribution: depending on train composition, the locomotive's mass may represent even 40...50 % of the whole train, constituting a large concentrated mass placed in a extremity. Therefore it is expected that longitudinal in-train dynamic reactions should be seriously influenced. More than that, it is an obvious tendency for train combinations in push-pull operations. In that case, the train can be driven either from the locomotive or the alternate cab. If the train is heading in the direction in which the locomotive of the train is facing, this is considered "pulling" and if the train is heading in the opposite direction, this is considered "pushing", the driver being located in the alternate cab. In that case, the longitudinal dynamics of the train deserves even greater attention not only in braking, but also in traction regimes, especially in pushing operations, when derailment risks are increased, mainly on switches;
- the random action of wheel slip prevention equipments, specific for passenger rail vehicles, may determine, in condition of poor wheel-rail adhesion, important and rapid braking forces variations between the train vehicles, increasing the dynamic longitudinal reactions;
- the action of the electromagnetic track brakes, as complementary system mandatory for running speeds exceeding 160 km/h, operating only in emergency braking actions, can induce supplementary longitudinal in-train forces in the case of non simultaneous releasing at the imposed running speed (see functioning principles in § 4);

- when using eddy current brakes, in particular the linear one, the air gap variation can determine random instantaneous brake forces variations between vehicles, determining an enhancement of longitudinal in-train reactions, etc.

It is also to highlight that in the case of passenger trains, the comfort is diminished during braking actions also due to the longitudinal shocks determined by the longitudinal in-train reactions.

At least these aspects conduct to the idea of studying the problem also for this type of trains. In order to determine the influence and effects of previously presented aspects, a team formed of members of the Rolling Stock Department from the Faculty of Transports of University *POLITEHNICA* of Bucharest developed certain theoretical studies regarding the longitudinal dynamic reactions for the case of passenger trains during braking actions (Cruceanu, 2009).

Dedicated software was created and numerical simulations for different case models were carried out in Matlab with the solver ode45, until numerical stability and reasonable results were reached, the relative tolerance of the solver being finally set to 10^{-9} (Cruceanu et al., 2009).

The mechanical model of the train is a classical elastic-damped lumped system according to § 6.2 and neglecting additional degrees of freedom due to bogies, suspension system, wheel-rail interaction, etc. This simplified our approach and was used to predict wagons and train compositions with the worst loading condition during the braking phases. In elaborating the general model, several initial simplifying assumptions were admitted, generally focused on considering that:

- vehicles are equipped with lateral buffers having a 110 mm stroke, according to UIC leaflet no. 528, constructively RINGFEDER type ones, meaning friction damping for these devices and the same for traction apparatus, according to UIC leaflet no. 520;
- the initial compressions of the elastic elements of the shock and traction devices were neglected;
- a tight coupling between the component vehicles, as regulated for passenger trains;
- an average steady braking wave propagation speed along the train of 250 m/s, the minimum imposed regulated value;
- exploitable braking forces develop only after reaching an approx. 0.4 bar pressure within the brake cylinder and once the pressure gets its maximum value, it remains constant during the whole braking process;
- the vehicles main resistances, which are mainly depending on the running speed, as well as the supplementary resistances, were neglected because during the braking process the relative instantaneous differences between the vehicles of the train are almost negligible in comparison with the other forces variations taken into account.

With the aim of obtaining accurate results, the conceived soft offers the possibility of using brake cylinders pressure information either directly from a complex computerized system for testing pneumatic braking equipment of rail vehicles, developed within the Scientific Research AMTRANS Program (2005/2008), or mathematical approximation functions.

For simulate diverse filling characteristics, based on the acquisitioned data (see fig. 19, a), it was first determined an interpolation polynomial function that approximates accurate

enough the air pressure evolution within the brake cylinder for the interest domain of $\Delta t = 2.86$ s:

$$p_{bc,3.16}(t) \approx -0.033 \cdot t^6 + 0.31 \cdot t^5 - 1.081 \cdot t^4 + 1.53 \cdot t^3 - 0.413 \cdot t^2 + 0.88 \cdot t + 0.4 \text{ [bar]} \quad (39)$$

This function was extrapolated for the case of 4 s and 5 s filling time (see also fig. 19, b):

$$p_{bc,4}(t) \approx -0.005 \cdot t^6 + 0.063 \cdot t^5 - 0.3 \cdot t^4 + 0.59 \cdot t^3 - 0.22 \cdot t^2 + 0.643 \cdot t + 0.4 \text{ [bar]} \quad (40)$$

$$p_{bc,5}(t) \approx -0.001 \cdot t^6 + 0.016 \cdot t^5 - 0.103 \cdot t^4 + 0.26 \cdot t^3 - 0.127 \cdot t^2 + 0.49 \cdot t + 0.4 \text{ [bar]} \quad (41)$$

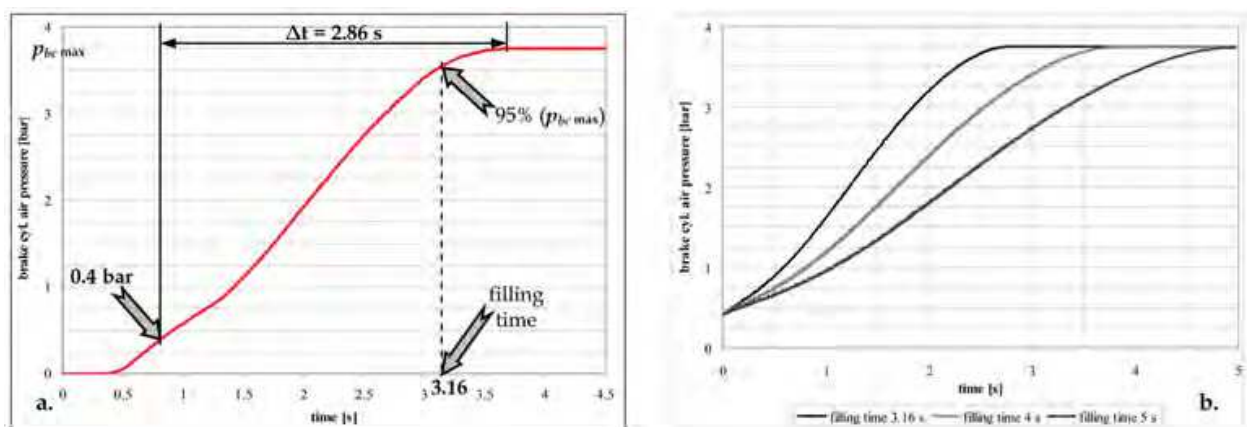

Fig. 19. Air distributor filling characteristics: a - experimentally determined; b - extrapolated functions.

The model for the shock and traction apparatus had to take into account the characteristics shown in fig. 15 which reveal the action of a friction force. Most commonly used is the Coulomb friction model which can be formulated as:

$$P = \begin{cases} F_c \cdot \text{sign}(v) & \text{if } v > 0 \\ F_{app} & \text{if } v = 0 \text{ and } F_{app} < F_c \end{cases} \quad (42)$$

where P is the friction force, $v = \dot{x}$ the relative speed and F_{app} the applied force on the body. F_c is the Coulomb sliding force classically defined as $F_c = \mu N$. Due to the properties of the sign function, these equations couldn't be used in the simulation because the numerical method proved to be unstable. A solution was to replace tanh function with signand so the new model became valid for any value of the speed v as shown in the following relation:

$$P = F_c \cdot \tanh(k_{\tanh} \cdot v) \quad (43)$$

where k_{\tanh} is a coefficient that determines how fast the tanh function changes from near -1 to near +1. Still, even if the model becomes more numerically stable, it has the disadvantage that assumes zero friction force at zero relative speed, meaning the acceptance that friction force exists only when there is a motion (Andersson et al., 2007).

More than that, as shown in fig. 15, the friction force in the shock and traction devices also depends on the applied force. This was taken into account considering that the Coulomb sliding force has the form:

$$F_c = \Delta c \cdot x \quad (44)$$

where x is the relative displacement between the cars and Δc is a constant which acts like a variation of the springs medium rigidity c_m . Finally, as the buffers and the traction apparatus have different rigidities, a ponder function p was used to modify the value of the force:

$$p = \tanh(k_{\tanh} \cdot x) \quad (45)$$

and the relation for the reactions between the cars, depending on the relative displacement x and velocity v is:

$$P = \frac{-[c_{mc} - \Delta c_c \cdot \tanh(k_{\tanh} \cdot v) \cdot x] \cdot (1 - p) + [c_{mt} + \Delta c_t \cdot \tanh(k_{\tanh} \cdot v) \cdot x] \cdot (1 + p)}{2} \quad (46)$$

The index c is for the buffers, while t is for the traction device. It was assumed that a negative value for x means that the apparatus is compressed (the force is given by the buffers) and a negative value of v means that the cars tend to come closer.

For example, studies were performed taking into account different passenger trains of 4...10 vehicles, for usual possibilities: train sets and classical trains with locomotive in pulling and pushing operations.

The passenger cars were considered having individual masses of 40...70 t, corresponding to usual weights for: coaches, dining, lounge, sleeping, baggage, etc. cars, double-decker included, in various in-train combinations, as for the locomotives, there were considered on four or six axles and counting on 80 and 120 t, respectively.

It was considered that trains are submitted to an emergency braking action started at a running speed of 180 km/h, being active only the classical UIC disc brake system.

It was considered that during braking action, no wheel slip prevention equipment operates.

There were considered only air distributors correctly operating and ensuring filling times between 3...5, as imposed by international regulations for fast-acting brake systems.

Some results of simulations are presented in fig. 20.

Relevant aspects regarding the longitudinal dynamic forces evolution for passenger trains submitted to braking actions emerged from the analysis of the results obtained based on simulations performed corresponding to previously mentioned cases are presented below. In order to appreciate the effects of different parameters, we referred mainly to the maximum compression, respectively traction in-forces, which have practical importance in offering an image of the maximum efforts the couplings are submitted.

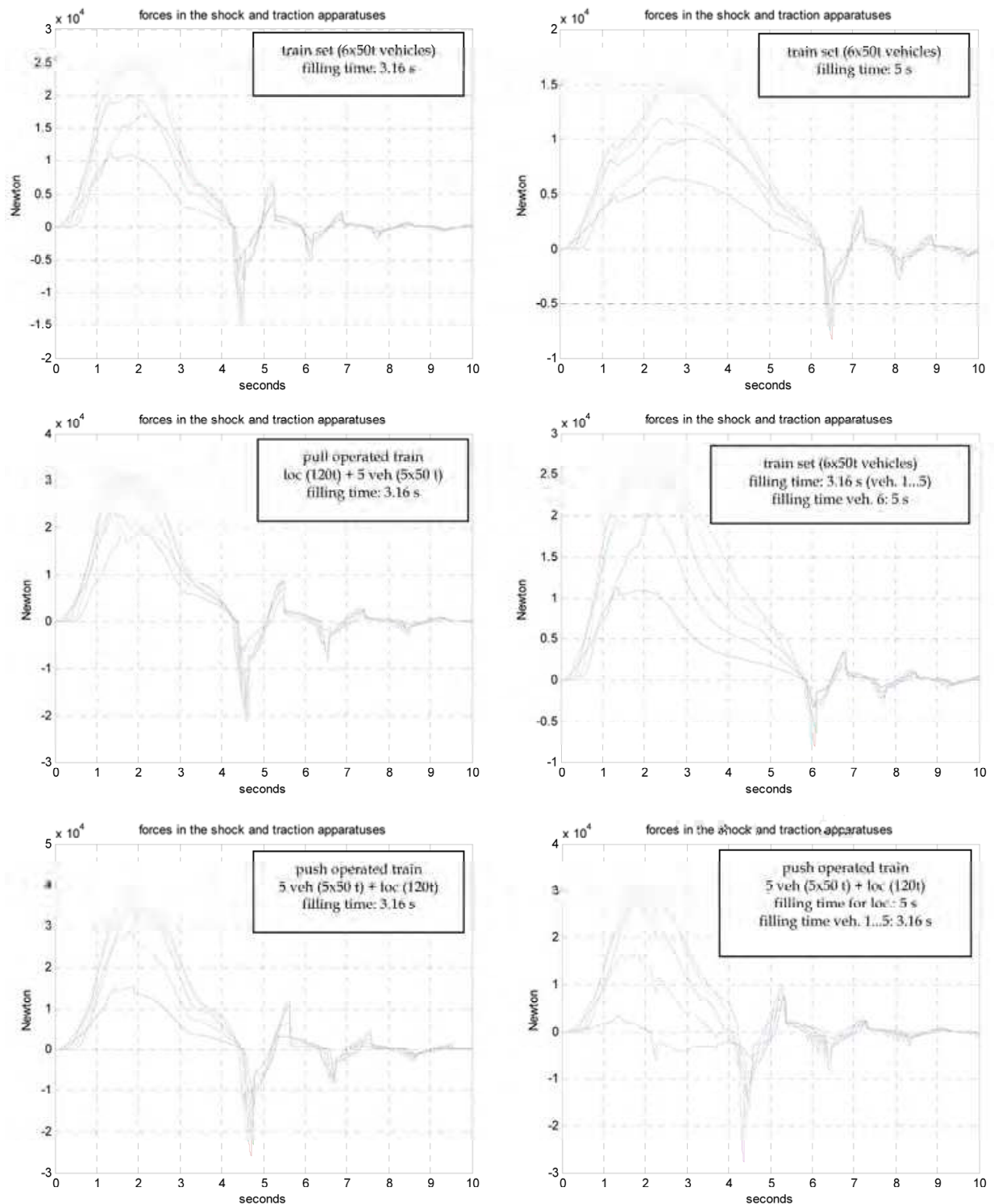

Fig. 20. Time-history of in-train longitudinal dynamic reactions between vehicles in passenger trains for different cases

So, the evolution of in-train reactions is concordant to the theoretical expectations, meaning that compression forces increase during the first braking phases, reaching a maximum value at the end of this phase, most of the times at about half of the train. In the second phase, these compression forces begin to decrease, while the braking forces are successively

increasing along the train. However, in concordance with the brake cylinder filling characteristic, the differences of instantaneous braking forces along the train begin to decrease. The forces in the buffers are therefore receding, varying slowly while the relative displacements remain almost constant. The process is more accentuated in the third phase when, while maximum braking forces are achieved along the train, tensile forces increase, the maximum value exerting most of the times also at about half of the train. During the last braking phase, though the braking forces are of the same magnitude along the train, a longitudinal oscillation movement of the vehicles begins and propagates along the train, due to the potential energy accumulated in the buffers during the train's compression. So, longitudinal forces continue their evolution, acting successively on the traction and shock apparatus. The amplitude of this wave decreases due to the energy dissipation corresponding to the friction forces acting in the buffers and the traction devices.

A remarkable feature of the oscillations period is the fact that about a half of a complete cycle is characterized by considerably larger forces than the other half (see fig. 20). The reason is that when the relative displacement is negative, the stiffness of the shock and traction devices is considerably greater than the opposite situation. The friction forces increase or decrease their value, depending on the sign of the relative speed. In consequence, each cycle has a "sharp" part and a "soft" one, as a result of the combination of friction forces and variable rigidities.

It is also interesting to note that in the simulations there appear, more or, sometimes, less evident, but visible in the presented diagrams (see fig. 20), the oscillatory motion that propagates in the train, overlapping on the preexistent compression after the end of the first braking phase.

Regarding the influence of brake cylinders filling time, the first observation is that generally, higher the pressure increase gradient is, both maximum compression and traction in-train forces increase. For the cases of same filling times for each vehicle of the train, the maximum longitudinal dynamic forces diminish their magnitude in average about 24..43% while increasing the filling time from 3.16 s to 4, respectively 5 s. However, the disposition of the maximum forces remains almost the same along the train. The situation changes if the vehicles of the same train are characterized by different filling times. In that case, the magnitude of the dynamic longitudinal reactions and their layout along the train strongly depends on the position and filling time of each vehicle within the train. Longer filling times, wherever placed in the braked train, diminish the traction longitudinal dynamic forces. This assertion is also correct regarding the compression forces, but only if the vehicles having longer brake cylinders filling times are placed in the first half of the train. Otherwise, the longitudinal compression dynamic forces increase, the maximum values being attempted between the vehicles situated in the second part of the train. Anywise, at least for the studied case, in spite of the almost spectacular forces evolutions due to different filling times, their magnitude can not affect severely the shock, traction and coupling apparatuses.

Regarding the vehicles mass and length of the train, in case of uniform composition, the increase of both parameters determine higher dynamic reactions, both for compression and traction forces, maximal values exerting mainly between vehicles situated in the middle of the train. It is to notice that the evolution and distribution of in-forces along the train are similar, indifferent the masses of the identical vehicles are.

The dynamic longitudinal reactions have an almost linear dependence on the mass of the component vehicles in the considered train set. The maximum traction forces are always lower than the correspondent compression forces, in similar conditions. Still, they have a more considerable relative increase in respect to the relative growth of the vehicles mass.

For uneven composition of the train, important variations of the dynamic compression and traction reactions occur, both as magnitude and distribution among the vehicles along the train.

In the case of classical trains, the evolution and the distribution of longitudinal dynamic forces along the train are almost similar to train-sets for the middle part of the train. Still, in the extremities, a heavier locomotive (120 t) determines higher values between the front vehicles, while a lighter one (80 t) conducts to an increase of these reactions between the rear vehicles. In the case of push-operated trains, the maximum longitudinal forces are generally higher and their distribution between the vehicles is substantially modified. Forces become more important in the second part of the train.

An interesting and useful approach in analyzing the influences of various parameters on the dynamic longitudinal reactions between the vehicles of passenger trains submitted to braking actions is based on relative percentage forces variation.

For example, studying the compression and traction forces exerted in the couplers of three types of six vehicle trains (train-set, train in "pulling" and in "pushing" operation with 120 t locomotive) by reporting to the simulation results to the case of the train-set, the repartition and modification of maximum reactions in the train body become more obvious, enhancing the effects (see fig. 21).

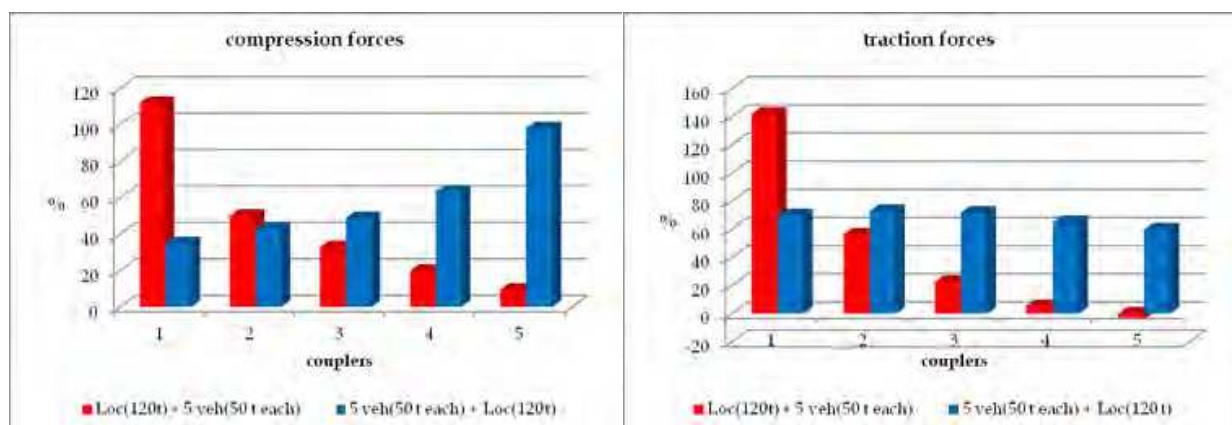

Fig. 21. Relative evolution of maximum longitudinal dynamic forces in braking actions in "pulling" and "pushing" operations reported to similar train-set

Such relative approaches indicate more clearly the important increase of in-train forces in the vicinity of the locomotive, having larger mass than the rest of the train's vehicles. Also, even if in absolute values the maximum traction forces are lower than the compression ones, their relative increase in the case of classical trains is much higher for heavier locomotive in pull operation.

It is thus obvious that the dynamic longitudinal response of passenger trains submitted to braking actions is very complex and the magnitude and distribution of compression and traction in-train forces are strongly influenced by the type, composition and mass

distribution along the train. Also, the functional characteristics of the braking devices, mainly the air distributors, determine specific reactions, which are all the more influenced by their repartition in the body of the train.

Specific parameters may enhance the dynamic longitudinal reactions between the vehicles of passenger trains, either in the train assembly, or in particular sections. Results of studies regarding these problems may conduct to interesting and useful recommendations for designers and manufacturers of vehicles for passengers and not the least for the operating staff, both in terms of composition and driving passenger trains, enhancing the security of operations and comfort.

7. References

- Andersson, S.; Söderberg, A. & Björklund, S. (2007), Friction models for sliding dry, boundary and mixed lubricated contacts, *Tribology International*, 40, ELSEVIER, pp. 580-587, ISSN: 0301-679X
- Belforte, P.; Cheli, F.; Diana, G. & Melzi, S. (2008), Numerical and experimental approach for the evaluation of severe longitudinal dynamics of heavy freight trains, *Vehicle System Dynamics*, 46: 1, pp. 937 – 955, ISSN: 0042-3114; 1744-5159
- Cantone, L.; Crescentini, E.; Verzicco, R. & Vullo, V. (2009), A numerical model for the analysis of unsteady train braking and releasing manoeuvres, *Proc. IMechE Vol. 223 Part F: J. Rail and Rapid Transit*, pp. 305-317, ISSN: 0954-4097; 2041-3017
- Cruceanu, C. (2009), *Brakes for Railway Vehicles* (in romanian), 3rd edition, Ed. MATRIXROM, Bucharest, ISBN 978-973-755-200-6
- Cruceanu, C.; Oprea, R.; Spiroiu, M.; Craciun, C. & Arsene, S. (2009), Computer Aided Study Regarding the Influence of Filling Characteristics on the Longitudinal Reaction within the Body of a Braked Train, *Recent Advances in Computers, Proceedings of the 13th WSEAS International Conference on Computers*, Rodos Island, Greece, July 23-25, 2009, pp 531-537, ISSN: 1790-5109
- Givoni, M. & Banister, D. (2009). *Reinventing the wheel - planning the rail network to meet mobility needs of the 21st century*, Transport Studies Unit, Oxford University Centre for the Environment, <http://www.tsu.ox.ac.uk/>
- Karvatski, B.L. (1950), *General theory of automated brakes* (in romanian), OPED-C.F.R., Bucharest, 1950
- Nasr, A. & Mohammadi, S. (2010), The effects of train brake delay time on in-train forces, *Proc. IMechE Vol. 224 Part F: J. Rail and Rapid Transit*, pp. 523-534
- Piechowiak, T. (2010) Verification of pneumatic railway brake models, *Vehicle System Dynamics*, 48: 3, pp. 283 – 299, ISSN: 0042-3114; 1744-5159
- Pouillet, P. (1974), Expérimentation par la SNCF, d'un frein électromagnétique à courants Foucault, *R.G.C.F.*, 93-ème anné nr. 3, pp. 169-176, ISSN: 0035-3183
- Pugi, L.; Fioravanti, D. & Rindi, L. (2007), Modelling the longitudinal dynamics of long freight trains during the braking phase, *12th IFToMM World Congress, Besançon (France)*, June18-21, http://iftomm.appsci.queensu.ca/proceedings/proceedings_WorldCongress/WorldCongress07/articles/sessions/papers/A822.pdf

- Pugi, L.; Malvezzi, M.; Allotta, B.; Bianchi L. & Presciani, P. (2004), A parametric library for the simulation of a Union Internationale des Chemins de Fer (UIC) pneumatic braking system, *Proc. IMechE Vol. 218 Part F: J. Rail and Rapid Transit*, pp. 117-132, ISSN: 0954-4097; 2041-3017
- Pugi, L.; Palazzolo, A. & Fioravanti, D., (2008), Simulation of railway brake plants: an application to SAADKMS freight wagons, *Proc. IMechE Vol. 222 Part F: J. Rail and Rapid Transit*, pp. 321-329, ISSN: 0954-4097; 2041-3017
- Schykowski, J. (2008), Eddy-current braking: a long road to success, *Railway Gazette International*, <http://www.railwaygazette.com/news/single-view/view/eddy-current-braking-a-long-road-to-success.html>
- Sookawa, H.; Saito, T. & Shimizu, K. (1970), Experimental Results for Temperature Rise of the Rail when Applying Eddy Current Rail Brake, *Quarterly Reports*, vol 11, nr. 1, pp. 40-41, ISSN: 0033-9008
- Sookawa, H.; Sato, Y. & Tomizawa, M. (1971), Running Tests of Eddy Current Rail Brake Set to a New Test Electric Car, *Quarterly Reports*, vol 12, nr. 3, pp. 138-141, ISSN: 0033-9008
- Uherek, E.; Halenka, T.; Borken-Kleefeld, J.; Balkanski, Y.; Berntsen, T.; Borrego, C.; Gauss, M.; Hoor, P.; Juda-Rezler, K.; Lelieveld, J.; Melas, D.; Rypdal, K. & Schmid, S. (2010), Transport impacts on atmosphere and climate: Land transport, *Atmospheric Environment* 44, pp. 4772-4816, ELSEVIER, ISSN: 1352-2310
- Zobory, I.; Reimerdes, H.G. & Békefy, E. (2000), Longitudinal Dynamics of Train Collisions-Crash Analysis, *7th Mini Conf. on Vehicle System Dynamics, Identification and Anomalies*, Budapest, Nov. 6-8, pp. 89-110, <http://www.railveh.bme.hu/Publikaciok/Zobory-Reim-Bek-Mar-Nem-Mini-7.pdf>
- Zhuan, X., *Optimal Handling and Fault-tolerant Speed Regulation of heavy Haul Trains*, Doctoral Thesis, Univ. of Pretoria, Oct. 2006
- O.R.E., Question B 36. Dispositifs élastiques des appareils de choc et traction. *Rapport No. 9: Etudes théoriques sur l'allure de l'effort longitudinal dans les trains de marchandises avec dispositifs élastiques classiques (effort uniquement fonction de la course)*, Utrecht, avril 1972
- O.R.E., Question B 36. Dispositifs élastiques des appareils de choc et traction. *Rapport No. 22: Calculs théoriques des efforts longitudinaux se produisant dans les train*, Utrecht, avril 1980
- UIC leaflet 520: *Güterwagen, Reisezugwagen und Gepäckwagen - Teile der Zugeinrichtung*, 7 Ausgabe, Dezember 2003, ISBN: 2-7461-0679-5
- UIC leaflet 526-1: *Wagons - Buffers with a stroke of 105 mm*, 3rd edition, July 2008, ISBN: 2-7461-1463-1
- UIC leaflet 526-2: *Wagons - Buffers with a stroke of 75 mm*, 1st edition of 1.1.81
- UIC leaflet 526-3: *Wagons- Buffers with a stroke of 130 and 150 mm*, 3rd edition, October 2008, ISBN: 978-2-7461-1472-0
- UIC leaflet 528: *Buffer gear for coaches*, 8th edition, September 2007, ISBN: 2-7461-1323-6
- UIC leaflet 540: *Brakes - Air Brakes for freight trains and passenger trains*, 5th edition, November 2006, ISBN: 2-7461-1172-1
- UIC leaflet 541-3: *Brakes - Disc brakes and their application - General conditions for the approval of brake pads*, 7th edition, October 2010, ISBN: 978-2-7461-1835-5
- UIC leaflet 541-5: *Brakes - Electropneumatic brake - Electropneumatic emergency brake override*, 4th edition, May 2006, ISBN: 2-7461-1027-X
- UIC leaflet 541-6: *Brakes - Electropneumatic brake and Passenger alarm signal for vehicles used in hauled consists*, 1st edition, October 2010, ISBN: 978-2-7461-1843-0
- UIC leaflet 544-1: *Brakes - Braking power*, 4th edition, October 2004, ISBN: 2-7461-0774-0

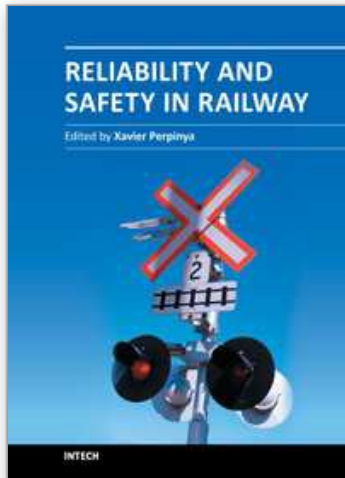

Reliability and Safety in Railway

Edited by Dr. Xavier Perpinya

ISBN 978-953-51-0451-3

Hard cover, 418 pages

Publisher InTech

Published online 30, March, 2012

Published in print edition March, 2012

In railway applications, performance studies are fundamental to increase the lifetime of railway systems. One of their main goals is verifying whether their working conditions are reliable and safety. This task not only takes into account the analysis of the whole traction chain, but also requires ensuring that the railway infrastructure is properly working. Therefore, several tests for detecting any dysfunctions on their proper operation have been developed. This book covers this topic, introducing the reader to railway traction fundamentals, providing some ideas on safety and reliability issues, and experimental approaches to detect any of these dysfunctions. The objective of the book is to serve as a valuable reference for students, educators, scientists, faculty members, researchers, and engineers.

How to reference

In order to correctly reference this scholarly work, feel free to copy and paste the following:

Cătălin Cruceanu (2012). Train Braking, Reliability and Safety in Railway, Dr. Xavier Perpinya (Ed.), ISBN: 978-953-51-0451-3, InTech, Available from: <http://www.intechopen.com/books/reliability-and-safety-in-railway/braking-systems-for-railway-vehicles>

INTECH
open science | open minds

InTech Europe

University Campus STeP Ri
Slavka Krautzeka 83/A
51000 Rijeka, Croatia
Phone: +385 (51) 770 447
Fax: +385 (51) 686 166
www.intechopen.com

InTech China

Unit 405, Office Block, Hotel Equatorial Shanghai
No.65, Yan An Road (West), Shanghai, 200040, China
中国上海市延安西路65号上海国际贵都大饭店办公楼405单元
Phone: +86-21-62489820
Fax: +86-21-62489821

© 2012 The Author(s). Licensee IntechOpen. This is an open access article distributed under the terms of the [Creative Commons Attribution 3.0 License](#), which permits unrestricted use, distribution, and reproduction in any medium, provided the original work is properly cited.

IntechOpen

IntechOpen