

We are IntechOpen, the world's leading publisher of Open Access books Built by scientists, for scientists

4,800

Open access books available

122,000

International authors and editors

135M

Downloads

Our authors are among the

154

Countries delivered to

TOP 1%

most cited scientists

12.2%

Contributors from top 500 universities



WEB OF SCIENCE™

Selection of our books indexed in the Book Citation Index
in Web of Science™ Core Collection (BKCI)

Interested in publishing with us?
Contact book.department@intechopen.com

Numbers displayed above are based on latest data collected.

For more information visit www.intechopen.com



Fuzzy Logic Control for Multiresolutive Adaptive PN Acquisition Scheme in Time-Varying Multipath Ionospheric Channel

Rosa Maria Alsina-Pages, Claudia Mateo Segura,
Joan Claudi Socoró Carrié and Pau Bergada
*La Salle - Universitat Ramon Llull
Spain*

1. Introduction

Communication with remote places is a challenge often solved using satellites. However, when trying to reach Antarctic stations, this solution suffers from poor visibility range and high operational costs. In such scenarios, skywave ionospheric communication systems represent a good alternative to satellite communications.

The Research Group in Electromagnetism and Communications (GRECO) is designing an HF system for long haul digital communication between the Antarctic Spanish Base in Livingston Island (62.6S, 60.4W) and Observatori de l'Ebre in Spain (40.8N,0.5E) (Vilella et al., 2008). The main interest of Observatori de l'Ebre is the transmission of the data collected from the sensors located at the base, including a geomagnetic sensor, a vertical incidence ionosonde, an oblique incidence ionosonde and a GNSS receiver. The geomagnetic sensor, the vertical incidence ionosonde and the GNSS receiver are commercial solutions from third parties. The oblique incidence ionosonde, used to sound the ionospheric channel between Antarctica and Spain, was developed by the GRECO in the framework of this project.

During the last Antarctic campaign, exhaustive measurements of the HF channel characteristics were performed, which allowed us to determine parameters such as availability, SNR, delay and Doppler spread, etc. In addition to the scientific interest of this sounding, a further objective of the project is the establishment of a backup link for data transmission from the remote sensors in the Antarctica. In this scenario, ionospheric communications appear to be an interesting complementary alternative to geostationary satellite communications since the latter are expensive and not always available from high-latitudes.

Research work in the field of fuzzy logics applied to the estimation of the above mentioned channel was first applied in (Alsina et al., 2005a) for serial search acquisition systems in AWGN channels, afterwards applied to the same channel but in the multiresolutive structure (Alsina et al., 2009a; Morán et al., 2001) in papers (Alsina et al., 2007b; 2009b) achieving good results. In this chapter the application of fuzzy logic control trained for Rayleigh fading channels (Proakis, 1995) with Direct-Sequence Spread-Spectrum (DS-SS) is presented, specifically suited for the ionospheric channel Antarctica-Spain. Stability and reliability of the reception, which are currently being designed, are key factors for the reception.

It is important to note that the fuzzy control design presented in this chapter not only resolves the issue of improving the multiresolutive structure performance presented by (Morán et al., 2001), but also introduces a new option for the control design of many LMS adaptive structures used for PN code acquisition found in the literature. (El-Tarhuni & Sheikh, 1996) presented an LMS-based system to acquire a DS-SS system in Rayleigh channels; years after, (Han et al., 2006) improved the performance of the acquisition system designed by (El-Tarhuni & Sheikh, 1996). And also in other type of channels, LMS filters are used as an acquisition system, even in oceanic transmissions (Stojanovic & Freitag, 2003). Although the fuzzy control system presented in this chapter is compared to the stability control used in (Morán et al., 2001) it also can be used to improve all previous designs performance in terms of stability and robustness. Despite this generalization, the design of every control system should be done according to the requirements of the acquisition system and the specific channel characteristics.

2. Background and system requirements

The design of the transmitter and the receiver, as well as the modulation used to carry out data transmission is severely conditioned to Antarctica constraints. Power restrictions, low bitrate needed and multipath are requirements to be taken into account in the decisions.

2.1 Ionospheric channel and BAE restrictions

One of the major constraints is that, due to power restrictions in the Antarctic Base, the transmission power is strongly limited. Consequently, a very low SNR is usually expected at the receiver. However, when using DS-SS techniques, signal spectrum is spread over a wide bandwidth, becoming robust against narrowband interferences.

Previous research efforts have been focused on using pseudorandom sequences with good autocorrelation characteristics (m-sequences) to evaluate the four-five hops link (12700km length) from Antarctica to Observatori de l'Ebre (Spain). Channel estimation and impairment characteristics have been obtained from these previous experiments (Vilella et al., 2008). DS-SS has also been previously used as a signaling technique (Deumal et al., 2006), for DS-SS modulation (Alsina et al., 2009a) or for OFDM modulation (Bergadà et al., 2009), achieving good results in terms of spectral efficiency although scarcely decreasing the system performance. These outcomes encouraged us to consider DS-SS a proper candidate to modulate the transmitted data. An advantage of DS-SS modulation (Glisic & Vucetic, 1997; Peterson et al., 1995) is that channel estimation is not essential in the demodulation stage, but it can be used to improve its reliability (i.e. using a RAKE receiver).

2.2 Direct-Sequence Spread-Spectrum transmission

Direct-Sequence Spread-Spectrum (Peterson et al., 1995) is a modulation technique that, as well as other spread spectrum technologies, increases the transmitted signal bandwidth and occupies a wider bandwidth (see $x[n]$ in Figure 1) than the information signal (see $b[n]$ in Figure 1) that is being modulated. DS-SS pseudorandomly modulates the wave with a continuous string of pseudonoise (PN) code symbols (see $c[n]$ in Figure 1) called *chips*. Chips are of shorter duration than information bits, hence the wider spectrum and the higher chip rate. So, the chip rate is higher than the information signal bit rate (see Figure 1). DS-SS uses a sequence of chips generated by the transmitter, and also known by the receiver; the

receiver can then use the same PN sequence to counteract the effect of the PN sequence used to modulate in the transmitter, in order to reconstruct the information signal.

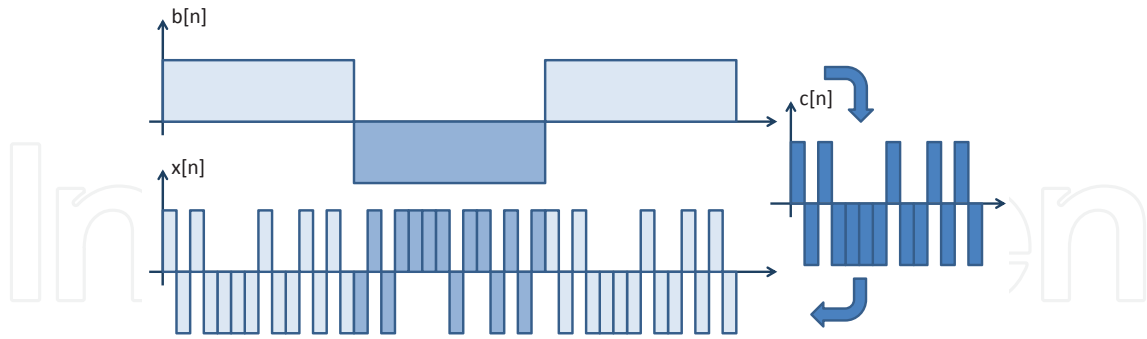

Fig. 1. The DS-SS signal $x[n]$ is generated through multiplication of the information base-band signal $b[n]$ with the (periodic) spreading sequence $c[n]$

One of the main challenges to be solved by DS-SS systems is to achieve a quick and robust acquisition of the pseudonoise sequences (PN sequences). In time-varying environments this fact becomes even more important, because acquisition and tracking performance can heavily degrade communication reliability.

There are several schemes to deal with this problem, such as serial search and parallel algorithms (Sklar, 1988). Serial search algorithms require a low computational load but they are slow to converge. On the other hand, parallel systems are fast converging but require a high computational load. In our system, the low-complexity fast-converging multiresolutive structure that was previously presented in (Morán et al., 2001) is used. Nevertheless, a proper design of the decisional system is a key factor in the overall system performance. This is even more important when dealing with time varying channels with a variable SNR.

Several factors contribute to the performance of the acquisition system (Glisic & Vucetic, 1997): uncertainty about the code phase, channel distortion and variations, noise and interference, and data randomness. Therefore, advanced control systems as fuzzy logic (Zadeh, 1965; 1988) are used to solve this complex acquisition problem. The fuzzy logic estimator used in this chapter was first presented by our research group in (Alsina et al., 2005a) and (Alsina et al., 2008; 2007b; 2009b); in this study, a new control system with a new set of If-Then Rules is presented to cope with the multipath time-variant ionospheric channel (Alsina et al., 2009a).

2.3 Fuzzy logic as an acquisition control

The decision of using fuzzy logic (Zadeh, 1965; 1988) for the acquisition control of the multiresolutive structure (Morán et al., 2001) is based in the high accuracy of fuzzy logic in terms of complex system description. The behavior of the channel is well-known, as a result of several research studies (Vilella et al., 2009; 2008), thus the control performance can be manually adjusted, by means of the acquisition system knowledge.

Fuzzy logic has been widely used to solve engineering problems (Gad & Farouq, 2001). More specifically, (Daffara, 1995) and (Drake & Prasad, 1999) used fuzzy logic to track phase error detectors in synchronization, while (Perez-Neira & Lagunas, 1996) and (Perez-Neira et al., 1997) improved detection results by means of this technique. Finally, (Bas & Perez-Neira, 2003) applied fuzzy logic to interference rejection. These applications are based in the same

principles that the one presented in this chapter; the wide knowledge of a system performance by the designer, which fuzzy logic helps to translate to a closed control system.

3. Multiresolutive structure for acquisition and tracking

The aim of the multiresolutive scheme (Morán et al., 2001) is to find the correct acquisition point with low latency and simultaneously requiring low computational cost in a DS-SS transmission. The transmitted signal, the base band continuous signal before spectral shaping is:

$$x(t) = \sum_{i=1}^I b_i \cdot c(t - i \cdot T_s) \quad (1)$$

where b_i are the information bits, I is the total number of transmitted bits and T_s is the bit duration in seconds. The received base band signal, after downconversion and filtering is:

$$r(t) = \sum_{j=1}^L \gamma_j(t) \cdot x(t - \tau_j(t)) + n(t) \quad (2)$$

where L is the number of multipath components, γ_j is the complex fading coefficient of the j th component, and τ_j is the delay of the j th component. The input signal for the multiresolutive structure is $s[n] = r(n \cdot \frac{T_c}{N})$ (see Figure 2), so it is assumed to be sampled at the frequency of Nf_c , where $f_c = 1/T_c$ is the chip frequency (in number of chips per second) and T_c is the chip duration in seconds. The PN sequence used as reference in the acquisition scheme is also sampled at Nf_c , so is $c[n] = c(n \cdot \frac{T_c}{N})$.

As can be shown in Figure 2, in the acquisition part the signal $s[n]$ is first decimated by a factor N (and then N is the number of samples per chip). Since the acquisition stage can accept uncertainties lower than the chip period, the computational load is reduced by decimating without affecting the performance.

3.1 Acquisition stage

The decimated signal, termed as $s_{dec}[n]$, is fed into the filters of a multiresolutive structure (see Figure 2). There are M different branches that work with decimated versions of the input signal, separated in M disjoint subspaces. Each branch has an adaptive FIR filter of length $H = \left\lceil \frac{PG}{M} \right\rceil$, where PG is the Processing Gain (corresponding to the length of the PN sequence), trained with a decimated version of the PN modulating sequence (c_{dec}), and $\lceil \cdot \rceil$ stands for the ceil operator. FIR filters use the LMS algorithm as adaptive coefficient update procedure and their performance were compared to other adaptive filters; they stand out for being the best in terms of speed of convergence and reliability (Akhter et al., 2010).

LMS filters converge with a steepest descent algorithm (Haykin, 1996), using a convergence parameter μ that has to be adjusted according to the system requirements of stability and time convergence. The steepest descent algorithm is detailed in:

$$w_{k+1} = w_k + \mu e_k s_k^{dec} \quad (3)$$

where w_{k+1} is the tap weight vector at (chip-based) sample time index $k + 1$ and w_k is the tap weight vector at index time k , e_k is the output error at time k and s_k^{dec} is the input signal. μ is

the step-size parameter that controls the speed of convergence and the robustness of the filter. It is a parameter that has been carefully designed.

Under ideal conditions, in a non-frequency selective Rayleigh channel with white Gaussian noise, just one of the filters should locally converge to a Dirac delta response like

$$\gamma[k]b_i[n]\delta[k - \tau] \tag{4}$$

where $b_i[n]$ is the information bit, τ represents the chip-based delay between the input signal PN sequence and the reference one and $\gamma[k]$ is the fading coefficient. The algorithm is reseted every symbol period, and a modulus smoothing average algorithm is applied to each LMS filter coefficients solution $W_i[n]$ to remove the data randomness component $b_i[n]$ of Equation 4, obtaining nonnegative averaged impulsional responses $W_i^{av}[n]$.

$$W_{i+1}^{av}[n] = (1 - \beta)W_i^{av}[n] + \beta|W_i[n]| \tag{5}$$

The exponential smoothing filter and the choice of the proper value of the parameter β are fundamental for the good performance of the multiresolutive structure; it is important to note that $|\cdot|$ is the modulus for each coefficient of $W_i[n]$. The design of such components of the multiresolutive structure is optimized in order to stabilize the dynamics of the tap filter coefficients, avoiding impulsive changes due to SNR variations or fast fading.

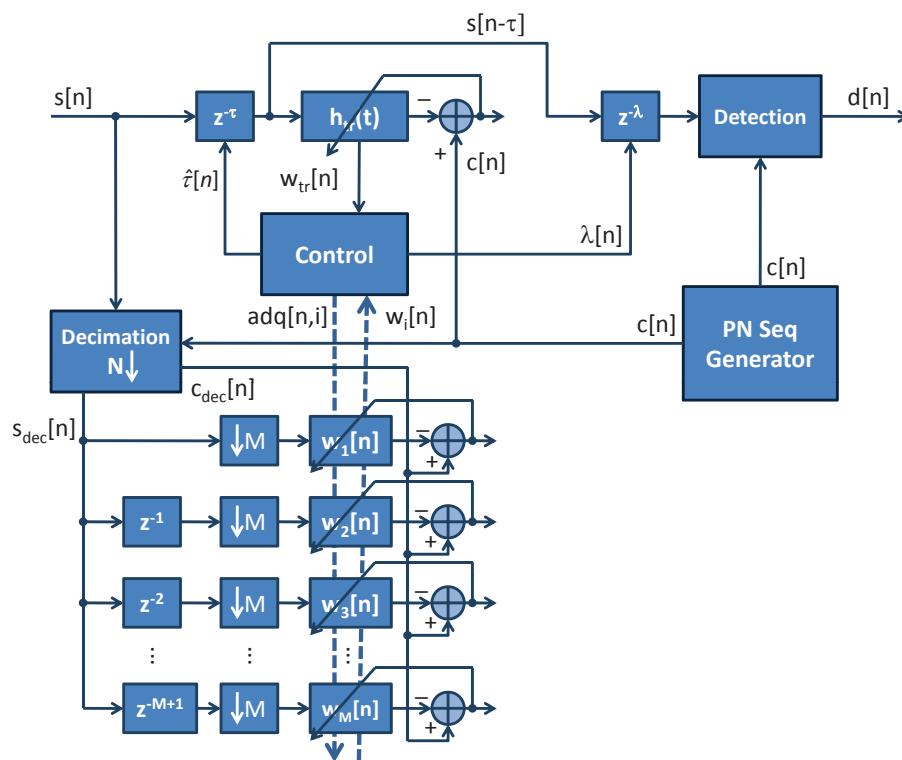

Fig. 2. Multiresolutive structure for acquisition and tracking

A peak detection algorithm is used by the decisional system embedded in the control stage (see Figure 2) which of the acquisition filters has detected the signal (say $W_{con}[n]$), considering $W_{con}[n]$ is the filter coefficients after the convergence. The coarse estimation of the acquisition point is given by the position of the maximum, say n_{max}^i , in the selected filter.

3.2 Tracking stage

Once restored the acquisition point by the decisional system, tracking is solved with another adaptive FIR filter with impulse response $W_{tr}[n]$ (of length H and also using the LMS algorithm as the coefficient update procedure), which expands the search window around the coarse acquisition point n_{max} , using the full bandwidth input signal $s[n]$. The result of the tracking filter is also smoothed using an exponential smoothing as detailed in Section 3.1. Finally, the estimation of the acquisition point is refined by finding the tracking point (see Figure 2, values $\hat{\tau}$) and the signal can be correctly demodulated.

3.3 Control stage

The control stage of the multiresolutive structure is a key step in this design (Alsina et al., 2009b). The stability and the robustness of the multiresolutive structure are supported by the control system, apart from the quality of the acquisition of the multiresolutive structure. The control system is based on the measurements over the LMS filters used in acquisition and tracking: *i*) $W_i^{av}[n]$ corresponding to the averaged impulse responses of the tracking filters; *ii*) $W_{con}^{av}[n]$, referring to the current acquisition filter that gives the current acquisition point; and *iii*) $W_{tr}^{av}[n]$ as the tracking filter.

Using this information provided by the acquisition and tracking, the decisional system determines if the system is acquired and demodulation can start, or otherwise the acquisition system must remain in the process of acquisition and tracking of a proper point.

In this project the decisional system is based on fuzzy logic (Zadeh, 1988), due to the deep knowledge of the channel behavior acquired in numerous tests involving different kinds of modulations. These tests did not only provide valuable information about the performance of the LMS adaptive filters both in acquisition and tracking, but also how this performance reflects in the *Acquisition* estimation as is shown in Section 4.

4. The acquisition fuzzy control

The acquisition control is designed using information from the impulsional response of the LMS filters of the multiresolutive structure after being smoothed. Their values give information about the probability of being correctly acquired, and this information feeds the fuzzy decisional system designed for the multiresolutive structure.

Previous work started with the design of a fuzzy control for a serial search algorithm based on a CFAR scheme (Glisic, 1991), work presented in (Alsina et al., 2005a). Afterwards, the fuzzy estimator was adapted to the multiresolutive structure (Morán et al., 2001), in order to improve its performance in channels with fast SNR variations. This design and study was presented in (Alsina et al., 2007b) and in (Alsina et al., 2009b). Then, the fuzzy logic estimator was compared with a neural network based control, work presented in (Alsina et al., 2008).

The input variable definition presented in this paper (corresponding to the four ratios $Ratio_1$, $Ratio_2$, $Ratio_3$ and $Ratio_{1trac}$) was initialized in (Alsina et al., 2007b). As the design of a fuzzy logic system is highly dependent on the environment where it works, in this paper it has been specifically redesigned and adapted to a ionospheric Rayleigh channel (Proakis, 1995). The number of membership functions and their position have changed, but not the main basis of the variable definition with respect to previous work where fuzzy logic control was used

(Alsina et al., 2007b). The knowledge of the performance of the multiresolutive structure is a key process for both the first channel (fast SNR variation channel) and for the ionospheric Rayleigh channel currently used.

4.1 Input variables and fuzzy sets

In this Section a detailed explanation of the input variables and their meaning is given. Each input variable is defined and it is chosen according to the information it generates to improve the control performance. Once the four input variables are detailed, they are tested using a family of 10 PN sequences previously designed (Alsina et al., 2005b; 2007a) to improve the multiresolutive structure capabilities. As will be shown (see Section 4.1.2.2), there are substantial differences in the performance of each of the PN sequences in terms of input variables, so a preferred sequence is chosen; the minimization of the values of autocorrelation and crosscorrelation - which contribute to the fitness function of the GA algorithm (Alsina et al., 2007a) - is taken into account. Afterwards, the median and the lower and upper quartiles of the input variables are studied for the preferred sequence; finally the membership functions are defined.

4.1.1 Input variables

Four parameters are defined as inputs in the fuzzy logic control system; three of them refer to the values of the four modulus averaged acquisition LMS filters ($W_i^{av}[n]$), especially the LMS filter adapted and synchronized with the decimated sequence c_{dec} (named $W_{con}^{av}[n]$), and one to the tracking filter ($W_{tr}^{av}[n]$):

- *Ratio*₁: it is computed as the quotient of the peak value of the LMS filter ($W_{con}^{av}[n_{max}^i]$) divided by the mean value of this filter but the maximum (consider n_{max}^i as the LMS maximum equivalent to reconstructed acquisition point, named τ in Figure 2):

$$Ratio_1 = \frac{W_{con}^{av}[n_{max}^i]}{\frac{1}{H} \sum_{\substack{n=1 \\ n \neq n_{max}^i}}^H W_{con}^{av}[n]} \quad (6)$$

- *Ratio*₂: it is evaluated as the quotient of the peak value of the LMS filter ($W_{con}^{av}[n_{max}^i]$) divided by the average of the value of the same position in the other three filters ($W_i^{av}[n]$):

$$Ratio_2 = \frac{W_{con}^{av}[n_{max}^i]}{\frac{1}{M-1} \sum_{\substack{i=1 \\ i \neq con}}^M W_i^{av}[n_{max}^i]} \quad (7)$$

- *Ratio*₃: it is obtained as the quotient of the peak value of the LMS filter ($W_{con}^{av}[n_{max}^i]$) divided by the mean value of the three other filters ($W_i^{av}[n]$):

$$Ratio_3 = \frac{W_{con}^{av}[n_{max}^i]}{\frac{1}{M-1} \frac{1}{H-1} \sum_{\substack{i=1 \\ i \neq con}}^M \sum_{\substack{n=1 \\ n \neq n_{max}^i}}^H W_i^{av}[n]} \quad (8)$$

- *Ratio*₁: it is computed as the quotient of the peak value of the LMS tracking filter ($W_{tr}^{av}[n_{max}]$), being n_{max} the most precise estimation of the correct acquisition point,

divided by the mean value of the same filter but the maximum (consider n_{max} as the LMS maximum equivalent to reconstructed tracking point named λ in Figure 2).

$$Ratio_{1trac} = \frac{W_{tr}^{av}[n_{max}]}{\frac{1}{H} \sum_{\substack{n=1 \\ n \neq n_{max}}}^H W_{tr}^{av}[n]} \quad (9)$$

$Ratio_1$ gives information about the signal to noise ratio of the channel; in second term it also reflects the mean autocorrelation of the decimated signal used as reference. If the mean values of the tap weights of the converged filter are high, $Ratio_1$ shows a wide dynamic margin to define all membership functions, which means that the autocorrelation for c_{dec} is not negligible. $Ratio_2$ shows information about the SNR and about the delay spread of the channel; if the received data is not spread around the contiguous chips of the detected tracking position $Ratio_2$ obtains good dynamic margin. $Ratio_3$ gives information about the SNR at the receiver, and about the crosscorrelation between the four decimated versions of a PN sequence. If the crosscorrelation is high between subsequences, $Ratio_3$ achieves non-discriminative results and does not help acquisition. Finally, $Ratio_{1trac}$ gives information about the SNR at the receiver in terms of the entire sequence - not the decimated as the three previous ratios - . These parameters have been chosen due to the information they contain about the probability of successful acquisition related to their values; their output dynamic range can be divided into several membership functions referring to their value, in order to help the estimation of the acquisition stage.

4.1.2 Input fuzzy sets

In this Section the input fuzzy sets for each input variable are described. The input fuzzy sets with their membership functions need a ratio value estimation for each input variable. This studio is made for a family of 10 different PN sequences optimized to work with the multiresolutive structure (Alsina et al., 2007a).

A scenario description is firstly described, in order to detail the channel environment in which the tests are made. The channel or simulation settings are defined according to the information given by (Vilella et al., 2009; 2008), using measurements from real transmission campaigns. Lately, the four ratios curves for each scenario are obtained and explained for both acquisition and non-acquisition situations. This information leads us to choose the appropriate preferred PN sequences. Statistical parameters are computed over the performance of the preferred PN sequence, and membership functions are finally defined.

4.1.2.1 Scenario description

In order to train the system to work with real data, four simulation scenarios have been defined in Table 1. They are absolutely based on analysis of real data (Vilella et al., 2009; 2008), except for scenario 0, that is a simpler version of transmissions throughout ionospheric radiolink, considering only the most powerful path in a multipath scenario.

Table 1 is sorted by h_l , that is the hour time - during day or night -. For every hour, three SNR values are shown (-9 dB, -6 dB, -3 dB), measured using a transmission bandwidth $Bw = 3kHz$ around a carrier frequency f_l (expressed in MHz). $Dw_{f,\bar{j}}$ is the availability of each frequency in %. $\tau(h_l)_{F_k,\bar{j}}$, where $f_k \in F_k$, is the composite multipath spread in ms, and finally, $v(h_l)_{F_k,\bar{j}}$, where $f_k \in F_k$, is the Doppler spread in Hertz.

Best availability data from (Vilella et al., 2008) is considered for this research work.

Scenario	h_l	SNR	$Dw(h_l)_{f,j}$	$f_k = \underline{f}$	$\tau(h_l)_{F_k,j}, f_k \in F_l$	$v(h_l)_{F_k,j}, f_k \in F_k$
Scenario 0	-	-	-	-	-	1.2
		-9	82%	9	2	1.25
Scenario 1	01	-6	63%	9	2	1.25
		-3	36%	9	2	1.25
		-9	52%	13	1	1.2
Scenario 2	21	-6	43%	15	0.7	0.9
		-3	36%	15	0.7	0.9
		-9	50%	15	0.6	0.8
Scenario 3	08	-6	36%	15	0.6	0.8
		-3	18%	15	0.6	0.8

Table 1. Ionospheric simulation scenarios (Vilella et al., 2009; 2008)

4.1.2.2 Ratio values for each sequence and scenario

The PN sequence family used to test the four input ratios was designed using evolution strategies (Alsina et al., 2007b; 2005a), in order to satisfy the requirements of the multiresolutive structure (as shown in Figure 2 and in Section 3). This structure uses a decimated PN sequence to estimate the first acquisition point, and therefore it is convenient to obtain good autocorrelation for the decimated sequence, as well as a limited crosscorrelation between the M decimated versions of the PN sequence. These requirements have been used in the evolution strategy design, generating a family of PN sequences that not only minimized the autocorrelation and the crosscorrelation, but also these statistical parameters for the decimated sequences.

In Figures 3, 4, 5 and 6 a four-ratio comparison is made using the four simulation scenarios of Table 1. The four top subfigures plot the ratio values for the acquired situation; the four bottom subfigures plot the ratio values for non-acquired situation. This evaluation is made for each ratio ($Ratio_1$, $Ratio_2$, $Ratio_3$ and $Ratio_{1trac}$) and also for each scenario (scenario 0, scenario 1, scenario 2 and scenario 3) applying at each simulation a different SNR value in order to perform a noise value study.

Figure 3 shows a clear difference between the values for $Ratio_1$ in the case of acquisition and in the case of non-acquisition, especially for scenario 0. Scenario 1, scenario 2 and scenario 3 values for acquisition are not so stable, and neither are the values for the non-acquisition situation. This is a behavior that will be repeated for the four ratios: the first scenario is the one that allows a better discrimination between acquisition and non acquisition in terms of ratios, it is the clearest to detect an acquisition. In the other three scenarios, due to the fact that they produce multipath, the values for the ratios are more ambiguous.

Figure 4 presents very good results for nearly all the PN sequences of the family. These figures show that $Ratio_2$ can be used for performing an stable estimation of the decision to evaluate. Figure 5 shows a noisy $Ratio_3$; but despite its unstable values for the non-acquired situation, values for $Ratio_3$ in acquired scenarios 2 and 3, which are the worst results for the results tests, it exhibits a fairly distinct behavior in acquisition situation with respect to non-acquisition situation. Then $Ratio_3$ information is valuable in the case of severe channel conditions. Finally,

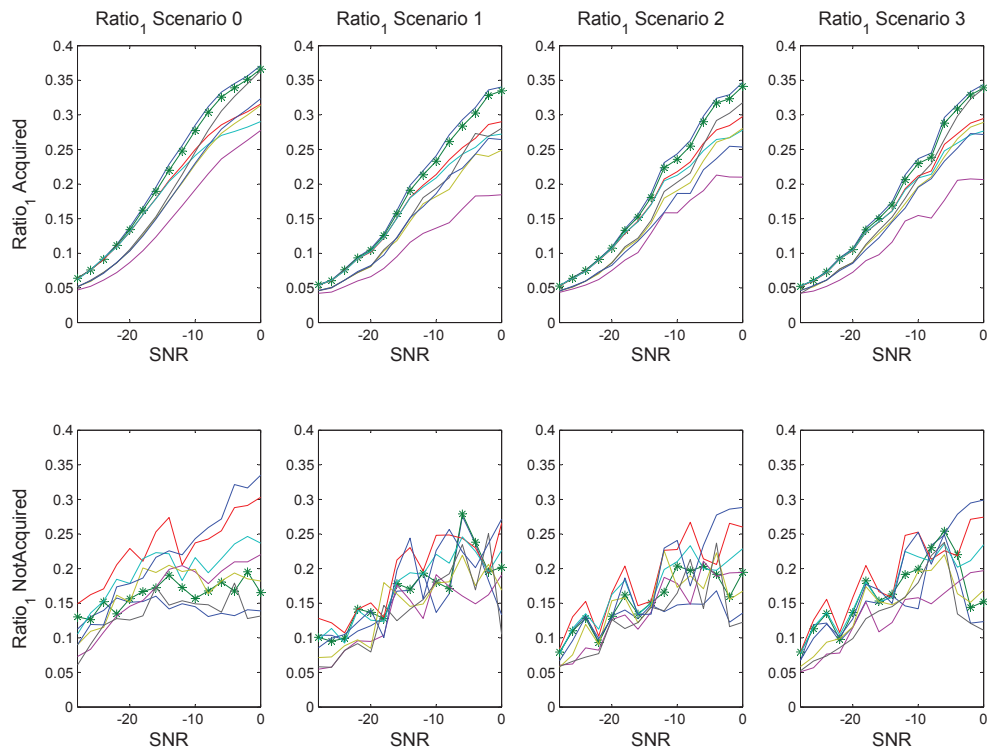

Fig. 3. Performance of the PN sequence ratio values for $Ratio_1$. The four upper figures show $Ratio_1$ values for the four scenarios in the acquired situation. The four lower figures show $Ratio_1$ values for the non-acquired situation.

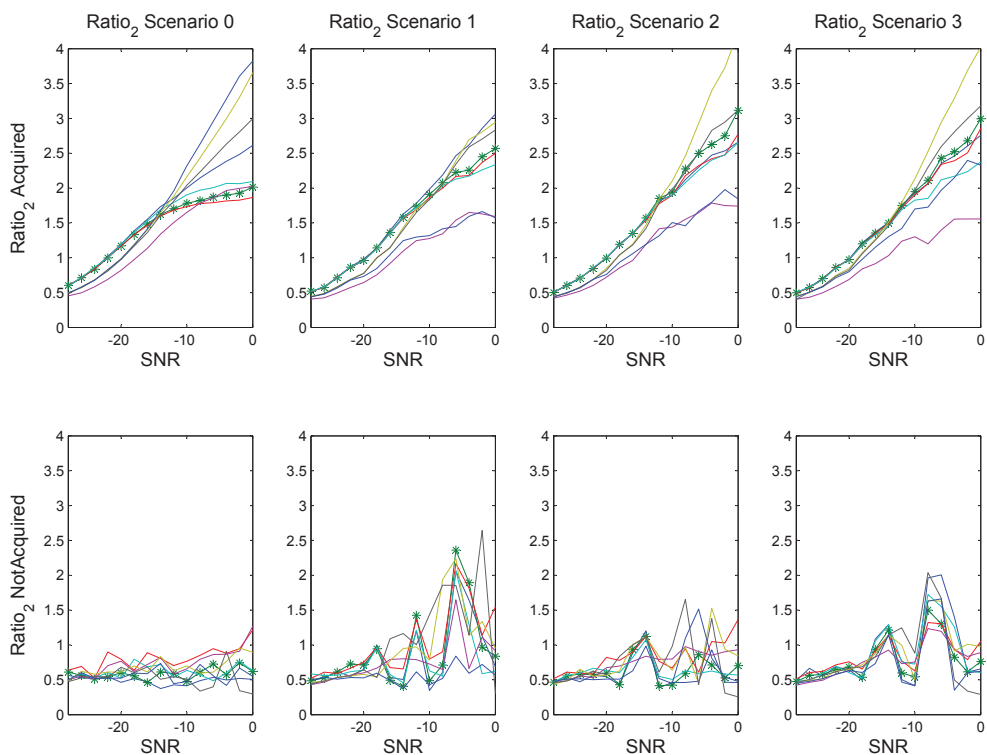

Fig. 4. Performance of the PN sequence ratio values for $Ratio_2$. The four upper figures show $Ratio_2$ values for the four scenarios in the acquired situation. The four lower figures show $Ratio_2$ values for the non-acquired situation.

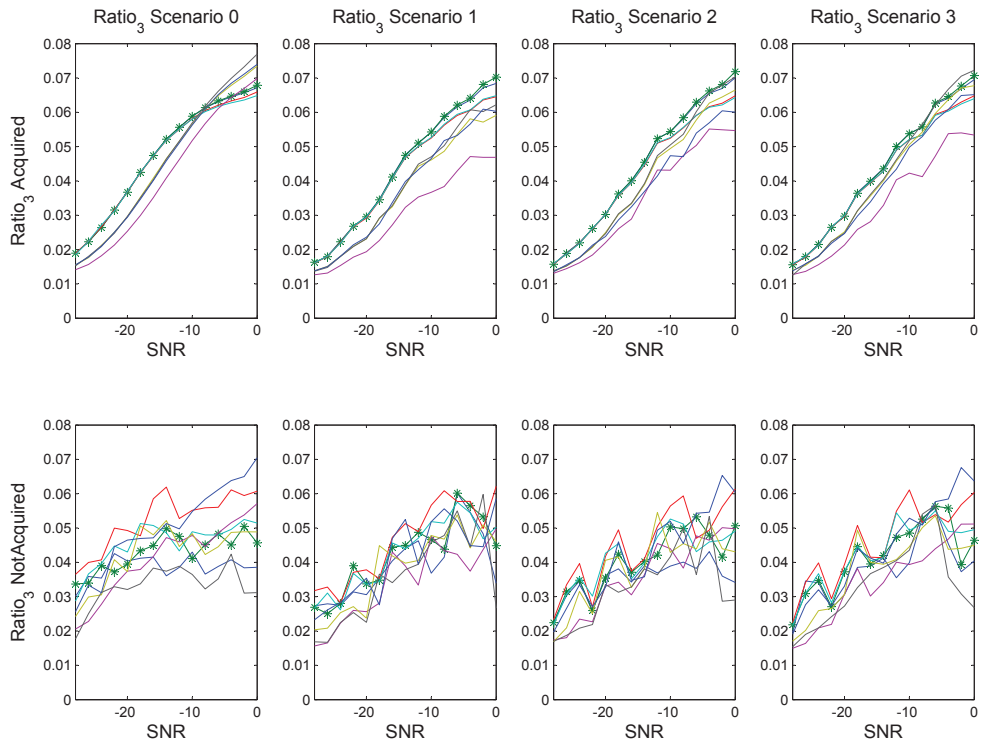

Fig. 5. Performance of the PN sequence ratio values for $Ratio_3$. The four upper figures show $Ratio_3$ values for the four scenarios in the acquired situation. The four lower figures show $Ratio_3$ values for the non-acquired situation.

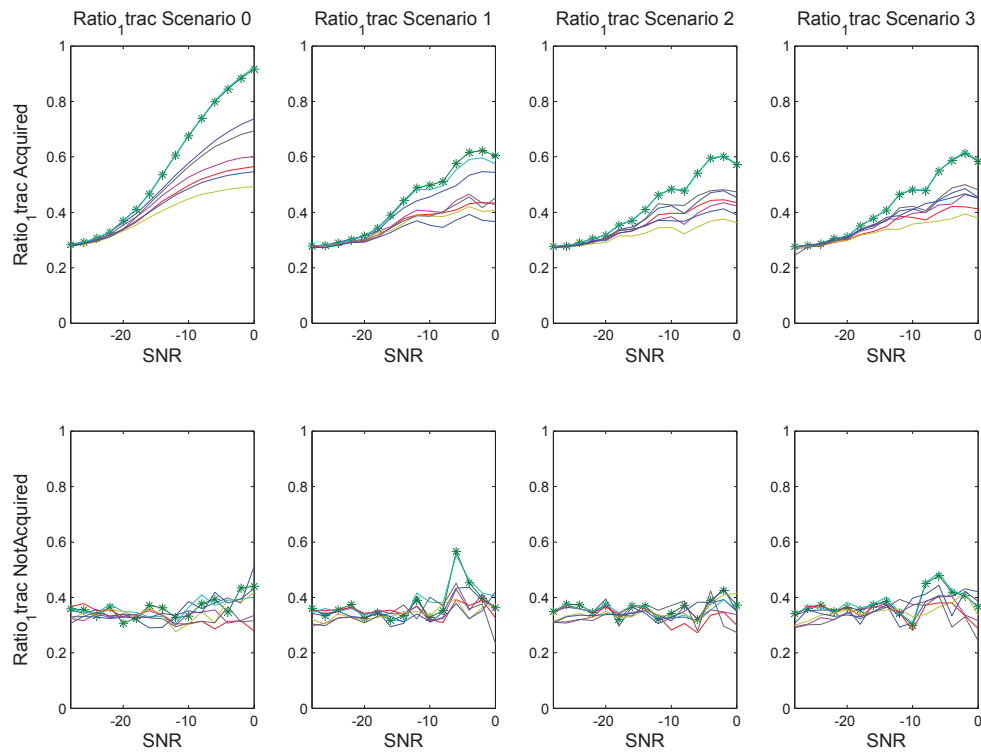

Fig. 6. Performance of the PN sequence ratio values for $Ratio_{1trac}$. The four upper figures show $Ratio_{1trac}$ values for the four scenarios in the acquired situation. The four lower figures show $Ratio_{1trac}$ values for the non-acquired situation.

Figure 6 plots the results for $Ratio_{1trac}$; they are the best results given by the system in the four scenarios and considering the four ratios. Nevertheless there is a drawback for $Ratio_{1trac}$: the system must be acquired for this value to be reliable, otherwise just a noisy amount of output values is shown.

This information is gathered, and one PN sequence is chosen for its good response to the four ratios in the four scenarios. This sequence is the dotted one in the four Figures (3, 4, 5 and 6). It has been chosen due to its minimization of the Euclidean distance with the best sequence at each ratio evaluation.

4.1.2.3 Selected sequence

The selected PN sequence is not the best one for all the ratios and for all the scenarios. It stands for the best global values, which means that is little noisy when comparing with the other sequences. In most of the results previously shown it reaches the best values (i.e. the values that better discriminates between acquisition and non acquisition).

Once chosen the preferred PN sequence, some statistics have to be computed over the ratios obtained using this sequence. The ratios are computed again for a wider group of values of SNR, and the results for the acquisition situation are shown in Figure 7. Over these results median, lower and upper quartiles are computed in order to fix some thresholds to define the membership functions in the fuzzy input variables. Figure 8 shows the boxplots of the values for $Ratio_1$ when acquired, and also performs the boxplots of the values for $Ratio_2$ when acquired. Figure 8 also gives the boxplots of the values for $Ratio_3$ when acquired and the values for $Ratio_{1trac}$ when acquired.

In the last figure, the median values for the four ratios simulated in the four scenarios, and the quartiles for these groups of ratios are also shown. Especially the quartiles over the four ratios when the system is acquired can be considered the key to tune the membership functions for the input variables.

4.1.2.4 Fuzzy membership functions

Finally, the input variables membership functions are defined. Four fuzzy sets have been defined for each variable; two for the acquisition situation and two for the non-acquisition situation; only for $Ratio_{1trac}$ is defined with five fuzzy sets, three for acquisition situation and two for the non-acquisition situation. Only four sets have been considered, because the system needs to give the clear idea of whether the receiver is acquired or not, assuming doubts. The four groups are named (from worse to best performance of the system) **Not Acquired**, **Probably Not Acquired** ($\sim NoAcq$), **Probably Acquired** ($\sim Acq$) and **Acquired**. The division between **Not Acquired** and **Probably Not Acquired** is the median value for the non-acquired situation; and the same for **Probably Acquired** and **Acquired**, the threshold is the median value for the acquired situation. The division between **Probably Not Acquired** and **Probably Acquired** is held assuming that the maximum values for each are the low and high, respectively, quartiles for each of the ratios. All values are obtained with the mean value for the four ratios observed, and in case of doubt, always states the worst case. Some of the thresholds for the membership functions follow the worst case studio rule. Figures for the membership functions for $Ratio_1$, $Ratio_2$ and $Ratio_3$ are shown in Figure 9, Figure 10 and 11, respectively. The only difference in the design is for membership functions of $Ratio_{1trac}$; this ratio gives enough information to affirm that for some very high values (see statistics in Figure 8), not only is acquired, but also is working with only one path, as shown in Figure 12.

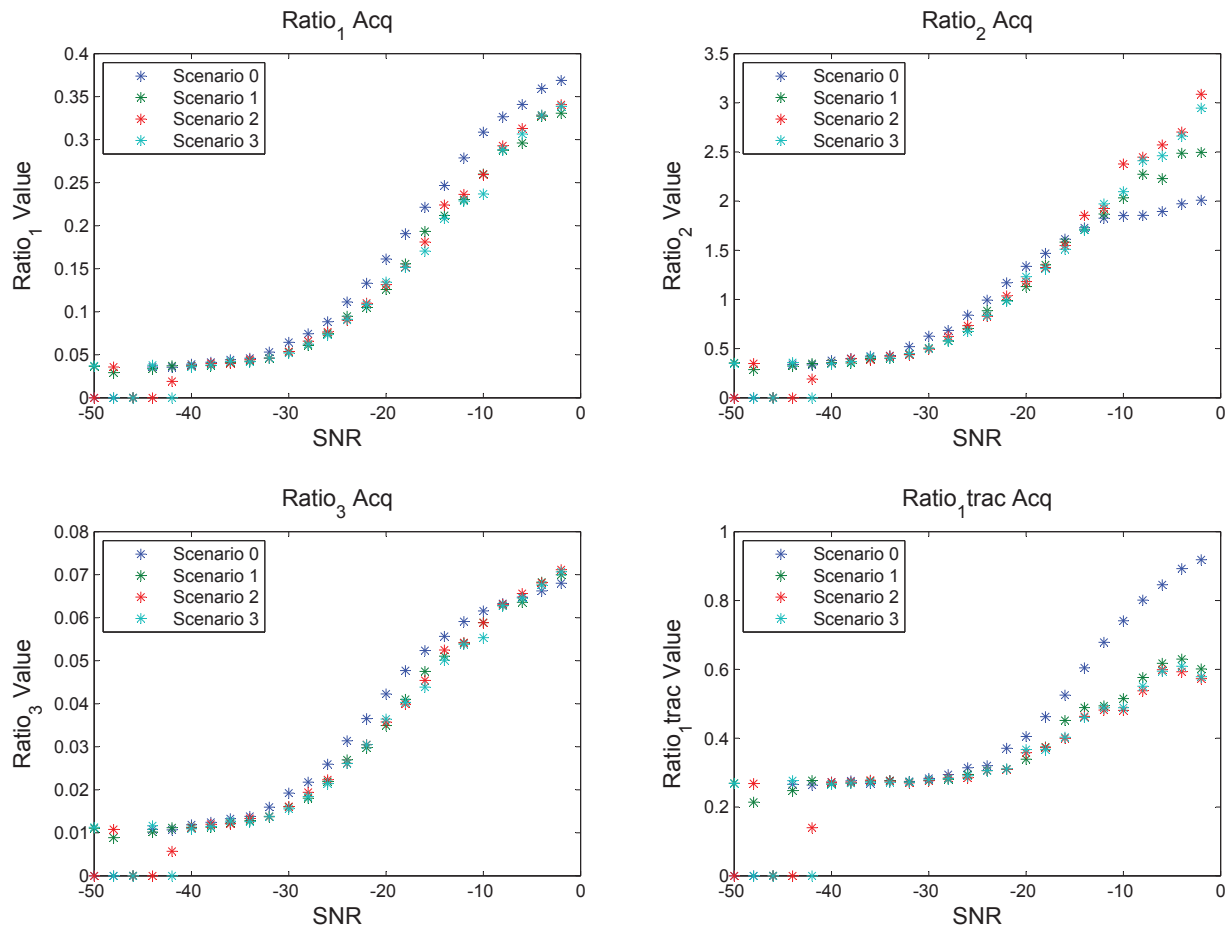

Fig. 7. Values for $Ratio_1$, $Ratio_2$, $Ratio_3$ and $Ratio_{1trac}$ for an Acquired situation

4.2 Output variable and fuzzy sets

The output parameter is *Acquisition*, which gives a value in the range [0,1], being zero when it is **Not Acquired** and one if it is **Acquired**. In between, two other fuzzy sets are defined: **Probably Not Acquired** and **Probably Acquired**.

The parameter *Acquisition* is used to give information to the detection stage about the reliability of the estimation. Notice that the multiresolutive structure gives an estimation of the acquisition point while the *Acquisition* value evaluates the probability of being acquired.

4.2.1 Output fuzzy sets

The critical values of the output variable *Acquisition*, around [0.4,0.6] are divided into two fuzzy sets, the lower one corresponding to **Probably Not Acquired** and the higher one corresponding to **Probably Acquired**. If the output variable obtains a critical value this is a result of non clear acquisition, so the decisional system does not have certainty about the reliability of the results. An additional period of time for acquisition is needed, and this is the goal of the definition of these two fuzzy sets.

For values over 0.6 and under 0.4 the output variable *Acquisition* is clearly defined, being the first one clearly acquired, and the second one clearly not acquired.

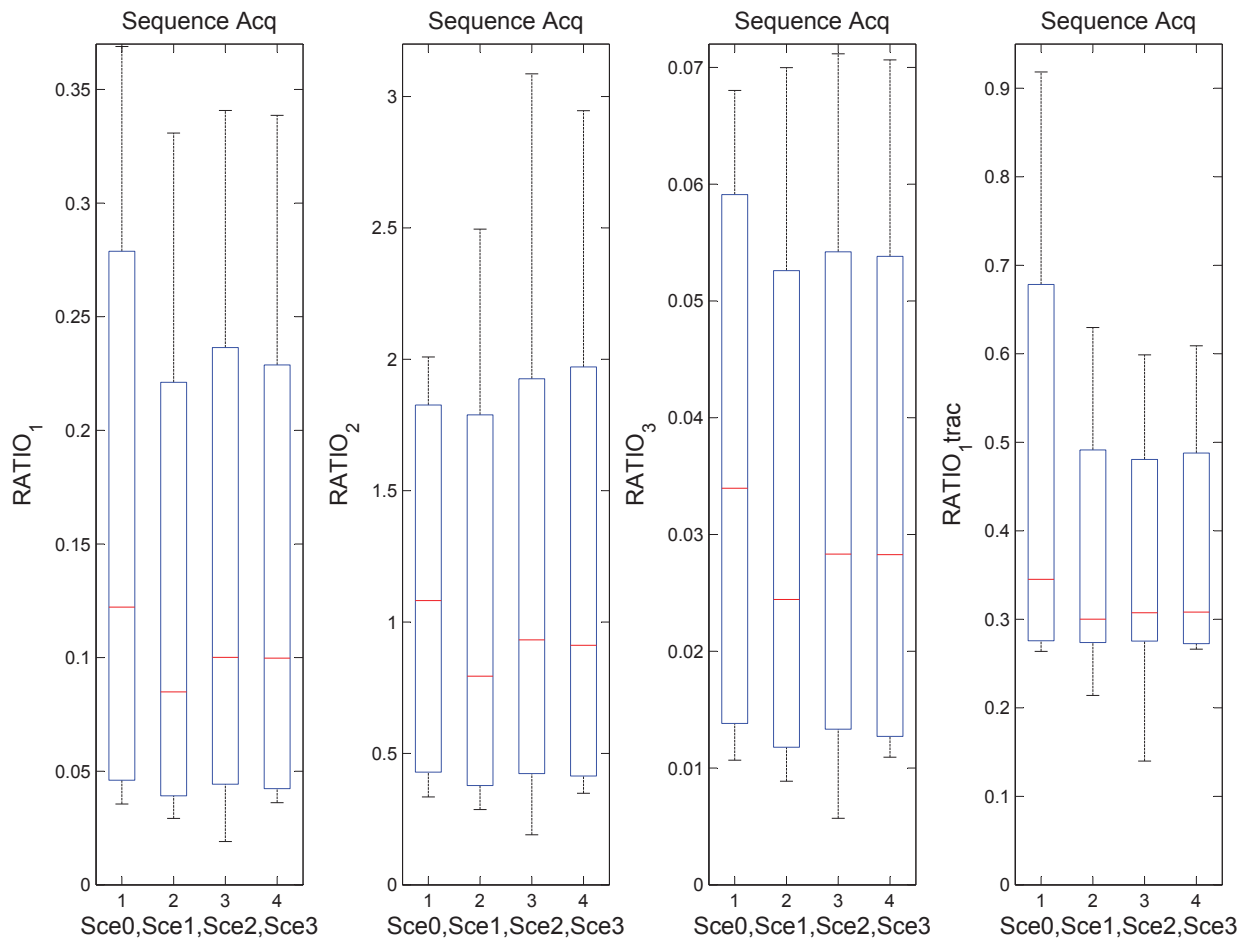

Fig. 8. Median and quartiles for $Ratio_1$, $Ratio_2$, $Ratio_3$ and $Ratio_{1trac}$ for acquisition situation

4.3 If-then rules

If-then rules have been defined to obtain the best performance (in terms of reliability of the output variable *Acquisition* of the fuzzy estimator) along the full range of measured values for each input parameter. Two examples of the dependence between input variables are shown in Figure 14, where dependence among *Acquisition* and $Ratio_1$ and $Ratio_{1trac}$, and also $Ratio_2$ and $Ratio_3$ are depicted.

The most critical estimation for the output variable *Acquisition* is the correspondence to **Probably Not Acquired** and to **Probably Acquired**; this means that the input parameters have no coherent values for **Acquired** or **Not Acquired**. To obtain a precise output value, the fuzzy estimator evaluates the degree of implication of each input parameter to the input variables membership functions and projects this implication to the fuzzy sets of the output variable *Acquisition*, in order to obtain its final value through defuzzification.

4.4 Decisional system feedback

Depending on the value of the output variable *Acquisition*, the multiresolutive acquisition block will perform in four different ways:

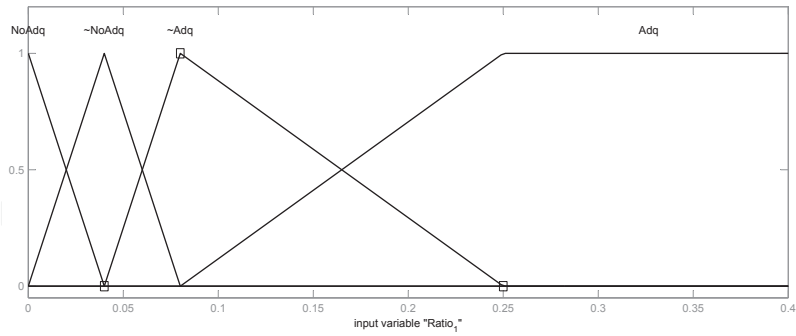

Fig. 9. Membership functions for input variable $Ratio_1$

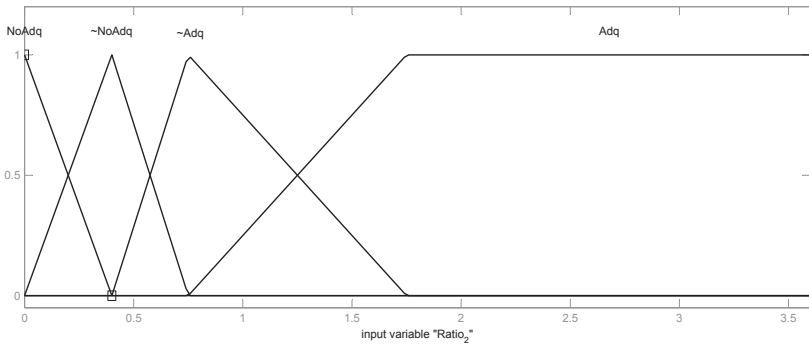

Fig. 10. Membership functions for input variable $Ratio_2$

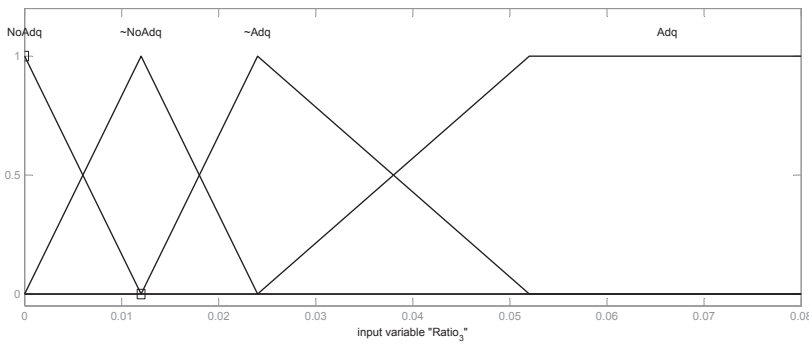

Fig. 11. Membership functions for input variable $Ratio_3$

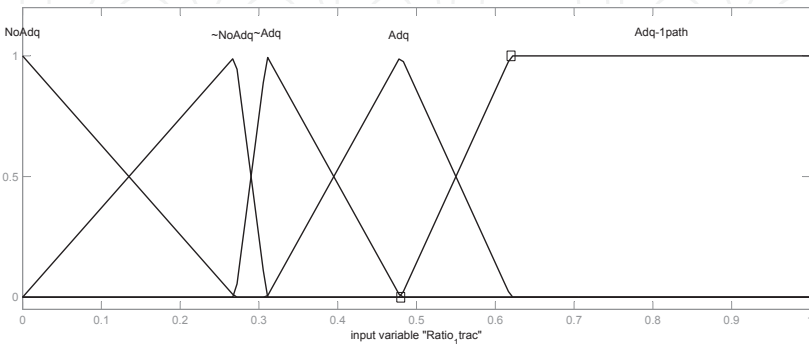

Fig. 12. Membership functions for input variable $Ratio_{1trac}$

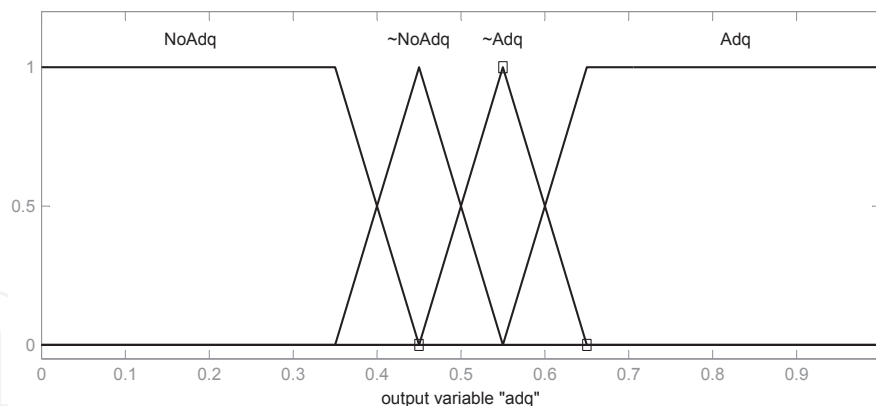
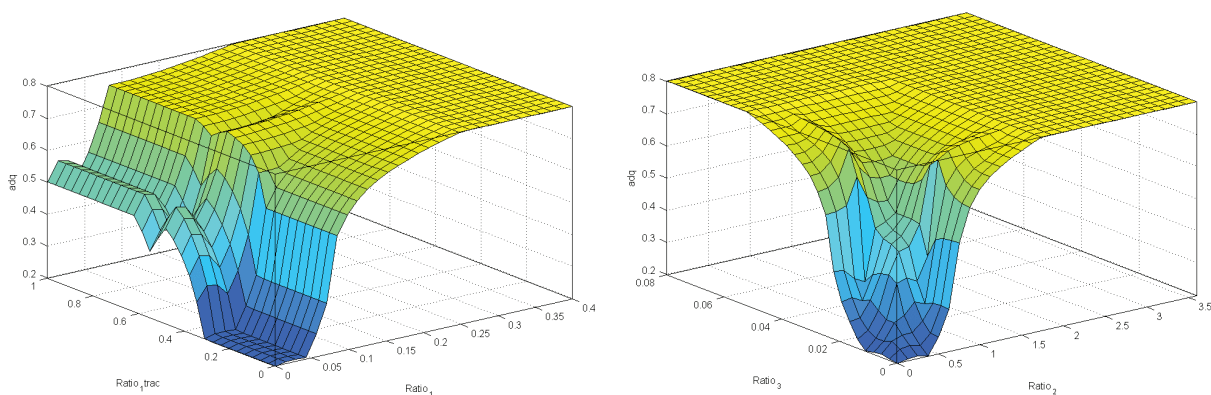

Fig. 13. Membership functions of *Acquisition*



(a) *Acquisition* as a function of $Ratio_1$ and $Ratio_{1trac}$ (b) *Acquisition* as a function of $Ratio_2$ and $Ratio_3$

Fig. 14. Two examples of the variation of output variable *Acquisition* for all the whole range of values of the two ratios, taken by pairs.

- **Acquired**, it maintains the acquired position, saving computational load by stopping some of the adaptive filters used in the acquisition stage. This helps the structure to reduce its computational load. The ratios are computed only for the active filters, and each pause period (fixed to a certain number of symbol periods) ends with a convergence of all the filters, and a recalculation of all the ratios in order to prevent losing acquisition.
- **Probably Acquired**, it keeps the searching procedure to improve acquisition, and of course, evaluations are maintained until the convergence is certain - if this is the case.
- **Probably Not Acquired**, move $\frac{T_s}{4}$ the beginning of the data for the acquisition stage and evaluate improvements; this pointer movement is used to prevent the system from failing in its purpose due to a bad initial pointer position. Not all the initial values are equally convenient for the multiresolutive structure; the optimum situation is when the acquisition point is found in the middle of any of the four adaptive filters, and this approach helps the convergence if the position is not the optimum, despite convergence is possible at any tap of the four LMS filters.
- **Not Acquired**, move $\frac{T_s}{2}$ and evaluate to find changes. The move of $\frac{T_s}{2}$ is larger than in the previous case because if the system is in an *not acquired* situation, it means that the acquisition is far to be detected, so the initial data for the acquisition stage can be found in

the worst place - the one that obtains the acquisition point far from the center of the LMS filters -.

These four categories are chosen depending on the *Acquisition* output variable values. This feedback improves the speed of convergence of the acquisition and reduces computational load for the entire structure, by means of stopping the convergence of some of the adaptive filters when convergence is assured.

5. Tests and results

In this Section the results of the performance of the designed fuzzy system are presented. First, an evaluation of the performance of the fuzzy control set designed is shown, evaluating the estimation reliability of the variable *Acquisition* against the true receiver state at every simulation time. The second evaluation devoted to study the whole multiresolutive structure performance. The results for the fuzzy multiresolutive structure are compared with the previously presented multiresolutive structure with a stability control (Morán et al., 2001).

Tests have been made using the four scenarios described in Section 4.1.2.1; in all simulations the same 128 chip PN sequence, obtained using an evolutionary strategy has been used (Alsina et al., 2007a). In each test (for a certain SNR and a certain scenario) 600 symbols length data sequences have been used, and ten repetitions have been simulated using different channel initialization; the presented results are the mean of all these evaluations.

5.1 Evaluation of the control system performance

In the evaluation of the control system performance three variables have been measured. The first is the % of correct acquisition estimations, comparing the *Acquisition* value with the a posteriori measured probability of being acquired. The second is the % of incorrect acquisition estimations, but only for the optimistic ones; this means to evaluate when the fuzzy control system estimates the multiresolutive structure is acquired (assuming this is when *Acquisition* variable value is over 0.5), and the system real estimation of the acquisition position is incorrect. The last one is the % of incorrect acquisition estimation, but only for the pessimistic ones; this means to evaluate when the fuzzy control system estimates the multiresolutive structure is not acquired (assuming this is when *Acquisition* variable is under 0.5), and the system real estimation of the acquisition point is correct.

In Figure 15 these measurements are depicted. As shown in Figure 15.a, the % of correct fuzzy acquisition estimations perform good values, near 100%, except for the range of [-38,-35] dB, where all four scenarios present hit values of around 20%. This is due to a threshold SNR value, where the ratios make confusing evaluations due to the high level of noise. But this fact is temporary, because when the SNR worsens, the ratios evaluated make the fuzzy system converge to the correct evaluation; however, in this case quite a lot of evaluations are for **Not Acquired**.

The error performance evaluations are shown in Figures 15.b and 15.c. These figures outstand that most of the incorrect evaluations are for the system output indicating **Not Acquired** when the system is really **Acquired**. They also show that the *optimistic* incorrect estimations are really better than those related to the *pessimistic* ones. These results are the main indicators of a good system robustness: the system remotely considers *Acquisition* wrongly, so the information detection process works only for the correct *Acquisition* situations. Although this

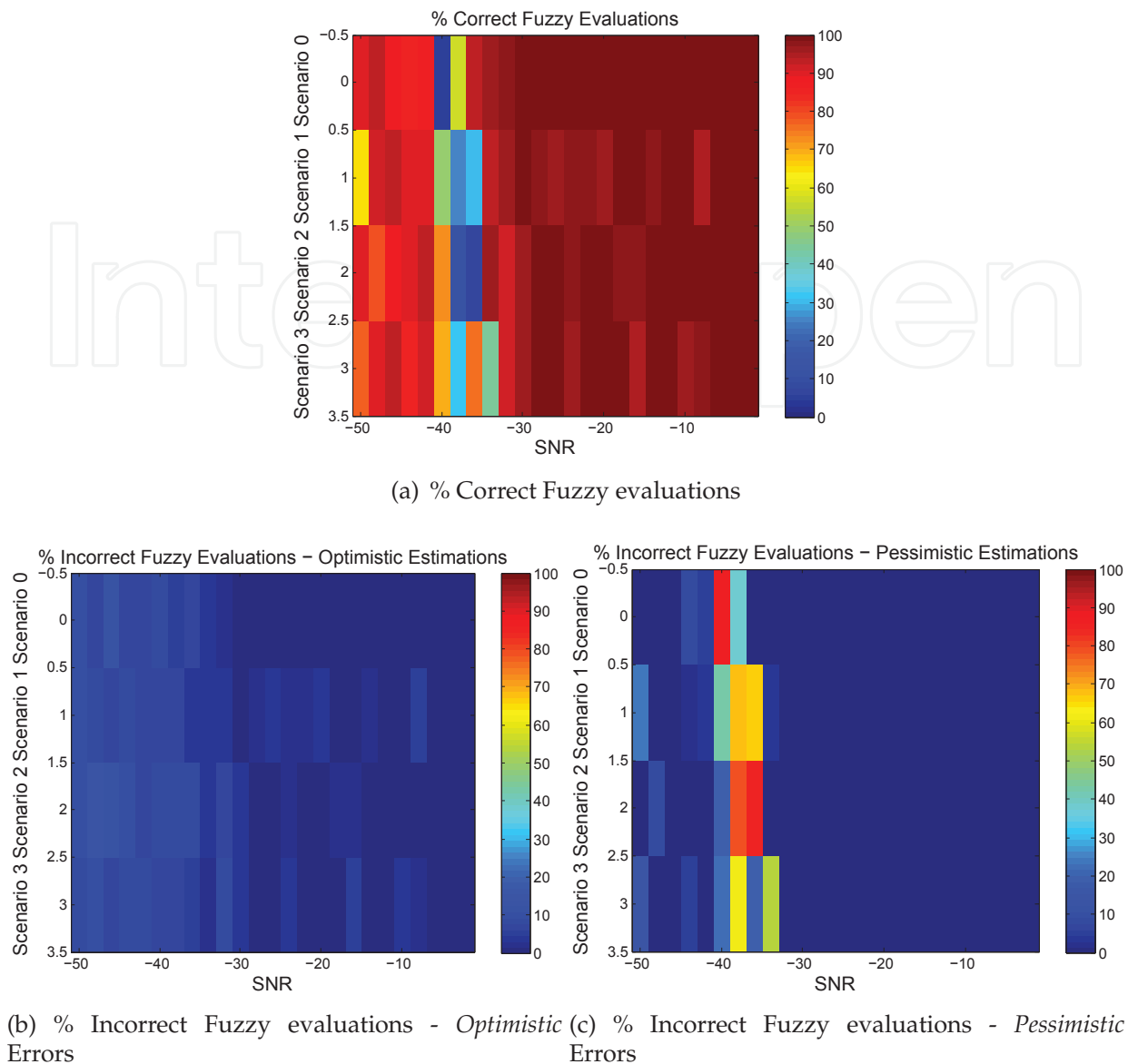

Fig. 15. Performance of the Fuzzy Logic Control. Measurements about the correct and incorrect evaluations.

factor, it must be taken into account that some bad estimations (*pessimistic* ones) prevent the system from obtaining better information ratios in certain ranges of SNR [-38,-35] dB.

5.2 Evaluation of the Fuzzy Multiresolutive Acquisition vs. the Multiresolutive Structure

The evaluation of the Fuzzy Multiresolutive Acquisition structure vs. the Multiresolutive Structure (Morán et al., 2001) is based on the comparison of the *Acquisition* estimation evaluated for both systems, obviously using the same channel conditions for the two systems.

5.2.1 The stability control for the Multiresolutive Structure

The Multiresolutive Structure presented by (Morán et al., 2001) works with a stability control. This control is based on the robustness of the filter convergence, using it as a premise for its

design. The stability control gives an output **Acquired** if the adaptive filter structure presents the same results for a certain number of times (in this case, three times). In the work of (Morán et al., 2001) it is shown that the probability of being acquired increases as the acquisition position is more stable, and the stability control is based in this principle. The problems of the performance of this kind of stability control solution are lack of robustness in low SNR environments, interference and fading, and of course, multipath, because it cannot recognize a correct acquisition situation immediately; it was designed for enhance stability, so it keeps a **Not Acquired** output until the acquisition position is stable again.

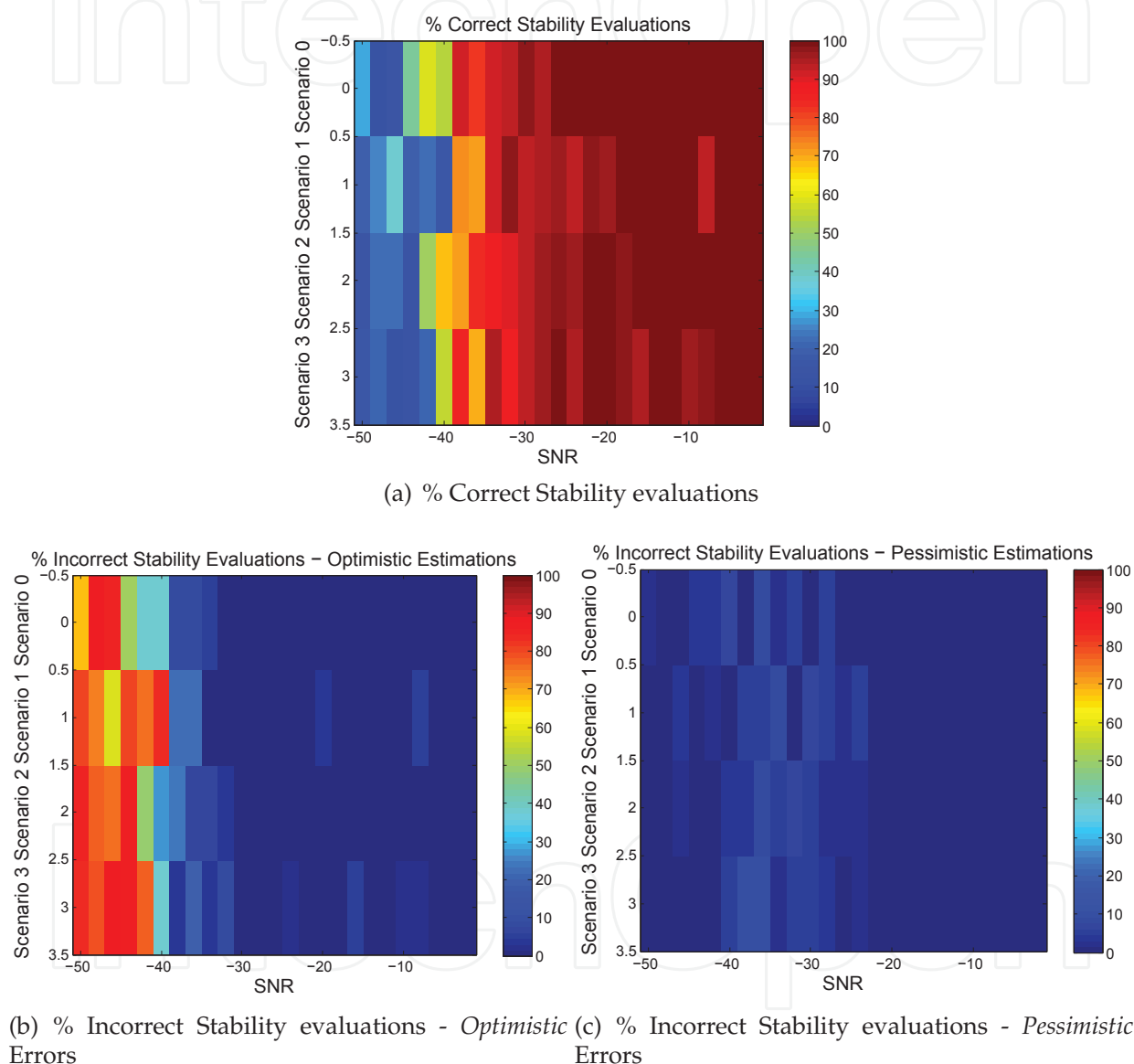

Fig. 16. Performance of the Stability Control. Measurements about the correct and incorrect evaluations.

This lack of robustness is improved with the design of the fuzzy control system, because its estimation uses various instantaneous parameters, so reacquisition is faster; the fact of relying on four different parameters ensures the robustness of the system, despite instantaneous non convergence situations for the LMS filters.

The results for the stability control solution are shown in Figures 16. Figure 16.a shows the correct performance of the stability control, and Figures 16.b and 16.c show the performance for the incorrect stability evaluations, the first for the optimistic errors, and the second one for the pessimistic. Figure 16.b depicts high optimistic error, which deal to the multiresolutive structure to assume acquisition when it is not. This fact globally increases the BER at the receiver in terms of confidence in the demodulation of the information.

5.2.2 Comparison results

In this Section a comparative analysis of the results of the fuzzy and the stability controls is made. Numerical results for the four scenarios are computed, and the mean of these results is taken into account to compare the two control systems.

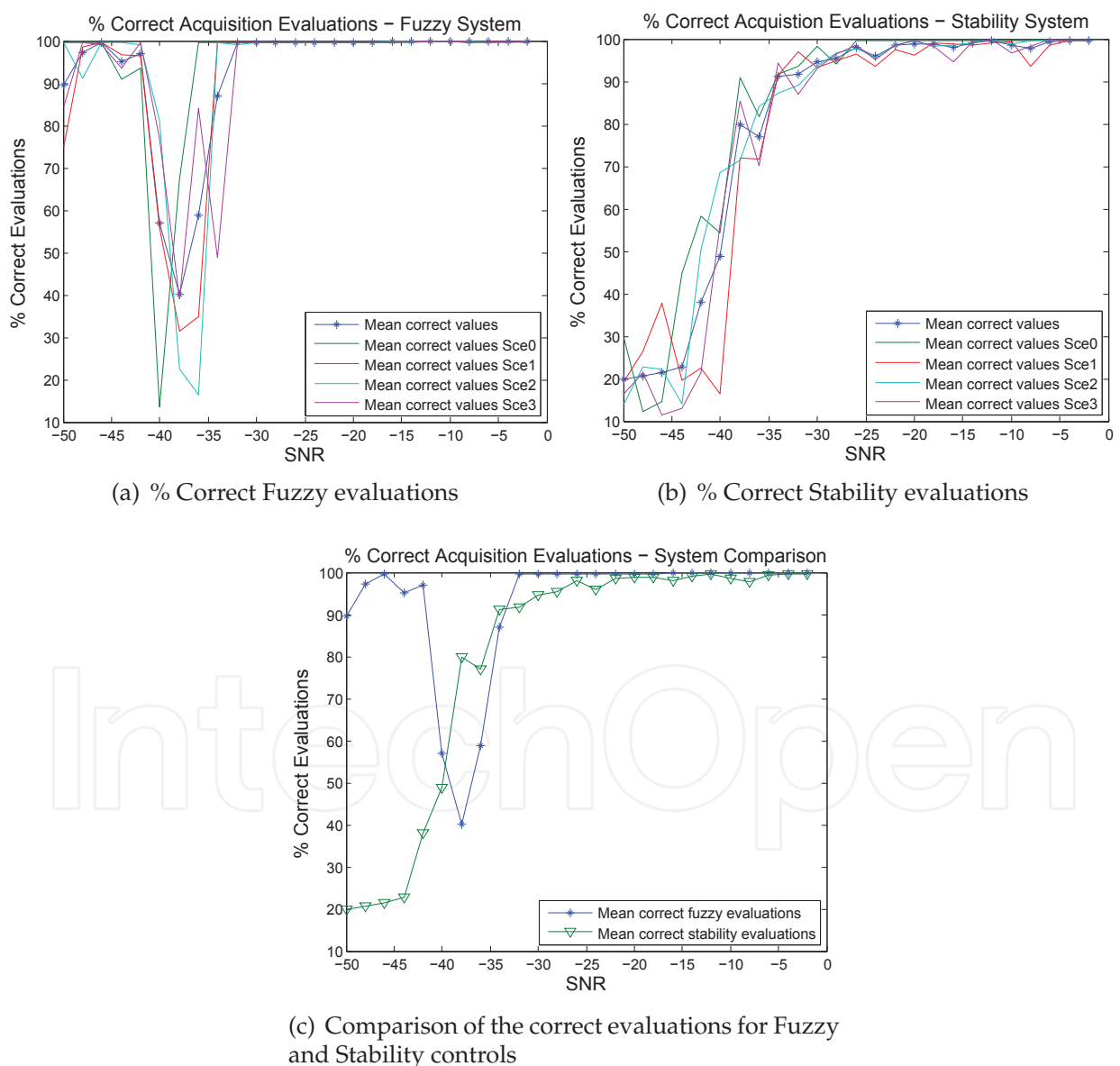
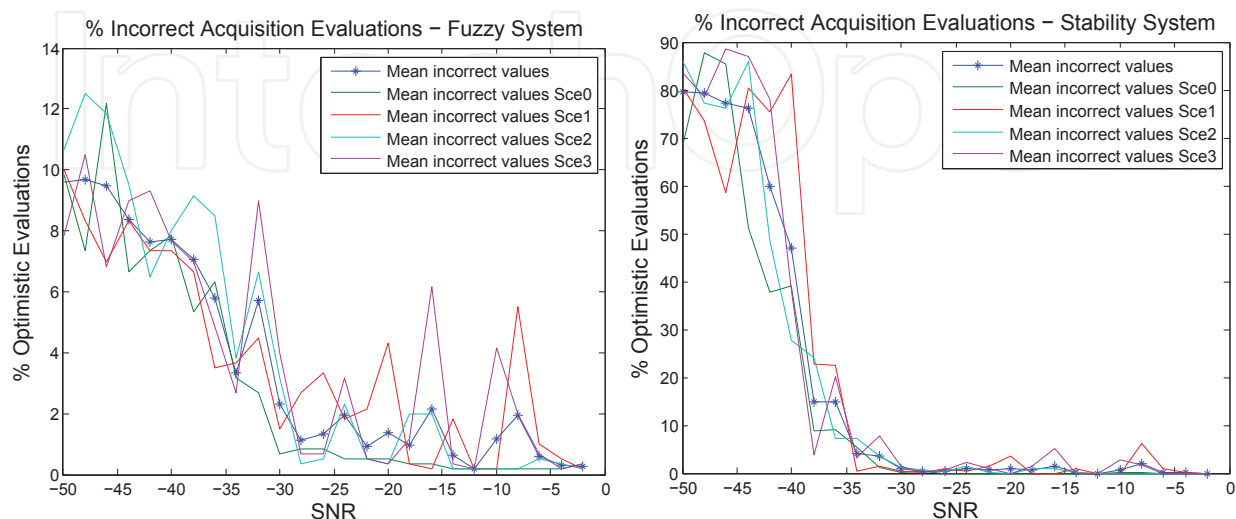
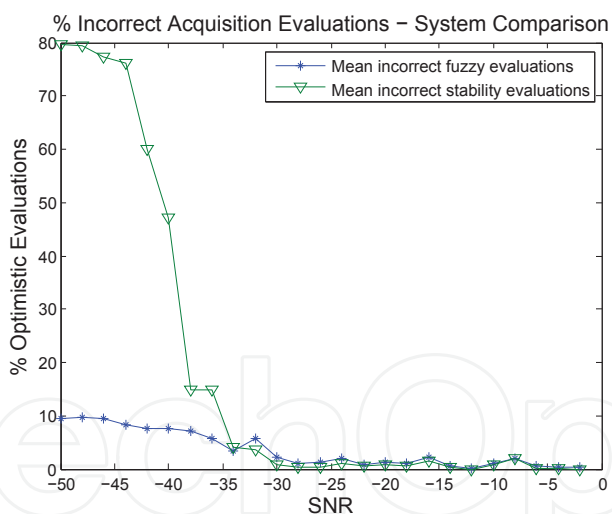

Fig. 17. Comparison of the correct evaluations for both fuzzy and stability controls.

In Figure 17 an analysis of the performance for the correct estimation for both controls is done. In Figure 17.c the comparison for both is made in terms of %. The fuzzy control performs better for each SNR value except for the range [-38,-35] dB, where it performs worse, despite the lowest SNR values back to get into a proper operation. It has to be noticed that the stability control starts performing bad around -37 dB, and does not recover for worse SNR.



(a) % Incorrect *Optimistic* Fuzzy Control system evaluations (b) % Incorrect *Optimistic* Stability Control system evaluations



(c) Comparison of the incorrect *Optimistic* evaluations for Fuzzy and Stability Controls

Fig. 18. Comparison of the incorrect evaluations for both fuzzy and stability controls, in case that the error is *optimistic*.

Figure 18 shows the incorrect optimistic evaluations for both fuzzy and stability controls. Optimistic error is very low for fuzzy control at any SNR (see Figure 18.a), and for stability control is just the opposite: it has very high optimistic error, especially for lower SNR (see Figure 18.b, and 18.c for a comparison between the two control systems). Then, the use of the stability control makes the multiresolutive structure be confident in the information

demodulation of the system when it is really not correctly acquired, and BER increases in the receiver.

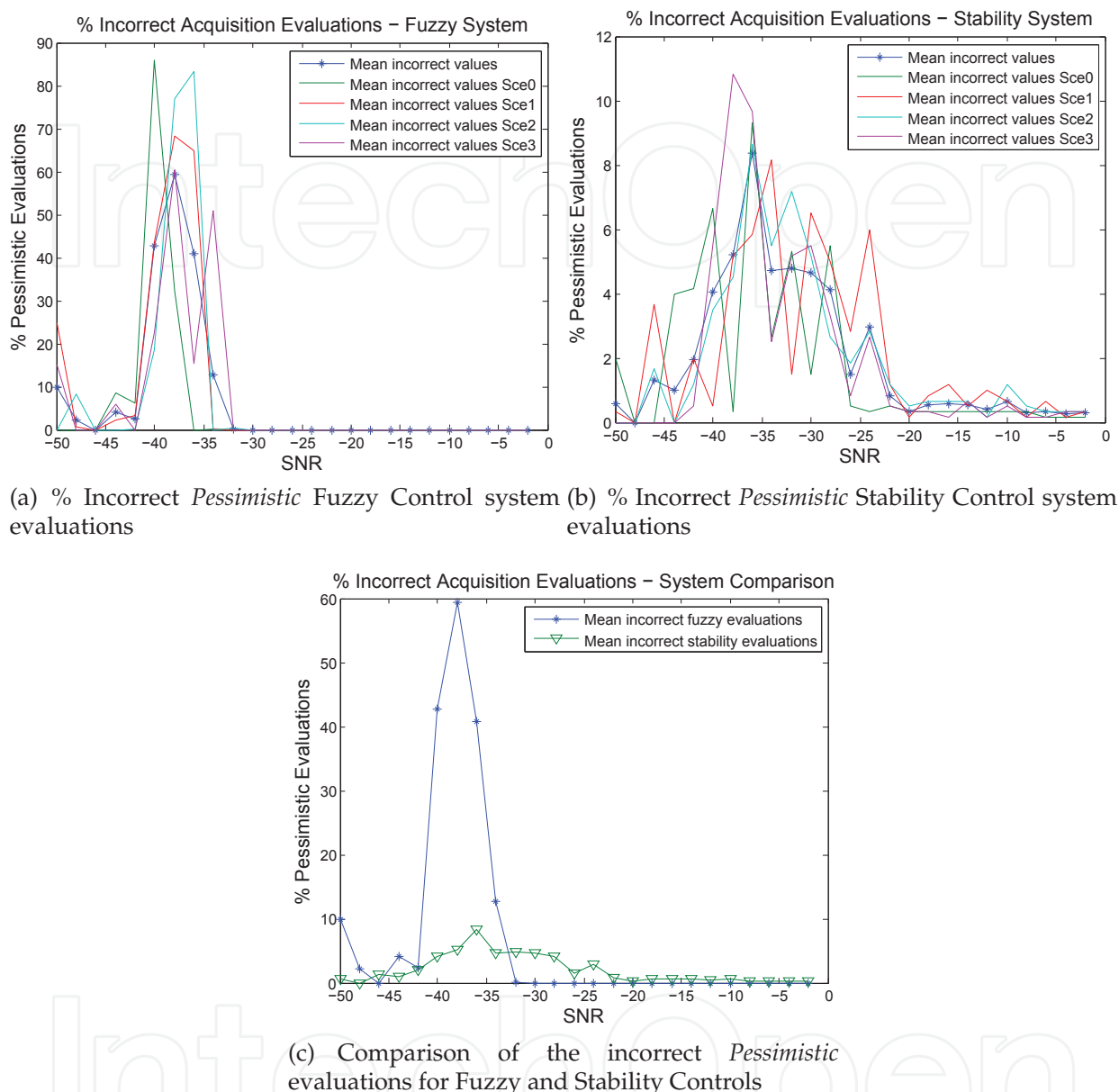

Fig. 19. Comparison of the incorrect evaluations for both fuzzy and stability controls, in case that the error is *pessimistic*.

In Figure 19 the pessimistic error for both controls is shown. In this case, Figure 19.a depicts a bad performance of the fuzzy control system for values ranging $[-38, -35]$ dB, but its performance becomes better when SNR worsen. Figure 19.b outstands a more constant performance for the stability control in the case of the pessimistic error.

5.3 Multiresolutive structure acquisition feedback

Finally, the possibilities of improving the performance of the multiresolutive structure (Morán et al., 2001) are shown through visualization of the output *Acquisition* behavior for the fuzzy

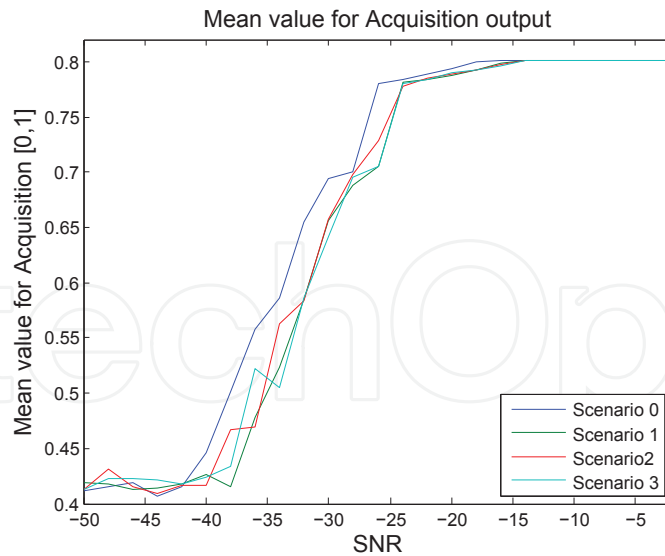

Fig. 20. Mean output *Acquisition* values for the four scenarios

control system. The most important advantage of fuzzy logic vs. a stability control is that the quality of the acquisition can be measured; for high values of *Acquisition*, the performance of the system is better, for lower, the convergence is not guaranteed.

In Figure 20 the mean values of output variable *Acquisition* of the fuzzy control system are shown (each value is computed for a specific scenario and SNR). This figure shows the information that the fuzzy control gives to the decisional system of the multiresolutive structure. At first, it is used to set the convergence (see the details in Section 4.4). If the value of *Acquisition* is higher than 0.75, the convergence is nearly guaranteed, and the system does not need to run all the adaptive filters at each symbol time. If the value of *Acquisition* is between 0.5 and 0.75, the system is **Probably Acquired**, but keeps searching to improve acquisition. But if *Acquisition* is between 0.25 and 0.75, the decisional system moves the data for the acquisition stage by $\frac{T_s}{4}$, and evaluates the improvement of the convergence of the filters. Finally, if the *Acquisition* value is lower than 0.25, the decisional system moves the data for the acquisition stage by $\frac{T_s}{2}$ and evaluates the convergence improvement. In the current simulations, although some of the outputs for *Acquisition* were lower than 0.25, the values of the SNR tested mean *Acquisition* were evaluated over 0.4.

The second advantage of using continuous output values for the *Acquisition* variable is reducing computational load by stopping the search - filters LMS adaptation - during acquisition state. Nearly $\frac{3}{4}$ of the computational load of the LMS filters can be reduced in case of certain acquisition (shown through variable *Acquisition* value over 0.75) for SNR values ranging [-20,0] dB approximately, while this is not possible to be done using a stability control.

5.4 Summary

In this section, the evaluation results have been shown for the performance of the fuzzy logic controller in the multiresolutive acquisition structure. The fuzzy logic control system shows good performance even for low SNR, except for the values in the range [-38,-35]dB; in this range the estimation error increases due to *pessimistic* errors. In comparison with the stability control, the global behavior is improved because the fuzzy control has better results above

the critical margin of [-38,-35]dB, and it behaves really well for lower SNR. Another clear advantage of the fuzzy control against the stability control is the wider range of possible output values. This fact allows the multiresolutive structure to decrease its computational load when the system is clearly acquired, and also to change the acquisition pointer in case of a far acquisition estimated point; this information enhances the receiver performance, not only in terms of reliability, but also in terms of computational load.

6. Conclusions

In this chapter a novel fuzzy control system for a multiresolutive acquisition structure (Morán et al., 2001) is detailed. It can be concluded that the four computed ratios used as input values for the control system ($Ratio_1$, $Ratio_2$, $Ratio_3$ and $Ratio_{1trac}$) perform coherently with the results of the multiresolutive structure. Therefore, decisions can be made attending to their values. It can be stated that these ratios stand out for the performance of the whole system, and their values for the four simulated scenarios are found in the same range of values. Therefore, we conclude that they might be useful to describe and optimize the system performance.

The fuzzy logic control gives a more precise output acquisition variable allowing the system to conclude whether it is correctly acquired, probably acquired, probably not acquired, and not acquired; then, the control logic can optimize the computational load of the structure depending on these values. If the system is correctly acquired (depending on the value for *Acquisition*), the decisional system reduces the global computational load by stopping the convergence of some LMS adaptive filters (despite the detailed computational load study is not included in this chapter). So, not only the acquisition estimation is improved, but also the global performance of the structure is optimized. The only SNR range where the fuzzy control system performance can significantly be improved is around [-40,-35] dB, where this performance is poor. It is also important to note that the correct estimation of the acquisition for very low SNR values helps the system in terms of confidence about the demodulated information; in case of the stability control, for values worse than -36 dB the information demodulated is notoriously unreliable; and for fuzzy control, *Acquisition* continuous value gives enough information to know whether the system is out of the correct acquisition area, and hence the system not being confident on the information results. Future research is focused in improving the performance of the fuzzy control in the multiresolutive structure, especially at specific levels of SNR where the results behavior is pessimistic, in order to increase the reliability of the system estimation.

The results shown in this chapter stand out for the application of fuzzy control systems to other acquisition schemes found in the literature, and allow us to state that our work represents an interesting proposal to the future research in this field; the LMS adaptive scheme presented by (El-Tarhuni & Sheikh, 1996), lately improved by (Han et al., 2006), and also the adaptive system for ocean acquisition transmission presented by (Stojanovic & Freitag, 2003). We think that the knowledge of the channel characteristics and the behavior of the LMS filter convergence would be the first data to be taken into account to the design a fuzzy control system conceived with the aim of improving the stability and the robustness of any acquisition receiver for a DS-SS communications system. This aspect is highlighted here, because control systems designed to operate within LMS-based adaptive acquisition schemes found in the literature do not consider other information rather than the stability of the acquisition estimation.

7. Acknowledgments

This work has been funded by the Spanish Government under the projects REN2003-08376-C02-02, CGL2006-12437-C02-01/ANT, CTM2008-03236-E/ANT, CTM2009-13843-C02-02 and CTM2010-21312-C03-03. La Salle thanks the *Comissionat per a Universitats i Recerca del DIUE de la Generalitat de Catalunya* for their support under the grant 2009SGR459. We must also acknowledge the support of the scientists of the Observatory de l'Ebre throughout the research work.

8. References

- Akhter, N., Ferdouse, L., Jaigirdar, F. & Nipa, T. (2010). A Performance Analysis of LMS, RLS and Lattice based Algorithms as Applied to the Area of Linear Prediction, *Journal of Global Research in Computer Science* 1: 49–53.
- Alsina, R., Bernadó, E. & Morán, J. (2005b). Evolution Strategies for DS-CDMA Pseudonoise Sequence Design, *Frontiers in Artificial Intelligence and Applications - Artificial Intelligence Research and Development* 131: 189 – 196. IOS Press.
- Alsina, R. M., Bergadà, P., Socoró, J. C. & Deumal, M. (2009a). Multiresolutive Acquisition Technique for DS-SS Long-Haul HF Data Link, *Proceedings of the 11th Ionospheric Radio Systems and Techniques (IRST)*, IET, Edimburgh (Regne Unit).
- Alsina, R. M., Formiga, L., Socoró, J. C. & Bernadó, E. (2007a). Multiobjective Evolution Strategies for DS-CDMA Pseudonoise Sequence Design in a Multiresolutive Acquisition, *Frontiers in Artificial Intelligence and Applications - Artificial Intelligence Research and Development* 163: 384 – 391. IOS Press.
- Alsina, R. M., Mateo, C., Socoró, J. C. & Deumal, M. (2008). Neural Network Acquisition Estimator for Multiresolutive Adaptive PN Acquisition Scheme in Multiuser Non Selective Fast SNR Variation Environments, *8th International Conference on Hybrid Intelligent Systems (HIS)*, Barcelona (Espanya).
- Alsina, R., Mateo, C. & Socoró, J. (2007b). Multiresolutive Adaptive PN Acquisition Scheme with a Fuzzy Logic Estimator in Non Selective Fast SNR Variation Environments, *Lecture Notes in Computer Science - Springer Verlag* 4507: 367 – 374. International Work-conference on Artificial Neural Networks (IWANN).
- Alsina, R., Mateo, C. & Socoró, J. (2009b). *Artificial Intelligence Enciclopaedia*, IGI Global, (EUA), chapter 'F': Fuzzy Logic Estimator for Variant SNR Environments, pp. 719–728.
- Alsina, R., Morán, J. & Socoró, J. (2005a). Sequential PN Acquisition Scheme Based on a Fuzzy Logic Controller, *Lecture Notes in Computer Science - Springer Verlag* 3512: 1238 – 1245. International Work-conference on Artificial Neural Networks (IWANN).
- Bas, J. & Perez-Neira, A. (2003). A Fuzzy Logic System for Interference Rejection in Code Division Multiple Access, *IEEE International Conference on Fuzzy Systems* 2: 996–1001.
- Bergadà, P., Deumal, M., Alsina, R. & Pijoan, J. (2009). Time Interleaving Study for an OFDM Long-Haul HF Radio Link, in T. IET (ed.), *Proceedings of the 11th Ionospheric Radio Systems and Techniques*, Edimburgh (UK).
- Daffara, F. (1995). A Fuzzy Rule Based Phase Error Detector, *Proceedings of URSI International Symposium on Signals, Systems, and Electronics*.
- Deumal, M., Vilella, C., Socoró, J., Alsina, R. & Pijoan, J. (2006). A DS-SS Signaling Based System Proposal for Low SNR HF Digital Communications, *IEEE International Conference on Ionospheric Radio Systems and Techniques*, IEEE, London, UK.

- Drake, J. & Prasad, N. (1999). Current Trends Towards Using Soft Computing Approaches to Phase Synchronisation in Communications Systems, *IEEE 42nd Midwest Symposium on Circuits and Systems*.
- El-Tarhuni, M. & Sheikh, A. (1996). MSE Tracking Performance of DS-SS Code Tracking Scheme Using an Adaptive Filter, *Electronic Letters* 32: 1543–1545.
- Gad, A. & Farouq, M. (2001). Applications of Fuzzy Logic in Engineering Problems, *Proceedings of the Annual Conference of IEEE Industrial Electronics Society*.
- Glisic, S. G. (1991). Automatic Decision Threshold Level Control in Direct Sequence Spread Spectrum Systems, *IEEE Transactions on Communications* 39(2): 519–527.
- Glisic, S. & Vucetic, B. (1997). *Spread Spectrum CDMA Systems for Wireless Communications*, Artech House Publishers, United States of America.
- Han, M., Yu, T., Kang, C. & Hong, D. (2006). A New Adaptive Code-Acquisition Algorithm Using Parallel Subfilter Structure, *IEEE Transactions on Vehicular Technology* 55(6): 1790–1796.
- Haykin, S. (1996). *Adaptive Filter Theory*, Prentice Hall International, United States of America.
- Morán, J., Socoró, J., Jové, X., Pijoan, J. & Tarrés, F. (2001). Multiresolution Adaptive Structure for acquisition in DS-SS receivers, *International Conference on Acoustics, Speech and Signal Processing*.
- Perez-Neira, A. & Lagunas, M. (1996). High Performance DOA Trackers Derived from Parallel Low Resolution Detectors, *IEEE Workshop on SSAP*.
- Perez-Neira, A., Lagunas, M. & Bas, J. (1997). Fuzzy Logic for Robust Detection in Wireless Communications, *Proceedings of the 8th IEEE International Symposium on Personal, Indoor and Mobile Radio Communications*.
- Peterson, R., Ziemer, R. & Borth, D. (1995). *Introduction to Spread Spectrum Communications*, Prentice Hall, United States of America.
- Proakis, J. (1995). *Digital Communications*, McGraw-Hill, Singapore.
- Sklar, B. (1988). *Digital Communications, Fundamentals and Applications*, Prentice Hall International, United States of America.
- Stojanovic, M. & Freitag, L. (2003). Acquisition of Direct Sequence Spread Spectrum Acoustic Communication Signals, *Oceans* 1: 279 – 286.
- Vilella, C., Miralles, D., Altadill, D., Acosta, F., Sole, J., Torta, J. M. & Pijoan, J. (2009). Vertical and Oblique Ionospheric Soundings over a Very Long Multihop HF Radio Link from Polar to Midlatitudes: Results and Relationships, *Radio Science* 44.
- Vilella, C., Miralles, D. & Pijoan, J. (2008). An Antarctica-to-Spain HF ionospheric radio link: Sounding results, *Radio Sci.* 43(doi:10.1029/2007RS003812).
- Zadeh, L. (1965). Fuzzy Sets, *IEEE Transactions on Information and Control* 8: 338–353.
- Zadeh, L. (1988). Fuzzy Logic, *Computer* 21(4): 83–92.

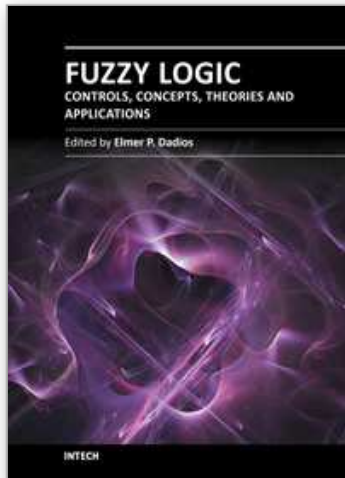

Fuzzy Logic - Controls, Concepts, Theories and Applications

Edited by Prof. Elmer Dadios

ISBN 978-953-51-0396-7

Hard cover, 428 pages

Publisher InTech

Published online 28, March, 2012

Published in print edition March, 2012

This book introduces new concepts and theories of Fuzzy Logic Control for the application and development of robotics and intelligent machines. The book consists of nineteen chapters categorized into 1) Robotics and Electrical Machines 2) Intelligent Control Systems with various applications, and 3) New Fuzzy Logic Concepts and Theories. The intended readers of this book are engineers, researchers, and graduate students interested in fuzzy logic control systems.

How to reference

In order to correctly reference this scholarly work, feel free to copy and paste the following:

Rosa Maria Alsina-Pages, Claudia Mateo Segura, Joan Claudi Socoró Carrié and Pau Bergada (2012). Fuzzy Logic Control for Multiresolutive Adaptive PN Acquisition Scheme in Time-Varying Multipath Ionospheric Channel, Fuzzy Logic - Controls, Concepts, Theories and Applications, Prof. Elmer Dadios (Ed.), ISBN: 978-953-51-0396-7, InTech, Available from: <http://www.intechopen.com/books/fuzzy-logic-controls-concepts-theories-and-applications/fuzzy-logic-control-for-multiresolutive-adaptive-pn-acquisition-scheme-in-time-varying-multipath-ion>

INTECH

open science | open minds

InTech Europe

University Campus STeP Ri
Slavka Krautzeka 83/A
51000 Rijeka, Croatia
Phone: +385 (51) 770 447
Fax: +385 (51) 686 166
www.intechopen.com

InTech China

Unit 405, Office Block, Hotel Equatorial Shanghai
No.65, Yan An Road (West), Shanghai, 200040, China
中国上海市延安西路65号上海国际贵都大饭店办公楼405单元
Phone: +86-21-62489820
Fax: +86-21-62489821

© 2012 The Author(s). Licensee IntechOpen. This is an open access article distributed under the terms of the [Creative Commons Attribution 3.0 License](#), which permits unrestricted use, distribution, and reproduction in any medium, provided the original work is properly cited.

IntechOpen

IntechOpen