

We are IntechOpen, the world's leading publisher of Open Access books Built by scientists, for scientists

4,800

Open access books available

122,000

International authors and editors

135M

Downloads

Our authors are among the

154

Countries delivered to

TOP 1%

most cited scientists

12.2%

Contributors from top 500 universities



WEB OF SCIENCE™

Selection of our books indexed in the Book Citation Index
in Web of Science™ Core Collection (BKCI)

Interested in publishing with us?
Contact book.department@intechopen.com

Numbers displayed above are based on latest data collected.
For more information visit www.intechopen.com



Fuzzy Control System Design and Analysis for Completely Restrained Cable-Driven Manipulators

Bin Zi^{1,2}

¹*School of Mechanical and Electrical Engineering,*

China University of Mining and Technology, Xuzhou, Jiangsu,

²*The State Key Laboratory of Fluid Power and Mechatronic Systems,*

Zhejiang University, Hangzhou, Zhejiang

China

1. Introduction

Cable-driven manipulators, referred to as the overhead crane and rotary crane are widely used in the manufacturing and construction industries in order to move heavy objects as illustrated in Fig. 1. Cable-driven manipulators are relatively simple form, with multiple cables attached to a mobile platform or end-effector. The end-effector may be equipped with various attachments, including hooks, cameras, robotic grippers and so on. Cable-driven manipulators have several advantages over rigid-link mechanisms, including the following: 1) remote location of motors and controls; 2) rapid deployability; 3) potentially large workspaces; 4) high load capacity; 5) reliability (Borgstrom et al., 2009; Zi et al., 2008). For the preceding reasons, cable-driven manipulators have received attention and have been recently studied since 1980s (Behzadipour & Khajepour, 2005; Ghasemi et al., 2008; Motoji, 2004; Oh & Agrawal, 2005; Pham et al., 2006).



Fig. 1. Crane-type cable manipulator.

Cable-driven manipulators can be classified as either incompletely restrained or completely restrained (Bosscher & Ebert-Uphoff, 2006). Cable-driven manipulators are underconstrained if it relies on gravity to determine the pose (position and orientation) of the end-effector, while they are completely restrained if the pose of the end-effector is completely determined by the lengths of the cables. As you know, dynamics is a huge field of study devoted to studying the forces required to cause motion. In order to accelerate the robot from rest, glide at a constant end-effector velocity, and finally decelerate to a stop, a complex set of torque functions must be applied by the joint actuators (Craig, 2005). The motivation for this paper comes directly from the design, mechanics analysis, and control of completely restrained cable-driven manipulators (CRCM) with 3 Degrees of Freedom (DOF). As demonstrated in (Anupoju et al., 2005), servomechanism dynamics constitute an important component of the complete robotic dynamics. Therefore, the dynamics of the servomotors and its gears must be modeled for further control design. However, the literature on the CRCM system including the actuator dynamics is sparse.

CRCM systems are multivariable in nature. The control of the multivariable systems is a complicated problem due to the coupling that exists between the control inputs and the outputs, and the multivariable systems are nonlinear and uncertain, therefore, their control problem becomes more challenging (Chien, 2008; Yousef et al., 2009). In order to achieve a high-precision performance, the controller of the CRCM must effectively and accurately manipulate the motion trajectory. It is well known that up until now, a conventional proportional-integral-derivative (PID) controller has been widely used in industry due to its simple control structure, ease of design, and inexpensive cost (Reznik et al., 2000; Visioli, 2001). However, the CRCM is a multivariable nonlinear coupling dynamic system which suffers from structured and unstructured uncertainties such as payload variation, external disturbances, etc. As a result, the PID controller cannot yield a good control performance for this type of control system. For dealing with nonlinear effects, various control algorithms have been proposed. Among them, adaptive control and fuzzy logic system algorithm draw much attention due to the applicability for typically highly nonlinear systems (Chang, 2000; Soyguder & Alli, 2010; Su & Stepanenko, 1994). The idea of fuzzy set and fuzzy control is introduced by Zadeh in an attempt to control systems that are structurally difficult to model (Feng, 2006; Zadeh, 1965). Fuzzy controllers have been well accepted in control engineering practice. The major advantages in all these fuzzy-based control schemes are that the developed controllers can be employed to deal with increasingly complex systems to implement the controller without any precise knowledge of the structure of entire dynamic model. As a knowledge-based approach, the fuzzy controller usually depends on linguistics-based reasoning in design. However, even though a system is well defined mathematically, the fuzzy controller is still preferred by control engineers since it is relatively more understandable whereas expert knowledge can be incorporated conveniently. Recently, the fuzzy controller of nonlinear systems was studied by many authors and has also been extensively adopted in adaptive control of robot manipulators (Chen et al., 1996; Labiod et al., 2005; Purwar et al., 2005; Yoo & Ham, 1998). It has been proven that adaptive fuzzy control is a powerful technique and being increasingly applied in the discipline of systems control, especially when the controlled system has uncertainties and highly nonlinearities (Yu et al., 2011).

This chapter is organized as follows. First, the mechanical system is designed in Section 2. Then, modeling and analysis of the cable-driven manipulator are described in Section 3. Section 4 presents the developed systematic approach for the adaptive fuzzy controller

design. Results and discussions are presented in Section 5. Finally, concluding remarks are provided in Section 6.

2. Mechanical design

The CRCM suspends an end-effector (clog) by four cables and restrains all motion degrees of freedom for the object using the cables and gravitational force when the end-effector moves within the workspace. In the design, of each cable in the CRCM, one end is connected to the end-effector, the other end rolls through a pulley fixed on the top of the relative pillar and then is fed into a servo mechanism, with which cable length can be altered. The design of CRCM follows a built-up modular system, as illustrated in Fig.2. The system comprises several components: servo motor, belt pulley drive mechanism, speed reducer, girder, windlass, cable pillar, cable, end-effector, and so on.

Reliability, long-distance transmission, high speed and precision are paramount for the CRCM design. The structure of the CRCM is shown in Fig.3, and the end-effector is driven by four sets of servomechanism. Belts are looped over pulleys. In a two pulley system, the belt can either drive the pulleys in the same direction. As a source of motion, a conveyor belt is one application where the belt is adapted to continually carry a load between two distant points. Typically, gears and elastic drive belts are applied to transmit motion.

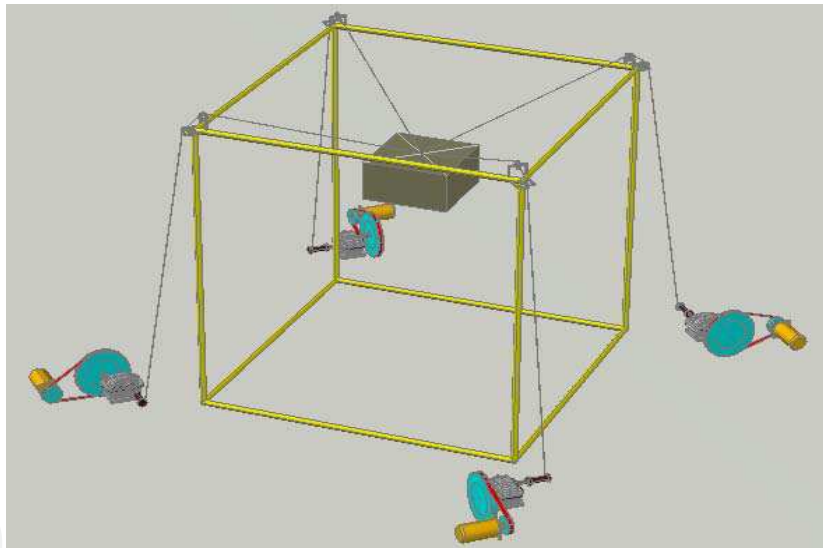

Fig. 2. Model of the CRCM.

3. Modeling and analysis

A simple schematic of the CRCM representing the coordinate systems is shown in Fig. 4. With the bottom of the pillar corresponding to the point B_3 as the origin, a Cartesian coordinate system is established. The end-effector is predigested as a particle whose location coordinates are $A(x, y, z)$, and the distance between each pulley center whose coordinates are $B_i(x_i, y_i, z_i)$ and the end-effector is $l_i (i = 1, 2, 3, 4)$. Four pillars have the same height and are arrayed in a rectangular on the ground, whose deformation in movement is ignored. In order to simplify the calculation, the cable is treated as a kind of massless rigid body, which has no deformation, and can only sustain tension.

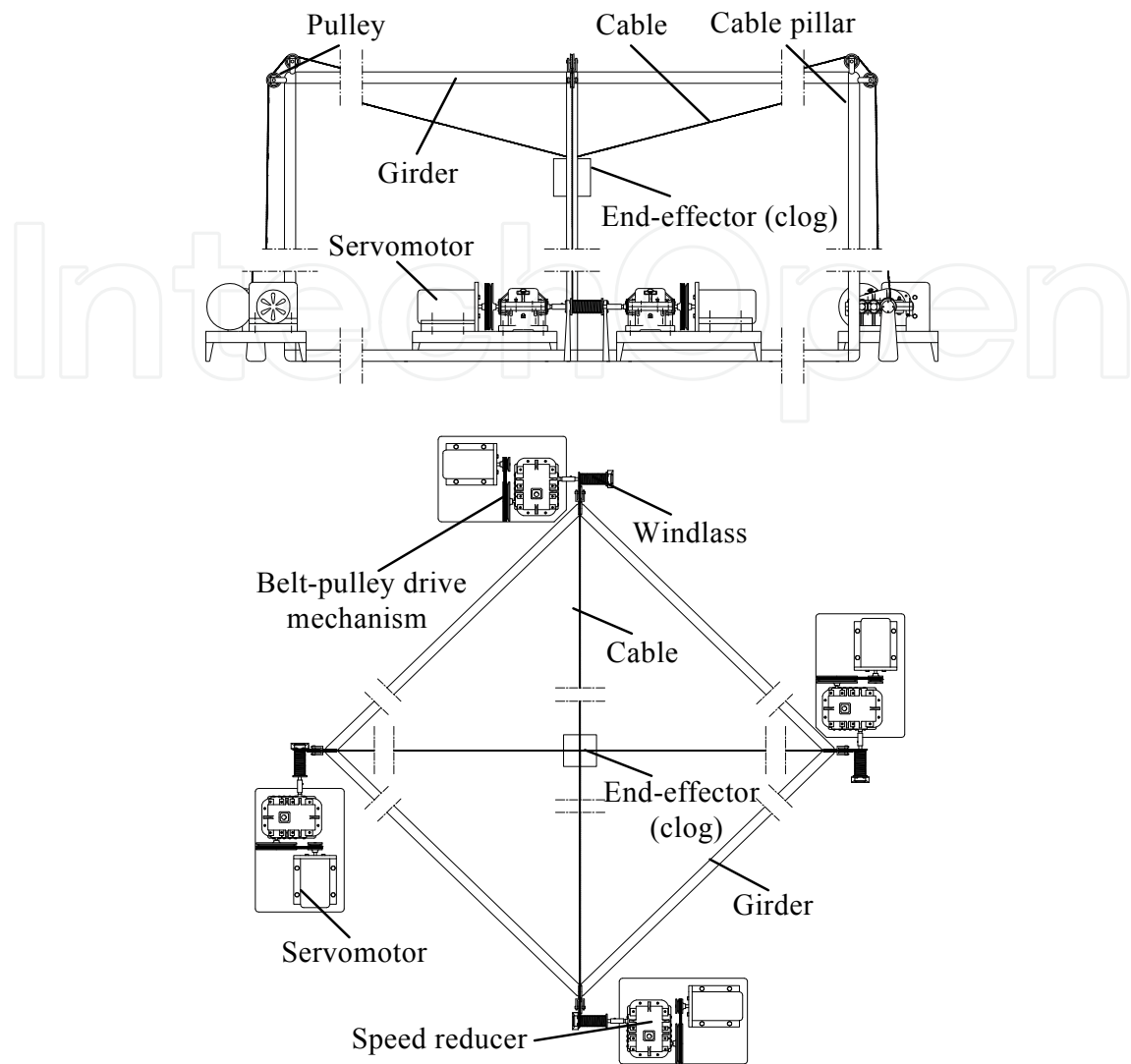

Fig. 3. Mechanical structure of the CRCM

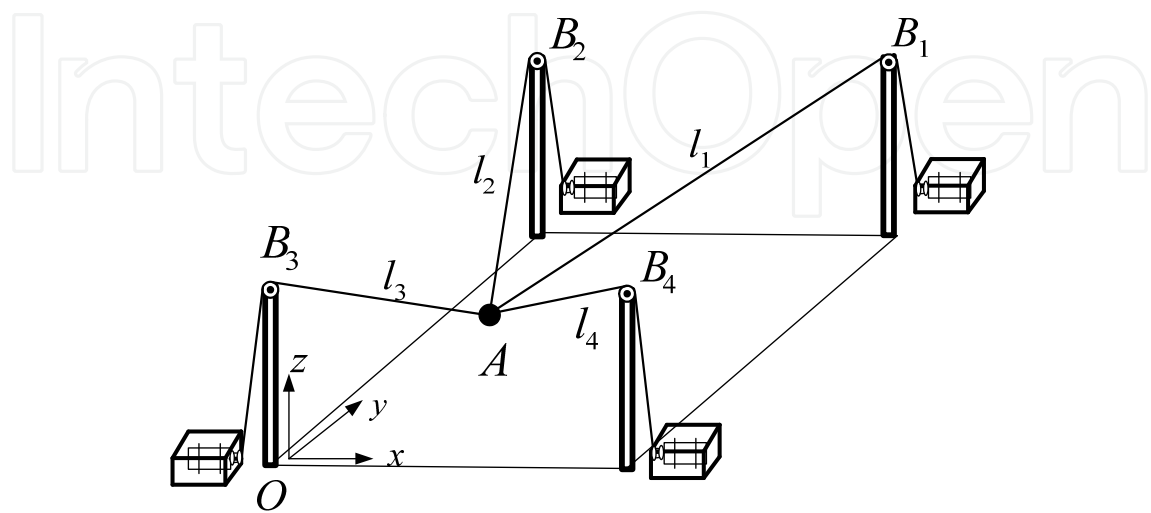

Fig. 4. Structure model of the CRCM

The relationship between the cable length l_i and the end-effector location $A(x, y, z)$, can be easily obtained as follows:

$$\begin{cases} l_1 = \sqrt{(x - x_1)^2 + (y - y_1)^2 + (z - z_1)^2} \\ l_2 = \sqrt{(x - x_2)^2 + (y - y_2)^2 + (z - z_2)^2} \\ l_3 = \sqrt{(x - x_3)^2 + (y - y_3)^2 + (z - z_3)^2} \\ l_4 = \sqrt{(x - x_4)^2 + (y - y_4)^2 + (z - z_4)^2} \end{cases} \quad (1)$$

The forward kinematic equations can be found by solving (1) for (x, y, z) , which results in the following:

$$\begin{cases} x = (l_1^2 - l_2^2 + x_2^2 - x_1^2) / 2(x_2 - x_1) \\ y = (l_2^2 - l_3^2 + y_3^2 - y_2^2) / 2(y_3 - y_2) \\ z = -\sqrt{l_i^2 - (x - x_i)^2 - (y - y_i)^2} + z_i \end{cases} \quad (2)$$

As the pillars are arrayed in a rectangular on the base, according to the geometric relationship, the geometric constraint of the cable length is calculated as

$$l_4^2 + l_2^2 = l_1^2 + l_3^2 \quad (3)$$

The general dynamic equations of motion can be derived from the Lagrangian method. In the model, the end-effector is assumed to act as a point mass and the cable is treated as a kind of massless rigid body. As a result, the kinetic energy, K , and the potential energy, P , of the end-effector can be written in Cartesian coordinates as

$$K = \frac{1}{2}m(\dot{x}^2 + \dot{y}^2 + \dot{z}^2) \quad (4)$$

$$P = mgz \quad (5)$$

where m is mass of end-effector, g is acceleration of gravity.

The cable lengths, l_1 , l_2 , l_3 and l_4 , are directly controlled by rotating the winch to reel the cable in or let it out, therefore, it is desirable to regard the cable lengths as the variables. By substituting the forward kinematic equations (2) into the kinetic energy and potential energy shown in Eqs. (4) and (5), respectively, the Lagrange's Equation can be written in the following form

$$\frac{d}{dt} \left(\frac{\partial K}{\partial \dot{q}_i} \right) - \frac{\partial K}{\partial q_i} + \frac{\partial P}{\partial q_i} = Q_i \quad (6)$$

where and the variables, q_i (for $i = 1, 2, 3, 4$), the generalized forces, Q_i , respectively, can be expressed as

$$q_i = [l_1 \ l_2 \ l_3 \ l_4]^T \quad (7)$$

$$Q_i = [-\tau_1/r_1 - \tau_2/r_2 - \tau_3/r_3 - \tau_4/r_4]^T \quad (8)$$

The windlass torques, τ_1, τ_2, τ_3 and τ_4 , are the control inputs r_1, r_2, r_3 and r_4 , is the radius of the windlass.

Given the equations of motion shown above, using the assumptions along with various substitutions and algebraic manipulations of the CRCM derived, the dynamic equation of the CRCM can be expressed as

$$D(q)\ddot{q} + C(q, \dot{q}) + \tau_d = \tau \quad (9)$$

where $D(q) \in \mathbb{R}^{4 \times 4}$ is the inertia matrix which is symmetric positive definite, $C(q, \dot{q}) \in \mathbb{R}^4$ is a nonlinear Coriolis/centripetal/gravity vector terms, $\tau_d \in \mathbb{R}^4$ represents the disturbance which is bounded, and $\tau \in \mathbb{R}^4$ is the input torque vector with $\tau = [\tau_1 \ \tau_2 \ \tau_3 \ \tau_4]^T$. The 4x4 matrix $D(q)$ and the 4x1 vector $C(q, \dot{q})$ will be referred to as D and C respectively. The details of these expressions will be omitted for the sake of brevity.

The dynamic model is presented in two parts: one is directed to the structural model (CRCM) above and the other is related to the actuator dynamics (servo mechanism). We have already developed mechanics equations of the drive transmission system (Zi et al., 2009), and briefly outline here. The extendable actuator of each subsystem of the CRCM system is comprised of an alternating current (AC) servomotor & drive unit, belt pulley drive mechanism, two-level cycloid-gear speed reducer, and windlass. To simplify matters, here without regard to the belt pulley drive mechanism, the next step servomechanism model is developed. Without going into details, the servomechanism dynamic model is briefly described by the following formulation,

$$\begin{cases} K_U U_C = J_{mi} \frac{d^2 \theta_{mi}}{dt^2} + K_\omega \frac{d\theta_{mi}}{dt} \\ \tau_{bi} = n_i (K_U U_C - K_\omega \frac{d\theta_{mi}}{dt} - J_{ni} \frac{d^2 \theta_{mi}}{dt^2}) \end{cases} \quad (10)$$

where τ_{bi} (for $i = 1, 2, 3, 4$) is the torque of the windlass; n_i is the gear ratio; U_C is control voltage; U_C and K_ω are positive constant, respectively; J_{mi} denotes the moment of inertia of the motor; J_{ni} is the equivalent moment of inertia including motor, speed reducer, flywheel and windlass, and θ_{mi} is the rotor angular position.

The driving force of cable T_i (for $i = 1, 2, 3, 4$) can be expressed as

$$\begin{cases} K_U U_C = J_{mi} \frac{d^2 \theta_{mi}}{dt^2} + K_\omega \frac{d\theta_{mi}}{dt} \\ T_i = \frac{\tau_{bi}}{r_i} = \frac{n_i}{r_i} (K_U U_C - K_\omega \frac{d\theta_{mi}}{dt} - J_{ni} \frac{d^2 \theta_{mi}}{dt^2}) \end{cases} \quad (11)$$

In which, $T = [T_1 \ T_2 \ T_3 \ T_4]^T$; r_i is the radius of the windlass, (for $i = 1, 2, 3, 4$). For more details on the specification of the drive transmission system, refer to (Zi et al., 2009).

The nominal model of CRCM including servomechanism dynamics is described by the following formulation

$$\begin{cases} K_U U_C = J_{mi} \frac{d^2 \theta_{mi}}{dt^2} + K_\omega \frac{d\theta_{mi}}{dt} \\ \tau_{bi} = n_i (K_U U_C - K_\omega \frac{d\theta_{mi}}{dt} - J_{mi} \frac{d^2 \theta_{mi}}{dt^2}) \\ D(q)\ddot{q} + C(q, \dot{q}) + \tau_d = \tau_{bi} \end{cases} \quad (12)$$

It is also well known that there is a dual relation between externally applied wrench on the end-effector and the cable tensions required to keep the system in equilibrium. The above dynamic model is valid only for $T_i > 0$, i.e., the cables are in tension. Clearly, the equation (12) is a non-homogeneous linear quaternary equations. The solution of the equations will be multiple. For the sake of this, the suitable solution is found through MATLAB software based on the pseudo-inverse method.

4. Adaptive fuzzy control

In general, a fuzzy logic system consists of four parts: the knowledge base, the fuzzifier, the fuzzy inference engine, and the defuzzifier. There are many different choices for the design of fuzzy system if the mapping is static. In this study, we consider a MIMO fuzzy logic system (Liu, 2008; Yoo & Ham, 2000). Supposing the fuzzy logic system performs a mapping from fuzzy sets in $U \subseteq R^n$ to fuzzy sets in $V \subseteq R^m$, where $U = U_1 \times \dots \times U_n \subseteq R^n$, $U_i \in R$ (for $i = 1, 2, \dots, n$), $V = V_1 \times \dots \times V_m \subseteq R^m$, $V_j \in R$ (for $j = 1, 2, \dots, m$). For a MIMO system, the fuzzy knowledge base consists of a collection of fuzzy IF-THEN rules in the following form

$$\begin{aligned} R^{(l)} : & \text{IF } x_1 \text{ is } F_1^l \text{ and...and } x_n \text{ is } F_n^l \\ & \text{THEN } y_1 \text{ is } C_1^l \text{ and...and } y_m \text{ is } C_m^l \end{aligned} \quad (13)$$

where $x = [x_1, \dots, x_n]^T \in U$ and $y = [y_1, \dots, y_m]^T \in V$ are the input and output vectors of the fuzzy system, respectively, F_i^l and C_j^l (for $l = 1, 2, \dots, M$) are linguistic variables, and M is the number of fuzzy rules. Based on the fuzzy inference engine working on fuzzy rules, the defuzzifier maps fuzzy sets in U to a crisp point in V .

The output of the fuzzy control system with singleton fuzzifier, product inference engine, center average defuzzifier is in the following form (Yoo & Ham, 2000)

$$y_j = \frac{\sum_{l=1}^M y_j \left(\prod_{i=1}^n \mu_{F_i^l}(x_i) \right)}{\sum_{l=1}^M \left(\prod_{i=1}^n \mu_{F_i^l}(x_i) \right)} \quad (14)$$

where $\bar{y}_j^l \in R$ (for $j=1,2,\dots,m$) is a crisp value at which the membership function μ_{C^l} for output fuzzy set reaches its maximum, and $\mu_{F_i^l}(x_i)$ is the membership function of the linguistic variable x_i , defined as

$$\mu_{F_i^l}(x_i) = \exp\left[-\frac{(x_i - \bar{x}_i^l)^2}{\sigma^2}\right] \quad (15)$$

where \bar{x}_i^l and σ are respectively, the mean and the deviation of the Gaussian membership function. The fuzzy control system inputs are composed of the five linguistic terms: NB (Negative Big), NO (Negative Medium), SS (Zero), PO (Positive Medium), and PB (Positive Big).

As the fixed nonlinear mapping in the hidden layer, $\varepsilon(x)$ is defined as

$$\varepsilon_i(x) = \frac{\prod_{i=1}^n \mu_{F_i^l}(x_i)}{\sum_{l=1}^M \left(\prod_{i=1}^n \mu_{F_i^l}(x_i) \right)} \quad (16)$$

In order to maintain the consistent performance of the fuzzy control system in situations where there is uncertainty variation, the fuzzy control system should be adaptive. Therefore, (14) can be rewritten as

$$y_j = \Theta_j^T \varepsilon(x) \quad (17)$$

where $\varepsilon(x) = [\varepsilon_1(x), \dots, \varepsilon_M(x)]^T \in R^M$ is the fuzzy antecedent function vector, and $\Theta_j = \begin{bmatrix} -1 \\ y_j \\ \dots \\ y_j \end{bmatrix}^T \in R^M$ is the center of the fuzzy subset C_j .

In the following analysis, it will be assumed that the dynamic model of the robot manipulator to be controlled is well known, and all the state variables can be measurable. The control system requirements for the CRCM are similar to those of almost all manipulators. In order to follow the desired continuously differentiable and uniformly bounded trajectory q_d and keep the tracking error $e(t) = q - q_d$ approach zero, a sliding surface, s , is defined in the stable state space (Liu, 2008). The most common sliding surface is chosen as follows

$$s = \dot{e} + \lambda e \quad (18)$$

where λ is a positive definite design parameter matrix.

Now introduce the variable q_r , and define

$$\dot{q}_r(t) = \dot{q}_d(t) - \lambda e(t) \quad (19)$$

Then Eq. (18) can be rewritten as

$$s = \dot{q} - \dot{q}_r \tag{20}$$

Let us consider the Lyapunov function candidate

$$V(t) = \frac{1}{2} \left(s^T D s + \sum_{i=1}^n \tilde{\Theta}_i^T \Gamma_i \tilde{\Theta}_i \right) \tag{21}$$

where $\tilde{\Theta}_i = \Theta_i^* - \Theta_i$, Θ_i (for $i=1, 2, 3, 4$) is the parameter vector, Θ_i^* is the ideal parameter, and Γ_i is a positive definite diagonal matrix.

To prove the negative definition of $\dot{V}(t)$, the time derivative of (21) is given as follows

$$\dot{V}(t) = -s^T (D\dot{q}_r + C + \tau_d - \tau) + \sum_{i=1}^4 \tilde{\Theta}_i^T \Gamma_i \dot{\tilde{\Theta}}_i \tag{22}$$

where τ_d is nonlinear function. Since the disturbance is related to the position and velocity signal, τ_d can be written in the form of $F(q, \dot{q})$. Hence, Eq. (22) can be rewritten as

$$\dot{V}(t) = -s^T (D\dot{q}_r + C + F - \tau) + \sum_{i=1}^4 \tilde{\Theta}_i^T \Gamma_i \dot{\tilde{\Theta}}_i \tag{23}$$

It is considered that the fuzzy logic compensation control is to approach just for the external disturbance, and the fuzzy logic system $F(q, \dot{q} | \tilde{\Theta})$ for the CRCM system is defined as

$$\hat{F}(q, \dot{q} | \tilde{\Theta}) = \Theta_i^T \varepsilon(q, \dot{q}) \tag{24}$$

where $\varepsilon(q, \dot{q})$ is fuzzy basis function (for $i=1,2,3,4$).

From the previous results, the control law is given as follows

$$\tau = D(q)\ddot{q} + C(q, \dot{q})\hat{F}_i(q, \dot{q} | \tilde{\Theta}) - K_D s \tag{25}$$

where $K_D = \text{diag}(K_i)$, $K_i > 0$ (for $i = 1, 2, 3, 4$), and $\hat{F}(q, \dot{q} | \tilde{\Theta})$ can be written as

$$\hat{F}(q, \dot{q} | \tilde{\Theta}) = \begin{bmatrix} \hat{F}_1(q, \dot{q} | \tilde{\Theta}) \\ \hat{F}_2(q, \dot{q} | \tilde{\Theta}) \\ \hat{F}_3(q, \dot{q} | \tilde{\Theta}) \\ \hat{F}_4(q, \dot{q} | \tilde{\Theta}) \end{bmatrix} = \begin{bmatrix} \Theta_1^T \varepsilon(q, \dot{q}) \\ \Theta_2^T \varepsilon(q, \dot{q}) \\ \Theta_3^T \varepsilon(q, \dot{q}) \\ \Theta_4^T \varepsilon(q, \dot{q}) \end{bmatrix} \tag{26}$$

The fuzzy approximation error is defined as

$$w = F(q, \dot{q}) - \hat{F}(q, \dot{q} | \tilde{\Theta}) \quad (27)$$

Substituting Eqs. (25)-(27) into Eq. (23), the following equation can be derived

$$\begin{aligned} \dot{V}(t) &= -s^T (D\ddot{q}_r + C + F - \tau) + \sum_{i=1}^4 \tilde{\Theta}_i^T \Gamma_i \dot{\tilde{\Theta}}_i \\ &= -s^T (\Theta_i^T \varepsilon(q, \dot{q}) + w + K_D s) + \sum_{i=1}^4 \tilde{\Theta}_i^T \Gamma_i \dot{\tilde{\Theta}}_i \\ &= -s^T K_D s - s^T w + \sum_{i=1}^4 (\tilde{\Theta}_i^T \Gamma_i \dot{\tilde{\Theta}}_i - s_i \Theta_i^T \varepsilon(q, \dot{q})) \end{aligned} \quad (28)$$

Then, the adaptive law is defined as

$$\dot{\tilde{\Theta}}_i = -\Gamma_i^{-1} s_i \varepsilon(q, \dot{q}) \quad (29)$$

Since the minimum approximation error, w , can be sufficiently small through designing the fuzzy logic system with enough rules, and satisfying $\sum_{i=1}^4 (\tilde{\Theta}_i^T \Gamma_i \dot{\tilde{\Theta}}_i - s_i \Theta_i^T \varepsilon(q, \dot{q})) = 0$. In addition, $K_D > 0$. Consequently, we get

$$\dot{V}(t) - s^T K_D s - s^T w < 0 \quad (30)$$

Based on Lyapunov stability theory, and the result of Eq. (30), it is shown that the closed-loop system is asymptotically stable, and the scheduled control object can be realized.

5. Results and analysis

In order to justify the dynamic modeling the CRCM, we performed a series of simulations. This section presents two motion cases of the end-effector for dynamic simulation. A simulation for the dynamic model of the CRCM was carried out by Matlab 7.0 software. Some parameters of the CRCM are given as follows: the height of the pillar is 2 m, Pillars $B_1 \sim B_4$ are distributed evenly on the vertices of a square, with the side length of 2 m, and the quality of the end-effector is 5 kg. The acceleration of gravity g is 9.8 m/s^2 .

The spatial circle trajectory can be expressed as

$$\begin{cases} x = 1 + 0.3 \times \cos(0.2\pi t) \\ y = 1.5 + 0.3 \times \sin(0.2\pi t) \\ z = 1 \end{cases} \quad (31)$$

And the spatial helical trajectory is as follows

$$\begin{cases} x = 0.5 + 0.3 \cos(0.1\pi t) \\ y = 0.5 + 0.3 \sin(0.1\pi t) \\ z = 0.2 + 0.05t \end{cases} \quad (32)$$

Fig. 5 displays the workspace of the end-effector of the CRCM. The spatial helical following trajectory and the spatial circle following trajectory of the end-effector are shown in Fig. 6 and Fig. 9, respectively.

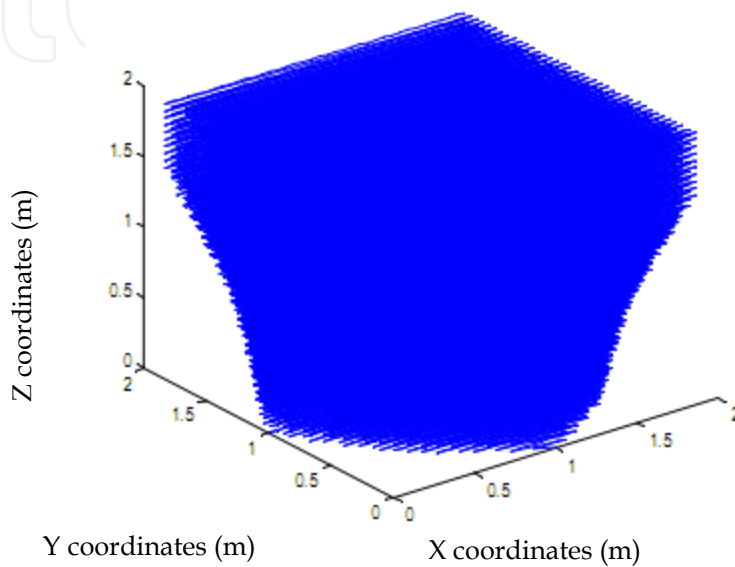

Fig. 5. Workspace of the end-effector.

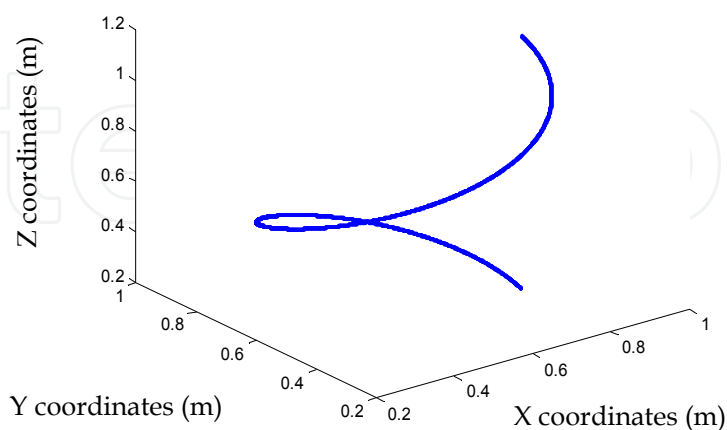

Fig. 6. Following trajectory of the end-effector.

Fig. 7, Fig. 8, Fig. 10 and Fig. 11 show the changes in length and the tension of the cables in the two different trajectories tracking, respectively. As can be seen in Figs. 6-11, the above

formulation tracks the planned trajectory relatively well. From the above simulation results, it can be concluded that the dynamic modeling is justified.

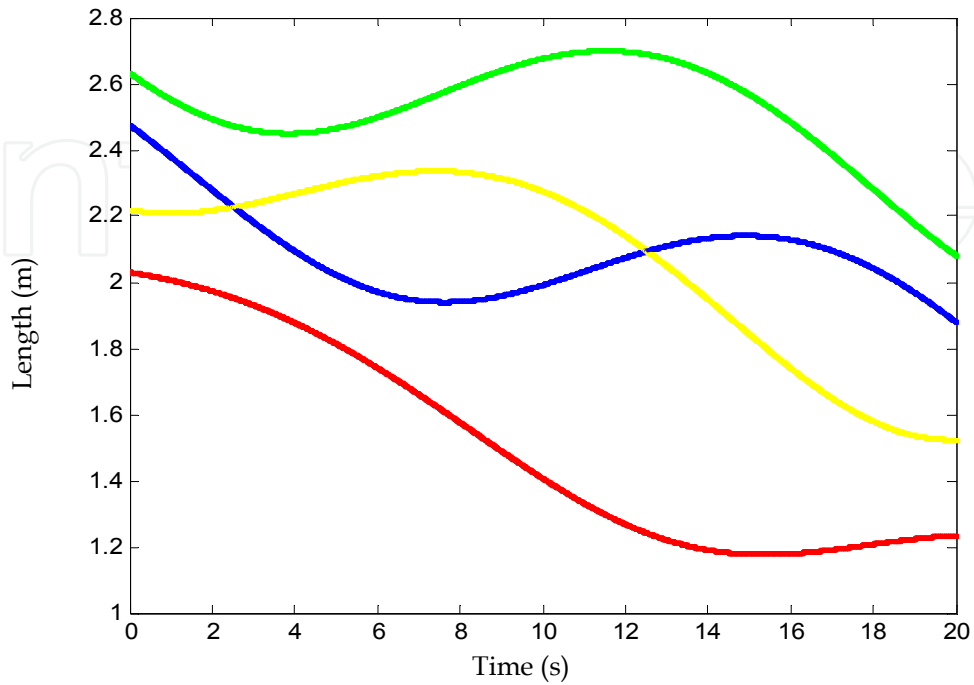

Fig. 7. Changes in length of cable for the helical motion.

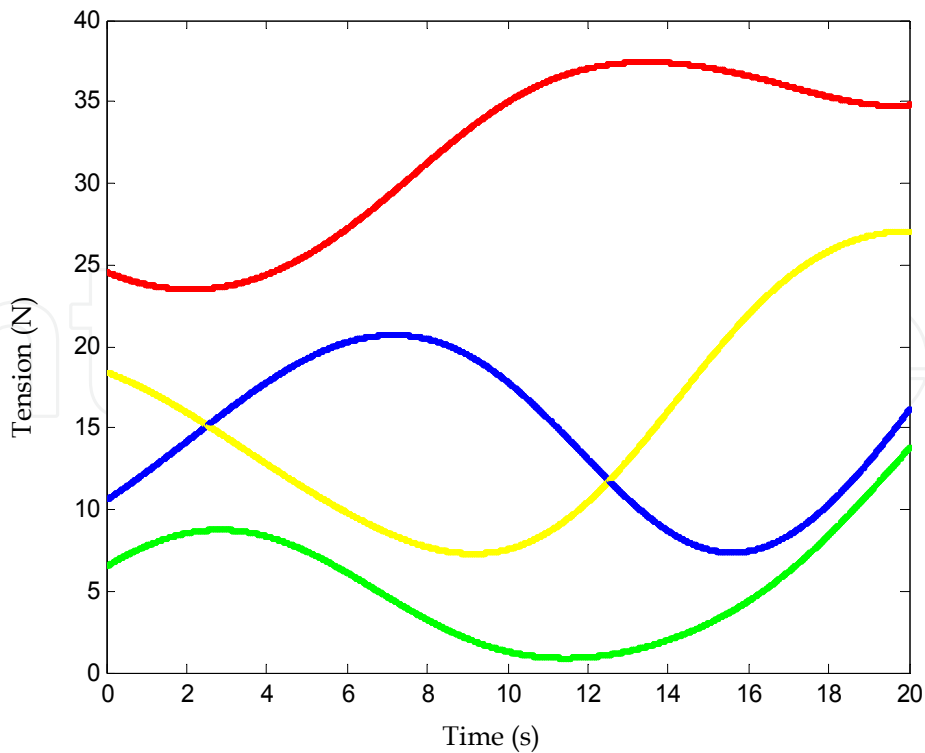

Fig. 8. Changes in tension of cable for the helical motion.

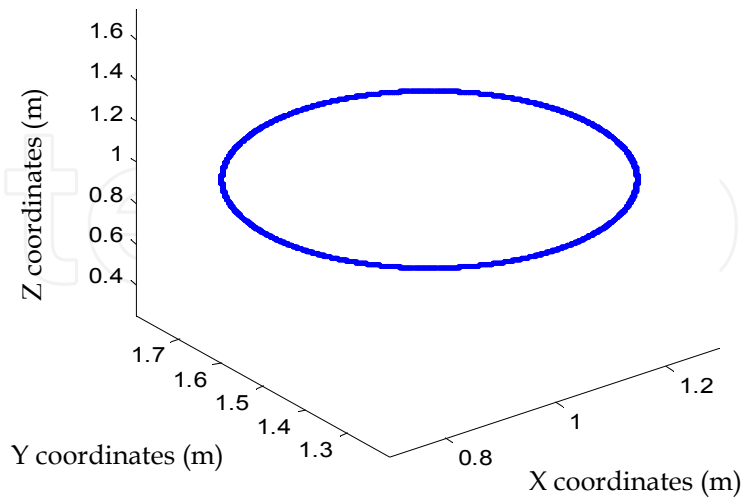

Fig. 9. Following trajectory of the end-effector.

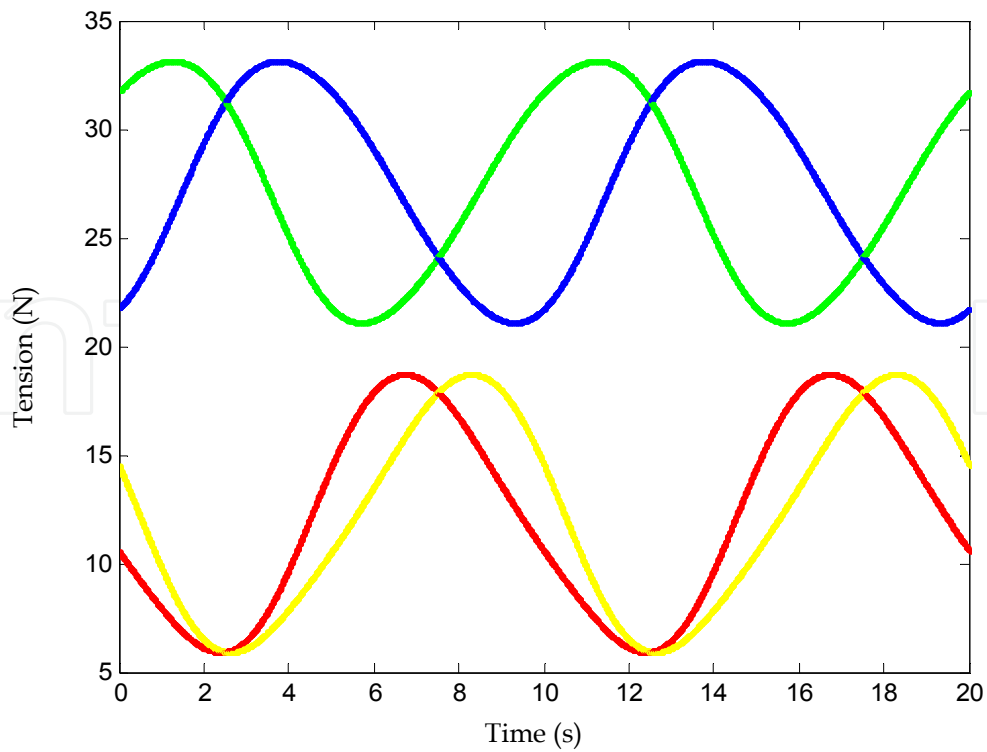

Fig. 10. Changes in tension of cable for the circle motion

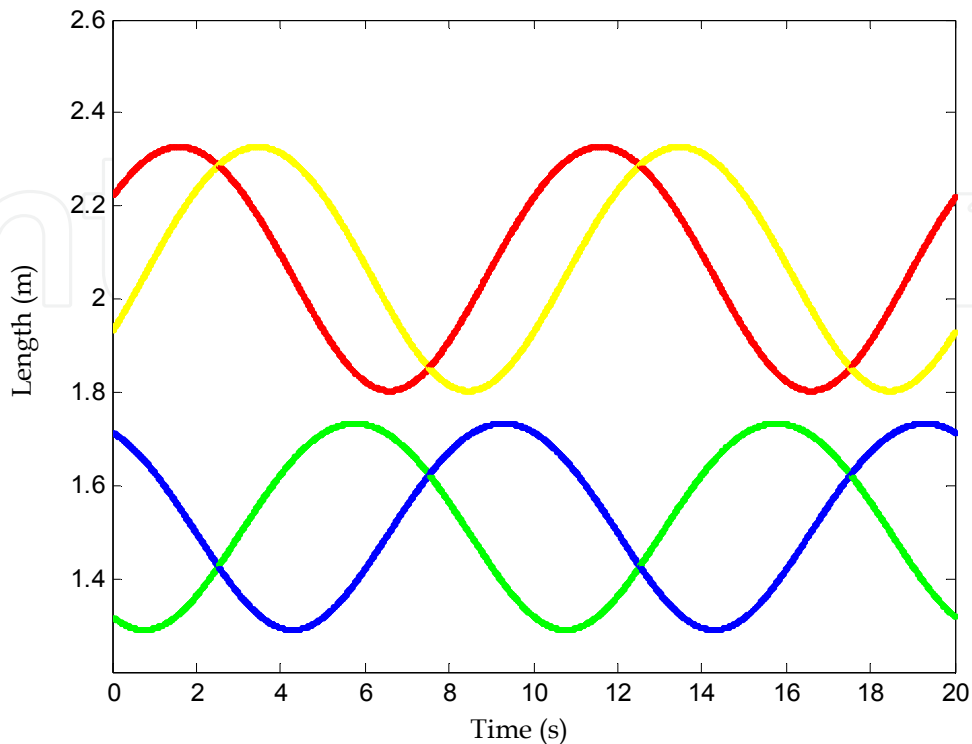

Fig. 11. Changes in length of cable for the circle motion.

In order to assess the performance of the adaptive fuzzy control system of the CRCM, simulations in spatial circle trajectory motion have been performed. The initial length configuration of the cables of the CRCM is given as $q(0) = [1.32 \ 1.71 \ 2.22 \ 1.93]^T$, and the other consequent parameters are initialized to zero. The nonlinearity $F(q, \dot{q})$ is estimated by using five Gaussian fuzzy sets for q and \dot{q} , which is constructed, as shown in Fig 12. The disturbance vector is $\tau_d = [15 \sin(20t) \ 10 \sin(20t) \ 10 \sin(20t) \ 15 \sin(20t)]^T$. The design parameters of the controller are determined as $\lambda = 10$, $\Gamma = 0.001$, $K_D = 250I$, and I is a 4×4 matrix. The resulting fuzzy set must be converted to a signal that can be sent to the process as a control input. Based on S-Function, the Simulink model of the CRCM is shown in Fig 13.

Figs. 14 and 15 display the trajectory tracking of the end-effector of the CRCM, respectively. From Fig. 14, the above formulation tracks the planned trajectory relatively well. Figs. 16 and 17 illustrate the position trajectory and the position errors of the end-effector in x , y , z directions, respectively. The changes in length and the length trajectory tracking errors of the cables l_1, l_2, l_3, l_4 are shown in Fig. 18 and Fig. 19, respectively. In Figs. 16 and 18, the desired trajectory is indicated in a red solid line, and the actual output is in a blue dash line, and from Fig. 16 and Fig. 18, it can be seen that the actual and desired trajectories almost overlap each other.

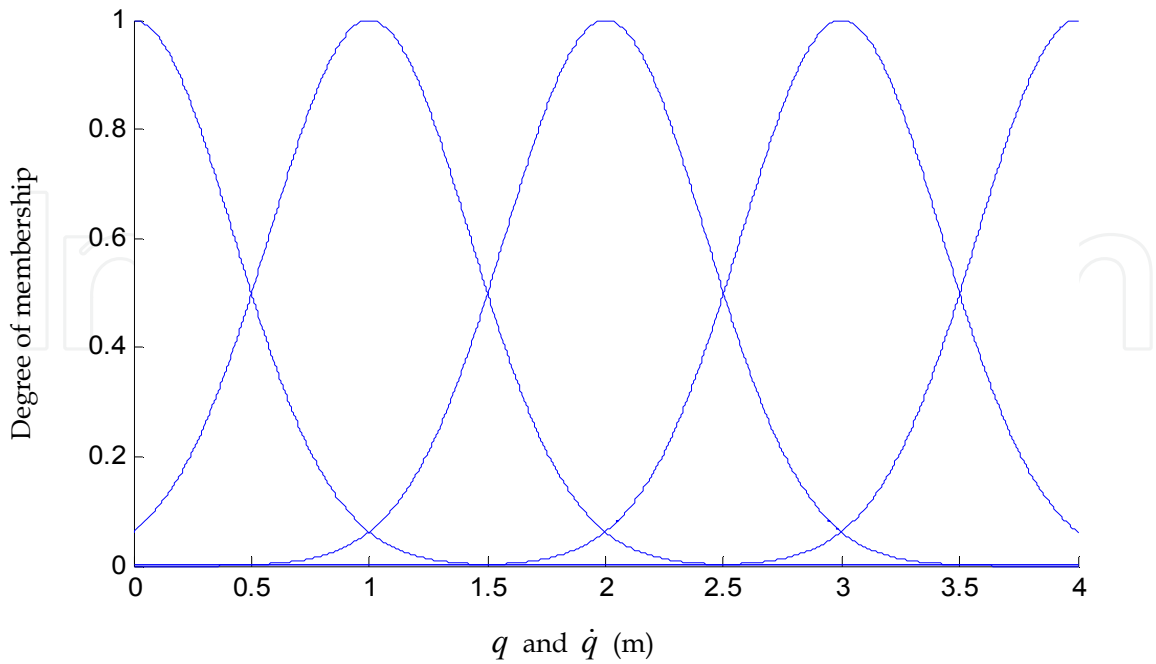

Fig. 12. Membership function of input variables.

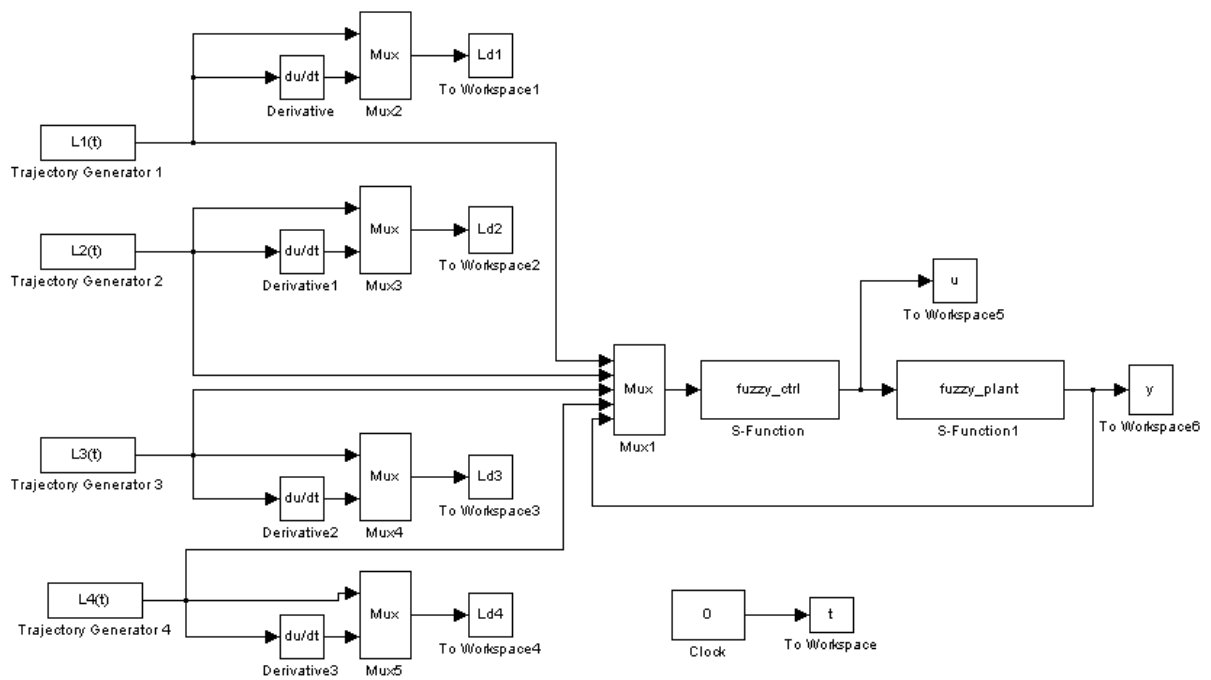

Fig. 13. Simulink model of the CRCM.

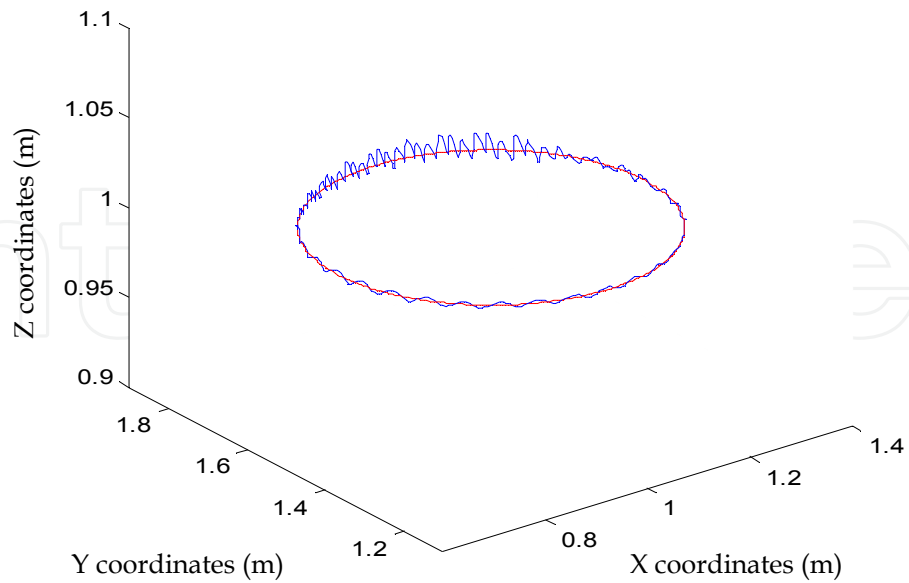

Fig. 14. Following trajectory of the end-effector.

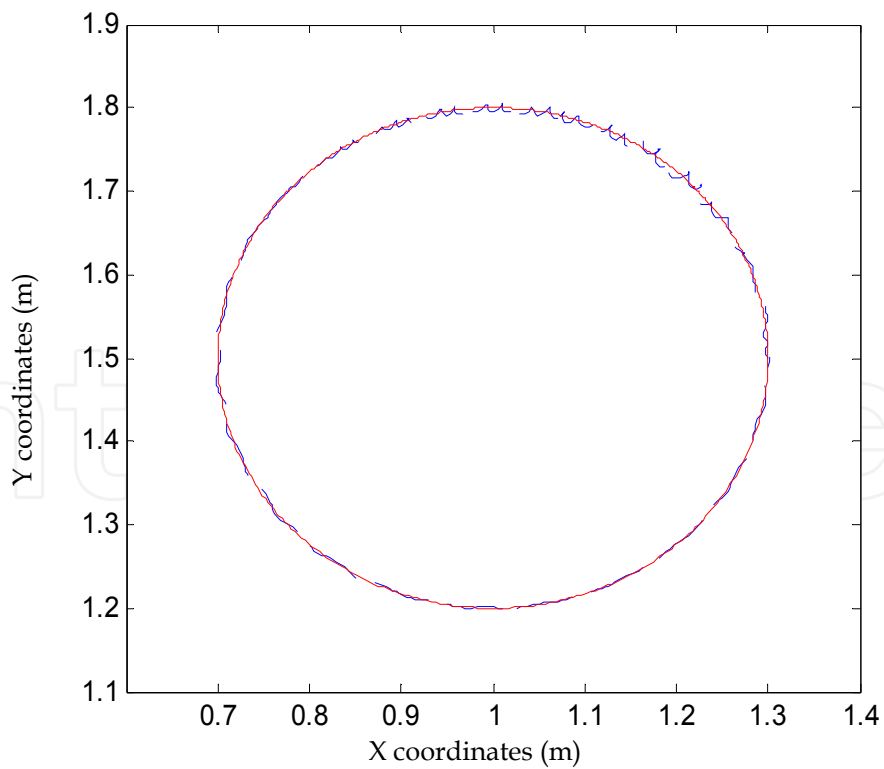

Fig. 15. Following trajectory of the end-effector

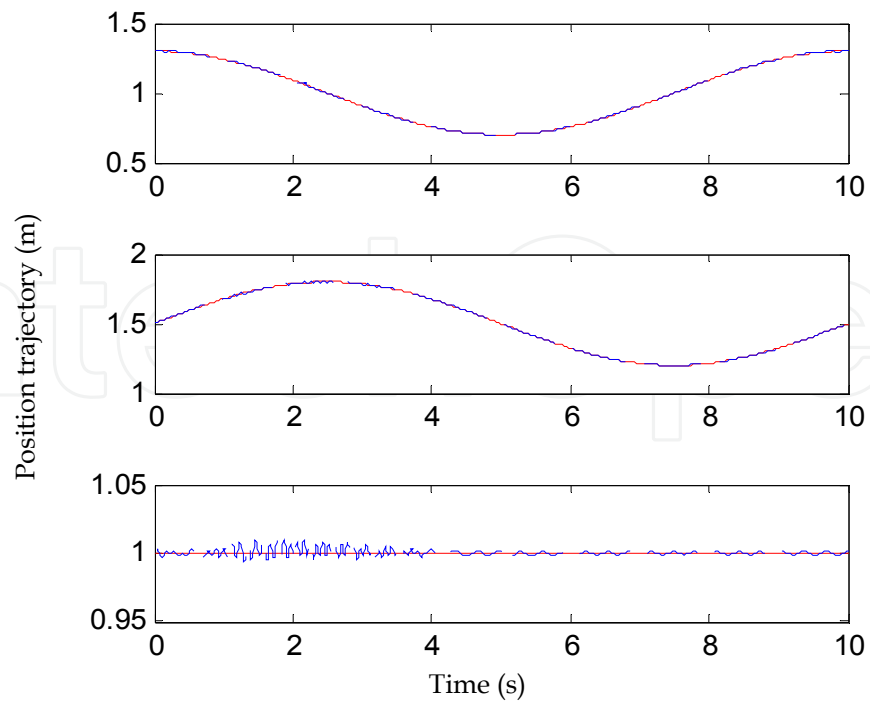

Fig. 16. Position trajectory of the end-effector in x, y and z directions

Fig. 20 displays the disturbance τ_d and its compensator, and the control input torques of the winch are shown in Fig. 21. From the simulation results, it may be concluded that the adaptive fuzzy control strategy can achieve a favourable control performance and has high robustness.

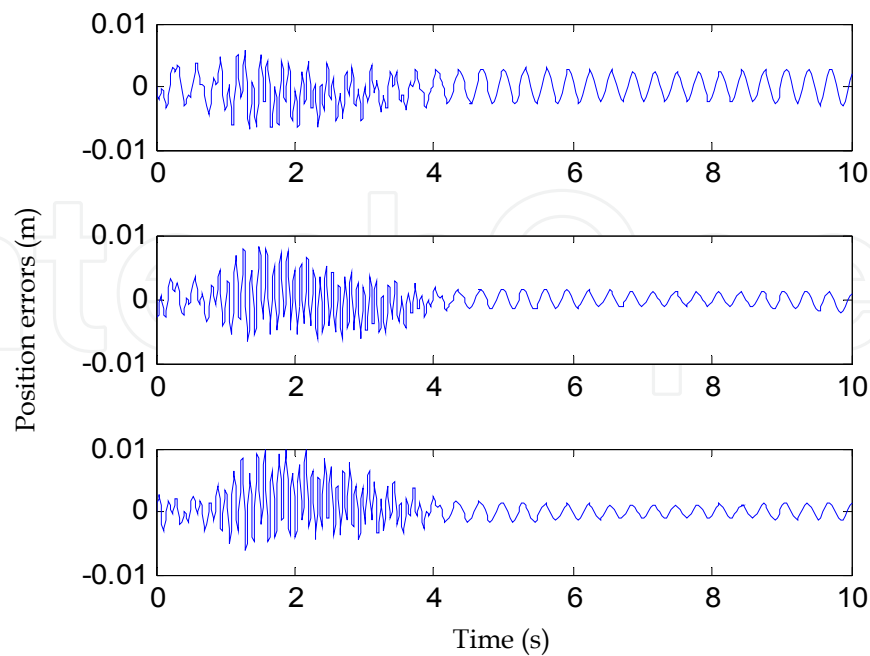

Fig. 17. Position errors of the end-effector in x, y and z directions.

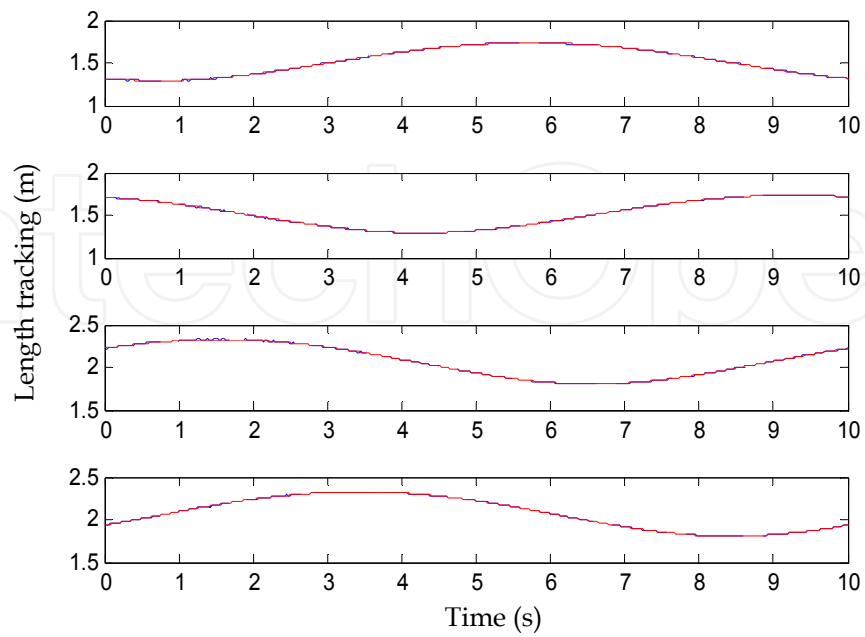

Fig. 18. Length tracking of the cables l_1, l_2, l_3, l_4

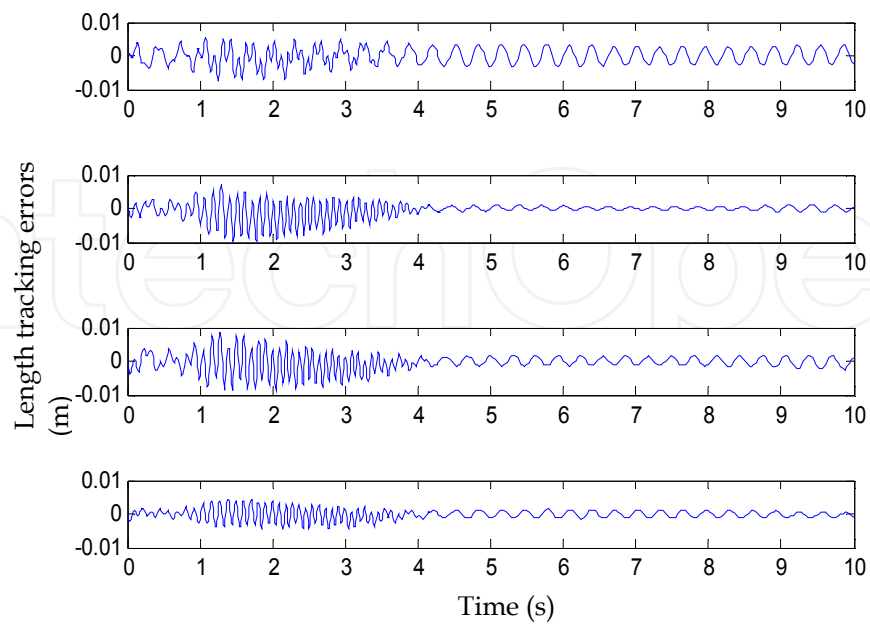

Fig. 19. Length tracking errors of the cables l_1, l_2, l_3, l_4

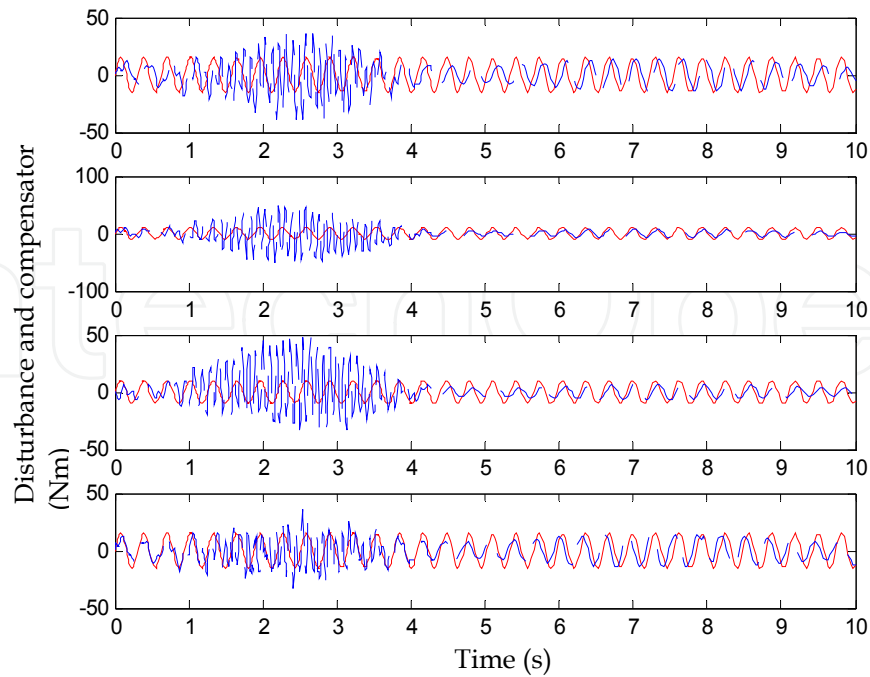

Fig. 20. The disturbance τ_d and its compensator.

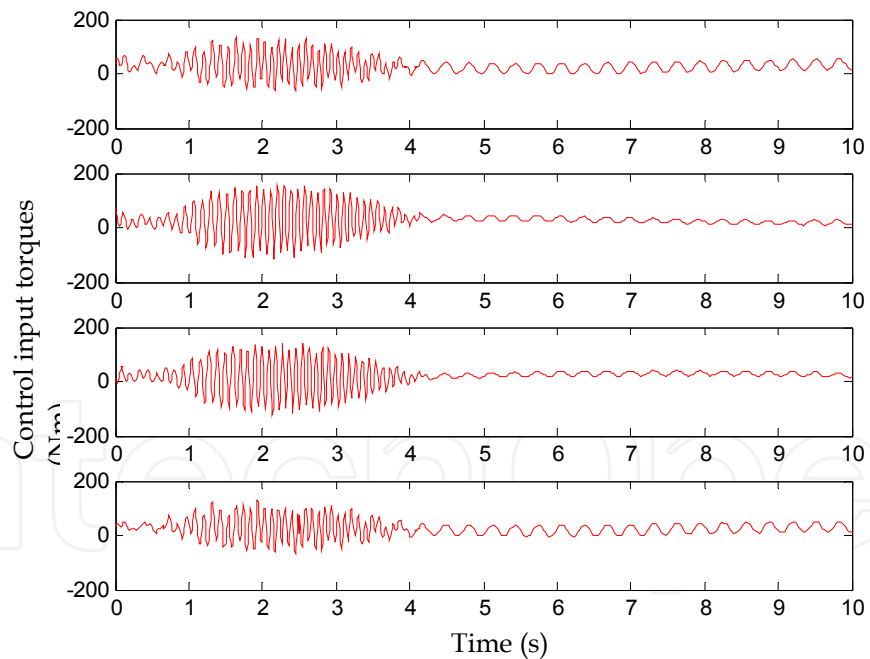

Fig. 21. The control input torques of the windlass $\tau_1, \tau_2, \tau_3, \tau_4$

6. Conclusion

Cable parallel manipulators are a class of robotic mechanisms whose simplicity of design, light weight and ability to support large loads make them useful in many industrial and military settings. This chapter presented in detail a 3-DOF, 4-cable CRCM for its adaptive

fuzzy control system design and analysis. The mechanical system is designed, and the dynamic formulation of the electromechanical coupling system for the CRCM is studied on the basis of the Lagrange's Equation and equivalent circuit of the servo mechanism, and the inverse kinematic problem and inverse dynamics problem of the CRCM system is resolved on condition that operation path of the end-effector has been planned. Computational examples are provided to demonstrate the validity of the model developed. In addition, according to the established dynamic equation of the CRCM, an adaptive fuzzy control system is designed to track a given trajectory. Based on Lyapunov stability analysis, we have proved that the end-effector motion tracking errors converge asymptotically to zero. Simulation results are presented to show the satisfactory performance of the adaptive fuzzy control system. This will make the CRCM used in the more precision production field such as part assembly. Future work will be devoted to the experimental validation of the control system.

7. Acknowledgements

This work was supported by the National Natural Science Foundation of China (50905179) and the Visiting Scholar Foundation of Key Lab in University (GZKF-201112).

8. References

- Anupoj, C. M.; Su, C. Y. & Oya, M. (2005). Adaptive Motion Tracking Control of Uncertain Nonholonomic Mechanical Systems Including Actuator Dynamics. *IEEE Proceedings Control Theory and Applications*, Vol.152, No.5, (September 2005), pp. 575-580, ISSN 1350-2379
- Borgstrom, P. H.; Borgstrom, N. P.; Stealey, M. J. & Jordan, B. (2009). Design and Implementation of NIMS3D, a 3-D Cabled Robot for Actuated Sensing Applications. *IEEE Transaction on Robotics*, Vol.25, No.2, (April 2009), pp. 325-339, ISSN 1552-3098
- Bosscher, P. & Ebert-Uphoff, I. (2006). Disturbance robustness measures for underconstrained cable-driven robots. *Proceedings of the IEEE International Conference on Robotics and Automation*, pp. 4205-4212, ISBN 0-7803-9505-0, Orlando, Florida, USA, May 15-19, 2006.
- Behzadipour, S. & Khajepour, A. (2005). A New Cable-Based Parallel Robot with Three Degrees of Freedom. *Multibody System Dynamics*, Vol. 13, No.4, (May 2005), pp. 371-383, ISSN 1384-5640
- Chen, B. S.; Lee, C. H. & Chang, Y. C. (1996). H^∞ Tracking Design of Uncertain Nonlinear SISO Systems: Adaptive Fuzzy Approach. *IEEE Transaction on Fuzzy Systems*, Vol. 4, No.1, (February 1996), pp. 32-43, ISSN 1063-6706
- Chien, C. J. (2008). A Combined Adaptive Law for Fuzzy Iterative Learning Control of Nonlinear Systems With Varying Control Tasks. *IEEE Transaction on Fuzzy Systems*, Vol. 16, No. 1, (February 2008), pp. 40-51, ISSN 1063-6706
- Craig, J. J. (2005). *Introduction to robotics, mechanics and control*, China Machine Press, ISBN 7-111-11577-5, Beijing, China
- Chang, Y. C. (2000). Robust Tracking Control for Nonlinear MIMO Systems via Fuzzy Approaches. *Automatica*, vol. 36, No. 10, (February 2000), pp. 1535-1545, ISSN 0005-1098

- Feng, G. (2006). A Survey on Analysis and Design of Model-based Fuzzy Control Systems, *IEEE Transaction on Fuzzy Systems*, Vol. 14, No. 5, (October 2006), pp. 676–697, ISSN 1063-6706
- Ghasemi, A.; Eghtesad, M. & Farid, M. (2008). Workspace analysis of planar and spatial redundant cable robots. *American Control Conference*, pp. 2389-2394, ISBN 978-1-4244-2078-0, Seattle, Washington, USA, June 11-13, 2008.
- Labioud, S.; Boucherit, M. S. & Guerra, T. M. (2005). Adaptive Fuzzy Control of A Class of MIMO Nonlinear Systems. *Fuzzy Sets and Systems*, Vol. 151, No. 1, (April 2005), pp. 59-77, ISSN 0165-0114
- Liu, J. K. (2008). *Design of Robot Control System and Matlab Simulation*. Tsinghua University Press, ISBN 7-302-09658-9, Beijing, China.
- Motoji, Y.; Noritaka Y. & Akira M. (2004). Trajectory Control of Incompletely Restrained Parallel Wire-Suspended Mechanism Based on Inverse Dynamics. *IEEE Transaction on Robotics*, Vol.20, No.5, (October 2004), pp. 840-850, ISSN 1052-3098
- Oh, S. R. & Agrawal, S. K. (2005). Cable Suspended Planar Robots with Redundant Cables: Controllers with Positive Tensions. *IEEE Transaction on Robotics*, Vol.21, No.3, (June 2005), pp. 457-465, ISSN 1052-3098
- Purwar, S.; Kar, I. N. & Jha, A. N. (2005). Adaptive Control of Robot Manipulators Using Fuzzy Logic Systems Under Actuator Constraints. *Fuzzy Sets and Systems*, (June 2005), Vol. 152, No. 3, pp. 651-664, ISSN 0165-0114
- Pham, C. B.; Yeo, S. H.; Yang, G.; Kurbanhusen, M. S. & Chen, I. M. (2006). Force-Closure Workspace Analysis of Cable-Driven Parallel Mechanisms. *Mechanism and Machine Theory*, Vol.41, No.1, (January 2006), pp. 53–69, ISSN 0094-114X
- Reznik, L.; Ghanayem, O. & Bourmistrov, A. (2000). PID Plus Fuzzy Controller Structures as Design Base for Industrial Applications. *Engineering Application of Artificial Intelligence*, (August 2000), vol.13, No. 4, pp. 419-430, ISSN 0952-1976
- Soyguder, S. & Alli, H. (2010). Fuzzy Adaptive Control for the Actuators Position Control and Modeling of An Expert System. *Expert Systems with Applications*, Vol. 37, No. 3, (March 2010), pp. 2072 – 2080, ISSN 0957-4174
- Su, C. Y. & Stepanenko, Y. (1994). Adaptive Control of a Class of Nonlinear Systems with Fuzzy Logic. *IEEE Transaction on Fuzzy Systems*, Vol. 2, No. 4, (November 1994), pp. 285-294, ISSN 1063-6706
- Visioli, A. (2001). Tuning of PID Controllers With Fuzzy Logic. *IEEE Proceedings Control Theory and Application*, Vol.148, No.1, (January 2001), pp. 1-8, ISSN 1350-2379
- Yu, J. P.; Chen, B.; Yu, H. S. & Gao, J. W. (2011). Adaptive Fuzzy Tracking Control for The Chaotic Permanent Magnet Synchronous Motor Drive System via Backstepping. *Nonlinear Analysis: Real World Applications*, Vol. 12, No. 1, (February 2011) pp. 671–681, ISSN 1468-1218
- Yoo, B. K. & Ham, W. C. (2000). Adaptive Control of Robot Manipulator Using Fuzzy Compensator. *IEEE Transaction on Fuzzy Systems*, (April 2000), Vol. 8, No. 2, pp. 186-199, ISSN 1063-6706
- Yoo, B. K. & Ham, W. C. (1998). Adaptive Fuzzy Sliding Mode Control of Nonlinear System. *IEEE Transaction on Fuzzy Systems*, Vol. 6, No.2, (May 1998), pp. 315-321, ISSN 1063-6706

- Yousef, H.; Hamdy, M.; El-Madbouly, E. & Eteim, D. (2009). Adaptive Fuzzy Decentralized Control for Interconnected MIMO Nonlinear Subsystems. *Automatica*, Vol. 45, No. 2, (February 2009), pp. 456-462, ISSN 0005-1098
- Zi, B.; Duan, B.Y.; Du, J. L. & Bao H. (2008). Dynamic Analysis and Active Control of A Cable-Suspended Parallel Robot. *Mechatronics*, Vol.18, No.1, (February 2008), pp. 1-12, ISSN 0957-4158
- Zi, B.; Zhu, Z. C. & Wei, M. S. (2009). Dynamic Modeling and Control on AC Servomechanism. *China Mechanical Engineering*, Vol.20, No.8, (August 2009), pp.920-927, ISSN 1004-132X
- Zadeh, L. A. (1965). Fuzzy Sets. *Information and Control*, Vol.148, No.1, (January 1965), pp. 338-353, ISSN 1349-4198

IntechOpen

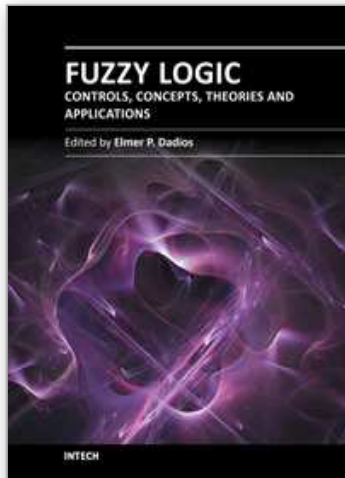

Fuzzy Logic - Controls, Concepts, Theories and Applications

Edited by Prof. Elmer Dadios

ISBN 978-953-51-0396-7

Hard cover, 428 pages

Publisher InTech

Published online 28, March, 2012

Published in print edition March, 2012

This book introduces new concepts and theories of Fuzzy Logic Control for the application and development of robotics and intelligent machines. The book consists of nineteen chapters categorized into 1) Robotics and Electrical Machines 2) Intelligent Control Systems with various applications, and 3) New Fuzzy Logic Concepts and Theories. The intended readers of this book are engineers, researchers, and graduate students interested in fuzzy logic control systems.

How to reference

In order to correctly reference this scholarly work, feel free to copy and paste the following:

Bin Zi (2012). Fuzzy Control System Design and Analysis for Completely Restrained Cable-Driven Manipulators, Fuzzy Logic - Controls, Concepts, Theories and Applications, Prof. Elmer Dadios (Ed.), ISBN: 978-953-51-0396-7, InTech, Available from: <http://www.intechopen.com/books/fuzzy-logic-controls-concepts-theories-and-applications/fuzzy-control-system-design-and-analysis-for-completely-restrained-cable-driven-manipulators>

INTECH
open science | open minds

InTech Europe

University Campus STeP Ri
Slavka Krautzeka 83/A
51000 Rijeka, Croatia
Phone: +385 (51) 770 447
Fax: +385 (51) 686 166
www.intechopen.com

InTech China

Unit 405, Office Block, Hotel Equatorial Shanghai
No.65, Yan An Road (West), Shanghai, 200040, China
中国上海市延安西路65号上海国际贵都大饭店办公楼405单元
Phone: +86-21-62489820
Fax: +86-21-62489821

© 2012 The Author(s). Licensee IntechOpen. This is an open access article distributed under the terms of the [Creative Commons Attribution 3.0 License](#), which permits unrestricted use, distribution, and reproduction in any medium, provided the original work is properly cited.

IntechOpen

IntechOpen