

We are IntechOpen, the world's leading publisher of Open Access books Built by scientists, for scientists

4,800

Open access books available

122,000

International authors and editors

135M

Downloads

Our authors are among the

154

Countries delivered to

TOP 1%

most cited scientists

12.2%

Contributors from top 500 universities



WEB OF SCIENCE™

Selection of our books indexed in the Book Citation Index
in Web of Science™ Core Collection (BKCI)

Interested in publishing with us?
Contact book.department@intechopen.com

Numbers displayed above are based on latest data collected.

For more information visit www.intechopen.com



Capabilities of Piezoelectric Immunosensors for Detecting Infections and for Early Clinical Diagnostics

Tatyana Ermolaeva and Elena Kalmykova
*Lipetsk State Technical University, Department of Chemistry,
Laboratory of Chemical and Biochemical Sensors,
Russia*

1. Introduction

Methods of early laboratory diagnostics which allow the prevention of diseases and their effective treatment, as well as establishing their causes, make a considerable contribution to the prevention and treatment of human diseases. A precise diagnosis is directly connected with the speed and sensitivity of the applied method of clinical diagnostics. Diagnostic tests are also important in pharmacology and pharmacokinetics for estimating the effectiveness of medications used in medical treatment and for controlling their digestion. First of all it concerns the diagnostics of such widespread diseases of civilisation as cardiovascular and coronary heart diseases, diabetes, oncological and infectious diseases. Besides diagnosing diseases, laboratory methods must determine genetic predisposition to serious pathologies, as well as determine – with high reliability – the quantitative indicator of pathologies when they are still in a clinical asymptomatic state.

The speed of measurements with the use of biosensors has been the reason for close attention on the part of experts in clinical laboratory diagnostics. The past decade has seen active development of piezoelectric gravimetric immunosensors that provide for the intensification of work in performing a considerable number of tests and the reduction of the time necessary for medical treatment.

A piezoelectric immunosensor is an analytical device, the sensitive element of which is a piezoelectric resonator with electrodes coated by receptor molecules. An obvious advantage of a piezoelectric immunosensor is the possibility to carry out the direct registration of biochemical interaction without the introduction of additional labels (fluorescent, enzyme, radioactive, luminescent, etc.), which makes it different from other similar devices. Sensors are characterised by their fast response, ease of operation, portability, and possibility to be included in automatic systems of information collecting and processing. A unique feature of piezoelectric immunosensors is the combination of high sensitivity, which is provided by the use of a high-frequency piezoelectric transducer as a physical transducer, and selectivity which is determined by the nature of employed receptor molecules. An electrode's coating is formed on the basis of natural bio-recognizing substances characterized by high selectivity of interaction. In order to increase the selectivity and to widen the range of tested

substances, which is especially important in the field of medicine and pharmacology, piezoelectric immunosensors' electrode coatings are formed from natural bio-recognizing compounds which are characterized by high selectivity of interaction.

Currently antibodies – protective proteins formed in the organisms of higher animals in response to the introduction of foreign agents – antigens (nucleic acids DNA and RNA, carbohydrates, etc.) – are most frequently used as key reagents. Both in the living organism and outside it antibodies are capable of forming immune complexes with a complementary antigen (or hapten), despite the presence of a great number of other components in the sample.

A number of reviews (Vaughan et al. 2007, Ermolaeva et al. 2008, Skladal 2003) are devoted to considering the theoretical aspects of piezoelectric immunosensors functioning and the peculiarities of their practical application in determining various analytes.

Gravimetric piezoelectric sensors, named a piezoquartz microbalance (quartz crystal microbalance, QCM), are high-frequency transducers (with the basic frequency of 5-15 MHz) made from an AT-cut quartz crystal. The analytical signal of such a sensor is most commonly the reduction of the oscillation frequency of the resonator with the increase of the receptor layer's mass as a result of its interaction with determined substances. Frequency variation of the oscillating crystal depending on change of the mass fixed on a quartz surface is described by the Sauerbrey equation (Sauerbrey 1959) for rigid, uniform and thin adsorptive layers:

$$\Delta m = C \cdot \Delta f,$$

where m – mass, C – proportionality coefficient, f – crystal oscillation frequency.

There can be a deviation from the Sauerbrey equation and errors in mass measurement for soft or viscous-elastic films which are not fully contacting the oscillatory crystal, therefore it is necessary to standardize (calibrate) a QCM sensor before testing various liquid samples.

The analysis of liquids with the use of piezoelectric sensors can be carried out both in static and flowing modes. In the first case (the procedure being known as «dip and dry») the increase of the receptor layer's mass is measured before and after the contact of the sensor with the analyzed liquid sample and the following air drying up to the constant mass. The use of the sensor as the detector of the flow-injection analysis makes it possible to raise the speed of determination, and also provides the opportunity to observe immunochemical reactions in real time.

The creation of gravimetric biosensors of various designs (test-means, detectors for flow-injection analysis) on the basis of highly specific interactions (antibody-antigen, receptor-ligand, etc.) can expand their range of applications in medicine with the aim of identifying not only toxic micro-organisms, but specific substances that act as a sort of precursors of dangerous diseases.

2. The features of registration of biochemical interactions with the help of piezoelectric immunosensors

The most developed types of immunoassay with the use of piezoelectric transducers are the following: direct, indirect (competitive) and displacing (Ermolaeva et al. 2006, Su et al. 2003).

The sandwich assay and some other ways of amplifying the analytical signal are recommended for increasing the sensitivity of determinations.

Direct detection is used to determine somatic cells, micro-organisms and macromolecules (proteins, antibodies, nucleic acids, glycoproteins, glycolipids, etc.). It is implemented in one step when analyte contacts the sensor's receptor layer. The decrease of resonant frequency due to the formation of the complex on the surface of the electrode is directly proportional to the concentration of the determined component (Fig. 1).

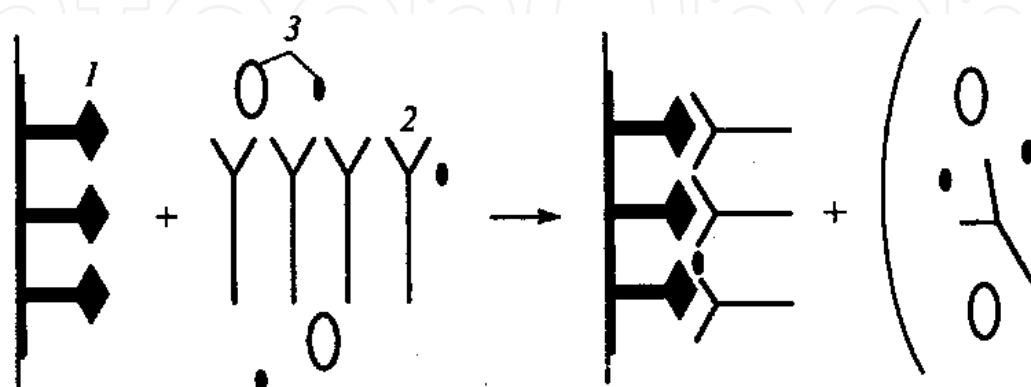

Fig. 1. The scheme of the direct assay of the antibody using piezoelectric immunosensors: 1 - antigen (hapten); 2 - specific antibody; 3 - non-specific components of the mixture

The sensor's electrodes are modified by antigens or antibodies (mono- or polyclonal). Usually the sensor is previously treated with a solution of a non-ionic surfactant or an inactive protein (BSA, gelatine, etc.) in order to increase the selectivity of determination. Such proteins do not cross-interact with the components of the sample but connect with non-specific sites of the sensor's receptor layer. For example, the sensor's receptor layer based on DNA interacts weakly with BSA molecules, causing only a slight frequency signal (not more than 5 Hz), while the serum of patients with symptoms of an autoimmune disease, containing antibodies to DNA, gives an analytical signal on the level of hundreds of Hz (Kalmykova et al. 2002). In order to determine small molecules the indirect/competitive analysis, the sandwiched assay and other types of analysis are used.

The competitive analysis of haptens with the use of piezoelectric sensors (U. S. Patent 4,242,096 1980) was first performed in 1980. While in a routine immunochemical analysis, free and labelled analytes presented in the sample compete for binding with antibodies, in the case of piezoelectric immunosensors the competition takes place between free analyte (hapten) and hapten-protein conjugate immobilized onto the bioreceptor layer. The value of the obtained analytical signal of the sensor is inversely proportional to the concentration of hapten in the sample. The essence of this method is illustrated in Fig. 2.

Such a method has been successfully used for determining different low-molecular-mass haptens: vitamins, drugs, hormones, metabolites, etc. The detection limit of the competitive analysis is lower compared with that of the direct one (Prusak-Sochaczewski et al. 1990), but the range of determined concentrations is narrower by a factor of 10 to 100. In order to apply the competitive analysis, the receptor layer can be formed on the basis of both hapten-protein conjugates and antibodies. In the latter case a fixed quantity of hapten-protein conjugate is added to each sample. This type is known as the **alternative competitive assay** (Fig. 3).

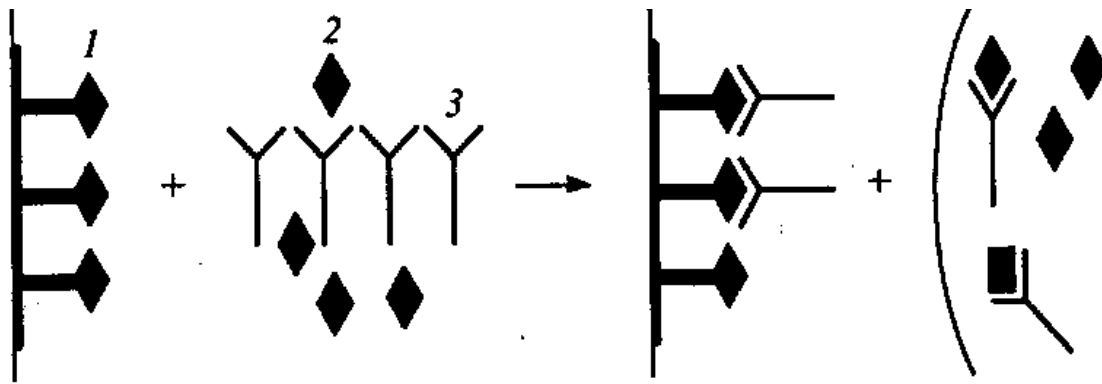

Fig. 2. The scheme of the competitive (indirect) assay using piezoelectric immunosensors: 1 - hapten-protein conjugate; 2 - hapten; 3 - antibody

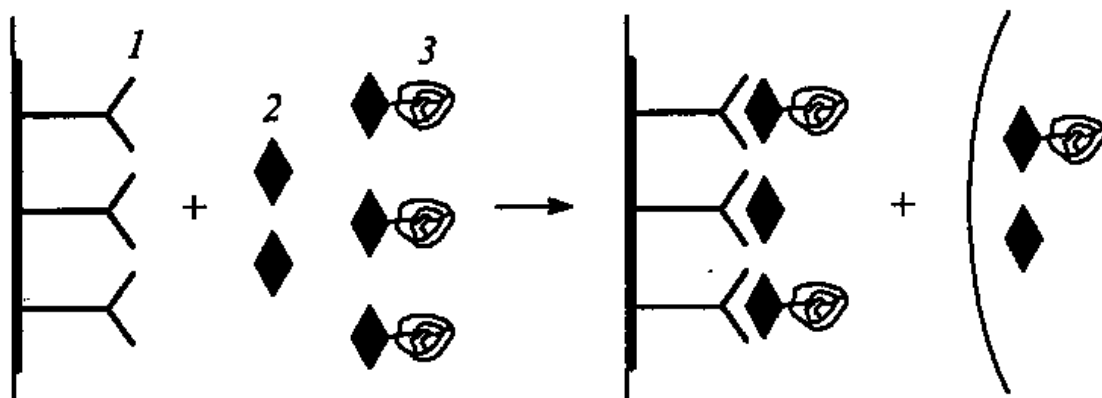

Fig. 3. The scheme of the alternative competitive assay using piezoelectric immunosensors: 1 - antibody; 2 - hapten; 3 - hapten-protein conjugate

Conjugated and free haptens are equally probably bound with the active sites of immobilized antibodies. Therefore, the lower the concentration of free analyte in a sample, the greater the conjugated hapten attached to the sensor's receptor layer. Thus, the sorption of the conjugated analyte provides for a significant amplification of the registered signal. Despite a lower sensitivity, the alternative method is characterized by a wider range of determined concentrations in comparison with the competitive assay.

The displacement assay has been successfully used to characterize the stability of the affine complexes (antibody - antigen, DNA - protein, DNA - RNA, etc.), to study the kinetics of dissociation, and to solve a number of problems dealing with analyte concentration determination. While the competitive assay is preferable for determining low concentrations of small molecules, the **displacement** assay is more convenient for detecting macromolecules. The principle of determination consists of measuring the heterogeneous complex's mass reduction as a result of dissociation under the influence of an excess of one of the components. The analysis is carried out in two stages (Fig. 4).

An example of this type of immunoassay may be the determination of *Listeria monocytogenes* (Minunni et al. 1996) micro-organisms in milk (at $2.5 \cdot 10^5 - 2.5 \cdot 10^7$ cells ml^{-1}). The decrease of the frequency of the sensor is caused by binding specific antibodies in a sample of milk with a protein antigen extracted from *L. monocytogenes* cells and pre-immobilized on the electrode surface. In the second stage the *L. monocytogenes* cells additionally introduced into the

sample of milk cause the displacement of antibodies in immune complex. The number of displaced antibodies is directly proportional to the concentration of *L. monocytogenes* cells in the sample. A similar method was proposed to determine the *P. aeruginosa* bacteria in samples of milk and drinking water (Bovenizer et al. 1998).

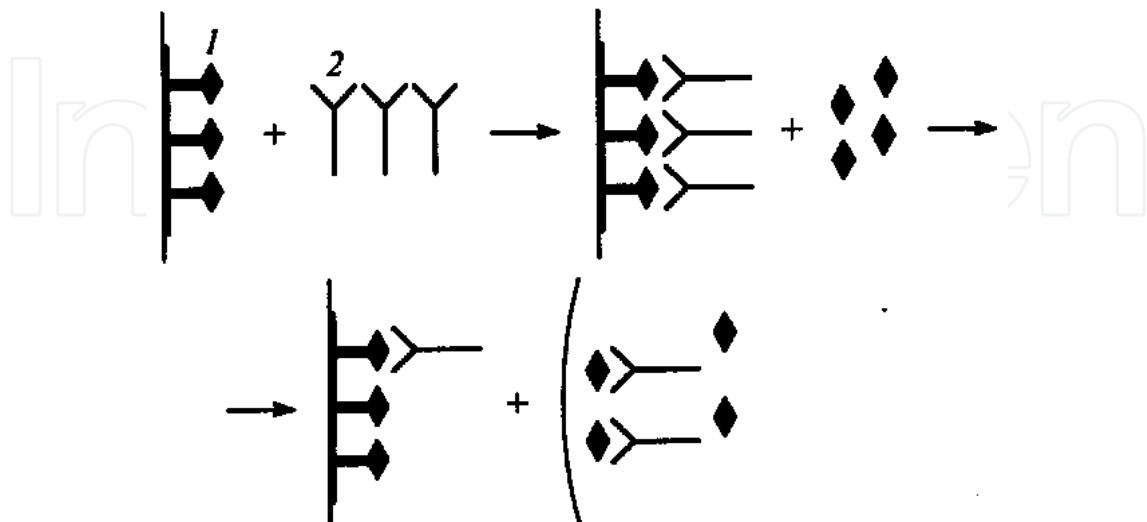

Fig. 4. The scheme of the displacement assay using piezoelectric immunosensors: 1 - antigen, 2 - specific antibody

The **sandwich assay** is carried out in two stages with the use of two types of antibodies (U.S. Patent, 4,314,821 1982). In the first stage the antibodies immobilized on the electrode surface are bound with the analyte, in the second stage the "sandwich" structure is formed with other types of antibodies being additionally introduced (Fig. 5). A method for determining human serum albumin based on the formation of the complex with two types of antibodies can serve as an illustration of the successful application of the sandwich assay (Saber et al. 2002). In this example the analytical signal of the sensor is 3 times higher than the same value obtained by the direct detection.

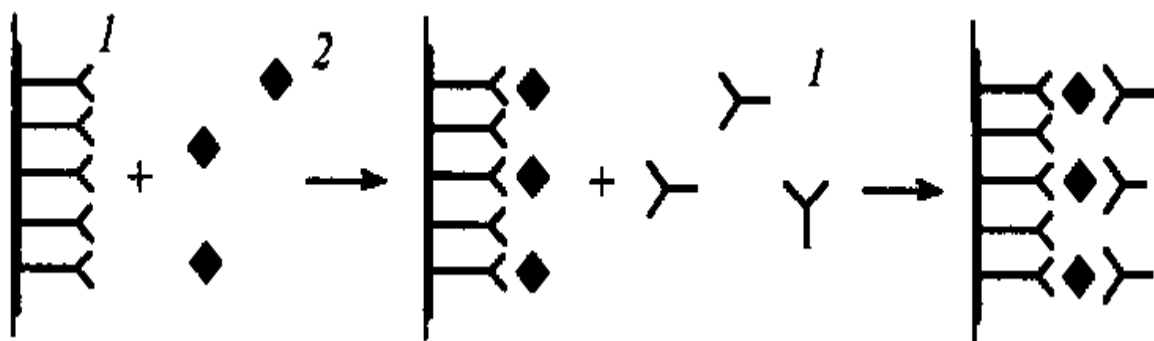

Fig. 5. The scheme of the sandwich assay using piezoelectric immunosensors: 1 - specific antibody; 2 - antigen

In order to reduce the detection limit other methods are used along with the sandwich assay that will increase the value of the analytical signal, e.g. modification of reagents with nanoparticles of different nature (secondary antibodies, metal colloidal particles, polymers nanoparticles and liposomes), which significantly increase the size and mass of the detected

complexes formed at the solid phase (Aizawa et al. 2001, Kim et al. 2007, Chu et al. 2006). In (Su et al. 2000), such methods are marked as a separate kind of analysis, namely the analysis with signal amplification (**mass amplified assay**) (Fig. 6.).

The application of secondary (anti-species) antibodies that interact with the antibodies of the immune complex increases the analytical signal and decreases the detection limit only 1.5 - 2 times, since the mass of secondary antibodies does not exceed 150 kDa. For example, the detection limit of steroid hormone was thus reduced from 12 to 7ng ml⁻¹ (Kubitschko et al. 1997). The mass-amplified assay is operated in two stages. In the first stage the immobilized antigen is bound with defined antibodies. In the second stage - after the removal of antibodies unbound during the first stage - secondary antibodies are introduced which are bound only to specific antibodies. An example of using this method is the determination of allergen-specific immunoglobulin (IgE) in serum of patients with the symptoms of allergic dermatitis (Su et al. 2000). An allergenic protein is immobilized on the surface of the sensor's electrode. In the first stage antibodies of different classes were bound on the surface of the receptor's layer during the contact of the sensor with the patient's blood serum sample. In the second stage the differentiation of antibodies after adsorption of secondary antibodies to human IgE in the process of contact with the sensor was carried out. The differentiation of allergen-specific antibodies (IgE) from other classes of immunoglobulins (IgG and IgM) contained in blood serum is possible after application of these secondary antibodies.

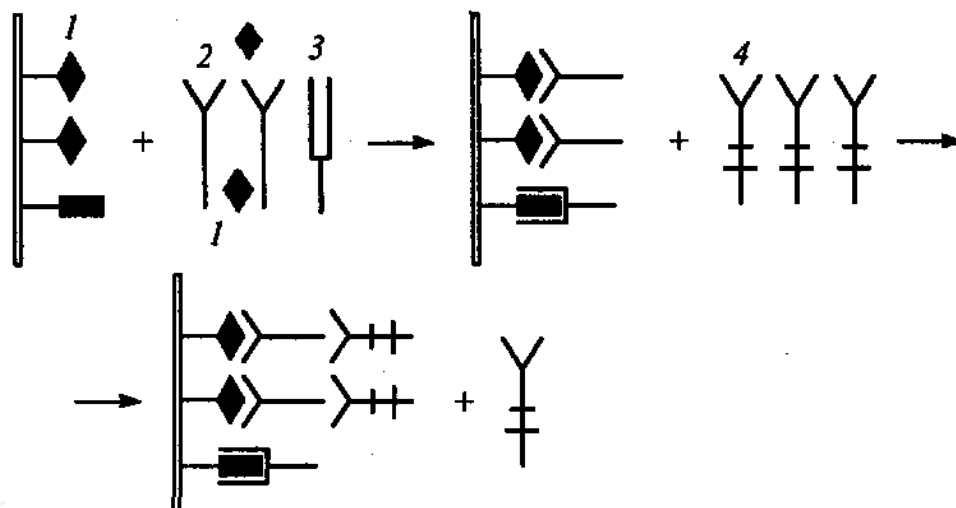

Fig. 6. The scheme of the competitive assay with signal amplification by secondary antibodies using piezoelectric immunosensors: 1 - hapten; 2- anti-hapten antibodies; 3 - non-specific antibody; 4 - secondary antibody

A more significant reduction in the detection limit of analytes (Aizawa et al. 2001, Kim et al. 1996, Liu et al. 2007, Grieshaber et al. 2008, Reyes et al. 2009, Han et al. 2011, Wei et al. 2010, Kim et al. 2010) was observed in the application of colloidal particles of gold, lead, cadmium or zinc sulphides, chromium, titanium and iron oxides, as well as composite particles based on liposomes or latex modified by antibodies.

The colloidal particles modified by antibodies can be applied in all types of analysis reviewed above with the purpose of increasing the signal of the sensor. For example this approach was applied to the determination of the *E. coli* bacteria in the range of 10⁶-10⁸ cells ml⁻¹ (Liu et al. 2007).

Antibodies immobilized on the electrode of the sensor interacted with *E. coli* bacterial cells in the analyzed sample. After that the particles of latex with bound *E. coli*-antibodies were introduced into the reaction mixture to form a sandwich complex with cells that had already been bound with antibodies on the surface of the electrode of the sensor.

Thus, the application of nanoparticles of various masses makes it possible to increase the signal and to change the detection limit of analytes in the sample. However, in choosing the nanoparticles it is necessary to exclude their non-specific interactions with the components of the sample which lead to a distortion of the results of the analysis.

3. Application of piezoelectric immunosensors for medical diagnostics

Various metabolic biomarkers (substances that appear in biological fluids and tissues of the human body during the development of many somatic and infectious pathological processes) can be used in medical and biological research. The determination of these substances allows for diagnosis of diseases at early stages. An urgent problem in the clinical analysis is the need to detect single cells and micro-organisms. In this connection, along with speed, high sensitivity and selectivity, one of the main requirements in performing a large number of routine analyses is the simplicity in preparation of samples for the analysis. Piezoelectric immunosensors are used primarily to identify markers associated with oncological, cardiovascular, autoimmune, allergic and infectious diseases. The nature of molecular markers is quite diverse – they are specific proteins (antibodies, enzymes) and non-specific protein molecules, glycoproteins and glycoconjugates, modified alkaloids, hormones, steroids, drugs and other high- or low-molecular metabolites (Wu et al. 2007, Simon 2010, Martínez-Rivas et al. 2010, Bohunicky et al. 2011, Keusgen 2002, Malhotra et al. 2003, Georganopoulou et al. 2000, Mascini et al. 2008). In addition, sensors can be used to identify microorganisms – bacteria, viruses, and phages. Let us review in more detail the results of research on the sensors for determining the most important groups of biomarkers.

3.1 Tumour markers

Oncological diseases are still the most common threatening ailments, therefore it is not surprising that the search continues for not only new pharmaceutical products but diagnostic methods facilitating the detection of pathology at early stages.

In order to identify certain types of cancer so-called tumour markers are used, conventionally divided into specific and non-specific ones. Tumour markers are complex substances, mainly glyco- or lipoproteins, that are produced by tumour cells much more intensively than normal ones (Wu et al 2007, Guillo et al 2008, Justino et al. 2010). Usually the present marker is determined by a blood test giving a positive result in the presence of malignancy. Different tumour cells produce a variety of markers with different chemical structure.

In creating immunosensors much attention is paid to immobilization of receptor biomolecules in the formation of the detecting layer whose quality determines the basic characteristics of the sensor (Ding et al. 2007, Chang et al. 2010), namely sensitivity, selectivity and stability (reproducibility of measurements and stability for repeated application of the biolayer). The creation of "bioreactors" with high-density and spatial availability of binding sites of receptor biomolecules is a new approach to obtaining detecting

electrode coatings of piezoelectric resonators, which allows multiple determinations without the regeneration of the sensor's biolayer.

The largest number of piezoelectric immunosensors presented in the literature is intended for the detection of such specific antigens as the marker of ovarian carcinomas CA 125; pancreatic cancer CA 19-9 and prostate specific antigen (PSA); carcinoembryonic antigen (CEA) that appears with carcinoma of the cervix or with the developing fetus. In order to determine low concentrations of tumour markers, various techniques aimed at increasing detection sensitivity are used. One of the methods of immobilizing bioreceptor molecules is to use nanoparticles of various nature - magnetic (Chen et al 2007, Wei et al. 2010) or gold (Tang et al. 2006, Tang et al. 2008, Uludağ and Tothill 2010), as well as calixarene (Lee et al. 2003).

Magnetic nanoparticles based on $\text{CoFe}_2\text{O}_4/\text{SiO}_2$ are used to obtain a detection layer containing specific antibodies to SEA (Chen et al 2007). It is possible to determine carcinoembryonic antigen using this sensor in the range of $2.5 - 55 \text{ ng ml}^{-1}$ with the detection limit of 0.5 ng ml^{-1} . Since the normal concentration of tumour marker levels does not exceed 2.5 ng ml^{-1} for non-smokers and 5 ng ml^{-1} for smokers, the proposed immunosensor system can detect even a slight increase in the level of antigen in blood, demonstrating stability of work and satisfactory reproducibility of measurements.

In addition to magnetic particles, gold nanoparticles (Tang et al. 2006) and chains on the basis of nanoparticles (Tang et al. 2008) are used to amplify the sensor's signal and increase the number of active sites on the selective surface.

Gold nanoparticles of optimal length with immobilized antibodies are proposed as a biolayer of the sensor (Tang et al. 2008) for the determination of antigen CA 125. These structures are a result of a multi-stage process with the use of 2-aminoethanethiol (AET) bifunctional molecules with amino- and thiol terminal groups and the following reduction of gold by sodium borohydride (Fig. 7).

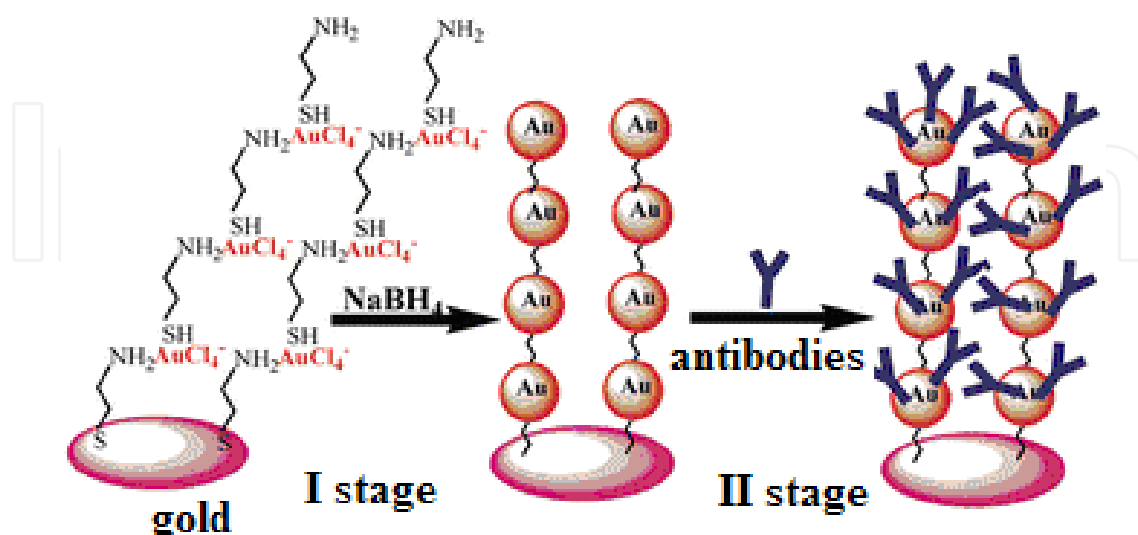

Fig. 7. The formation of the receptor layer on the surface of the gold electrode: Stage I - nano-chains generation of molecules HAuCl_4 and AET; Stage II - immobilization of antibodies (Tang et al. 2008).

In the process of the preparation of the biolayer the AET solution (pH 4.5) is put on the clean gold surface of the electrode and exposed for 2 hours at 4°C. Adjustment of AET molecules is achieved by coordinating bindings between sulphur and gold atoms. Chains from gold nanoparticles are formed as a result of multiple successive putting the HAuCl_4 solution and AET due to the binding of ions $[\text{AuCl}_4]^-$ with NH_2^- and SH -groups of AET and the formation of self-organizing layers $\{\text{AuCl}_4^-/\text{AET}\}$. This technique of obtaining electrode coating provides the sequence of layers, and after the reduction of anions $[\text{AuCl}_4]^-$ by the sodium borohydride (NaBH_4) water solution chains from gold nanoparticles are formed. The process is accompanied by a change in the colour of the surface from yellow to deep red. The addition of the antibody solution results in fixation of the molecules of specific immunoglobulins with the space-available active sites on the gold particles.

Therefore the presence of gold nanoparticles and nanochains (nanosequences) on the surface of the sensor's electrode increases the number and density of immobilized antibodies, as well as facilitates the formation of a three-dimensional structure in the biolayer, as confirmed by the methods of atomic force and electron microscopy at stepwise formation on the surface of the receptor layer. The detection layers based on gold nanoparticles and nanochains (nanosequences) exhibit high selectivity which is confirmed by the analysis of solutions containing interfering antigens such as CEA, CA 199, α -fetoprotein and hepatitis B surface antigen. It is shown that even high concentrations of impure antigens do not significantly affect the determination of CA 125, whose concentration in serum does not normally exceed 25 U ml^{-1} . The biolayer obtained with the use of gold nanoparticles has high capacity, satisfactory stability and provides good reproducibility of the analytical signal of the sensor. The linear range of determined concentrations of CEA and CA 17 125 (Tang et al. 2008) is $3.0 - 50 \text{ ng ml}^{-1}$ and $1.5 - 180 \text{ U ml}^{-1}$ respectively, with the detection limit being 1.5 ng ml^{-1} and 0.5 U ml^{-1} . The results of the analysis of human blood serum obtained with the use of piezoelectric immunosensors correlate with those of enzyme immunoassay. However, an advantage of sensor technologies is higher speed and simplicity of measurement, eliminating the stages of the introduction of an enzyme label, of separation and washing, which is important when conducting a large number of clinical tests.

A new approach to the formation of the detection layer with a higher capacity is realized in the design of the sensor, proposed for determining carbohydrate antigen CA 19-9, which is a marker of pancreatic (Ding et al., 2008, Tanaka et al. 2000), colon (Nakayama et al., 1997), liver (Uenishi et al. 2003) cancer. The possibility of using organo-inorganic hybrid nanomaterials based on hydroxyapatite $[\text{HA}, \text{Ca}_{10}(\text{PO}_4)_6(\text{OH})_2]$ and lysine is shown. Hydroxyapatite is the main inorganic component of bones, characterized by exceptional biocompatibility and therefore not causing immune rejection or toxic effects on the body (Ding et al., 2008). However, the use of pure materials on the basis of hydroxyapatite is hampered by instability, fragility and low solubility of the mineral. The addition of an organic component improves physical and chemical properties (such as permeability, solubility, etc.). The biosensor's receptor layer is formed on the basis of specific antibodies attached to a hybrid nanocomposite consisting of poly-L-lysine/hydroxyapatite/carbon nano-tubes (Fig. 8).

In order to obtain the coating, the resonator is initially treated with mercaptopropionic acid, which leads to the functionalization of the gold electrode surface by carboxyl groups as a monolayer. Further addition of 1-(3-dimethylaminopropyl)-*N*'-ethylcarbodiimide (EDC) and *N*-hydroxysuccinimide (NHS) provides the activation of carboxyl groups. After

washing and drying the resonator a suspension composed of poly-L-lysine, hydroxyapatite, carbon nanotubes is put on the surface of the resonator's electrode and exposed for 2 h at 37°C, then antibodies to CA 19-9 are immobilized after the washing. The biosensor with nanocomposite detecting coating provides the direct registration of the immune complex which is formed in the process of the sorption of the tumour marker (a high molecular glycoprotein with the molecular weight of approximately 20.000) as an increase of the mass of the biolayer in the range from 12.5 to 270 U ml⁻¹. The content of CA 19-9 antigen in healthy people is less than 37 IU ml⁻¹, so a piezoelectric immunosensor can detect even slight deviations from the norm and diagnose the disease at an early stage.

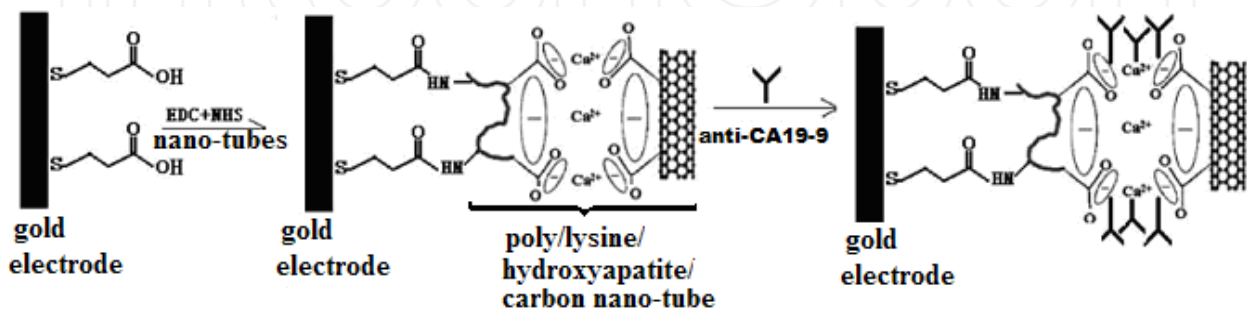

Fig. 8. The formation of the biolayer based on antibodies to CA 19-9, immobilized with poly-L-lysine/hydroxyapatite/carbon nano-tubes (Ding et al. 2008).

The combination of the methods reviewed above (application of new hybrid materials on the basis of gold nanoparticles and hydroxyapatites (Ding et al. 2007) and subsequent immobilization of antibodies) increases the sensitivity and widens the range of concentrations of the marker. The authors have shown that the use of selecting surface of the sensor with nanoparticles leads to the increase of the biolayer's binding activity with immobilized antibodies to α -fetoprotein (Ab-AFP). The immunosensor is designed to detect α -fetoprotein (a glycoprotein with a molecular weight of 65 - 70 kDa, which is a marker of trophoblastic tumors (Chou et al. 2002) in the range of 15.3 - 600.0 ng ml⁻¹).

Along with new ways of immobilization, traditional approaches to the formation of the bio-detecting layer of the sensor still remain popular. Methods of immobilizing specific monoclonal Ab-AFP (physical sorption, attachment to substrates based on protein A and concanavalin A, cystamine with the use of a cross-reactant - glutaraldehyde - GA) are studied in detail. The highest stability was shown for the biolayer obtained using the self-organizing monolayers on the basis of cystamine. The sensor provides the detection of even minor deviations of AFP from the norm (20 ng ml⁻¹ in human serum), as the linear range of determined concentrations of glycoprotein corresponds to 0.1-100 ng ml⁻¹ (Tatsuta et al. 1986). The results of determining AFP in serum samples correlated with the data of the radioimmunoassay.

In order to increase the stability of the biolayer a method of immobilizing protein molecules (antigens or antibodies) is proposed using the bifunctional linkers and calixarenes "Prolinkers" (Lee et al. 2003). It is shown that the activation of a solid surface by Prolinkers (Fig. 9) allows bioreceptor layers to be obtained with high density and vertical position of the molecules and hence a high concentration of spatially available binding sites for immobilized antigens or antibodies.

The active sites of the receptor molecules are not affected, which usually occurs in immunoglobulin covalent fixing. Immobilization is accomplished by including proteins in the calixarene cavity with the formation of the host-guest complex, as well as a result of hydrophobic interactions. The fixation of the linker on the metal surface is achieved by means of sulphur atoms or carbonyl groups comprising Prolinker B or A, respectively. The considered method of forming the bilayer provides high sensitivity of determination of such tumour markers as hCG (chorioiditic gonadotropin), CEA, α -fetoprotein, ferritin, etc. at the fg ml^{-1} level

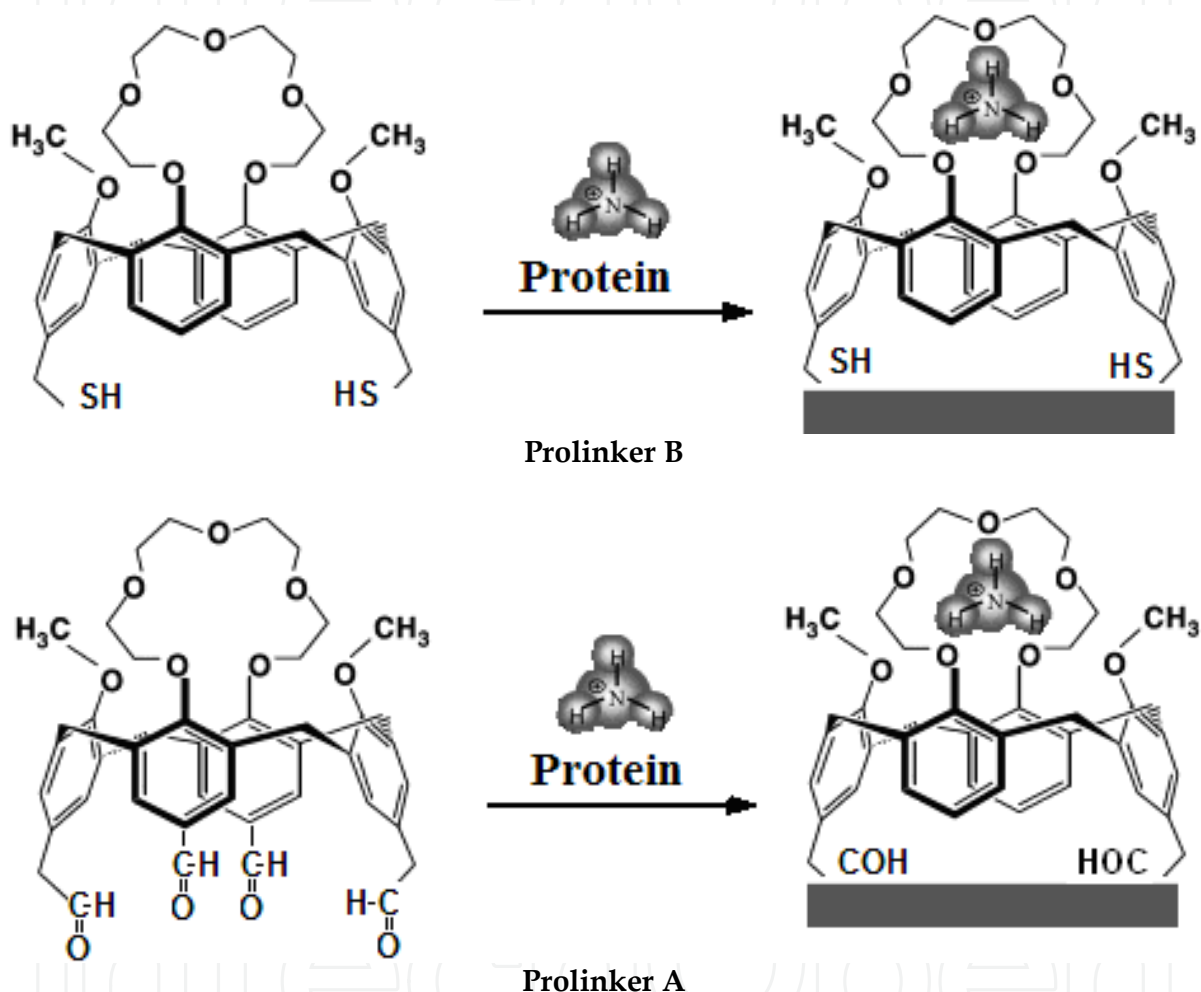

Fig. 9. The scheme for obtaining the bilayer based on Prolinkers (Lee et al. 2003)

A flow-injection sensor has been designed to determine mezotelin (a glycoprotein with the weight of 40 kDa) which like the C 19-9 antigen is associated with pancreatic cancer processes (Corso et al. 2006) and is present in blood practically in all pancreatic adenocarcinomas. The detecting coating of the sensor is obtained on the basis of mezotelin-specific antibodies immobilized on the self-organized alkanthiol monolayers.

The increase in sensitivity and reliability of tumour marker determination is achieved not only by the formation of the receptor layer with a high concentration of available binding sites but also by improving the methods of determining the equipment, which allow monitoring of immunochemical interactions in real time. The improvement of the "signal-

noise" ratio and the reduction of the contribution of nonspecific interactions occur when taking measurements using a system of two sensors: the indicator sensor and the comparison sensor, both placed in individual flow cells (Fig. 10).

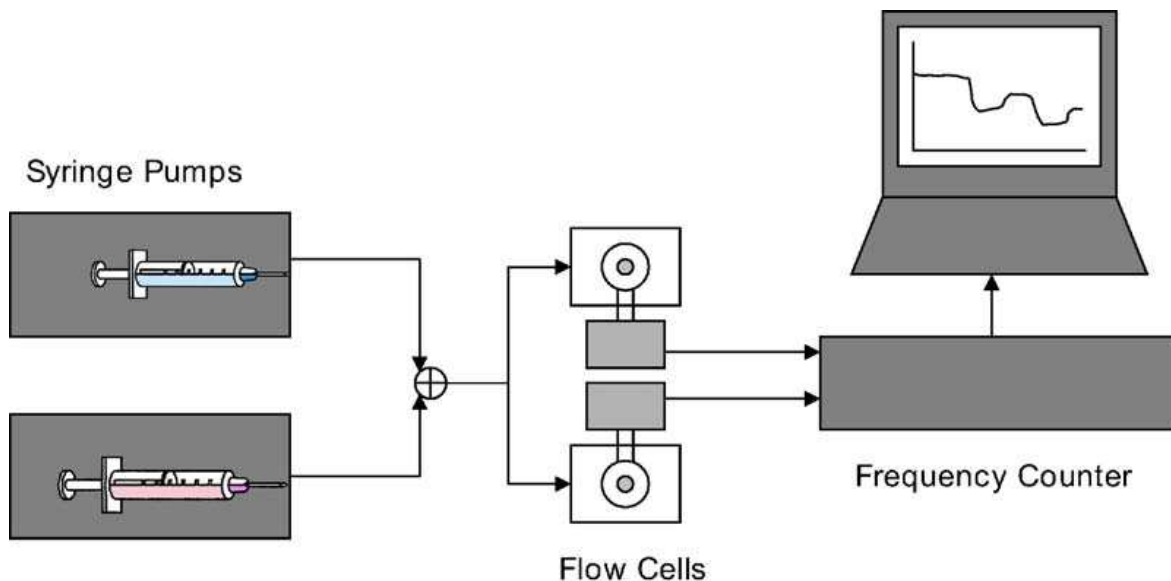

Fig. 10. The diagram of the device for performing the flow analysis (Corso et al. 2006)

The use of two syringe pumps (to feed the carrying solution and the sample solution) reduces pulsations in the system and allows the stabilization of the sensor signal, while determining mezotelin at the nano-level (Corso et al. 2006).

As seen from the above examples, piezoelectric immunosensors are a highly sensitive tool for detecting low concentrations of tumour markers and for identifying the disease at early stages. Most commonly, however, sensors are used for detecting recurrences of cancer previously diagnosed and treated for. This is due to the nature of antigenic tumour markers which can give false positive reactions.

The reliability of diagnosis increases with the use of biochips and multisensor systems consisting of a set of sensors for determining individual tumour markers and metabolites, complicating the diagnosis of cancer. Thus, a multi-sensor system is described designed for highly specific determination of several tumour markers in serum, such as α -fetoprotein, CEA and carcinoma antigen, prostate-specific antigen (Zhang et al. 2007). The possibility of the simultaneous determination of several tumour markers, a perfect combination of high speed and relatively low cost makes the approach attractive compared with traditional diagnostic laboratory methods. The detection limits of PSA, AFP, CEA, and CA125 are 1.5 - 40 ng ml⁻¹, 20 - 640 ng ml⁻¹, 1.5 - 30 mg ml⁻¹, 5 - 150 IU ml⁻¹, respectively. The comparison of the results of the analysis of clinical samples using the multichannel immunosensor and the chemiluminescence method showed no significant differences.

In spite of the fact that specific biomarkers are more informative because they indicate the emergence of specific forms of pathological processes, non-specific tumour markers, however, such as human serum albumin (HSA) and ferritin have also proved useful in assessing the health status of patients.

A number of studies are aimed at creating a piezoelectric immunosensor for the determination of HSA. The focus is on methods of immobilization, as well as increasing the sensitivity of determination from $\mu\text{g ml}^{-1}$ to ppm (for example, signal amplification due to the use of secondary antibodies in the sandwich-analysis (Sakai et al. 1995) or colloidal particles of latex (Xia et al. 1997)). The simplest way to fix biomolecules is the physical adsorption in that it, unlike covalent bonding, preserves the activity of immunoglobulins. This is due to rather mild conditions of protein immobilization, but the stability of the film coating is low, the mass of the bio-layer is already lower after 2 - 4 measuring cycles. Immunosensors (Muratsugu et al. 1993) make it possible to determine HSA with high sensitivity and selectivity in the range of 0.1 - 100 $\mu\text{g ml}^{-1}$ even in the presence of a nonspecific impurity protein - bovine serum albumin (BSA). Further development of immobilization methods was aimed at increasing the strength of the bio-layer due to a substrate on the basis of calixarenes and synthetic polymers (Sakti et al. 2001), which ensures the sensor's long-term operation in analyzing not only sample solutions but real samples of biological fluids (e.g., urine).

At present, the problems of increasing the sensitivity of determining the HSA and the stability of the sensor are fully understood. Considerable attention is paid to both methods of obtaining the bilayer and ways of amplifying the sensor's analytical signal. This can be achieved by increasing the mass of the heterogeneous immune complex. Secondary antibodies whose mass exceeds that of HSA are used in the sandwich assay to amplify the signal, which leads to lowering the HSA detection limit to 20 ppm. With the same purpose the nano-particles of carboxyethyl cellulose polymer (Xia et al. 1997) are used, thus increasing the sensor signal due to latex agglutination.

Along with the HSA determination considerable attention is paid to the creation of sensors for the determination of another non-specific marker - ferritin, a backup protein the level of which increases during the inflammatory processes in the body. Methods of immobilizing poly- and monoclonal antibodies on the electrode surface have been thoroughly researched. They include: physical adsorption, covalent attachment to substrates on the basis of concanavalin A and protein A, and self-organizing monolayers on the basis of cystamine, cystamine/GA (Chou et al. 2002). It has been shown that the bilayer based on cystamine has the highest stability. The sensors remain active for 15 days and can be used up to 10 times in ferritin linear concentration range of 0.1 - 100 ng ml^{-1} . It should be noted that in order to determine tumour markers, monoclonal antibodies are more frequently used. This increases the reliability of determinations and ousts polyclonal antibodies from the laboratory practice.

In diagnosing leukemia whole cells (leukocytes) circulating in blood (Wang et al. 2006, Zeng et al. 2006) are determined. The receptor coating is formed on the basis of Fab'-SH fragments of specific monoclonal antibodies, thus avoiding overloading the sensor. Performing the analysis in the automatic mode involves the measurement and regeneration of the bilayer in one measurement cycle. The application of 8M of urea as a regeneration solution permits keeping the coating stable for up to 17 measurement cycles. Firm fixation of the fragments of immunoglobulins is achieved through the formation of covalent bonds between the biomolecules and thin-film substrates obtained by plasma polarization of n-butyl amine, on the basis of protein A or gold nanoparticles. The sensor is able to quickly and reliably detect normal cells, leukemic blasts and to determine the concentration of leukocytes in the range of $10^4 - 10^6 \text{ cells ml}^{-1}$.

Thus nowadays piezoelectric immunosensors have successfully proved to be promising tools for express determination of blood cells and tumour markers of different chemical structure and biological specificity.

3.2 Cardiac markers

Cardiovascular diseases leading to the growth of cardiac infarctions and strokes remain one of the main causes of death and disablement throughout the world. Myocardial necrosis is accompanied by the appearance of blood-specific biomarkers – proteins released with the destruction of myocytes: myoglobin, cardiac troponin and specific enzymes – creatine kinase, glycogen phosphorylase BB (GPBB), lactate dehydrogenase, etc. (Casey 2004). Despite a wider application of enzymatic methods of analysis in laboratory diagnostics of cardio-pathology, several works of the recent years have described piezoelectric chemical, bio- and immunosensors for determining biomarkers of non-enzymatic nature – myoglobin (Godber et al. 2005), C-reactive protein (CRP) (Kurosawa et al. 2003, Kim et al. 2009), troponin (Wong-ek et al. 2010, Mohammed and Desmulliez 2011), heparin (Cheng et al. 2002), thrombin, etc.

Bi-sensor systems are being developed in order to reduce the impact of non-specific effects. To change the viscous-elastic properties of the receptor films which influence the comprehensiveness of contact of the vibrating crystal with the surface, which in turn causes errors in calculating the adsorbed mass. Bi-sensor systems on the basis of high-frequency resonators (16.5 MHz) have been developed for determining mioglobin, a cytoplasmatic protein with the weight of 17 kDa, a part of muscular cells (Godber et al. 2007), the presence of which in blood serves as a good diagnostic marker of cardiac diseases (Casey 2004). The receptor layer of the indicator sensor includes anti-mouse-Fc-specific antibodies in the rabbit which are immobilized by means of EDC and NHS. Mouse immunoglobulins G are fixed on the surface of the control sensor to control a non-specific interaction of mioglobin with the surface of the protein. The analytical signal caused by the specific interaction is measured relative to the comparison sensor thus providing the opportunity to differentiate between the normal level of mioglobin in blood (100 ng ml⁻¹) and excess at cardio ischemia because mioglobin concentration directly after infarction reaches 1000 ng ml⁻¹ and more and decreases to 500 ng ml⁻¹ after a time.

The combination of a bi-sensor system and the sandwich assay is directed at increasing the sensitivity in determining C-reactive protein (McBride and Cooper 2008), which is a multifunctional biomarker of an acute phase playing an important role at inflammations, in protection against alien agents, at necroses and autoimmune processes. For a number of years the exceeding concentration of CRP by over 5 mg l⁻¹ marked the absence of any systemic inflammatory process in the organism. Now, new data on the diagnostic possibilities of CRP, including participation in the development of various pathologies have been obtained, particularly vascular diseases. The determination of "background" or "base" (hsCRP) concentrations in biological liquids can be used to forecast the degree of risk from acute myocardial infarction, a brain stroke, and sudden death in people not suffering from cardiovascular diseases. Expansion of the diagnostic status of CRP has demanded the development of methods of high-sensitive determination of a biomarker. It is recommended to use the calibration graph obtained with the application of human CRP standard solutions

(0.3 - 116 ng ml⁻¹) on the basis of diluted horse blood to decrease irregularities. Sheep anti-CRP are immobilized on the surface of the indicator sensor, and purified sheep immunoglobulins G are immobilized on the control sensor. Such an approach enhances the reliability of revealing patients predisposed to cardiovascular diseases. The use of secondary antibodies in the second stage of the analysis promotes the increase in specificity and sensitivity of determination in comparison with the results of the traditionally used ELISA.

The works of Japanese researchers are devoted to determining CRP and providing the quantitative characteristic of affinity of monoclonal antibodies and their Fab'-fragments (Kurosawa et al. 2002 and 2004). They studied the influence of the nature of thin plasma-polymerized coatings of gold electrodes (styrene, allylamine and acrylic acid) on the orientation of immobilized antibodies and their fragments. It was shown that the highest analytical signals are observed for bilayers on polyallylamine substrates. Processing the electrode by a polymer based on phosphorylcholine and methylacrylate derivatives increases the affinity of the receptor molecules to the determined substance and decreases the reaction activity in relation to non-specific proteins of human serum. The highest values of affinity constants were seen for Fab'-fragments in comparison with the whole antibodies. The application of fragments of antibodies allows the achievement of the linear range of defined concentrations of C-reactive protein of 0.001 - 100 µg ml⁻¹ (Kurosawa et al. 2004) in serum samples.

The suggested approaches increase both the speed of diagnostics and the sensitivity and reliability of determining cardiac markers.

3.3 Detection of infections

The possibility of the spread of epidemic-causing pathogenic germs and the threat of bioterrorism necessitate the development of new express methods for detecting pathogens for early detection of cases and localization of sources of infection. Control over the spread of extremely dangerous, acute intestinal, septic, sexual, viral diseases (influenza, hepatitis, HIV) involves not only the identification of bacteria or viruses in biological fluids of patients but also the determination of markers of infection – specific antibodies and in some cases – toxins (proteins, glycoproteins or glycolipids) produced by pathogenic causative agents.

The application of piezoelectric immunosensors for determining microbial and bacterial antigens, toxins and antibodies (which are large analytes) proved to be more promising not only compared with the traditional methods of analysis (microbiological, immunochemical and molecular-genetic) but also with other biosensors. This is explained by peculiarities of gravimetric detection which does not require the introduction of biochemical markers for the registration of binding. This greatly simplifies and speeds up the analysis procedure. Piezoelectric micro- and nano-weighing makes it possible both to register the mass of a microbe or a biopolymer at µg or ng and to calculate the number of individual cells or viruses according to their mass and size in the concentration range of 10² - 10⁷ cells ml⁻¹ or 10⁶ - 10¹⁰ particles ml⁻¹, respectively (Pathirana et al. 2000, Konig and Gratzel 1992).

In determining microorganisms the direct analysis is used most commonly, while the sandwich and the displacing assays and the analysis with the amplification of the sensor signal are used to increase the sensitivity of determination.

The characteristics of piezoelectric immunosensors for determining microorganisms and protein molecules are given in tables 1-3.

Analyte	Method of immobilizing receptor molecules or assay design (detection format)	Linear range. Detection limit	References
<i>Escherichia coli</i> O157:H7	Immobilization on gold electrode on the basis of N-hydroxysuccinimide and 16-mercaptohexadecanic acid	$10^3 - 10^8$ CFU ml^{-1} -	Su and Li 2002
<i>Escherichia coli</i>	Covalent immobilization of Ab cross-linked by GA	$1.7 \cdot 10^5 - 8.7 \cdot 10^6$ CFU ml^{-1} $3 \cdot 10^4 - 3 \cdot 10^7$ CFU ml^{-1}	Adanyi et al. 2006
<i>Escherichia coli</i> O157:H7	Biotylated Ab immobilized on monolayers on protein A	$10^5 - 10^7$ CFU ml^{-1} 10^2 CFU ml^{-1}	Liu et al. 2007
	Ab immobilized on monolayers on the basis of 16-mercaptohexadecanic acid (MHDA) with NHS	- $2.0 \cdot 10^2$ CFU ml^{-1}	Wang et al. 2008
<i>Francisella tularensis</i>	Ab immobilized <i>via</i> protein A	$10^4 - 10^9$ CFU ml^{-1} ; 10^5 CFU ml^{-1}	Pohanka et al. 2007
	Ab immobilized to monolayer cystamine/GA	- -	Pohanka et al. 2007
<i>Mycobacterium tuberculosis</i>	Immobilization of Ab on silver electrode <i>via</i> protein A	$10^5 - 10^8$ cells ml^{-1} . 10^5 cells ml^{-1}	He and Zhang 2002
<i>Salmonella sp.</i>	Direct detection, Ab immobilized with cross-linker	ABCD-serogroups $10^5 - 10^8$ cells ml^{-1}	Wong et al. 2002
<i>S. typhimurium</i>	Ab immobilized on the films of PEI-GA	- $1.5 \cdot 10^9$ CFU ml^{-1}	Babacan et al. 2000
	Ab immobilized on the films of protein A	- $1.5 \cdot 10^9$ CFU ml^{-1}	
<i>Staphylococcus aureus</i>	Ab covalently immobilized by GA to self-assembled monolayer of thiolamin	$10^5 - 10^9$ cells ml^{-1} -	Boujday et al. 2008
<i>Treponema pallidum</i>	Ab immobilized on the latex particle; latex agglutination	- -	Aizawa et al. 2001
<i>Yersinia enterocolitica</i>	Direct detection, Ab immobilized <i>via</i> concanavalin A, sulfated polysaccharide	$(0.30 - 4.90) \cdot 10^4$ cells ml^{-1} $0.04 \cdot 10^4$ cells ml^{-1}	Kalmykova et al. 2007
<i>Vibrio cholera</i> 0139	Adsorption of Ab	- 10^5 cells ml^{-1}	Carter et al. 1995

Table 1. Piezoelectric immunosensors for the determination of bacteria

Most of the modern sensors are designed to determine the causative agents of a widespread group of intestinal diseases – bacteria *E. coli* (Plomer et al. 1992, Su and Li 2002, Adanyi et al. 2006, Liu et al. 2007, Wang et al. 2008, Shen et al. 2011, Jiang et al. 2011, Li et al. 2011), *Listeria monocytogenes* (Minunni et al. 1996, Vaughan et al. 2002, Wang et al. 2008), *Salmonella* sp. (Su et al. 2001, Su et al. 2005, Yang et al. 2009, Park and Kim 1998, Wong et al. 2002, Fung and Wong 2001, Ying-Sing et al 2000), *Vibrio cholera* (Carter et al. 1995), *Yersinia enterocolitica* (Kalmykova et al. 2007 and 2008), viruses (Konig and Gratzel 1992). (*Adenovirus*, and *Rotavirus*), as well as toxins (e.g. staphylococcus toxin) (Harteveld et al. 1997, Salmain et al. 2011).

Analyte	Method of immobilizing receptor molecules or assay design (detection format)	Linear range. Detection limit	References
Adenovirus	Direct assay, Ab immobilized via protein A, siloxane, polyethylenamine	$1 \cdot 10^6 - 1 \cdot 10^{10}$ particulars ml ⁻¹ —	Konig et al. 1992
Hepatitis virus A, B	Direct assay, Ab immobilized via protein A	— 10^5 particulars ml ⁻¹	Zhou et al. 2002
Hepatitis virus C (HCV)	RNA of HCV immobilized via avidin (streptavidin) to a monolayer of cystamine	— —	Skladal et al. 2004
Human cytomegalovirus	Competitive definition, monolayers of poly-L-lysine and tiosalicylic acid	$2.5 - 5 \mu\text{g ml}^{-1}$ $1 \mu\text{g ml}^{-1}$	Susmel et al. 2000

Table 2. Piezoelectric immunosensors for the determination of viruses and bacteriophages

Salmonellosis diagnostics is successfully carried out with the help of sensors with the biotesting layer based on both common and thiolated antibodies (Park and Kim 1998, Kim et al. 2003), which are specific for the determined bacteria (*S. typhimurium*, *S. paratyphi*, *S. enteritidis*). Along with the traditional ways of antibody immobilization (physical adsorption, specific binding to protein A or covalent attachment using a bifunctional cross-linker to the Langmuir-Blodgett films) in obtaining the biolayer self-organizing monolayers on polyethyleneimine (Wong et al. 2002, Babacan et al. 2000) and electropolymerization techniques are used.

It should be noted that the method of electrode coating does not significantly affect the sensitivity of determining bacterial pathogens ($10^5 - 10^9$ cells ml⁻¹), but significantly increases the reproducibility and stability of analysis. For example, a sensor has been designed to determine the *Staphylococcus aureus* bacteria causing purulent-septic diseases (Le et al. 1995, Boujday et al. 2008). It is designed on the basis of the chromatographic phase (YWG-C₁₈H₃₇) with antibodies immobilized with glutaraldehyde and is meant for repeated use and long-term storage. The sensor (Le et al. 1995) can be used up to 15 times and stored for months without a decrease in biomolecule activity. However, it is characterized by a few cases of cross-binding with bacteria of other genera: *P. aeruginosa*, *S. epidermidis* *E. coli*. The formation of the biolayer on the surface of an electropolymerized film increases the resistance of sensors that can be stored for more than 5 weeks. The ability to maintain constant values of the electrode's potential and current provides for obtaining receptor coatings with identical

thickness, mass and distribution of functional groups, which is very important for commercial production of sensors.

Despite the fact that most strains of *E. coli* are not harmful to humans, some serotypes (e.g. K12, O157: H7) cause serious food poisoning. Sensors are suggested for the "dip and dry" analysis with a receptor layer on the basis of antibodies to *E. coli* K12, immobilized on a

Analyte	Method of immobilizing receptor molecules or assay design (detection format)	Linear range. Detection limit	References
Ab to bacteria <i>F. tularensis</i>	Direct detection, Antigens are attached by means of GA to the cystamine-monolayer on a gold electrode	Titer 40 - 160 -	Pohanka et al. 2007
Ab to HIV	Direct detection synthetic HIV-peptide or recombinant proteins are immobilized	Tests yes/no	Kosslinger et al. 1995 and 1998
Ab to parasites <i>Shistosoma japonicum</i>	Antigens (SjAg32, mass 32kD) covalently immobilized on 3-mercaptopropionic SAM-to you (MPA) using EDC/NHS	3.6 - 42.0 $\mu\text{g ml}^{-1}$ -	Wu et al. 2003
Ab to bacteria <i>Y. enterocolitica</i>	Direct assay, LPS immobilized on a lipid substrate	3 - 110 $\mu\text{g ml}^{-1}$ 1.3 $\mu\text{g ml}^{-1}$	Kalmyken et al. 2007
Immuno-globulin E	Direct assay, Physical sorption of protein antigen	0 - 300 ME ml^{-1} 0.1 - 25 $\mu\text{g ml}^{-1}$ 0.15 - 17.5 $\mu\text{g ml}^{-1}$ -	Su et al. 2000
Immuno-globulin E	Direct assay, Affine immobilization to aptomer on the basis of ssDNA	- 0.05 nmol ml^{-1}	Liss et al. 2000
Human IgG	Direct assay, Chemo sorption of protein complex IgG-Ab on polystyrene substrate	- 5 $\mu\text{g ml}^{-1}$	Liu et al. 2003
Surface antigen of Hepatitis B	Direct assay, Ab linked by method of cross-linking to cystamine monolayer	- 4.7 nmol l^{-1}	Chen et al. 2002
Cholera toxin	Sandwich method, amplified by ganglioside-modified liposomes	- 0.0001 nmol l^{-1}	Alfonta and Wilner 2001
Staphylococcus enterotoxin (SEB)	Competitive assay, Ab immobilized on gold electrode	- 0.1 $\mu\text{g ml}^{-1}$	Harteveld et al. 1997

Table 3. Piezoelectric immunosensors for determination of protein molecules

substrate of protein A (Plomer et al. 1992) and monolayers on alkanthiols (Su and Li 2002). The detection limit of bacteria *E. coli* O157: H7 is 10^3 CFU ml⁻¹. In order to increase the sensitivity of the determination of *E. coli* O157: H7 streptavidin-conjugated nanoparticles gold (145 nm), magnetic, silica and polymer nanoparticles of 30 - 970 nm, immunomagnetic nanoparticles (BIMPs) and affinity-purified antibodies against *E. coli* treated with biotin (Liu et al. 2007, Shen et al. 2011, Jiang et al. 2011) are used. After binding cells with immobilized antibodies nanoparticles of bio-conjugates with streptavidin are injected into the system (Liu et al. 2007), thus amplifying the sensor's signal, with the detection limit of bacteria *E. coli* O157: H7 decreasing to 10^2 CFU ml⁻¹.

Besides the research aimed at determining certain types of bacteria, in microbiological control it is possible to simultaneously determine several of the most dangerous microorganisms belonging to the same family (Kim and Bhunia 2008). It is perspective to apply antibodies against enterobacterial common antigen (ECA) which represents a phospholipid in the outer membrane and characterized by specificity to the whole *Enterobacteriaceae* family comprising the *Salmonella* and *E. coli* genera. Using monoclonal antibodies to ECA, Plomer et al proposed immunosensors for determining any microorganism of the *Enterobacteriaceae* family in the range of 10^4 - 10^6 cells ml⁻¹.

This displacement analysis is recommended for determining the *Pseudomonas aeruginosa* bacteria which cause postoperative or post-burn complications. In order to determine the bacteria directly in the flow of the solution thiolated antibodies (Kim et al. 2004) were used, which increases its service life by more than 10%.

A method has been suggested for flow-injection determination of pathogenic "fridge bacteria" – the *Yersinia enterocolitica* bacteria, O:3 serotype, in aqueous media. The necessity to determine *Yersinia* is caused by the fact that they are agents of an infectious intestinal disease – yersiniosis which considerably influences human and animal pathology. In order to determine the *Y. enterocolitica* bacteria the bilayer of the sensor is formed on immobilized specific antibodies. The comparative evaluation of methods for obtaining the bio-detecting layer of the sensor (absorption of antibodies on metal surfaces, covalent binding with sulfated polysaccharides substrates, concanavalin A, aminosiloxane using glutaraldehyde) has demonstrated the advantage of polysaccharide substrates, which increase the reproducibility of the analytical signal and reduce the detection limit to $0.02 \cdot 10^4$ cells ml⁻¹ (Kalmyken et al. 2007). The widest linear range of determined microorganisms was found for the siloxane bilayer substrate: 0.30 - $4.90 \cdot 10^4$ cells ml⁻¹. The methods of flow-injection determination of the *Y. enterocolitica* bacteria using a piezo-quartz immunosensor with the bilayer based on monoclonal homologous antibodies can reliably detect the presence of microorganisms in aqueous media. The proposed immunosensors can detect bacteria in water solutions with a minimum concentration of $0.10 \cdot 10^4$ cells ml⁻¹.

Despite very rare occurrences of cholera in this day and age, it is an infection which can cause rapid dehydration and death. In order to determine the *Vibrio cholerae* 0139 a highly specific sensor was developed (Carter et al. 1995) showing no cross-interactions with other bacteria, such as *Ogawa*, *E. coli*, *L. monocytogenes* and *S. marcescens*.

Piezoelectric biosensors can be applicable not only in determining individual analytes, but also for the study of biochemical processes (agglutination, hybridization) in real time, as well as of the kinetics of reversible reactions. Such sensors can subsequently be used to

select antibodies as bioreceptor molecules to create immunosensors. For example, researchers deal with the application of monoclonal antibodies against pathogenic *Francisella tularensis* bacteria causing a zoonotic disease – tularemia, as well as bacterial endotoxins to determine specific antibodies (Pohanka et al. 2007).

Viruses. Among all infectious diseases the most complicated problems are associated with viral infections. This is mainly due to the prevalence of viruses, their participation in the processes of immunogenesis, difficulty in diagnoses, so it is equally important to create sensors for the determination of pathogenic viruses (hepatitis, herpes, human immunodeficiency - HIV, etc.).

One of the first researchers who reported on the possibility of detecting not only bacterial, but viral pathogens of diarrhea (*Rotavirus* and *Adenovirus*) in liquid were Konig and Gratsel. The sensors designed by these authors allow the determination of both the microbial pathogens in the range of $1 \cdot 10^6 - 1 \cdot 10^8$ and $1 \cdot 10^6 - 1 \cdot 10^{10}$ virus ml^{-1} , respectively, as a result of direct increment of the mass of the receptor layer. The direct detection is used to determine the herpes viruses 1 and 2, *Varicella-zoster*, *Epstein-Barr* virus at 10^4 virus ml^{-1} (Susmel et al. 2001). In the case of hepatitis A and B, the detection limit is 10^5 viral particles ml^{-1} (Konig and Gratsel 1995, Zhou et al. 2002). When testing serum samples for viral presence with the application of specific antibodies absorbed on the surface of the crystal, screening was carried out to determine the content of viral particles; the results were correlated with those of the enzyme-linked immunosorbent assay.

In order to determine human cytomegalovirus the competitive immunoassay (Susmel et al. 2001) is recommended, as direct cooptation of the virus from the solution gives poor results (Konig and Gratsel 1995), while the competitive analysis, performed with a monolayer on poly-L-lysine (covalently bonded to the monolayer of tiosalicylic acid) allows the detection of the antigen in the range of 2.5 to 5 mg ml^{-1} , the detection limit being 1 mg ml^{-1} .

Antibodies and bacteriotoxins. Antibodies of various specificity, and some protein toxins can act as biomarkers of infectious and somatic diseases. The first researches on determining antibodies to human immunodeficiency virus (Kosslinger et al. 1995, Kosslinger et al. 1998) were reported in 1992. Their authors used synthetic peptides of human immunodeficiency virus (HIV) as receptor molecules immobilized on the surface of the electrode of a high-frequency resonator (20 MHz). The influence of the dilution of a serum sample on the reliability of the determination is shown.

The sandwich-analysis with the recombinant protein as receptor molecules and the amplification of the signal by secondary antibodies labelled with an enzyme was used to assess patients' contamination by the *Helicobacter pylori* bacteria, detectable by the presence of specific antibodies in serum (Su and Li 2001). The sensor can be used both in static and flow modes.

Determining specific antibodies in infectious yersiniosis (caused by the *Yersinia enterocolitica* bacteria) allows differentiating an acute intestinal infection from surgical pathology (e.g. acute appendicitis), which provides the correct choice of therapeutic measures and the identification of chronic forms of the disease. A sensor is proposed with the receptor layer on the basis of lipopolysaccharides (LPS) – components of the outer membrane of the cell wall of Gram-negative bacteria, consisting of covalently linked (Kalmykova et al. 2006 and

2007) carbohydrate and lipid parts. In determining specific antibodies it is necessary to provide spatial availability for carbohydrate, and not lipid, LPS (O-specific polysaccharides) macromolecules. Activation of silver electrodes is carried out with lipids of oil, Fig. 11.

The application of a hydrophobic electrode modifier for the immobilization of lipopolysaccharides leads to the interaction of the lipid part of macromolecules with a lipid coating and the orientation of O-specific polysaccharide chains (O-antigenic determinants) in the direction of the hydrophilic eluent (Fig. 11). At the same time the bilayer is characterized by maximum binding activity with corresponding antibodies.

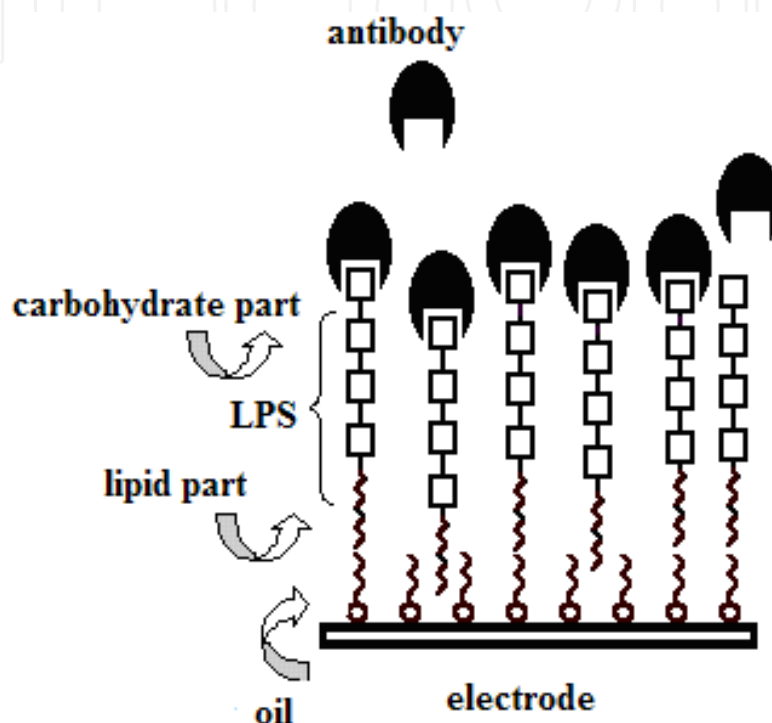

Fig. 11. The interaction of LPS with antibodies immobilized on a hydrophobic substrate (oil) (Kalmykova et al. 2007)

The significance of this research lies in both determining antibodies and establishing a correlation between different ways to express the activity of sera (activity titre and the concentration of specific antibodies). The sensor allows the determination of antibodies in serum with a higher sensitivity compared with the reaction of passive hemagglutination. This is useful for identifying yersiniosis at an earlier stage and monitoring treatment efficiency.

Another area in the application of sensors is the detection of parasites *Shistosoma japonicum* (Wu et al. 2003, Wu et al. 2006, Cheng et al. 2008) when specific antibodies are determined in blood as a result of polymer agglutination.

Of special interest are sensors for the determination of certain classes of antibodies – IgA, IgG, IgM, which can serve as indirect indicators of candidiasis and facilitate the diagnostics of fungal infections.

Determination of antibodies to DNA. One of the clinical forms of yersiniosis is the arthritic one, when patients with rheumatoid arthritis have antibodies to the *Y. enterocolitica* bacteria, serotype O:5. However, more often the arthritic pathology is an indicator of developing

autoimmune diseases: systemic lupus erythematosus, rheumatoid arthritis, chronic glomerulonephritis, etc. when antibodies to DNA are formed in the body itself. Immunosensors have been designed based on denatured DNA molecules for determining antibodies to DNA in blood serum (Fakhrullin et al. 2007, Kalmykova et al. 2003) in the range of 0.1 - 25 $\mu\text{g ml}^{-1}$ (0.03 - 8 IU), the detection limit being 0.01 $\mu\text{g ml}^{-1}$ (0.003 IU). Other substances of protein nature in blood plasma does not interfere with the quantitative determination of antibodies to DNA.

4. Conclusion

Possible practical applications of piezoelectric immunosensors are not limited to the examples discussed above. The analysis of papers published over the past 15 years shows that the new research direction, connected with the development and application of piezoelectric immunosensors, causes a growing concern around the world. Sensors are used in clinical diagnostics to identify high and low molecular compounds, to monitor the effectiveness of drugs action and their metabolism, to identify the causes of the intoxication of the body, to detect drug and doping agents in biological fluids.

The relatively low cost combined with high sensitivity and selectivity, plus the possibility to analyze just one drop of blood, saliva, or urine with little or no additional sample preparation, the resumption of the activity of the bioreceptor layer and multiple use make piezoelectric immunosensors a real alternative to the existing methods used in medicine.

Besides, the combination of piezoelectric micro- and nano-weighing with other methods (e.g. optical or electrochemical methods, the surface plasmon resonance method, the method of atomic force microscopy) will contribute to a better understanding of biochemical processes at the cellular level, leading to various diseases.

5. References

- Adanyi N., Varadi M., Kim N, Szendro I. (2006). Development of new immunosensors for determination of contaminants in food. *Current Appl. Phys.* 6. 279-286.
- Aizawa H., Kurasawa S., Ogawa K., Yoshimoto M., Miyake J., Tanaka H. (2001). Conventional diagnosis of C-reactive protein in serum using latex piezoelectric immunoassay. *Sens. Actuators B.* 76. 173-176.
- Aizawa H., Kurosawa S., Tanaka M., Wakida S., Talib Z.A., Park J. W., Yoshimoto M., Muratsugu M., Hilborn J., Miyake J., Tanaka H. (2001). Rapid diagnosis of *Treponema pallidum* in serum using latex piezoelectric immunoassay. *Analytica Chimica Acta.* 437(2). 167-169.
- Babacan S., Privarnik P., Letcher S., Rand A.G. (2000). Evaluation of antibody immobilization methods for piezoelectric biosensor application. *Biosens. Bioelectron.* 15. 615 -622.
- Bohunicky B., Mousa S. (2011). Biosensors: the new wave in cancer diagnosis. *Nanotechnology, Science and Applications.* 4. 1-10.
- Boujday S., Briandet R., Salmain M., Herry J.M., Marnet P.G., Gautier M., Pradier C.M. (2008). Detection of pathogenic *Staphylococcus aureus* bacteria by gold based immunosensors. *Microchim. Acta.* 163 (3-4). 203-209.
- Bovenizer J.S., Jacobs M.B., O'Sullivan C.K., Guilbault G.G. (1998), The Detection of *Pseudomonas aeruginosa* Using the Quartz Crystal Microbalance. *Anal. Lett.* 31. 1287-1295.

- Carter R.M., Mekalanos J.J., Lubrano G.J., Guilbault G.G. (1995). Quartz crystal microbalance detection of *Vibrio cholerae* O139 serotype. *J. Immunol. Methods*. 187. 121- 125.
- Casey P. (2004). Markers of myocardial injury and dysfunction. *AACN Clin. Issues*. 15. 547-557.
- Chang C.-C., Shenhsiung L., Yu C.-S., Chii-Wann L. (2011). Using Polyethylene Glycol-Modified Chitosan for Improvement of Carbohydrate Antigen 15-3 Detection on a Quartz Crystal Microbalance Biosensor. *Sensor Letters*. 9(1). 404-408.
- Chen Z.-G., Tang D.-Y. (2007) . Antigen-antibody interaction from quartz crystal microbalance immunosensors based on magnetic CoFe₂O₄/SiO₂ composite nanoparticle-functionalized biomimetic interface. *Bioprocess Biosyst Eng*. 30. 243-249.
- Cheng Ch.-W. , Chen Ch.-K. , Chen Y.-Sh., Chen L.-Y. (2008). Determination of *Schistosoma japonicum* circulating antigens in dilution serum by piezoelectric immunosensor and S/N enhancement. *Biosens.Bioelectron*.24(1).136-140.
- Cheng T., Lin T.-M., Chang H.-C. (2002). Physical adsorption of protamine for heparin assay using a quartz crystal microbalance and electrochemical impedance spectroscopy. *Anal. Chim. Acta*. 462 (2). 261-273.
- Chou S.-F., Hsu W.-L., Wang J.-M., Chen C.-Y. (2002). Determination of [alpha]-fetoprotein in human serum by a quartz crystal microbalance-based immunosensor. *Clin. Chemistr*. 48. 913 - 918.
- Chou S.-F., Hsu W.-L., Hwang J.-M., Chen C.-Y. (2002). Development of an immunosensor for human ferritin, a nonspecific tumor marker, based on a quartz crystal microbalance *Anal. Chimi. Acta*. 453. 181-189.
- Chu X., Zhao Z.L., Shen G.L., Yu R.Q. (2006). Quartz crystal microbalance immunoassay with dendritic amplification using colloidal gold immunocomplex. *Sensors and Actuators. B*. 114. 696-704.
- Corso C.D., Stubbs D.D., Lee S.-H., Goggins M., Hruban R.H., Hunt W.D. (2006). Real-time detection of mesothelin in pancreatic cancer cell line supernatant using an acoustic wave immunosensor. *Cancer Detection and Prevention*. 30 (2). 180-187.
- Ding Y, Liu J.,Jin X.,Lu H, Shen G., Yu R. (2008). Poly-L-lysine/hydroxyapatite/carbon nanotube hybrid nanocomposite applied for piezoelectric immunoassay of carbohydrate antigen 19-9. *Analyst*. 133. 184-190.
- Ding Y, Liu J, Wang H., Shen G., Yu R. (2007). A piezoelectric immunosensor for the detection of α -fetoprotein using an interface of gold/hydroxyapatite hybrid nanomaterial. *Biomaterials*. 28. 2147-2154.
- Ding Y., Liu J., Jin X., Shen G., Yu R. (2008). A Novel Piezoelectric Immunosensor for CA125 Using a Hydroxyapatite/Chitosan Nanocomposite-Based Biomolecular Immobilization Method. *Australian J. Chem*. 61(7). 500-505.
- Ermolaeva T. N, Kalmykova E. N, Shashkanova O. Yu. (2008). Piezoquartz Biosensors for the Analysis of Environmental Objects, Foodstuff and for Clinical Diagnostic. *Rus. J. General Chem*. 78 (12). 2430-2444.
- Ermolaeva T.N, Kalmykova E.N. (2006). Piezoelectric immunosensors: analytical potentials and outlooks. *Rus. Chem. Rev*. 75 (5). 397-409.
- Fung Y. S. and Wong Y. Y. (2001). Self-Assembled Monolayers as the Coating in a Quartz Piezoelectric Crystal Immunosensor To Detect Salmonella in Aqueous Solution. *Anal. Chem*. 73 (21). 5302-5309.
- Georganopoulou D.G., Carley R., Jones D.A., Boutelle M.G.. (2000). Development and comparison of biosensors for in-vivo applications. *Faraday Discuss*. 116. 291-303.

- Godber B., Frogley M., Rehak M., Sleptsov A., Thompson K.S.J., Uludag Y., and Cooper M.A (2007). Profiling of molecular interactions in real time using acoustic detection. *Biosens. Bioelectron.* 22 (9-10), 2382-2386.
- Godber B., Thompson K.S.J., Rehak M., Uludag Y., Kelling S., Sleptsov A., Frogley M, Wiehler K., Whalen Ch., Cooper M.A. (2005). Direct Quantification of Analyte Concentration by Resonant Acoustic Profiling. *Clin. Chem.* 10. 1962-1972.
- Grieshaber D., de Lange V., Hirt T., Lu Z., Voros J. (2008). Vesicles for Signal Amplification in a Biosensor for the Detection of Low Antigen Concentrations. *Sensors.* 8. 7894-7903.
- Guillo Ch., Roper M.G. (2008). Affinity assays for detection of cellular communication and biomarkers. *Analyst.* 133. 1481-1485.
- Han J., Zhang J., Xia Y., Li S., Long J. (2011). An immunoassay in which magnetic beads act both as collectors and sensitive amplifiers for detecting antigens in a microfluidic chip (MFC)-quartz crystal microbalance (QCM) system *Colloids and Surfaces A.* 31 (28). 1-9.
- Harteveld J.L.N., Nieuwenhuizen M.S., Wils E.R.J. (1997). Detection of staphylococcal enterotoxin B employing a piezoelectric crystal immunosensor. *Biosens. Bioelectron.* 12 (7). 661-667.
- He F.J., Zhang L.D, Zhao J.W, Hu B.L, Lei J.T. (2002). A TSM immunosensor for detection of M-tuberculosis with a new membrane material. *Sens. Actuators B.* 85 (3). 284-290.
- Jiang X, Wang R, Wang Y, Su X, Ying Y, Wang J, Li Y.(2011). Evaluation of different micro/nanobeads used as amplifiers in QCM immunosensor for more sensitive detection of E. coli O157:H7. *Biosens Bioelectron.*
- Justino C., Rocha- Santos T., Armando C., Rocha-Santos T. A. (2010). Review of analytical figures of merit of sensors and biosensors in clinical applications. *Trends Anal. Chem.* 29(10). 1172-1183.
- Kalmykova E. N., Dergunova E. S., Ermolaeva T. N., Gorshkova R. P., Komandrova N. A. (2007). Piezoquartz immunosensors for assessing the interactions between *Yersinia enterocolitica* lipopolysaccharides and antibodies to them. *Applied Biochemistry and Microbiology.* 44 (4).372-377.
- Kalmykova E. N., Dergunova E. S., Zubova N. Yu., Gorshkova, R. P., Komandrova N. A., Ermolaeva, T. N. (2007). Determination of antibodies to *Yersinia enterocolitica* bacteria using a piezoelectric quartz crystal immunosensor. *J. Anal. Chem.* 62 (10). 970-976.
- Kalmykova E.N., Dergunova E.S., Ermolaeva T.N., Gorshkova R.P., Komandrova N.A. (2006). Piezoelectric immunosensors on the basis of immobilized lipopolysaccharides for the determining of antibodies to the *Yersinia enterocolitica* bacteria. *Сорбционные и хроматографические процессы.* 6. 415-421.
- Kalmykova E.N., Garbusova A.V., Shashkanova O.YU., Zubova N.YU., Ermolaeva T.N. (2007). Flow-injection piezoelectric immunosensors for the phage detection. *Вестник ВГУ. Серия Химия. Биология. Фармация.* 6. 47-56.
- Kalmykova E.N., Garbusova A.V., Shashkanova O.YU., Zubova N.YU., Ermolaeva T.N.(2007). Quartz cristal microbalance immunosensors on the base antibodies immobilized for detection of *Yersinia Enterocolitica* bacteria in water media. *Известия вузов. Химия и химическая технология.* 50. 10-15.
- Kalmykova, E.N., Ermolaeva, T.N., Eremin, S.A. (2002.) The development of piezoelectric immunosensors for the flow-injection analysis of high- and low-molecular compounds. *Вестник МГУ. Серия Химия.* 43. 399-403.
- Keusgen M. (2002). Biosensors: new approaches in drug discovery. *Naturwissenschaften.* 89. 433-444.

- Kim G.-Ho, A. Garth Rand and Stephen V. Letcher (2003). Impedance characterization of a piezoelectric immunosensor part II: Salmonella typhimurium detection using magnetic enhancement. *Biosens. Bioelectron.* 18 (1). 91-99.
- Kim H., Bhunia A. K. (2008). SEL, a Multipathogen Selective Enrichment Broth for Simultaneous Growth of Salmonella enterica, Escherichia coli O157:H7, and Listeria monocytogenes. *Appl. Environ. Microbiol.* 74 (15). 4853-4866.
- Kim N, Park I.S, Kim D.K. (2004). Characteristics of a label-free piezoelectric immunosensor detecting Pseudomonas aeruginosa. *Sens. Actuators B.* 100 (3). 432-438.
- Kim N. H., Bark T. J., Park H. G., Seong G. H. (2007). Highly Sensitive Biomolecule Detection on a Quartz Crystal Microbalance Using Gold Nanoparticles as Signal Amplification Probes. *Anal. Sci.* 23. 177-181.
- Kim N., Kim D.-K., Cho Y.-J. (2009). Development of indirect-competitive quartz crystal microbalance immunosensor for C-reactive protein. *Sens. Actuators B.* 143(1). 444-448.
- Kim N., Kim D.-K., Cho Y.-J. (2010). Gold nanoparticle-based signal augmentation of quartz crystal microbalance immunosensor measuring C-reactive protein. *Current Appl Phys.* 10(4). 1227-1230
- Konig B. and Gratzel M. (1993). Development of a piezoelectric immunosensor for the detection of human erythrocytes. *Anal. Chim. Acta.* 276. 329-333.
- Kosslinger C., Drost S., Abel F., Wolf H., Koch S., Woias P. (1998). The Quartz Crystal Microbalance (QCM) as an Immunosensor. *Methods in Molecular Medicine.* 13. II. Part 8. 519-529.
- Kößlinger C., Uttenthaler E., Drost S., Aberl F, Wolf H., Brin G., Stanglmaier A, Sackmann E. (1995). Comparison of the QCM and the SPR method for surface studies and immunological applications. *Sens. Actuators B.* 24(1-3). 107-112.
- Kubitschko S., Spinke I., Brucker T., Pol S., Oranth N. (1997). Sensitivity Enhancement of Optical Immunosensors with Nanoparticles. *Anal. Biochem.* 253. 112-122.
- Kurosawa S, Aizawa H, Tozuka M, Nakamura M, Park JW. (2003). Immunosensors using a quartz crystal microbalance. *Meas Sci. Technol.* 14 (11). 1882-1887.
- Kurosawa S., Hirokawa T., Kashima K., Aizawa H., Park J.-W., Tozuka M., Yoshimi Y., Hirano K. (2002). Adsorption of anti-C-Reactive Protein Monoclonal Antibody and Its F(ab')₂ fragment on Plasma-Polymerized Styrene, Allylamine and Acrylic Acid Coated with Quartz Crystal Microbalance. *J. Photopolym. Sci. Technol.* 15. 323 -331.
- Kurosawa S., Nakamura M., Park J.W., Aizawa H., Yamada K., Hirata M. (2004). Evaluation of a high-affinity QCM immunosensor using antibody fragmentation and 2-methacryloyloxyethyl phosphorylcholine (MPC) polymer. *Biosens. Bioelectron.* 2. 1134-1139.
- Le D., He F.-J., Jiang T.J., Nie L., Yao Sh., (1995). A goat-anti-human IgG modified piezoimmunosensor for Staphylococcus aureus detection, *J. Microbiol Meth.* 23 (2). 229-234.
- Lee Y., Lee E.K., Cho Y.W., Matsui T., Kan g I. C., Kim T.S., Han M. H. (2003) . ProteoChip: A highly sensitive protein microarray prepared by a novel method of protein immobilization for application of protein-protein interaction studies. *Proteomics.* 3. 2289-2304.
- Li D, Feng Y, Zhou L, Ye Z, Wang J, Ying Y, Ruan Ch, Wang R, Li Y. (2011). Label-free capacitive immunosensor based on quartz crystal Au electrode for rapid and sensitive detection of Escherichia coli O157:H7. *Anal Chim Acta.* 68 (1). 89-96.
- Liu F., Su X.-L, Li Y. (2007). QCM immunosensor with nanoparticle amplification for detection of Escherichia coli O157:H7. *Sensing and Instrumentation for Food Quality and Safety.* 1. 161-168.

- Malhotra B.D., Chaubey A. (2003) Biosensors for clinical diagnostics industry. *Sens. Actuators B*. 91. 117-127.
- Mao Ch., Liu A. (2009). Virus-Based Chemical and Biological Sensing. *Angew. Chem.* 48(37). 6790-6810.
- Martínez-Rivas A., Chinestra P., Favre G., Pinaud S., Séverac Ch., Faye J.-Ch., Vieu Ch. (2010). Detection of label-free cancer biomarkers using nickel nanoislands and quartz crystal microbalance. *Int. J Nanomedicine*. 5. 661-668.
- Mascin M., Tombelli S. (2008). Biosensors for biomarkers in medical diagnostics. *TOC*. 13 (7-8). 637-657.
- McBride J.D., Cooper M.A. (2008). A high sensitivity assay for the inflammatory marker C-reactive protein employing acoustic biosensing, *J. Nanobiotechnol.* 6. 5.
- Minunni M., Mascini M., Carter R.M., Jacobs M.B., Lubrano G.J., Guilbault G.G. (1996). A quartz crystal microbalance displacement assay for *Listeria monocytogenes*. *Anal. Chim. Acta*. 325. 169-174.
- Mohammed M.-I. and Desmulliez M. P. Y. (2011). Lab-on-a-chip based immunosensor principles and technologies for the detection of cardiac biomarkers: a review. *Lab Chip*. 11. 569-595.
- Muratsugu M, Ohta F., Miya Y., Hosokawa T, Kurosawa S., Kamo N., Ikeda H. (1993). Quartz crystal microbalance for the detection of microgram quantities of human serum albumin: relationship between the frequency change and the mass of protein adsorbed. *Anal. Chem.* 65 (20). 2933-2937.
- Nakayama T., Watanabe M., Teramoto T., Kitajima M. (1997). Slope analysis of CA19-9 and CEA for predicting recurrence in colorectal cancer patients. *Anticancer Res.* 17. 1379-1382.
- P. Skladal, C.S. Riccardi, H. Yamanaka, P.L. Costa. (2004). Piezoelectric biosensors for real-time monitoring of hybridization and detection of the hepatitis C virus. *J. Virol. Meth.* 117. 145-151.
- Park I.S., Kim N. (1998). Thiolated Salmonella antibody immobilization onto the gold surface of piezoelectric quartz crystal. *Biosens. Bioelectron.* 13 (10). 1091 - 1097.
- Pathirana S.T., Barbaree J., Chin B.A., Hartell M.G., Neely W.C, Vodyanoy V. (2000). Rapid and sensitive biosensor for Salmonella. *Biosens. Bioelectron.* 15. 135-141.
- Plomer M., Guilbault G.G., Hock B. (1992). Development of piezoelectric immunosensor for the detection of Enterobacteria. *Enzyme. Microb. Technol.* 14. 230 - 238.
- Pohanka M., Pavlis O., Skladal P. (2007). Diagnosis of tularemia using piezoelectric biosensor technology. *Talanta*. 71. 981-985.
- Pohanka M., Treml F., Hubál M., Bandouchová H., Beklová M., Pikula J. (2007). Piezoelectric Biosensor for a Simple Serological Diagnosis of Tularemia in Infected European Brown Hares (*Lepus europaeus*). *Sensors*. 7. 2825-2834 .
- Prusak-Sochaczewski E., Luong J. (1990). Detection of Human Transferrin by the piezoelectric Crystal. *Anal. Lett.* 23. 183-194.
- Reyes P.I., Zhang Z., Chen H., Duan Z., Zhong J., Saraf G., Taratula O., Galoppini E., Boustany N. (2009). A ZnO Nanostructure-Based Quartz Crystal Microbalance Device for Biochemical Sensing. *IEEE SENSORS JOURNAL*. 9 (10). 1302-1307.
- Saber R., Mutlu S., Piskin E. (2002). Glow-discharge treated piezoelectric quartz crystals as immunosensors for HSA detection. *Biosens. Bioelectron.* 17. 727-734.
- Sakai G., Saiki T., Uda T., Miura N., Yamazoe N. (1995). Selective and repeatable detection of human serum albumin by using piezoelectric immunosensor. *Sensor Actuator B*. 24 (25). 134-137.

- Sakti S.P., Hauptmann P., Zimmermann B, Buhling F., Ansorge S. (2001). Disposable HSA QCM-immunosensor for practical measurement in liquid. *Sens. Actuators B*. 78. 257-262.
- Salmain M, Ghasemi M, Boujday S, Spadavecchia J, Técher C, Val F, Le Moigne V, Gautier M, Briandet R, Pradier CM. (2011). Piezoelectric immunosensor for direct and rapid detection of staphylococcal enterotoxin A (SEA) at the ng level. *Biosens Bioelectron*. 26.
- Sauerbrey G. (1959). Use of quartz vibrator for weighing thin films on microbalance. *Z. Phys*. 155. 206-210.
- Shen Z., Wang J., Qiu Z., Jin M, Wang X., Chen Z., Li J., Cao F. (2011). QCM immunosensor detection of *Escherichia coli* O157:H7 based on beacon immunomagnetic nanoparticles and catalytic growth of colloidal gold. *Biosens Bioelectron*. 29 (7). 3376-3381.
- Simon E. (2010). Biological and chemical sensors for cancer diagnosis. *Meas. Sci. Technol*. 21. 1-15.
- Skladal P. (2003). Piezoelectric Quartz Crystal Sensors Applied for Bioanalytical Assays and Characterization of Affinity Interactions. *J. Braz. Chem*. 14. 491-499.
- Su X, Low S, Kwang J, Chew V, Li S. (2001). Piezoelectric quartz crystal based veterinary diagnosis for *Salmonella enteritidis* infection in chicken and egg. *Sens. Actuators B*. 75(1-2). 29-35.
- Su X., Li S. (2001). Serological determination of *Helicobacter pylori* infection using sandwiched and enzymatically amplified piezoelectric biosensor *Anal. Chim. Acta*. 429 (1). 27-36.
- Su X., Li Y. (2004). A self-assembled monolayer-based piezoelectric immunosensor for rapid detection of *Escherichia coli* O157: H7. *Biosens. Bioelectron*. 19 (6). 563-574.
- Su X., Li Y. (2005). A QCM immunosensor for *Salmonella* detection with simultaneous measurements of resonant frequency and motional resistance. *Biosens Bioelectron*. 21 (6). 840-848.
- Su X.D., Chew F.T., Li S.F.Y. (2000). Design and Application of Piezoelectric Quartz Crystal-based Immunoassay. *Anal. Sci*. 16. 107-114.
- Su X.D., Chew F.T., Li S.F.Y. (2000). Piezoelectric quartz crystal based label-free analysis for allergy disease. *Biosens. Bioelectron*. 15. 629-639.
- Susmel S., O'Sullivan C.K., Guilbault G.G. (2000). Human cytomegalovirus detection by a quartz crystal microbalance immunosensor. *Enzyme Technol*. 27. 639-645.
- Tanaka N., Okada S., Ueno H., Okusaka T., Ikeda M. (2000). The usefulness of serial changes in serum CA19-9 levels in the diagnosis of pancreatic cancer. *Pancreas*. 20. 378-381.
- Tang D.-Q., Zhang D.-J., Tang D.-Y., Ai H. (2006). Amplification of the antigen-antibody interaction from quartz crystal microbalance immunosensors via back-filling immobilization of nanogold on biorecognition surface. *J. Immunol. Meth*. 316 144 -152.
- Tang. D., Yuan R., Chai Y. (2008). Quartz crystal microbalance immunoassay for carcinoma antigen 125 based on gold nanowire-functionalized biomimetic interface. *Analys*. 133. 933-938.
- Tatsuta M., Yamamura H., Iishi H., Kasugai H, Okuda S. (1986). Value of Serum Alpha-Fetoprotein and Ferritin in the Diagnosis of Hepatocellular Oncology. 43. 306- 310.
- U. S. Patent 4,242,096. Immunoassays for Antigens. Oliveira, R.J. and S.F. Silver, December 30, 1980.
- U.S. Patent, 4,314,821. Sandwich Immunoassay Using Piezoelectric Oscillator. T.K. Rice, February 9, 1982.
- Uenishi T., Kubo S., Hirohashi K., Tanaka H., Shuto T, Yamamoto T., Nishiguch S. (2003). Cytokeratin-19 fragments in serum (CYFRA 21-1) as a marker in primary liver cancer. *S. Br. J. Cance*. 88(12). 1894 -1899.

- Uludağ Y, Tothill IE. (2010). Development of a sensitive detection method of cancer biomarkers in human serum (75%) using a quartz crystal microbalance sensor and nanoparticles amplification system. *Talanta*. 82 (1). 277-282.
- Vaughan R.D, Guilbault G.G. (2007). Piezoelectric Immunosensors. In: Steinem C, Janshoff A, eds. *Piezoelectric Sensors*. Vol. 5. Springer Berlin Heidelberg. 237-280.
- Vaughan R.D., O'Sullivan C.K., Guilbault G.G.. (2001). Development of a quartz crystal microbalance (QCM) immunosensor for the detection of *Listeria monocytogenes*. *Enzyme. Microb. Technol.* 29. 635-639.
- Wang H., Zeng H, Liu Z., Yang Y, Deng T., Shen G., Yu R. (2004). Immunophenotyping of acute leukemias using quartz crystal microbalance and monoclonal antibodies coated magnetic microspheres. *Anal Chem.* 76. 2571-2578.
- Wang L.J., Wu C.S., Hu Z.Y., Zhang Y.F., Li R, Wang P. (2008). Sensing *Escherichia coli* O157:H7 via frequency shift through a self-assembled monolayer based QCM immunosensor. *J. Zhejiang. Univ. Sci. B.* 9. 121- 131.
- Wang R., Dong W., Ruan Ch., Kanayeva D., Lassiter K., Tian R., Li Y. (2008). TiO₂ nanowire Jacobs bundle microelectrode based impedance immunosensor for rapid and sensitive detection of *Listeria monocytogenes*. *Nano Lett.* 9 (12). 4570 - 4583
- Wei Q., Li T., Wang G., Li H., Qian Z., Yang M. (2010). Fe₃O₄ nanoparticles-loaded PEG-PLA polymeric vesicles as labels for ultrasensitive immunosensors. *Biomaterials.* 31. 7332-7339.
- Wong Y.Y., Ng S.P., Ng M.H., Si S.H., Yao S.Z., Fung Y.S. (2002). Immunosensor for the differentiation and detection of *Salmonella* species based on a quartz crystal microbalance. *Biosens. Bioelectron.* 17 (8). 676 -684.
- Wong-ek K., Chailapakul O., Nuntawong N., Jaruwongrungrongsee K., Tuantranont A. (2010). Cardiac troponin T detection using polymers coated quartz crystal microbalance as a cost-effective immunosensor. *Biomed Tech (Berl).* 55 (5). 279-84.
- Wu J., Zhifeng F., Yan F., Ju H. (2007). Biomedical and clinical applications of immunoassays and immunosensors for tumor markers. *Trends Anal. Chem.* 26 (7). 679-688.
- Wu Z.-Y., Jian W., Wang S.-P., Yu R.-Q. (2006). An amplified mass piezoelectric immunosensor for *Schistosoma japonicum*. *Biosens. Bioelectron.* 22 (2). 207-212.
- Wu Z.-Y., Shen G.-L., Wang S.-P., Yu R.-Q. (2003). Quartz-crystal microbalance immunosensor for *Schistosoma japonicum*-infected rabbit serum. *Anal. Sci.* 19. 437-440.
- Xia C., Guoli S., Feiye X., Rugin Y. (1997). Polymer Agglutination-Based Piezoelectric Immunoassay for the Determination of Human Serum Albumin. *Anal. Lett.* 30. 1783-1796.
- Yang G.-J., Huang J.-L., Meng W.-J., Ming S., Jiao X.-A. (2009). A reusable capacitive immunosensor for detection of *Salmonella* spp. based on grafted ethylene diamine and self-assembled gold nanoparticle monolayers. *Anal. Chimica Acta.* 647 (2). 159-166.
- Ying-Sing F., Shi-Hui S., De-Rong Z. (2000). Piezoelectric crystal for sensing bacteria by immobilizing antibodies on divinylsulphone activated poly-m-aminophenol film. *Talanta.* 51 (1). 151-158.
- Zeng H., Wang H., Chen F., Xin H, Wang G., Xiao L., Song K., Wu D., He Q., Shen G. (2006). Development of quartz-crystal-microbalance-based immunosensor array for clinical immunophenotyping of acute leukemias. *Anal. Biochem.* 351. 69-76.
- Zhang B., Zhang X., Yan H.H., Xu S.J., Tang D.H., Fu W.L. (2007). A novel multi-array immunoassay device for tumor markers based on insert-plug model of piezoelectric immunosensor. *Biosens Bioelectron.* 23 (1). 19-25.
- Zhou X.D., Liu L.J., Hu M., Wang L.L., Hu J.M. (2002). Detection of hepatitis B virus by piezoelectric biosensor. *J. Pharm. Biomed. Anal.* 27. 341-345.

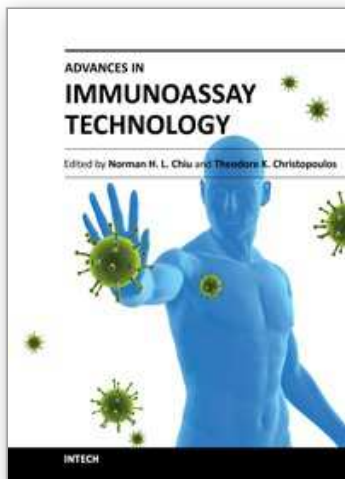

Advances in Immunoassay Technology

Edited by Dr. Norman H. L. Chiu

ISBN 978-953-51-0440-7

Hard cover, 180 pages

Publisher InTech

Published online 23, March, 2012

Published in print edition March, 2012

From the basic in vitro study of a specific biomolecule to the diagnosis or prognosis of a specific disease, one of the most widely used technology is immunoassays. By using a specific antibody to recognize the biomolecule of interest, relatively high specificity can be achieved by immunoassays, such that complex biofluids (e.g. serum, urine, etc.) can be analyzed directly. In addition to the binding specificity, the other key features of immunoassays include relatively high sensitivity for the detection of antibody-antigen complexes, and a wide dynamic range for quantitation. Over the past decade, the development and applications of immunoassays have continued to grow exponentially. This book focuses on some of the latest technologies for the development of new immunoassays.

How to reference

In order to correctly reference this scholarly work, feel free to copy and paste the following:

Tatyana Ermolaeva and Elena Kalmykova (2012). Capabilities of Piezoelectric Immunosensors for Detecting Infections and for Early Clinical Diagnostics, *Advances in Immunoassay Technology*, Dr. Norman H. L. Chiu (Ed.), ISBN: 978-953-51-0440-7, InTech, Available from: <http://www.intechopen.com/books/advances-in-immunoassay-technology/capabilities-of-piezoelectric-immunosensors-for-detecting-infections-and-for-early-clinical-diagnost>

INTECH
open science | open minds

InTech Europe

University Campus STeP Ri
Slavka Krautzeka 83/A
51000 Rijeka, Croatia
Phone: +385 (51) 770 447
Fax: +385 (51) 686 166
www.intechopen.com

InTech China

Unit 405, Office Block, Hotel Equatorial Shanghai
No.65, Yan An Road (West), Shanghai, 200040, China
中国上海市延安西路65号上海国际贵都大饭店办公楼405单元
Phone: +86-21-62489820
Fax: +86-21-62489821

© 2012 The Author(s). Licensee IntechOpen. This is an open access article distributed under the terms of the [Creative Commons Attribution 3.0 License](#), which permits unrestricted use, distribution, and reproduction in any medium, provided the original work is properly cited.

IntechOpen

IntechOpen