

We are IntechOpen, the world's leading publisher of Open Access books Built by scientists, for scientists

4,800

Open access books available

122,000

International authors and editors

135M

Downloads

Our authors are among the

154

Countries delivered to

TOP 1%

most cited scientists

12.2%

Contributors from top 500 universities



WEB OF SCIENCE™

Selection of our books indexed in the Book Citation Index
in Web of Science™ Core Collection (BKCI)

Interested in publishing with us?
Contact book.department@intechopen.com

Numbers displayed above are based on latest data collected.

For more information visit www.intechopen.com



Greenhouse Fuzzy and Neuro-Fuzzy Modeling Techniques

Gorrostieta-Hurtado Efren¹, Pedraza-Ortega Jesus Carlos¹,
Aceves-Fernández Marco Antonio, Ramos-Arreguín Juan Manuel¹,
Tovar-Arriaga Saúl¹ and Sotomayor-Olmedo Artemio²

¹Facultad de Informática, Universidad Autónoma de Querétaro,

²Facultad de Ingeniería, Universidad Autónoma de Querétaro,

Querétaro,

México

1. Introduction

During the last decades, a considerable effort was devoted to develop adequate greenhouse climate and crop models, for driving simulation, control and managing (Guzmán-Cruz, *et. Al*, Rico-Garcia, *et al*). The study and design of greenhouse environmental models implies having a clear understanding of the greenhouse climate processes. These models must be related with the external influences of the outside weather conditions (such as solar radiation, outside air temperature, wind velocity, etc.), and with the control actions performed (such as ventilation, cooling, heating, among others). The practical goal of this work is to model the greenhouse air temperature and humidity using clustering techniques and made an automatically generator of fuzzy rules relations from real data in order to predict the behavior inside the greenhouse.

The soft computing techniques, such as neural networks, clustering algorithms and fuzzy logic, have been successfully applied to classification and pattern recognition. Besides, fuzzy logic is highly used when the system modeling implies information is scarce, imprecise or when the system is described by complex mathematical model. An example of this kind of structure is a greenhouse and it's inherit variables such as: indoor and outdoor temperature and humidity, wind direction and speed, etc. These variables present a dynamic and non-linear behavior; being the in-house temperature and internal humidity the key variables for the greenhouse control and modeling. In this chapter, the construction of fuzzy systems by fuzzy c-means and fuzzy subtractive clustering are described. Finally a comparison with adaptive neuro-fuzzy inference system (anfis) and neural networks will be presented.

2. Greenhouse model

The non-linear behavior of the greenhouse-climate is a combination of complex physical interactions between energy transfer such as radiation and temperature and mass transfer like humidity and wind (indoor and outdoor the greenhouse).

In this work the humidity and temperature are considered as the greenhouse key parameters, based on (Guzmán-Cruz, *et. Al*, Rico-Garcia, *et al*) observations.

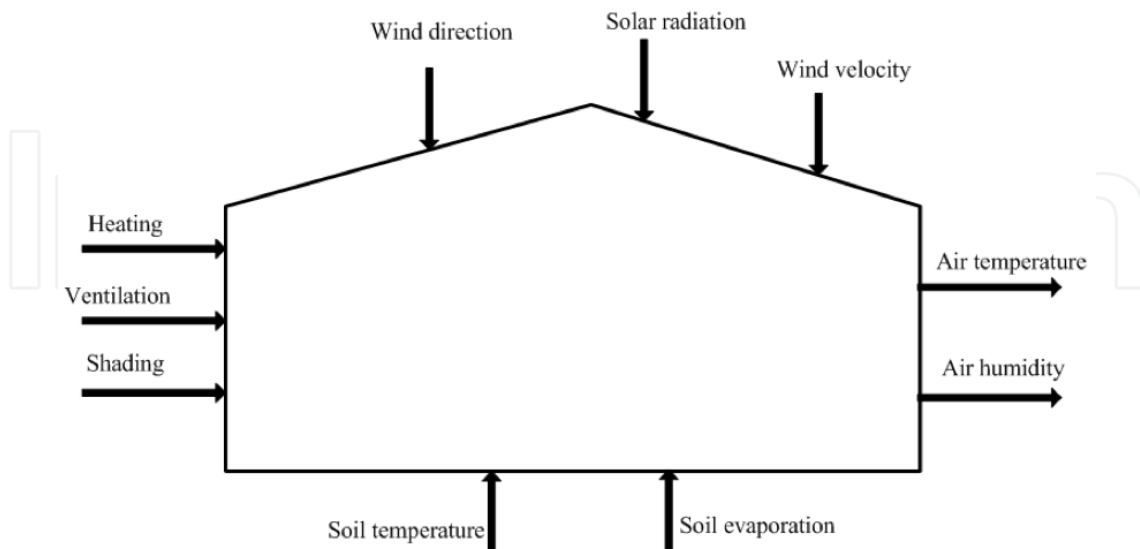

Fig. 1. Greenhouse variable scheme.

3. Fuzzy systems

Fuzzy inference systems (FIS) are also known as fuzzy rule-based systems. This is a major unit of a fuzzy logic system. The decision-making is an important part in the entire system. The FIS formulates suitable rules and based upon the rules the decision is made. This is mainly based on the concepts of the fuzzy set theory, fuzzy IF-THEN rules, and fuzzy reasoning. FIS uses "IF - THEN" statements, and the connectors present in the rule statement are "OR" or "AND" to make the necessary decision rules.

Fuzzy inference system consists of a fuzzification interface, a rule base, a database, a decision-making unit, and finally a defuzzification interface as described in Chang(et al 2006). A FIS with five functional block described in Fig.2.

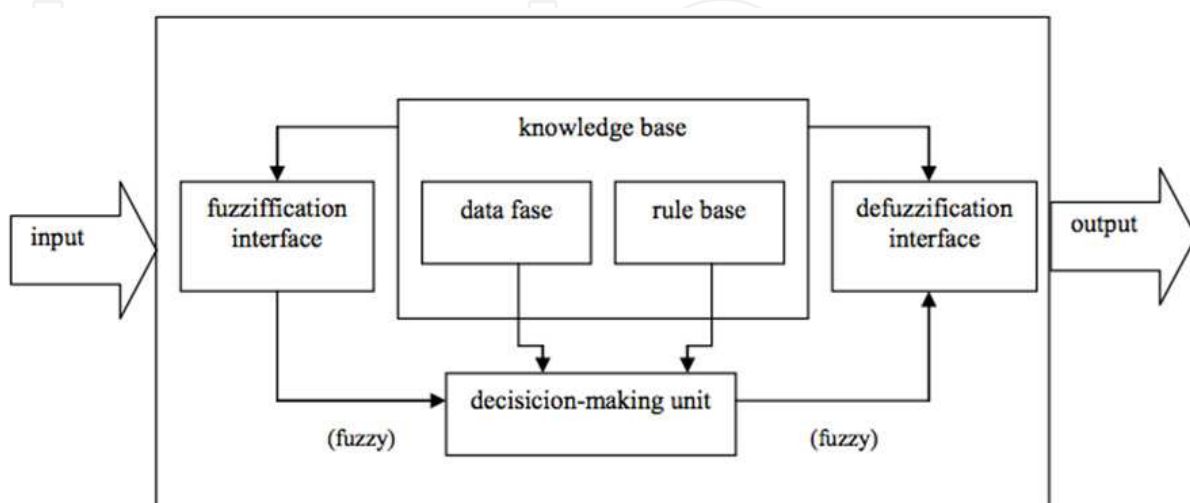

Fig. 2. Fuzzy Inference System Architecture

The function of each block is as follows:

- A rule base containing a set of fuzzy IF-THEN rules;
- A database which defines the membership functions of the fuzzy sets used in the fuzzy rules;
- A decision-making unit which performs the inference operations on the rules;
- A fuzzification interface which transforms the crisp inputs into degrees of match with linguistic values; and
- A defuzzification interface which transforms the fuzzy results of the inference into a crisp output.

The working of FIS is as follows. The inputs are converted in to fuzzy by using fuzzification method. After fuzzification the rule base is formed. The rule base and the database are jointly referred to as the knowledge base.

Defuzzification is used to convert fuzzy value to the real world value which is the output.

The steps of fuzzy reasoning (inference operations upon fuzzy IF-THEN rules) performed by FISs are:

- Compare the input variables with the membership functions on the antecedent part to obtain the membership values of each linguistic label. (this step is often called fuzzification.)
- Combine (through a specific t-norm operator, usually multiplication or min) the membership values on the premise part to get firing strength (weight) of each rule.
- Generate the qualified consequents (either fuzzy or crisp) or each rule depending on the firing strength.
- Aggregate the qualified consequents to produce a crisp output. (This step is called defuzzification.)

4. Fuzzy clustering techniques

There are a number of fuzzy clustering techniques available. In this work, two fuzzy clustering methods have been chosen: fuzzy c-means clustering and fuzzy clustering subtractive algorithms. These methods are proven to be the most reliable fuzzy clustering methods as well as better forecasters in terms of absolute error according to some authors [Sin, Gomez, Chiu].

Since 1985 when the fuzzy model methodology suggested by Takagi-Sugeno [Takagi *et al* 1985, Sugeno *et al* 1988], as well known as the TSK model, has been widely applied on theoretical analysis, control applications and fuzzy modeling.

Fuzzy system needs the precedent and consequence to express the logical connection between the input output datasets that are used as a basis to produce the desired system behavior [Sin *et al* 1993].

4.1 Fuzzy Clustering Means (FCM)

Fuzzy C-Means clustering (FCM) is an iterative optimization algorithm that minimizes the cost function given by:

$$J = \sum_{k=1}^n \sum_{i=1}^c \mu_{ik}^m \|x_k - v_i\|^2 \quad (3)$$

Where n is the number of data points, c is the number of clusters, x_k is the k th data point, v_i is the i th cluster center μ_{ik} is the degree of membership of the k th data in the i th cluster, and m is a constant greater than 1 (typically $m=2$) [Aceves *et al* 2011]. The degree of membership μ_{ik} is defined by:

$$\mu_{ik} = \frac{1}{\sum_{j=1}^c \left(\frac{\|x_k - v_i\|}{\|x_k - v_j\|} \right)^{2/(m-1)}} \quad (4)$$

Starting with a desired number of clusters c and an initial guess for each cluster center v_i , $i = 1, 2, 3, \dots, c$, FCM will converge to a solution for v_i that represents either a local minimum or a saddle point cost function [Bezdek *et al* 1985]. The FCM method utilizes fuzzy partitioning such that each point can belong to several clusters with membership values between 0 and 1. FCM include predefined parameters such as the weighting exponent m and the number of clusters c .

4.2 Fuzzy clustering subtractive

The subtractive clustering method assumes each data point is a potential cluster center and calculates a measure of the likelihood that each data point would define the cluster center, based on the density of surrounding data points. Consider m dimensions of n data point (x_1, x_2, \dots, x_n) and each data point is potential cluster center, the density function D_i of data point at x_i is given by:

$$D_i = \sum_{j=1}^n e^{-\left(\frac{\|x_i - x_j\|^2}{\left(\frac{r_a}{2}\right)^2} \right)} \quad (5)$$

where r_a is a positive number. The data point with the highest potential is surrounded by more data points. A radius defines a neighbour area, then the data points, which exceed r_a , have no influence on the density of data point.

After calculating the density function of each data point is possible to select the data point with the highest potential and find the first cluster center. Assuming that X_{c1} is selected and D_{c1} is its density, the density of each data point can be amended by:

$$D_i = D_i - D_{c1} e^{-\left(-\frac{\|x_i - x_{c1}\|^2}{\left(\frac{r_b}{2}\right)^2} \right)} \quad (6)$$

The density function of data point which is close to the first cluster center is reduced. Therefore, these data points cannot become the next cluster center. r_b defines an neighbour area where the density function of data point is reduced. Usually constant $r_b > r_a$. In order to avoid the overlapping of cluster centers near to other(s) is given by [Yager *et al* 1994]:

$$r_b = \eta \cdot r_a \quad (7)$$

4.3 Fuzzy model construction

When cluster estimation method is applied to a collection of input/output data, each cluster center illustrates a characteristic behavior of the system. Hence, each cluster center can be used as the basis of a rule that describes the system behavior. Consider a set of c cluster centers $\{x_1^*, x_2^*, x_3^*, \dots, x_c^*\}$ in an M -dimensional space. Let the first N dimensions correspond to the input variables and the last $M-N$ dimensional corresponds to output variables. Each vector x_i^* could be decomposed into two component vectors y_i^* and z_i^* where y_i^* contains the first N elements of x_i^* and z_i^* contains the last $M-N$ elements

Then consider each cluster center x_i^* is represents a fuzzy rule that describes the system behavior. Given an input vector y , the degree to which rule i is fulfilled is defined by:

$$\mu_i = e^{-\alpha \|y y_i^*\|^2} \quad (6)$$

where α is the constant defined by [15].

$$\alpha = \frac{4}{r_a^2} \quad (7)$$

The output vector z is computed by:

$$z = \frac{\sum_{i=1}^c \mu_i z_i^*}{\sum_{i=1}^c \mu_i} \quad (8)$$

then this computational model is in terms of a fuzzy inference system employing *if-then* rules following the form:

$$\text{IF } x_1 \text{ is } A_1 \text{ and } x_2 \text{ is } A_2 \text{ and } \dots \text{ THEN } Z_1 \text{ is } B_1 \text{ and } Z_2 \text{ is } B_2 \dots \quad (9)$$

where Y_1 is the j th input variable and Z_1 is the j th output variable. A_1 is an exponential membership function and B_1 is a singleton for the i th rule that is represented by cluster center x_i^* , A_j and B_j are given by:

$$A_j(Q) = e^{-\alpha (q - x_{ij}^*)^2} \quad (10)$$

$$B_j = Z_{ij}^* \quad (11)$$

where y_{ij}^* is the j th element of y_i^* and z_{ij}^* is the j th element of z_i^* . This computational scheme is equivalent to an inference method that uses multiplication as the *AND* operator, weights the output of each rule by the firing strength, and computes the output as a weighted average of the output of each rule [7] [10] [14][19].

Equation 12 represents a dynamic system where the function is expressed by the current input variables and the previous output.

$$y(k) = f(y(k-n), u(k)) \quad (12)$$

Where the state-transition function in this particular case is the ARX (Auto Regressive eXogenous) function (equation 12). The output variables are represented by $y(k)$ and the input variables by $u(k)$. the variable $e(k)$ represents white noise, whereas the system order is represented by the n variable.

$$y(k) = \sum_{j=1}^n a_j y(k-j) + \sum_{j=0}^n b_j u(k-j) + e(k) \quad (13)$$

The fuzzy system in this case is the proposed by Takagi-Sugeno [8] in which the following equation is presented:

$$\text{IF } x_1 \text{ is } A_1 \text{ and } x_2 \text{ is } A_2 \text{ and } \dots \text{ THEN } \zeta(x) \quad (14)$$

The function $\zeta(x)$ of the consequence corresponds to a part of a data-cluster as shown on equation 15

$$\zeta(x) = a^T x + b \quad (15)$$

5. Neural networks

Artificial neural networks (ANN's) can be used to solve complex problems where noise immunity is important. [12]. These feature is why we choose ANN's to model a dynamic system and create a fuzzy inference system. There are two ways to train an ANN: supervised training and un-supervised training. Supervised training requires training set where the input and the desired output of the network are provided for several training cases, whilst un-supervised training requires only the input of the network, and the ANN is supposed to classify (separate) the data appropriately [10]. In this paper we decide to use a supervised ANN because our data source become from experimental measurements.

6. The perceptron

The neuron or node or unit, as it is called, is a processing element that takes a number of inputs, weights them, sums them up, and uses the result as the argument for a singular valued function, the activation function. (Figure 3) [12], [13].

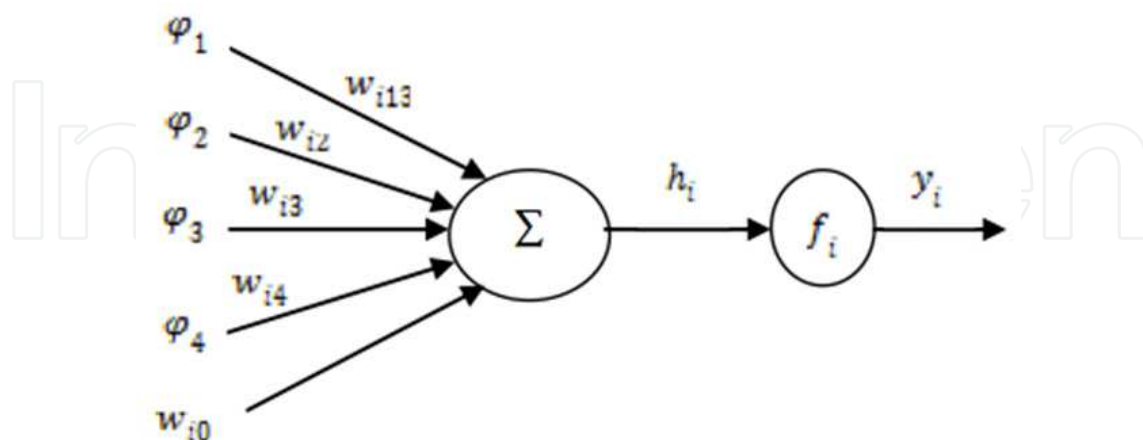

Fig. 3. Topology of perceptron.

To determine the weight value it is crucial to have a set of samples that correlates the output y_i with the inputs φ_i . The task of determining the weights from this example is called training or learning, and is basically a conventional estimation problem.[10]

7. The multilayer perceptron

Neurons can combine into a network in numerous fashions. Beyond any doubt the most common of these is the Multilayer Perceptron (MLP) network. The basic MLP-network is constructed by ordering the units in layers, letting each neuron in a layer take as an input only the outputs of neurons in the previous layer or external inputs. Due to the structure, this type of network is often referred to as a feedforward network. [10], [12], [13]. The MLP-network is straightforward to employ for discrete-time modelling of dynamic systems.[10]

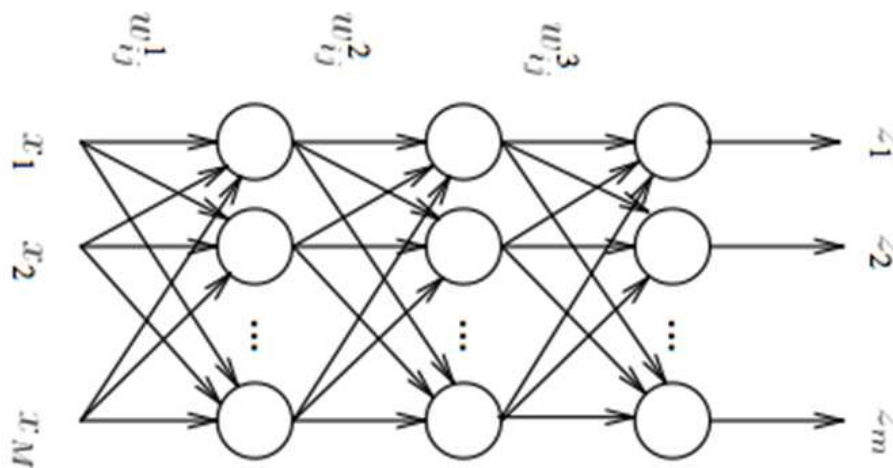

Fig. 4. Multilayer perceptron architecture.

8. The Adaptive Neuro-Fuzzy Inference System(ANFIS)

In a conventional fuzzy inference system, the number of rules is decided by an expert who is familiar with the system to be modelled. In this particular case study no expert was available and the number of membership functions assigned to each input is chosen empirically. This is carried out by examining the desired input-output data and/or by trial and error. This situation is much the same as ANN's. In this section ANFIS topology and the learning method used for this neuro-fuzzy network are presented. Both neural network and fuzzy logic are model-free estimators and share the common ability to deal with the uncertainties and noise. It is possible to convert fuzzy logic architecture to a neural network and vice versa.[15] This makes it possible to combine the advantages of neural network and fuzzy logic[7][8]. (see figure).

Layer 1: Every node in i in this layer is a square node with a node function

$$o_i^1 = \mu A_i(x) \quad (16)$$

Where x is the input node i , and A_i is the linguistic label (small, large, etc.) associated with this node function. In other words, o_i^1 is the membership function of and it specifies the degree to which the A_i given x satisfies the quantifier A_i . Usually we choose $\mu A_i(x)$ to be bell shaped with maximum equal to 1 and minimum equal to 0, such as

$$\mu A_i(x) = \frac{1}{1 + \left[\frac{(x - c_i)^2}{a_i} \right]^{b_i}} \quad (17)$$

where $\{a_i, b_i, c_i\}$ is the parameter set. As the values of these parameters change, the best bell-shaped functions vary accordingly, thus exhibiting various forms of membership functions on linguistic label A_i . In fact, any continuous and piecewise differentiable functions, such as commonly used trapezoidal or triangular-shaped membership functions are also qualified candidates for node functions in this layer. Parameters in this layer are referred to as premise parameters.

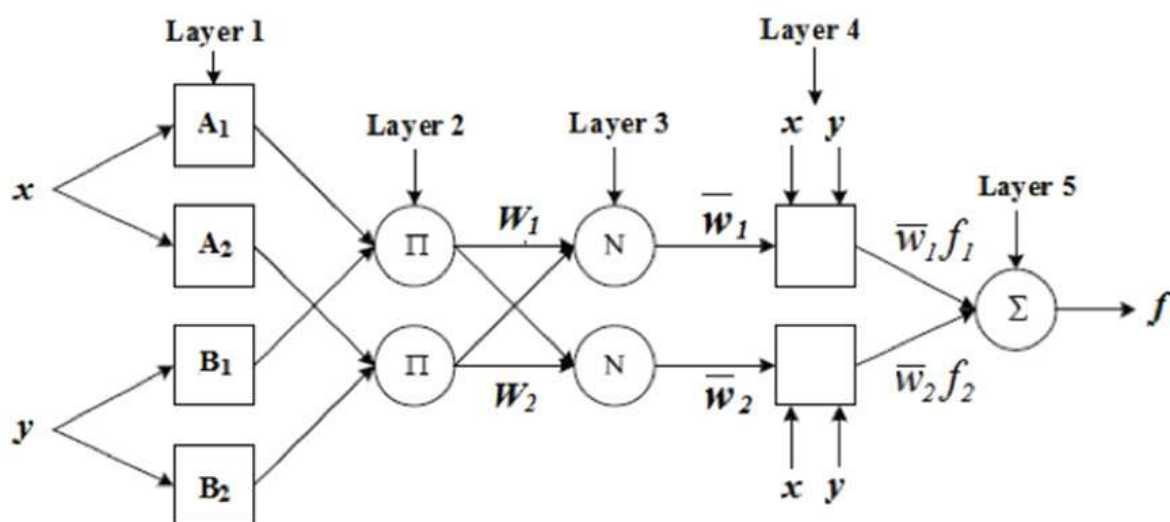

Fig. 5. ANFIS Architecture proposed by (Jang 1993).

Layer 2: Every node in this layer is a circle node labelled Π which multiplies the incoming signals and sends the product out. For instance,

$$w_i = \mu A_i(x) * \mu A_i(y), i = 1, 2 \quad (18)$$

Each node output represents the firing strength of a rule (In fact, other *T-norm* operators that perform generalized AND can be used as the node function in this layer).

Layer 3: Every node in this layer is a circle node labelled N. The *i*th node calculates the ratio of the *i*th rule's firing strength to the sum of all rules firing strengths:

$$\bar{w}_i = \frac{w_i}{w_1 + w_2}, i = 1, 2. \quad (19)$$

For convenience, outputs of this layer are called *normalized firing strengths*.

Layer 4: Every node in this layer is a square node with a node function

$$O_i^4 = \bar{w}_i f = \bar{w}_i (p_i x + q_i y + r_i) \quad (20)$$

Where \bar{w}_i is the output of layer 3, and $\{ p_i, q_i, r_i \}$ is the parameter set. Parameters in this layer will be referred to as consequent parameters.

Layer 5: The single node in this layer is a circle node labelled Σ that computes the overall output as the summation of all incoming signals, ie.

$$O_1^5 = \text{overalloutput} = \sum_i \bar{w}_i f = \frac{\sum_i w_i f}{\sum_i w_i} \quad (21)$$

Thus we have constructed an adaptive network which is functionally equivalent to a fuzzy inference system [8],[9]. The hybrid algorithm is applied to this architecture. This means that, in the forward pass of the hybrid learning algorithm, functional signals go forward up to fourth layer and the consequent parameters are identified by the least and consequent parameters are identified by the least squares estimation. In the last backward and the premise parameters are updated by the gradient descent [8].

9. Experimental results

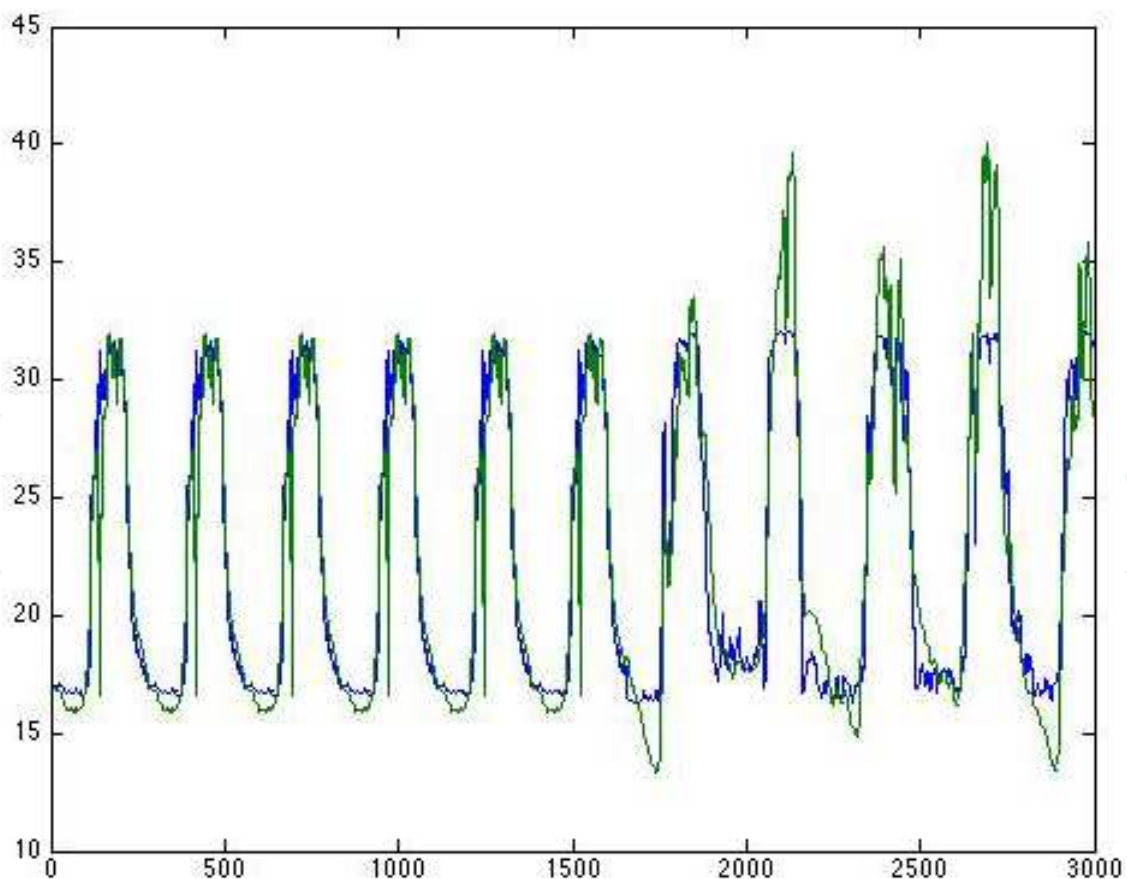

Fig. 6. Neural-Netorks Temperature Estimated.

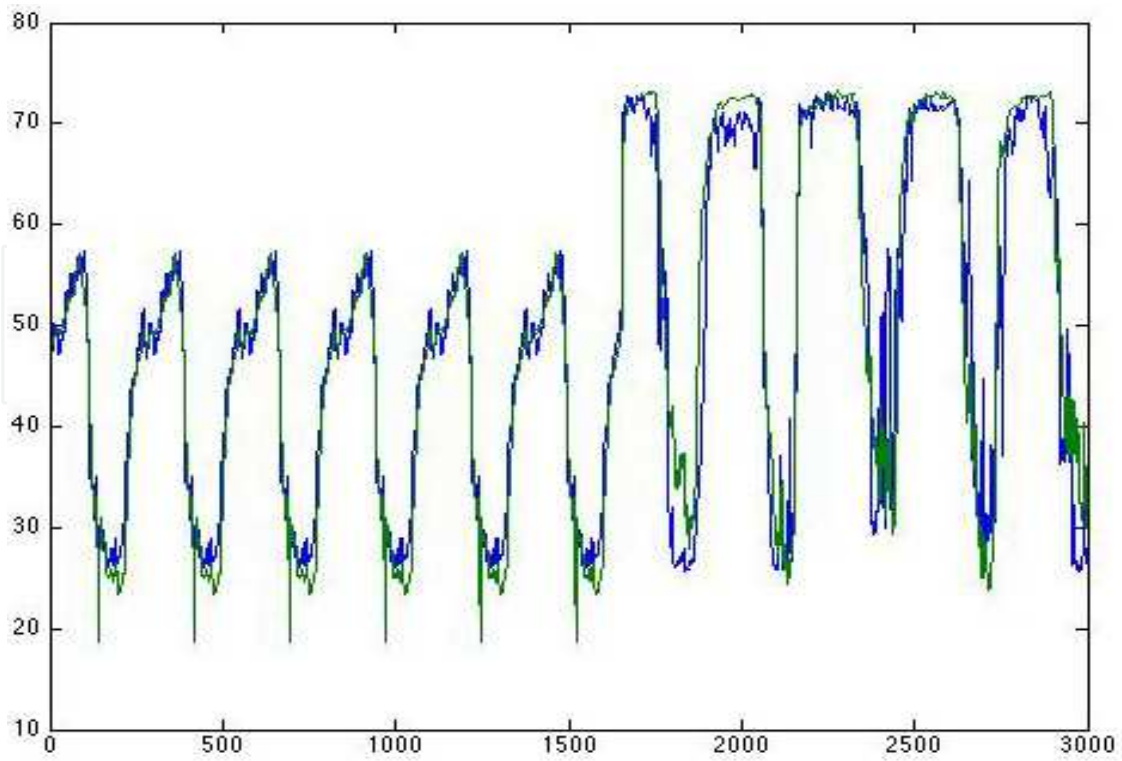

Fig. 7. Neural-Networks Humidity Estimated

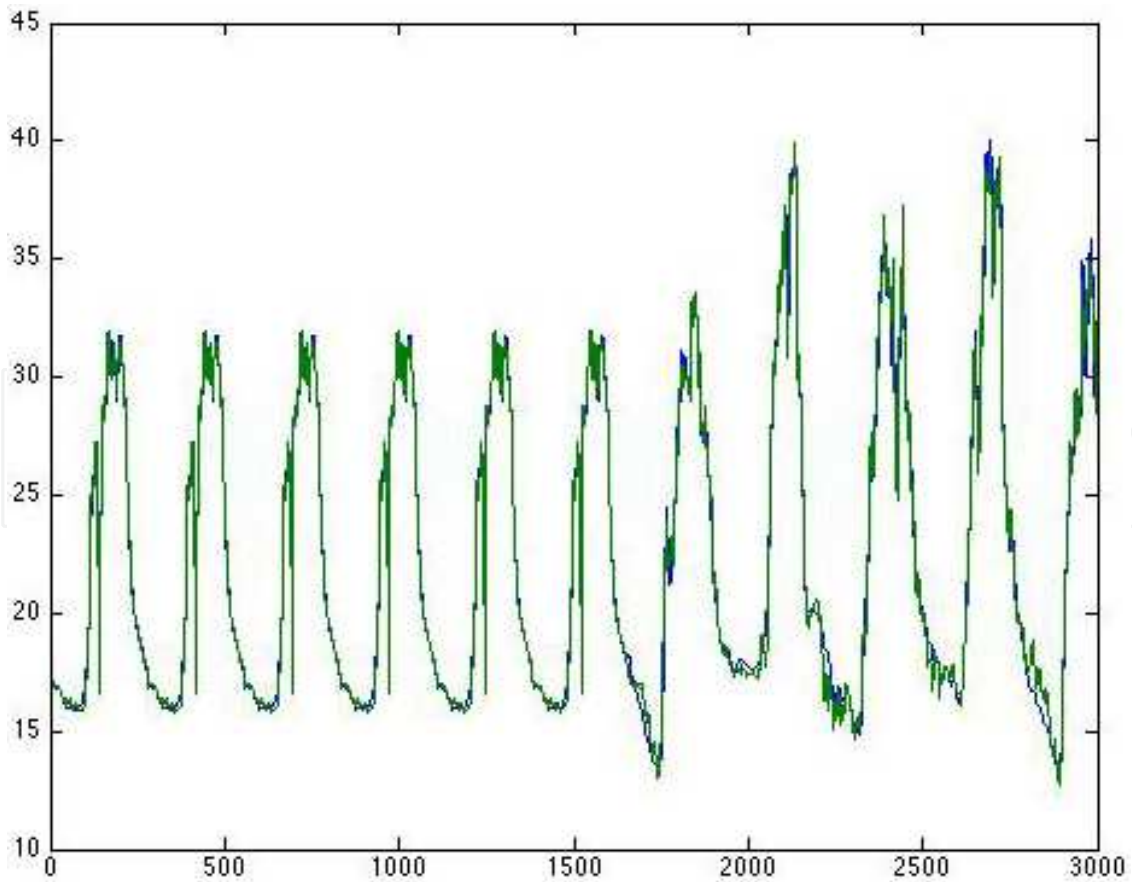

Fig. 8. ANFIS Temperature Estimated.

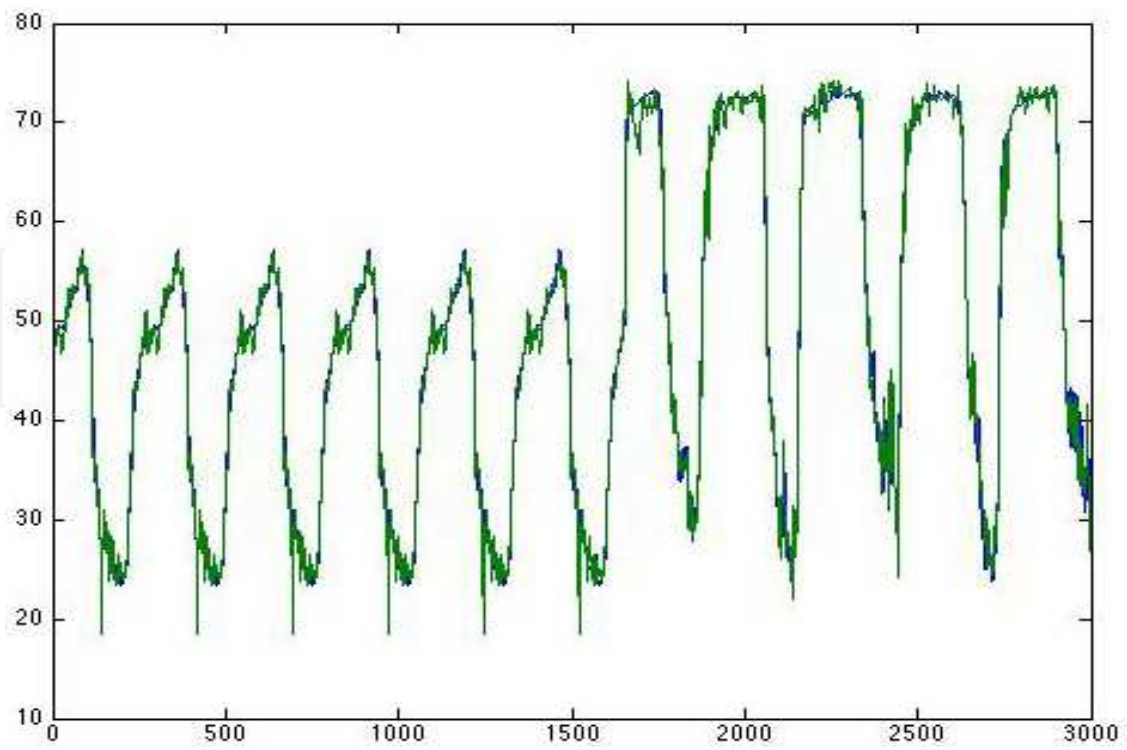

Fig. 9. ANFIS Humidity Estimated

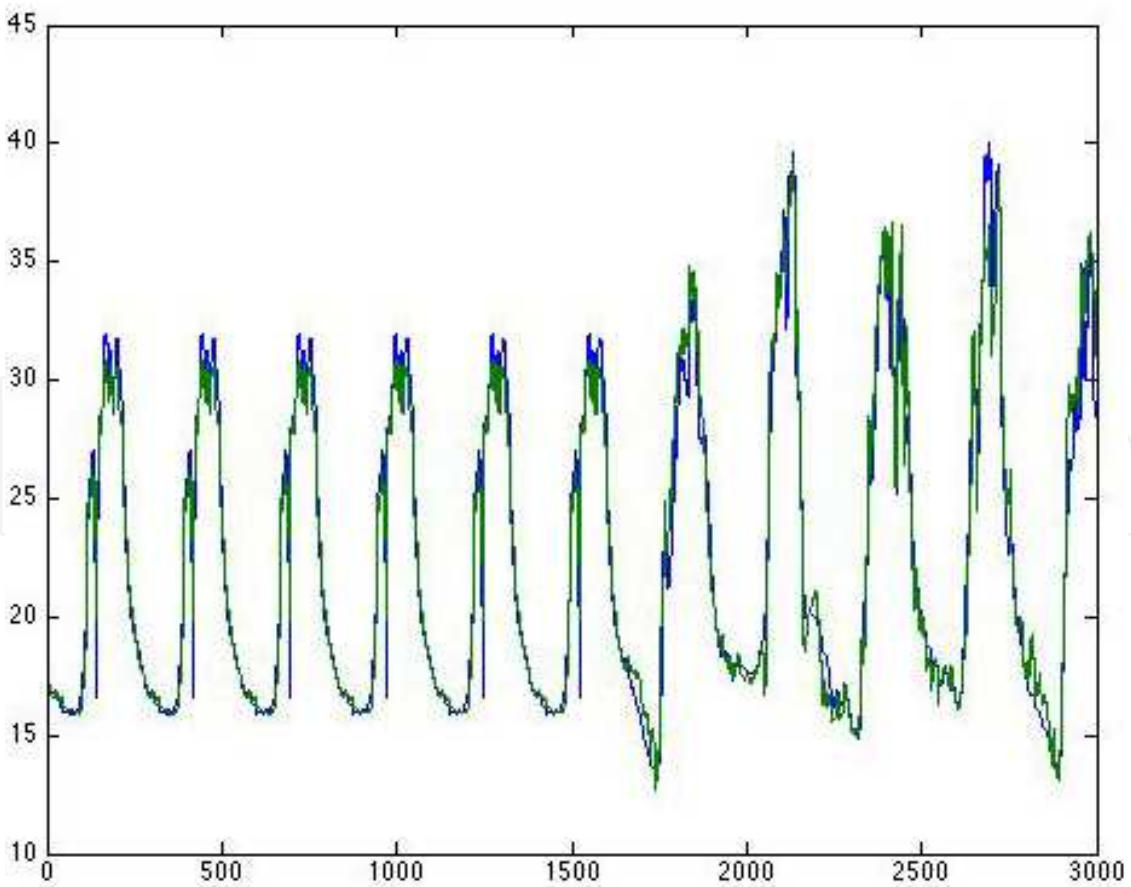

Fig. 10. Fuzzy Subtractive Clustering Temperature Estimated.

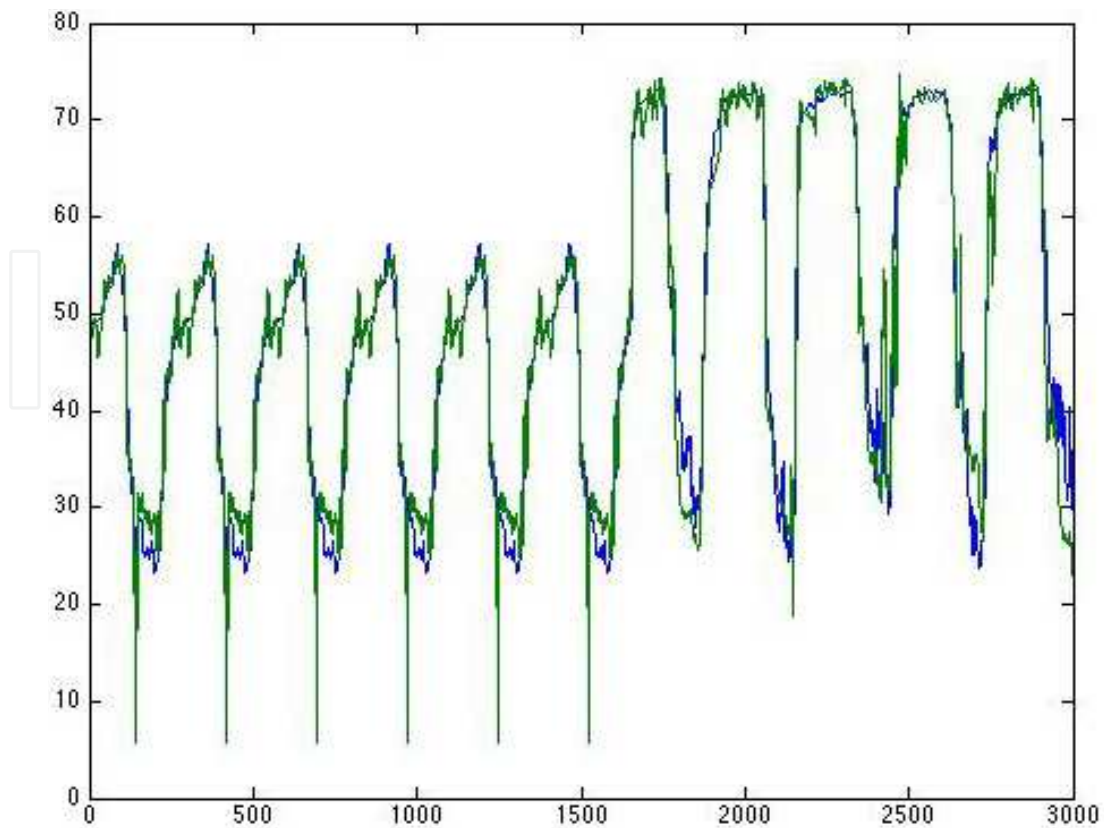

Fig. 11. Fuzzy Subtractive Clustering Humidity Estimated.

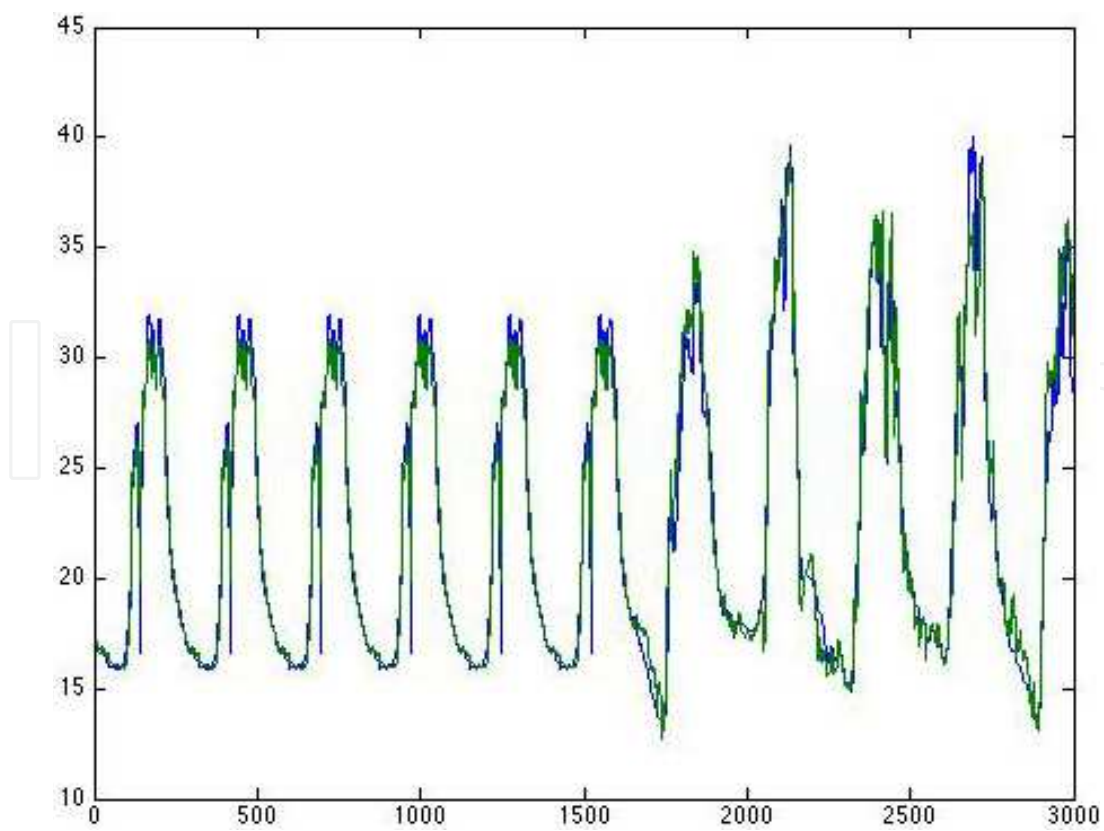

Fig. 12. Fuzzy C-Means Clustering Temperature Estimated.

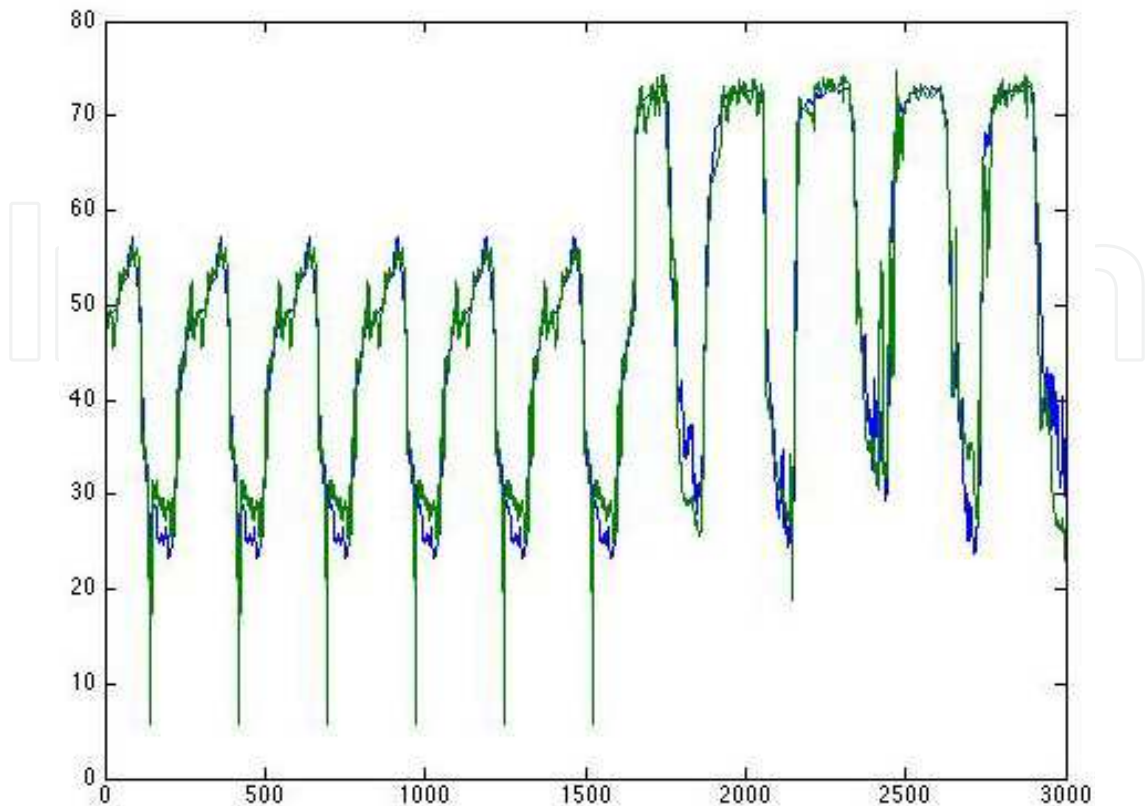

Fig. 13. Fuzzy C-Means Clustering Humidity Estimated.

Algorithm	Mean Average Error		Mean Square Error	
	Temperature	Humidity	Temperature	Humidity
ANN	1.3467	2.8587	4.3418	1.1590
ANFIS	0.3826	1.0634	0.3220	1.0634
Fuzzy Subtractive Clustering	2.2329	1.7653	12.4100	2.3595
Fuzzy C-Means	1.2329	0.7544	10.4050	1.5533

Table 1. Summary of Results

10. Conclusions and further work

In this chapter, we have introduced some clustering algorithms for fuzzy model identification, whose main purpose is modeling a system from experimental measured data.

Fuzzy model construction by clustering algorithms, however, will need further enhancement. For instance, mechanisms to find values for optimal cluster indexes still need further investigation because, determines the model structure. Here clustering evaluation functions and validation indexes could be of value when combined with genetic algorithms and support vector machines. The effectiveness of this approach will, however, depend on the accuracy of clustering techniques, and the issue still open. These are the questions to be addressed in future research.

11. References

- Bezdek, J. C., "Pattern Recognition with Fuzzy Objective Function Algorithms", *Plenum Press, NY*, 1981.
- Chang Wook A., "Advances in Evolutionary Algorithms: Theory, Design and Practice", Springer, ISSN: 1860-949X, 2006.
- Chiu S, "Fuzzy model identification based on cluster estimation", *Journal of Intelligent and Fuzzy Systems*; September 1994, 2, pp. 267-78.
- Ferreira, P.M., E.A. Faria and A.E. Ruano, 2002. Neural network models in greenhouse air temperature prediction. *Neurocomputing*, 2002 43: 51-75
- Gomez, A. F., M. Delgado, and M. A. Vila, "About the Use of Fuzzy Clustering Techniques for Fuzzy Model Identification", *Fuzzy Set and System*,. 1999, pp. 179-188.
- Guzman-Cruz, R., R. Castaneda-Miranda, J.J. Garia-Escalante, I.L. Lopez-Cruz, A. Lara-Herrera and J.I. de la Rosa, 2009. *Calibration of a greenhouse climate model using evolutionary algorithms*. *Biosyst. Eng.*, 104: 135-142
- Rico-Garcia, E., I.L. Lopez-Cruz, G. Herrera-Ruiz, G.M. Soto-Zarazua and R. Castaneda-Miranda, 2008. *Effect of temperature on greenhouse natural ventilation under hot conditions: Computational fluid dynamics simulations*. *J. Applied Sci.*, 8: 4543-4551.
- Rodrigo Castañeda-Miranda; Eusebio Jr. Ventura-Ramos; Rebeca del Rocío Peniche-Vera; Gilberto Herrera-Ruiz, *Fuzzy Greenhouse Climate Control System based on a Field Programmable Gate Array*, *Biosystems Engineering*. 2006 Vol. 94/2, pp 165-177
- Sin, S. K., and De Figueiredo, "Fuzzy System Designing Through Fuzzy Clustering and Optimal preDefuzzification", *Proc. IEEE International Conference on Fuzzy Systems*. 1993 2, 190-195.
- Sugeno, M., and G. T. Kang. "Structure Identification of Fuzzy Model", *Fuzzy Sets and Systems*. 1988, 28, pp. 15-33.
- Takagi, T., and M. Sugeno, "Fuzzy Identification of Systems and its Application to Modeling and Control", *IEEE Trans. Systems Man and Cybernetics*. 1985 -15, pp. 116-132.
- Rico-Garcia, E., I.L. Lopez-Cruz, G. Herrera-Ruiz, G.M. Soto-Zarazua and R. Castaneda-Miranda, 2008. *Effect of temperature on greenhouse natural ventilation under hot conditions: Computational fluid dynamics simulations*. *J. Applied Sci.*, 8: 4543-4551.
- Yager, R. and D. Filev, "Generation of Fuzzy Rules by Mountain Clustering", *Journal of Intelligent & Fuzzy Systems*, 1994, 2, pp. 209- 219.

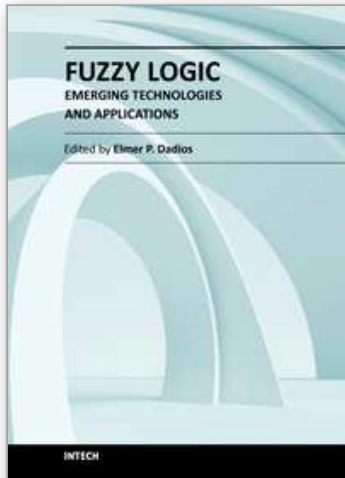

Fuzzy Logic - Emerging Technologies and Applications

Edited by Prof. Elmer Dadios

ISBN 978-953-51-0337-0

Hard cover, 348 pages

Publisher InTech

Published online 16, March, 2012

Published in print edition March, 2012

The capability of Fuzzy Logic in the development of emerging technologies is introduced in this book. The book consists of sixteen chapters showing various applications in the field of Bioinformatics, Health, Security, Communications, Transportations, Financial Management, Energy and Environment Systems. This book is a major reference source for all those concerned with applied intelligent systems. The intended readers are researchers, engineers, medical practitioners, and graduate students interested in fuzzy logic systems.

How to reference

In order to correctly reference this scholarly work, feel free to copy and paste the following:

Gorrostieta-Hurtado Efen, Pedraza-Ortega Jesus Carlos, Aceves-Fernández Marco Antonio, Ramos-Arreguín Juan Manuel, Tovar-Arriaga Saúl and Sotomayor-Olmedo Artemio (2012). Greenhouse Fuzzy and Neuro-Fuzzy Modeling Techniques, Fuzzy Logic - Emerging Technologies and Applications, Prof. Elmer Dadios (Ed.), ISBN: 978-953-51-0337-0, InTech, Available from: <http://www.intechopen.com/books/fuzzy-logic-emerging-technologies-and-applications/greenhouse-fuzzy-and-neuro-fuzzy-modeling-techniques>

INTECH

open science | open minds

InTech Europe

University Campus STeP Ri
Slavka Krautzeka 83/A
51000 Rijeka, Croatia
Phone: +385 (51) 770 447
Fax: +385 (51) 686 166
www.intechopen.com

InTech China

Unit 405, Office Block, Hotel Equatorial Shanghai
No.65, Yan An Road (West), Shanghai, 200040, China
中国上海市延安西路65号上海国际贵都大饭店办公楼405单元
Phone: +86-21-62489820
Fax: +86-21-62489821

© 2012 The Author(s). Licensee IntechOpen. This is an open access article distributed under the terms of the [Creative Commons Attribution 3.0 License](#), which permits unrestricted use, distribution, and reproduction in any medium, provided the original work is properly cited.

IntechOpen

IntechOpen