

We are IntechOpen, the world's leading publisher of Open Access books Built by scientists, for scientists

4,800

Open access books available

122,000

International authors and editors

135M

Downloads

Our authors are among the

154

Countries delivered to

TOP 1%

most cited scientists

12.2%

Contributors from top 500 universities



WEB OF SCIENCE™

Selection of our books indexed in the Book Citation Index
in Web of Science™ Core Collection (BKCI)

Interested in publishing with us?
Contact book.department@intechopen.com

Numbers displayed above are based on latest data collected.

For more information visit www.intechopen.com



Machinability of Titanium Alloys in Drilling

Safian Sharif¹, Erween Abd Rahim² and Hiroyuki Sasahara³

¹Universiti Teknologi Malaysia,

²Universiti Tun Hussein Onn Malaysia,

³Tokyo University of Agriculture and Technology,

^{1,2}Malaysia

³Japan

1. Introduction

1.1 Drilling technology

Hole making is an essential process in the structural frames of an aircraft and contributes to 40 to 60% of the total material removal operations (Brinksmeier, 1990). This process is commonly divided into short hole or deep hole drilling. Short hole drilling typically covers holes with a small depth to diameter ratio having diameter up to 30 mm and a depth of not more than 5 times the diameter. Meanwhile deep hole drilling caters for holes greater than 30 mm in diameter and the depths are usually greater than 2.5 times the hole diameter. Drilling deeper hole with conventional drills requires pecking method to enable easy flow of the chips out of the hole. Deep hole drilling is more difficult especially when hole straightness is the main concern. Therefore, a usual method is to make a circular cut using a hollow-core cutting tool. This technique allows larger hole diameter to be drilled with lesser power. In addition, holes can be produced in many forms which include through holes or blind holes (Fig. 1). Through hole is one which is drilled completely through the workpiece while a blind hole is drilled only to a certain depth.

A twist drill is fabricated with 3 major parts as shown in Fig. 2. The most important features from the analytical point of view are rake angle, point angle, web thickness, nominal clearance angle, drill diameter, inclination angle and chisel edge angle. The rake angle is usually specified as helix angle at the periphery. The direction of the chip flow is attributed to the point angle. The torque decreases with increasing point angle due to the increase of orthogonal rake angle at each point on the main cutting edges. Furthermore, the thrust force always increases with increasing point angle.

Fig. 3 shows the phases involved in a drilling operation, first is the start and centering phase, second is the full drilling phase and finally the break through phase (Tonshoff et al., 1994). To ensure good surface quality and accuracy of the holes are achieved, the first phase is very important (Fig. 3 (a)) in order to avoid the occurrence of premature wear and breakage of the drill. In this phase, the torque and force on the tool constantly increase. The full drilling phase starts once the main cutting edges are fully engaged (Fig. 3 (b)). The break through phase begins when the drill point breaks through the underside of the work piece and the process is stopped when the drill body passed through the work piece (Fig. 3 (c)).

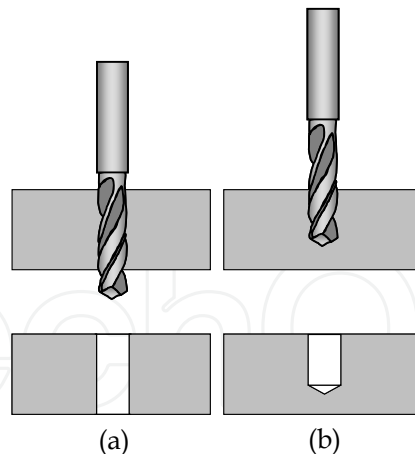

Fig. 1. Type of hole, (a) Through hole and (b) blind hole

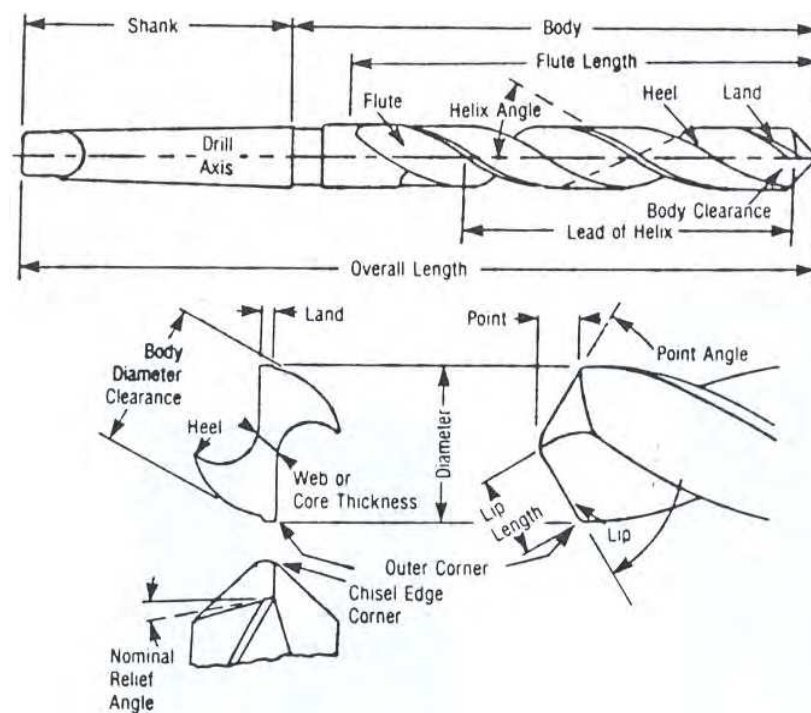

Fig. 2. Drill geometry (Lindberg, 1990)

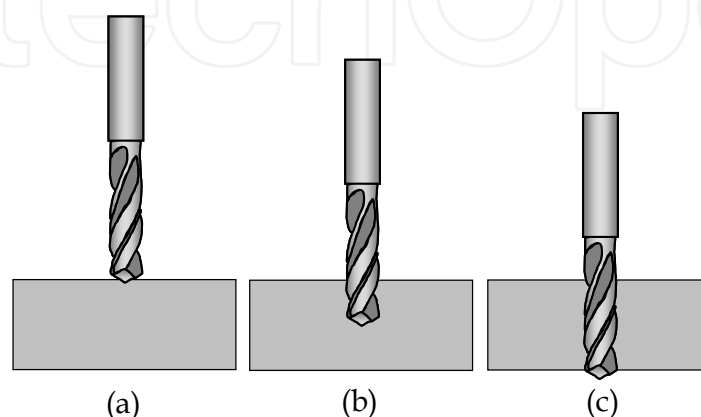

Fig. 3. Drilling phases, (a) centering phase, (b) full drilling phase and (c) break through phase

2. Tool wear in drilling process

Heat generation, pressure, friction and stress distribution are the main contributors of drill wear. The drill wear can be classified into (Kanai et al., 1978): outer corner (w), flank wear (V_b), margin wear (M_w), crater wear (K_M), along with two types of chisel edge wear (C_T and C_M) and chipping at the cutting lips (P_T and P_M). Fig. 4 shows the aforementioned types of wear. Wear starts at the sharp corners of the cutting edges and distributed along the cutting edges until the chisel and drill margin (Schnieder, 2001). Flank wear is considered as one of the criterion to measure the performance of a drill. It occurs due to the friction between the workpiece and the contact area on the clearance surface. However, Kanai et al. (1978) suggested that outer corner wear should be used as the main criteria of tool performance because of the relative ease of measurement and the close relationship between this type of wear and the drill life.

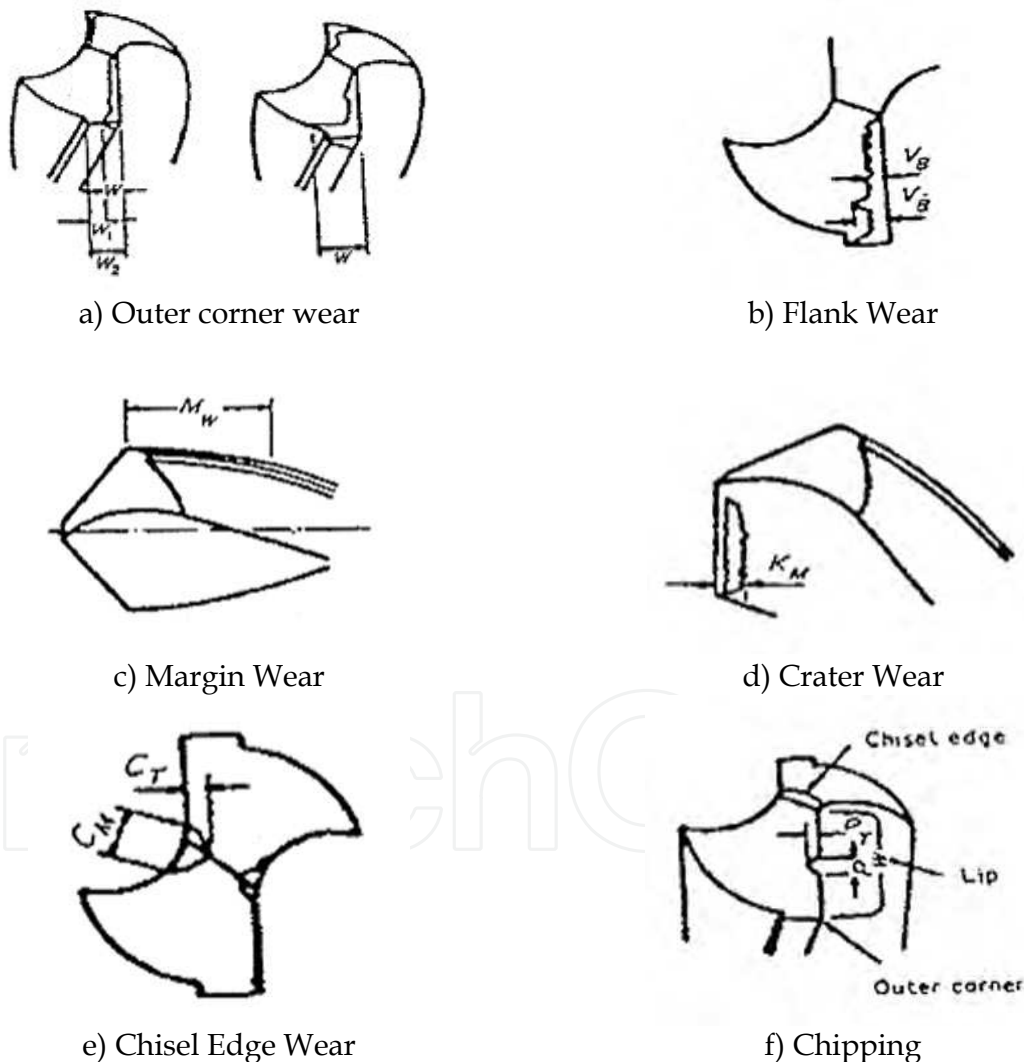

Fig. 4. Types of drill wear (Kanai et al., 1978)

Crater wear was also observed on the rake face of the drill and can be found clearly around the outer corners of the cutting edges (Choudhury & Raju, 2000; Kaldor & Lenz, 1980). According to Dolinsek et al., (2001), wear land behind the cutting edges is less significant as

an indicator of tool wear because it depends on the relief angle. They suggested that the drill will be considered damaged once the corner of the drill has been rounded off as shown in Fig. 5. However, Fujise and Ohtani (1998) and Harris et al. (2003) considered the outer corner wear as their tool rejection criteria (Fig. 6). The tools were rejected when the outer corner wear reached 75% of the total margin width. Kaldor and Lenz (1980) also employed the corner wear as the tool life criterion in drilling because of the similar wear behavior of other cutting tools.

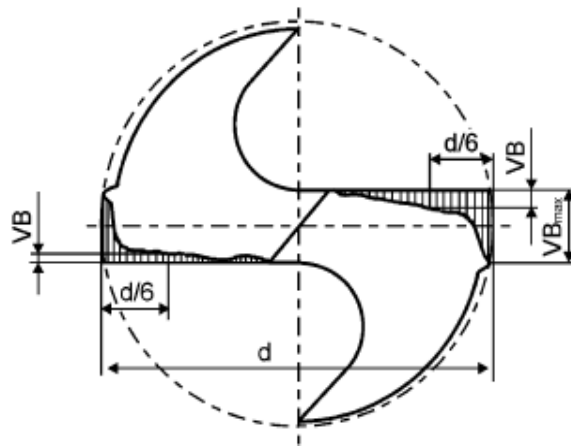

Fig. 5. Location of flank wear land on the drill (Dolinsek et al., 2001)

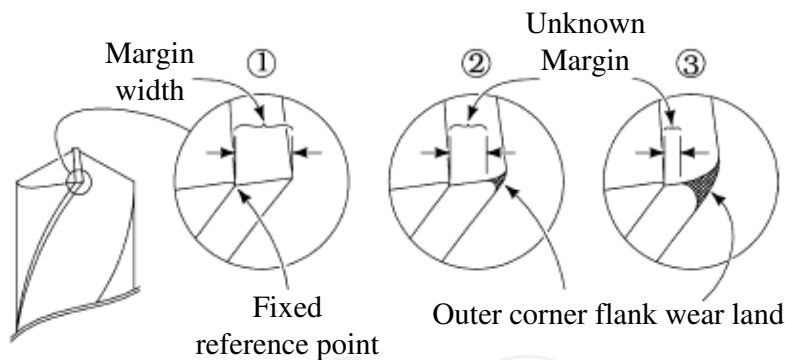

Fig. 6. A method to measure outer corner wear from a fixed reference point (Harris et al., 2003)

Tetsutaro & Zhao (1989) considered that the tool is rejected when the maximum flank wear width, $V_{b,max}$ reached 0.7 mm when drilling plain steel. Wen & Xiao (2000) used to measure the wear width developed on the flank surfaces when they drilled stainless steel. Lin (2002) rejected the tool based on the tool rejection criteria when maximum flank wear land exceeded 0.8 mm, surface roughness value exceeded $5.0 \mu\text{m}$, excessive outer corner tearing and chipping of the helix flutes. Choudhury & Raju (2000) have studied the influence of feed and speed on crater wear at different points along the cutting lip in drilling. Ezugwu & Lai (1995) rejected the drill bit when maximum flank wear in excess of 0.38 mm on any of the drill lips, a squeaking noise occurring during machining and fracture or catastrophic failure of the drill. These criteria were used when they investigated the drilling of Inconel 901 using HSS drills.

3. Titanium alloys

Lightweight materials such as titanium alloys are now being constituted in modern aircraft structure especially in jet engine components that are subjected to temperatures up to 1000° C. Titanium alloys possess the best combination of physical and metallurgical properties and have established to be quite attractive as engineering materials due to their high strength-to-weight ratio, low density, excellent corrosion resistance, excellent erosion resistance and low modulus of elasticity (Brewer et al., 1998)

Titanium alloys are classified into groups based on the alloying elements and the resultant predominant room temperature constituent phases. These groups include α alloy, α - β alloy and β alloy. The α alloys can be divided into two types, commercially pure grades of titanium and those with additions of α - stabilizers such as Al and Sn. α alloys are non-heat treatable and are generally very weldable. They have low to medium strength, good notch toughness, reasonably good ductility and possess excellent mechanical properties which offer optimum high temperature creep strength and oxidation resistance (Boyer, 1996; Ezugwu and Wang, 1997). These include alloys such as Ti-3Al-2.5V, Ti-5Al-2.5Sn, Ti-8Al-1Mo-1V and Ti-6Al-2Sn-4Zr-2Mo. A wide variety of application for α alloys includes gas turbine engine casings, air frame skin and structural components and jet engine compressor blades.

Most of the titanium alloys used in the industry contain α - and β - stabilizers. These alloys include Ti-6Al-4V, Ti-6Al-6V-2Sn and Ti-6Al-2Sn-4Zr-6Mo. They are heat treatable and most are weldable especially with the lower β - stabilizer. Their strength levels are medium to high. These alloys possess excellent combination of strength, toughness and corrosion resistance. Typical applications include blades and discs for jet engine turbines and compressors, structural aircraft components and landing gear, chemical process equipment, marine components and surgical implants. Meanwhile, β alloys contain small amounts of α -stabilizing elements as strengtheners and generally weldable, high corrosion resistance and good creep resistance to intermediate temperatures. Additions of vanadium, iron and chromium as stabilizing elements, provide superior hot working characteristics. Ti-10V-2Fe-3Al, Ti-15V-3Cr-3Al-3Sn, Ti-15Mo-2.7Nb-3Al-0.2Si and Ti-3Al-8V-6Cr-4Mo-4Zr are examples of these alloys. Typical applications include airframe components, fasteners, springs, pipe and commercial and consumer products.

4. Machinability of titanium alloys

Research works on the machinability of titanium alloys have been conducted extensively and reviewed comprehensively by several researchers. The increasing demands of titanium alloys with excellent high temperature, mechanical and chemical properties make them more difficult to machine. According to Ezugwu et al. (2003), machinability can be phrased as the difficulty to machine a particular material under a given set of the machining parameters such as cutting speed, feed rate and depth of cut. It can be rated in terms of tool life, surface quality, the reaction of cutting forces and also machining cost per part. Basically, work hardening, low thermal conductivity, abrasiveness, high strength level and high heat generated were the dominant reasons for the difficulty in machining titanium alloys. Heat is the most important factor that needs to be aware of when machining titanium alloys. Excessive heat could damage the cutting tool rapidly. The main sources of heat during machining are from the shear zone, from the tool-chip interface friction and from the tool-

workpiece interface friction. However, too much heat is not the only reason associated with tool failures. The lack of rigidity in holding the tool holder with cutting tool and workpiece can also shorten the tool life. Non-rigid setups with vibration or inconsistent cutting pressure and interrupted cuts often cause tool chipping or fracturing. Prolong machining also causes severe chipping and fracture of the tool edge.

5. Performance evaluation in drilling of titanium alloys

Among the various machining processes, drilling can be considerably as the most difficult process in comparison to milling and turning. Many researchers have studied the machinability of titanium alloys in the past, especially in turning and milling operations. Although extensive investigation reports have been published, no considerable progress is being made and reported on the drilling of these alloys.

5.1 Tool wear

Tool wear of cutting tools in metal cutting accounts for a significant portion of the production costs of a component. Tool wear occurs due to the physical and chemical interaction between the cutting tool and workpiece as a result of the removal of small particles of the tool material from the edge of the cutting tool. Tool wear takes place in three stages as shown in Fig. 7 (Vaughn, 1966). Tool wear developed rapidly in the initial stage and then grew uniformly until it reached its limiting value. In the third stage, the tool wear developed rapidly and caused tool failure. Machining beyond this limit will cause catastrophic failures on the tool and usually this should be avoided.

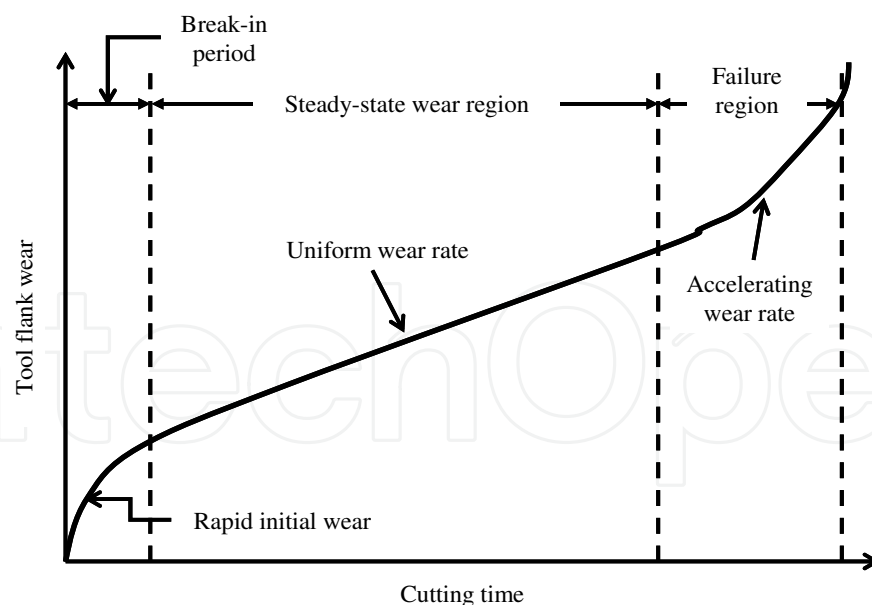

Fig. 7. Typical stages of tool wear in machining (Vaughn, 1966)

The main problem in drilling titanium and its alloys is the rapid wear of the cutting tool. Permissible rates of metal removal are low, in spite of the low cutting forces. The inhibitor in machining titanium alloys are the high temperature generated and the unfavorable temperature distribution in the cutting tool (Ezugwu & Wang, 1997; Vaughn, 1966). Due to

the low thermal conductivity of titanium alloys, the temperature on the rake face can be above 900° C even at moderate cutting speed.

Various types of wear can be observed when drilling titanium alloys, namely non-uniform flank wear, excessive chipping and micro-cracking. These types of wear are the dominant tool failure modes when drilling Ti-6Al-4V. The wear occurs along the drill's cutting edges or the flank faces. An increase in cutting speed led to a proportional increase in the flank wear width. The increase of flank wear rate may encourage adherence of workpiece material and may lead to attrition wear and eventually ended up in severe chipping.

During drilling of Ti-48Al-2Mn-2Nb, Mantle and co-workers (Mantle et al. (1995)) found that the workpiece material adhered to the chisel and the cutting edges. The adherence of Ti-48Al-2Mn-2Nb was thinner than Ti-6Al-4V and after verification under the SEM, they concluded that the adhered material was the main contributor to the tool failure. Titanium is highly chemically reactive with the tendency of welding onto the cutting tool during machining. In the beginning, the adhered material may protect the cutting edges from wear as shown in Fig. 8. In this figure, the adherence occurred mainly at the cutting edge, near the periphery and on the chisel edge. However with prolonged drilling, the adhered material becomes unstable and breaks away from the tool carrying along small amount of tool particles. This situation may lead to severe chipping on the cutting edge.

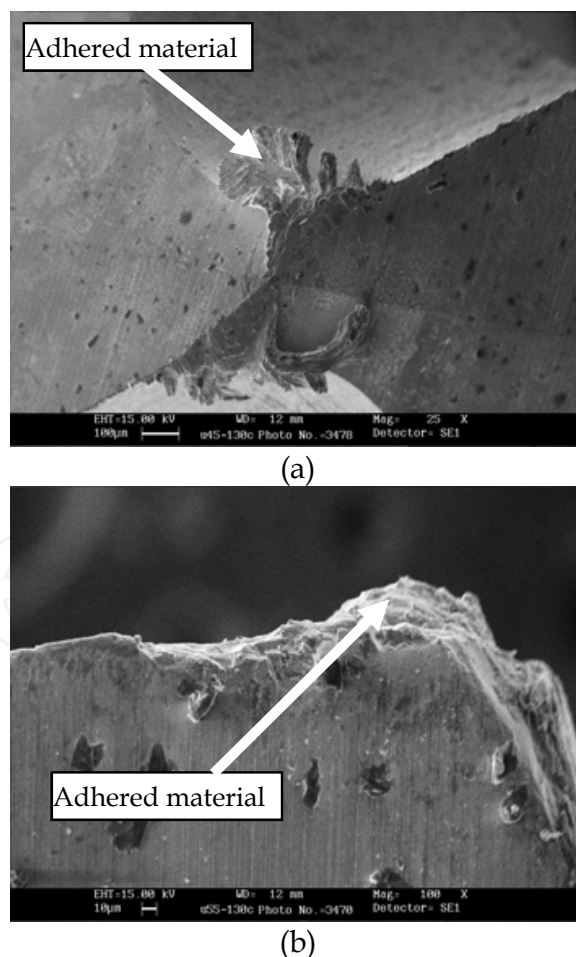

Fig. 8. Adherence of workpiece materials observed at: (a) chisel edge and (b) cutting edge of after drilling Ti-6Al-4V (Rahim, 2005)

Fig. 9 shows a thermal crack on the flank face of the drill (Rahim, 2005). It can be seen that the crack line propagated perpendicularly to the cutting edge. Cracks on the cutting tool and fracture of the entire cutting edge were mainly observed when machining titanium alloys at higher cutting conditions (Ezugwu et al., 2000; Jawaid et al., 2000). Cracks usually originate from the chipped area and gradually propagate along the worn flank face. Chipping at cutting edges is attributed mainly by the generation of cyclic surface stresses during drilling, which may lead to the stress cycling results in the formation of cracks parallel on the cutting edge. The propagation of cracks with prolonged machining, leads to chipping along the cutting edge. Chipping can also occur without the presence of crack formation, especially at the initial stages of the wear progress. If cracks become very numerous, they may join and cause small fragments of the cutting edge to break away.

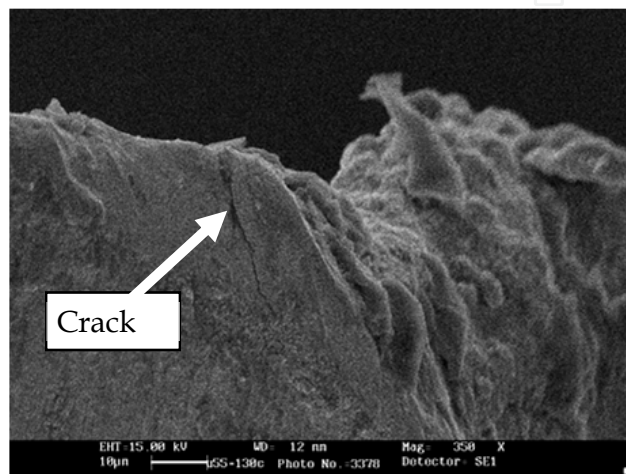

Fig. 9. Crack on the flank face after drilling Ti-6Al-4V for 1 minute at 55 m/min and 0.06 mm/rev (Rahim, 2005)

Cantero et al. (2005) reported on the approach in drilling Ti-6Al-4V under dry condition. Using a 6 mm diameter with TiN coated carbide drill, they recommended that speed and feed rate for drilling of Ti-6Al-4V were 50 m/min and 0.07 mm/rev respectively. Attrition and diffusion were the dominant tool wear mechanisms, especially in the helical flute of drill. With prolonged drilling, these tool wear mechanisms lead to the catastrophic failure of the drill. Attrition wear is a removal of grains or agglomerates of tool material by the adherent chip or workpiece (Dearnley and Grearson, 1986). This could be due to intermittent adhesion between the tool and the workpiece as a result of the irregular chip flow and the breaking of a partially stable built-up edge. When seizure between the tool and the workpiece is broken, small fragments of the tool can be plucked out due to weakening of the binder and transported material via the underside of the chip or by the workpiece. The presence of fatigue during machining operation can initiate cracks and also encourage cracks propagation on the tool.

Furthermore, diffusion wear is associated with the chemical affinity between the tool and workpiece materials under high temperature and pressure during machining of titanium alloys (Hartung and Kramer, 1982; Kramer, 1987). An intimate contact between the tool-workpiece interface at temperature above 800° C provides an ideal environment for diffusion of tool material across the tool-workpiece interface. The EDAX analysis (Fig. 10) confirmed that tool elements (C, Co and W) had diffused into the interface between tool-

workpiece during drilling Ti-6Al-4V (Rahim & Sharif, 2009). Diffusion wear is significant at the tool-workpiece interface, especially at high cutting temperature. Due to high chemical reactivity of titanium alloys, carbon reacts readily with titanium. Therefore, the formation of titanium carbide occurred at the interface between the tool and work material.

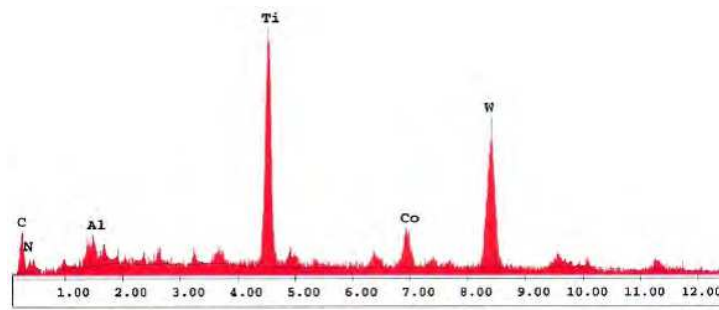
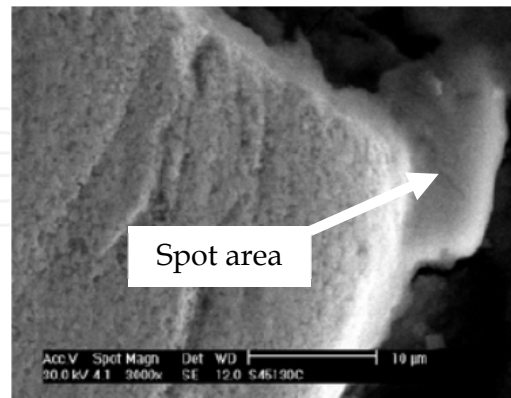

Fig. 10. EDAX Section of worn tool, showing adherent workpiece material on the cutting edge after drilling Ti-6Al-4V for 2 minutes at 45 m/min and 0.06 mm/rev (Rahim & Sharif, 2009)

5.2 Thrust force and torque

Piezoelectric dynamometer is commonly used to measure the cutting force in most machining processes. The various types of the dynamometer depend on the machining process such as turning, milling, drilling or grinding. A three components dynamometer is able to measure the cutting force and feed force, especially in milling and turning operations. Meanwhile, two components dynamometer is normally used in drilling process to measure the thrust force and torque.

Comparison of thrust force against the coolant-lubricant conditions at cutting speed of 60 m/min and feed rate of 0.1 mm/rev is presented in Fig. 11 (Rahim & Sasahara, 2011). It was found that the air blow condition produced the highest thrust force in comparison to the other coolant-lubricant conditions. In contrast, the MQLPO (palm oil using MQL condition) and flood conditions exhibited comparable and the lowest thrust force among the other conditions tested. As expected, the flood condition demonstrated the lowest torque among the other conditions tested as shown in Fig.12. Through the comparison, it was found that air blow did not reduce the drilling torque as much as the other coolant-lubricant conditions. They concluded that the highest value of thrust force and torque for the air blow condition could be attributed to higher amount of friction between tool-chip interface, hence, more heat is generated during the drilling process. Furthermore, Lopez and co-

workers found that the cutting force produced by high pressure internal cooling method was lower compared with the external cooling, which has a beneficial effect on workpiece deformation and hole quality (Lopez et al. , 2000).

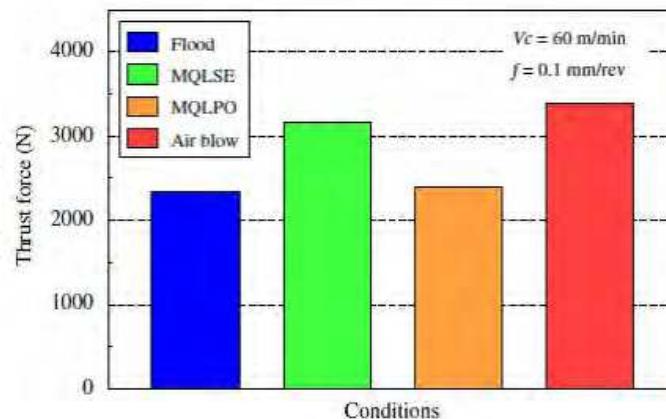

Fig. 11. Thrust force when high speed drilling of Ti-6Al-4V under various coolant-lubricant conditions (Rahim & Sasahara, 2011)

The influence of drilling parameters has been assessed for different material characteristic and properties of titanium alloys (Mantle et al. ,1995). Result shows that the thrust force and torque for Ti-48Al-2Mn-2Nb were greater than Ti-6Al-4V. As shown in Figs. 13 and 14, the thrust force decreases as cutting speed increases (Rahim et al., 2008). At the same time, results also showed that low torque values were obtained at the highest cutting speed. This behavior is attributed to the reduction of the contact area between the tool-workpiece interface and the reduction of specific cutting energy. Moreover, with increase of cutting speed, the cutting temperature increases, subsequently reduced the material hardness. As a result, both the thrust force and torque are reduced. Meanwhile, the thrust force and torque values were significantly increased when the feed rate was increased as shown in Fig. 15 (Rahim & Sasahara, 2011). The thrust force and torque are strongly correlated with the chip thickness, which is associated with the feed rate (Liao et al., 2007). This is because high feed rate results in a larger cross sectional area of the undeformed chip, and, consequently, greater thrust force and torque are produced.

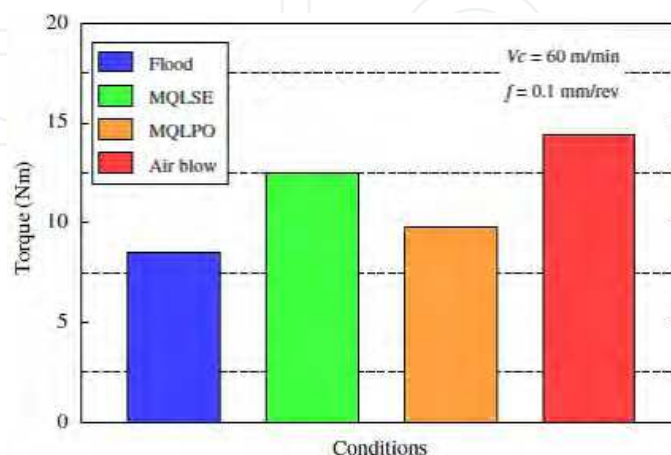

Fig. 12. Torque when high speed drilling of Ti-6Al-4V under various coolant-lubricant conditions (Rahim & Sasahara, 2011)

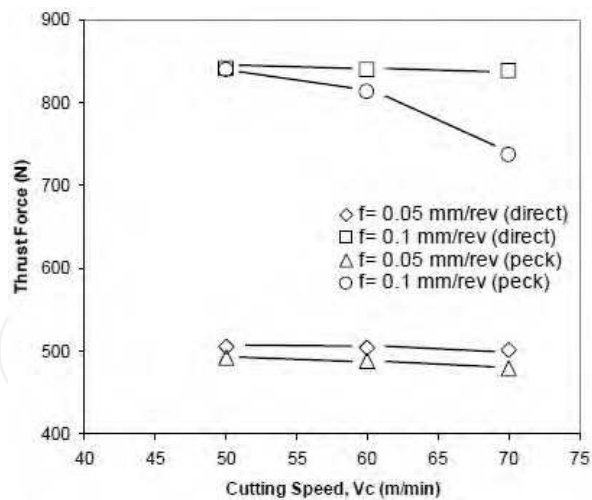

Fig. 13. Comparison of thrust force when drilling Ti-6Al-4V using cemented carbide tool under flood coolant condition (Rahim et al., 2008)

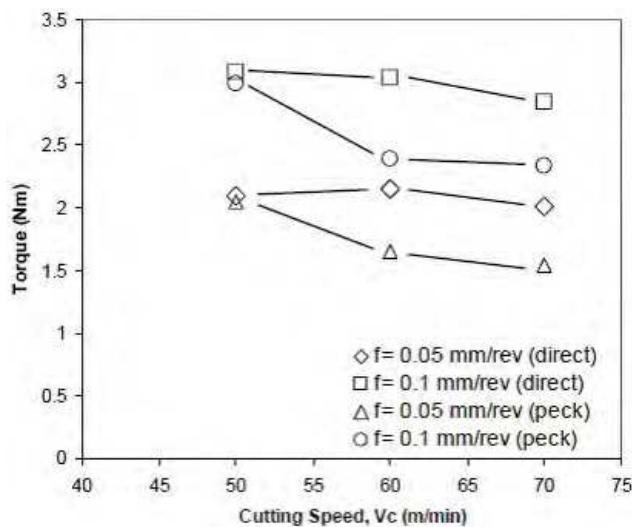

Fig. 14. Comparison of torque when drilling Ti-6Al-4V using cemented carbide tool under flood coolant condition (Rahim et al., 2008)

Some researchers have tested several techniques in drilling of titanium alloys. A step feed drilling or intermittently decelerated feed drilling and vibratory drilling were conducted by Sakurai co-workers (Sakurai et al., 1992; Sakurai et al., 1996) to examine the cutting force and cutting characteristic of TiN coated cobalt HSS and oxide treatment nitridized cobalt HSS when drilling Ti-6Al-4V. Results of their study showed that step feed drilling contributed a lower thrust force and torque as compared to continuous conventional drilling. In addition, the thrust force and torque on TiN drills are lower than oxide treatment nitridized drills in both conventional and step feed drilling. As reported by Okamura and co-workers (Okamura et al., 2006), the non-vibration drilling shows a tremendous reduction on thrust force. However, the value tends to decrease once the vibration exceeded 20 kHz. It is believed that the natural frequency of measurement systems does not exceed the vibrating frequency. In another work by Rahim and co-workers (Rahim et al., 2008) showed that pecking drilling method significantly reduces the thrust force and torque.

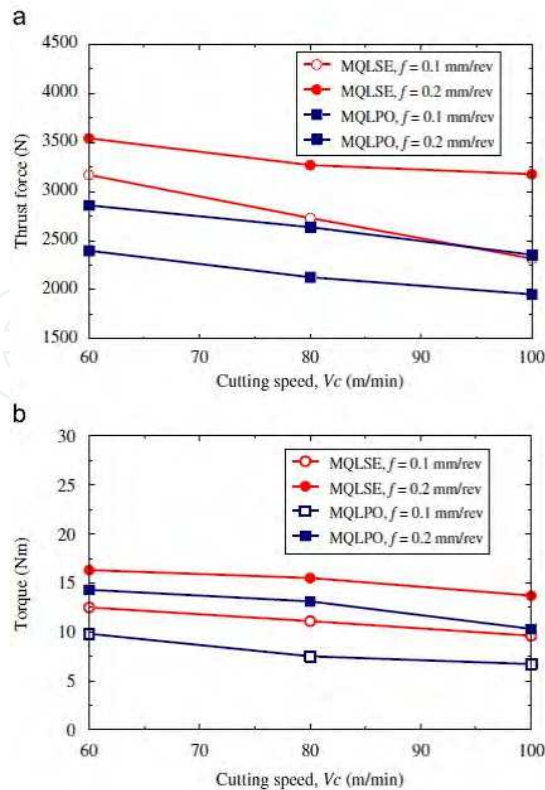

Fig. 15. (a) Thrust force and (b) torque for MQLSE and MQLPO under various cutting speed and feed rate (Rahim & Sasahara, 2011)

5.3 Temperature

Embedded thermocouples were one of the earliest technique used for the estimation of temperatures in various manufacturing and tribological applications. In order to use this technique, particularly in machining, a number of fine deep holes have to be made in the stationary part, namely the workpiece or the cutting tool, and the thermocouples are inserted in different locations in the interior of the part, with some of them as close to the surface as possible. In drilling process, the measurement of temperature by thermocouple wires can be done by embedding the wires in the workpiece and cutting tool as shown in Figs. 16, 17, 18 and 19, respectively. These methods are able to measure the workpiece and cutting tool temperature, especially when drilling titanium alloys.

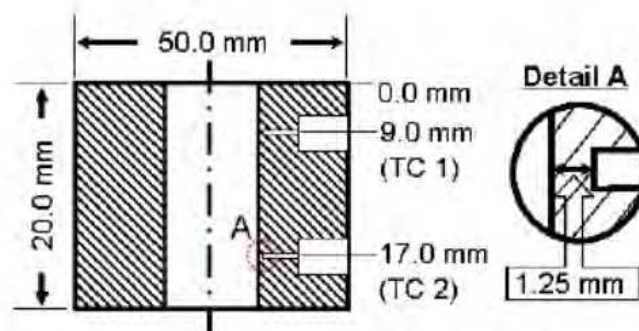

Fig. 16. Thermocouple locations (Rahim & Sasahara, 2010a)

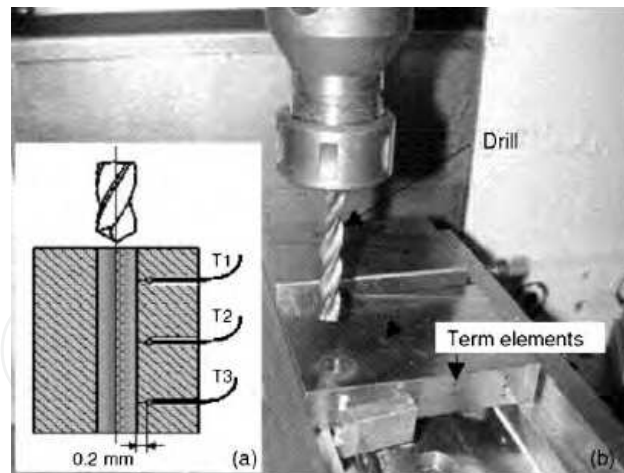

Fig. 17. System for measurement of the temperature in the workpiece (Zeilmann & Weingaertner, 2006)

Cutting speed and feed rate are among the factors that contribute to the variation of temperature during drilling titanium alloys. The cutting temperature increases with the cutting speed. This corresponds with the high cutting energy, deformation strain rate as well as the heat flux (Rahim & Sasahara, 2011). Furthermore, drilling at high feed rate increases the friction and stresses, thus increasing the cutting temperature.

The application of different cooling methods provides a variation in temperature results. For example, the maximum temperatures recorded for drilling with abundant emulsion through the interior of the tool stayed in the range of 22–32% of the values obtained with the application of MQL with an external nozzle as shown in Fig. 20 (Zeilmann & Weingaertner, 2006). Comparing drilling with MQL applied with an external nozzle and dry drilling, the values obtained for the second condition were approximately 6% superior, ranging from 455 to 482 °C. Furthermore, flood and MQL conditions recorded a low workpiece temperature in comparison to the air blow condition as shown in Fig. 21 (Rahim & Sasahara, 2011).

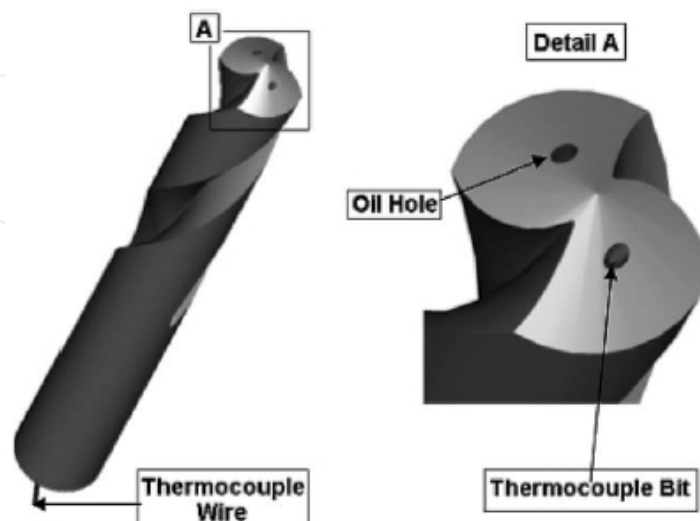

Fig. 18. The thermocouple was inserted through the oil hole of internal coolant carbide drill (Ozcelik & Bagci, 2006)

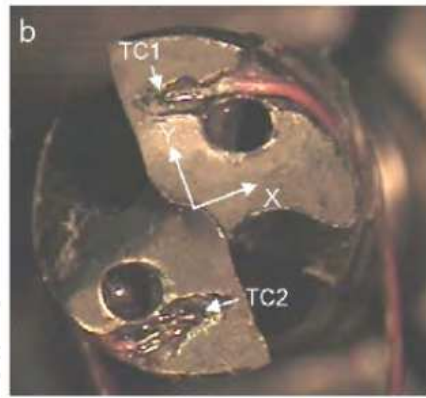

Fig. 19. Top view and coordinates of thermocouple tips on drill flank face (Li & Shih, 2007)

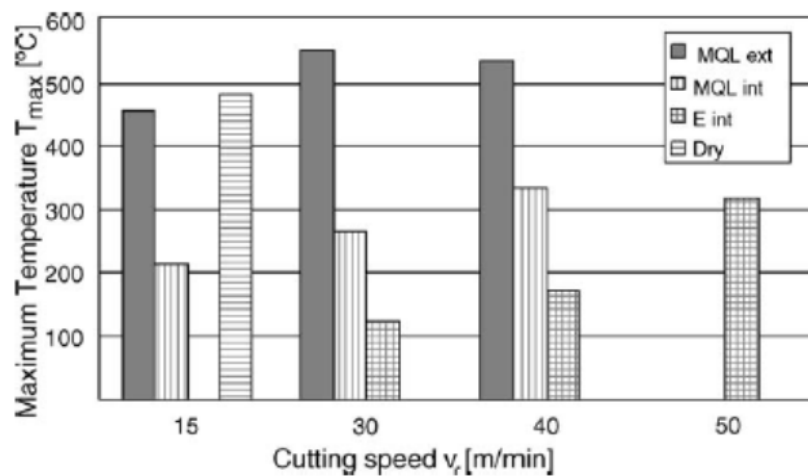

Fig. 20. Maximum temperature in the piece for different cutting fluids conditions when drilling Ti-6Al-4V using grade K10 cemented carbide tool (Zeilmann & Weingartner, 2006)

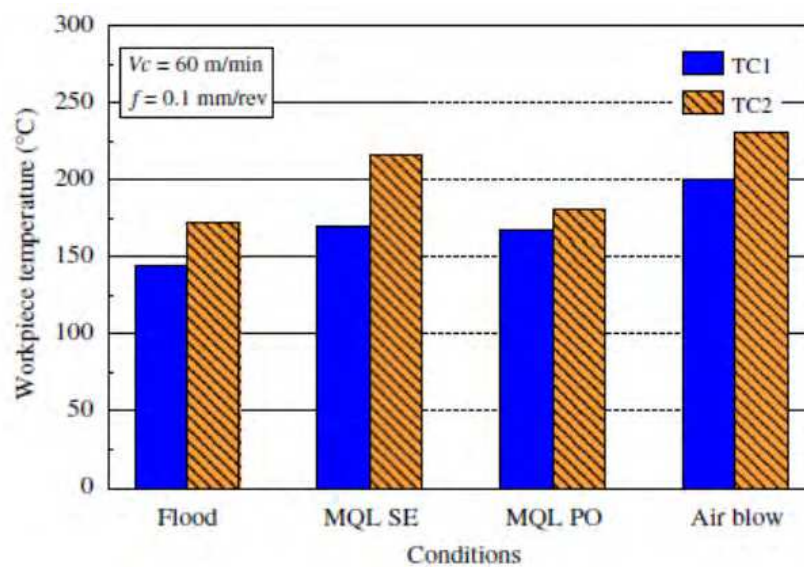

Fig. 21. Maximum workpiece temperature in high speed drilling of Ti-6Al-4V under various coolant-lubricant conditions (Rahim & Sasahara, 2011)

As reported by Pujana and co-workers (Pujana et al., 2009), the cutting temperature was higher when using ultrasonic-assisted drilling in comparison to the non-vibration drilling. In this case, the higher the vibration amplitude, the higher the temperature variations. Okamura and co-authors (Okamura et al., 2006) have designed a low-frequency vibration drilling machine to drill a Ti-6Al-4V. They described the effect of low-frequency vibration drilling on cutting temperature. Results showed that, higher amplitude of 0.24 mm and frequency of 30 Hz exhibited lower cutting temperature as compared to non-vibration drilling.

6. Surface integrity

Surface integrity is defined as the unimpaired or enhanced surface condition of a material resulting from the impact of a controlled manufacturing process (Field and Kahles, 1964). Damaged layer and surface integrity of the finished surface significantly influence the wear resistance, corrosion resistance and fatigue strength of the machined components. Surface integrity produced by metal removal operation can be categorized as geometrical surface integrity and physical surface integrity. To find the impact of the manufacturing process on the material properties both categories effects must be considered. Surface integrity aspects are very important, especially in aerospace industry with respect to the high degree of safety. Surface integrity is concerned primarily on the effect of the machining process on the changes in surface and sub-surface of the component which are categorized as surface roughness, plastic deformation, residual stress and microhardness.

6.1 Surface roughness

There are three essential parameters in a surface roughness; arithmetical mean deviation of the profile (R_a), maximum height of the profile (R_{max}) and height of the profile irregularities in ten points (R_z). It is believed that the higher surface roughness value is responsible for the decrease of the fatigue strength on the machined surface. Significant improvement in surface roughness can be obtained when low feed rate and high cutting speed are employed. However, the response of surface roughness towards cutting speed was less significant when compared to feed rate. Sun and Guo (Sun & Guo, 2009), reported that surface roughness value increased with increase in feed rate and radial depth-of-cut.

Previous study showed that surface roughness value is lower at high cutting speed when drilling Ti-6Al-4V using carbide drills (Sharif & Rahim, 2007). During machining at high cutting speed, the cutting temperature increases due the small contact length between tool-workpiece interfaces. This could be due to the decrease in the value of coefficient of friction, which results in low friction at the tool-workpiece interface. These factors could contribute to the improvement in surface roughness values as shown in Fig. 22 (Rahim & Sasahara, 2010b). In addition, as the cutting speed increases, more heat is generated thus softening the workpiece material, which in turn improves the surface roughness. However, a low cutting speed may lead to the formation of built-up edge and hence deteriorates the machined surface. Investigation revealed that at high feed rate the surface roughness is poor, probably due to the distinct feed marks produced at high feed rate (Rahim & Sasahara, 2010)

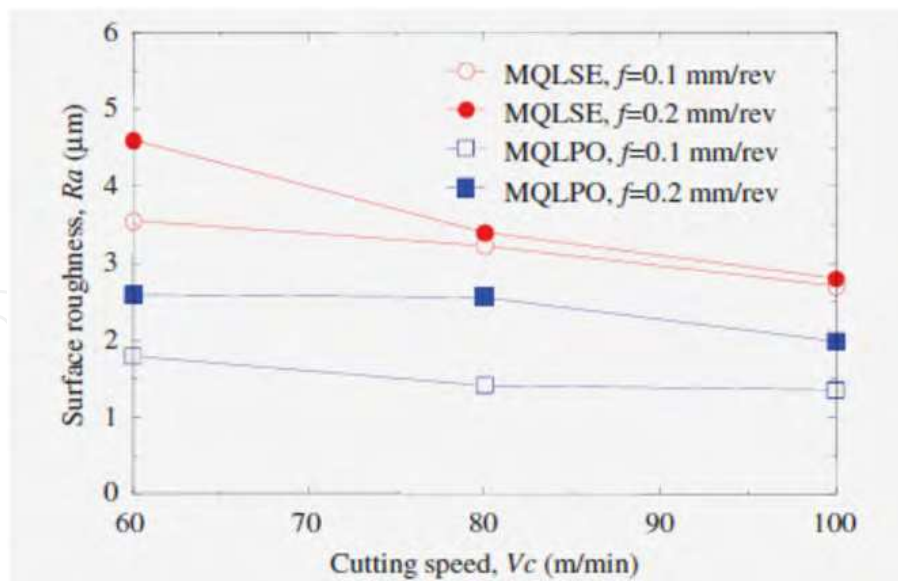

Fig. 22. Comparison of surface roughness level obtained when drilling Ti-6Al-4V using TiAlN coated carbide tool under MQLSE and MQLPO (Rahim & Sasahara, 2010b)

Types of cutting fluid also influence the surface roughness of the machined surface. Under the MQL condition, vegetable oil (MQLPO: palm oil) exhibits better surface roughness than synthetic ester (MQLSE) as shown in Fig. 22 (Rahim & Sasahara, 2010b). It can be suggested that less heat is generated using palm oil thus provided enough time to cool and lubricate the tool-workpiece interface. Apparently, such reduction may attribute to better lubrication and shorter tool-chip contact length during drilling. Moreover, surface roughness measured by peck drilling is far better than conventional drilling method (Rahim et al, 2008).

6.2 Microhardness

The microhardness alterations observed during machining may be due to the effect of thermal, mechanical and chemical reaction. Many researchers believed that the workpiece material is subjected to work hardening and thermal softening effect during machining, especially at high cutting temperature and pressure (Che Haron, 2001; Ginting & Nouari, 2009). When machining titanium alloys, the hardness just beneath the machined surface was found to be softer than the bulk material hardness due to the thermal softening effect. However, when the depth below the machined surface increases, the hardness value starts to increase before reaching its peak value and finally drops gradually to the bulk material hardness as shown in Fig. 23. The increase in hardness value is directly associated with the effect of work hardening. This effect depends on the temperature, cutting time and the mechanism of internal stress relaxation (Ginting and Nouari, 2009).

Fig. 23 shows that the microhardness of the sub-surface at 0.025 mm underneath the machined surface was below the average base material hardness. This indicates that the machined surface experienced thermal softening effect or over aging due to the localized heating during the drilling process (Rahim & Sasahara, 2010b). Turning test of titanium alloys by Haron and Jawaid (Haron & Jawaid, 2005) and Ginting and Nouari (Ginting & Nouari, 2009) have also indicated significant drop of microhardness value near the surface of machined layer. They pointed out that the existence of high cutting temperature and high cutting pressure produced noticeable softening in the surface region.

Fig. 23 also shows that there is hardening layer below the softened layer whose hardness depends on the cutting parameters (i.e cutting speed, feed rate, depth of cut) as well as mechanical and thermal interaction. It was generally observed in the work hardening region that the microhardness increases with increase in cutting speed and feed rate. An increase in microhardness of the surface layer, as a result of high feed rate could be associated by the high rubbing load between the tool and the machined surface and the consequent work hardening effect.

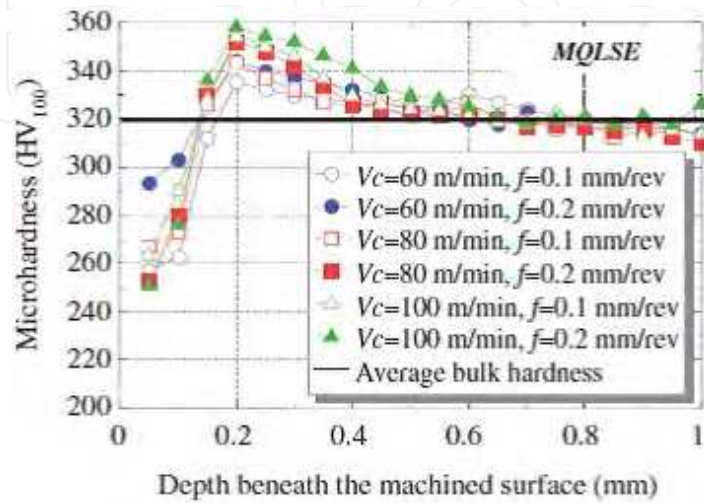

Fig. 23. Sub-surface hardness variations after drilling Ti-6Al-4V using MQLSE (Rahim & Sasahara, 2010b)

In another work by Rahim and Sharif (Rahim & Sharif, 2006), it was reported that the hardness value underneath the drilled surface was higher than the average hardness of the bulk material when drilling Ti-5Al-4V-Mo/Fe (Fig. 24). Meanwhile, a significant changed of microhardness values were also observed underneath the machined surface. It was due to the transformation of beta phase to alpha phase during drilling (Cantero et al., 2005).

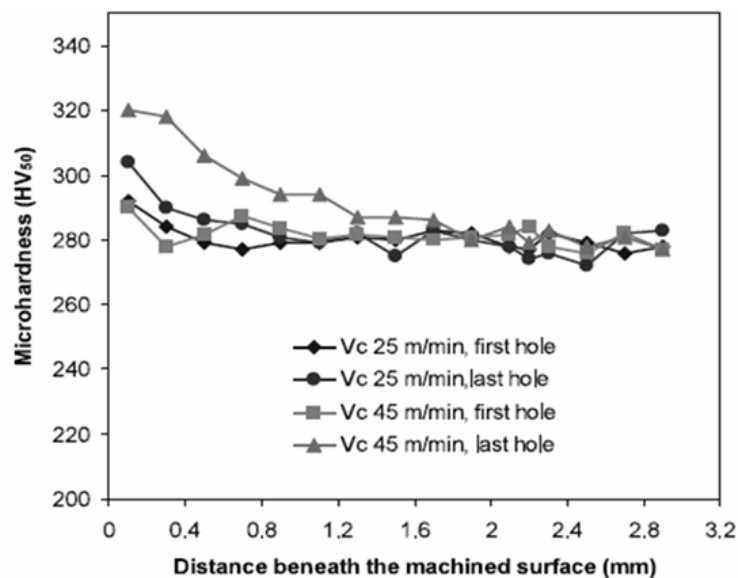

Fig. 24. Microhardness variation beneath the surface produced when drilling Ti-5Al-4V-Mo/Fe (Rahim & Sharif, 2006)

6.3 Sub-surface plastic deformation

It is discernible that the surface and sub-surface of the machined surface are subjected to plastically deform. Sub-surface plastic deformation is particularly due to the effect of large strain, strain rate and temperature. In addition, a freshly cut surface may be burnished by a dull cutting tool, hence work hardened the machined surface. Jeelani and Ramakrishnan (Jeelani & Ramakrishnan, 1983) observed that the machined surface is severely damaged with the plastic flow in the direction of the tool motion. Meanwhile, Velasques and co-workers (Velasques et al., 2010) found that the severe deformation beneath the machined surface is associated with high cutting speed. Sub-surface plastic deformation area can be divided into three zones, namely highly perturbed region, a plastically deformed layer and unaffected zone. Normally, the sub-surface plastic deformations of microstructure of the machined surfaces are examined under the high magnification microscope in etched condition.

In most cases, plastic deformation occurs towards the spindle rotational direction. When drilling titanium alloys at higher cutting speeds and feed rates, a thicker plastic deformation can be observed. At this condition, the temperature between tool-chip interface increases thus sticking friction region occurred. Therefore, the combination of high cutting temperature and sticking friction contributed to the severe and noticeable subsurface plastic deformation (Rahim & Sasahara, 2010).

Fig. 25 shows an evidence of sub-surface plastic deformation when drilling Ti-5Al-4V-Mo/Fe (Rahim & Sharif, 2006). In this figure, the deformation is found to be severe after prolonged drilling. In this case, no white layer especially on the top of the machined surface is observed. The authors stated that high cutting force and temperature are the dominant factors which lead to the severe plastic deformation. Cantero and co-workers (Cantero et al., 2005) also found the same phenomenon and they concluded that the plastic deformations during machining are caused by mechanical forces from the cutting tool acting upon the work-piece. Additional deformation can occur as a consequence of temperature gradients due to localized heating of the machined surface area.

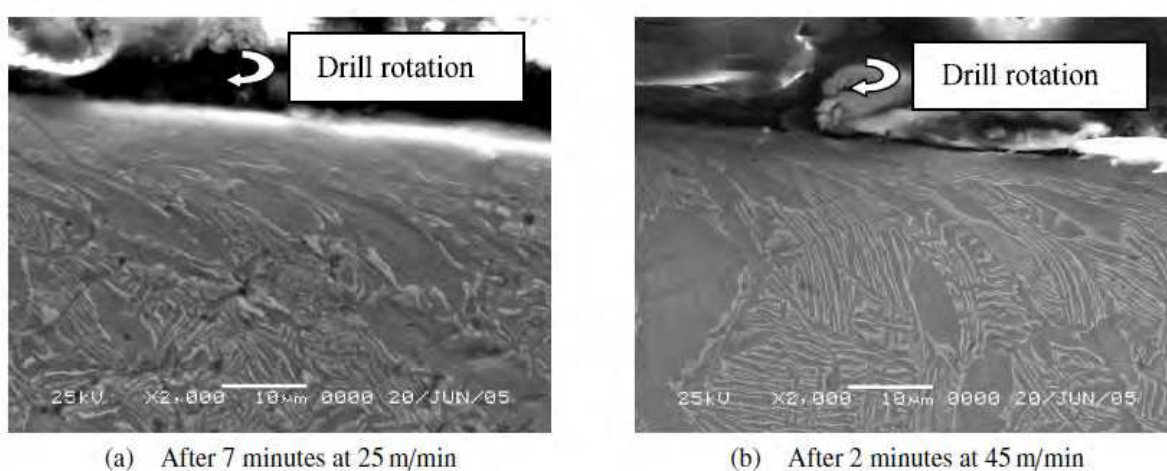

Fig. 25. Magnified view of the machined sub-surface when drilling Ti-5Al-4V-Mo/Fe (Rahim & Sharif, 2006)

7. Conclusions

Creditable works have been carried out by many researchers in drilling of titanium alloys which resulted in significant improvements in the productivity of titanium parts. The application of drilling strategies, introduction of newly developed tool geometry and coolant conditions have improved the surface integrity and increased the tool life performance of the cutting tools in several folds. In general the following conclusions can be drawn when drilling titanium alloys:

- i. Adhesion, attrition and diffusion are the operating tool wear mechanisms when drilling titanium alloy.
- ii. Flank wear, excessive chipping, cracking and tool breakage are the dominant tool failure modes.
- iii. The values of thrust force and torque decrease with increase in cutting speed. In contrast, these values increase significantly when the feed rate is increased.
- iv. Cutting speed and feed rate significantly affect the surface roughness of the machined surface whereby high cutting speed and low feed rate resulted in the better surface finish.
- v. Under various coolant-lubricant conditions, air blow produces higher cutting temperature as compared to other conditions.
- vi. The machined surface deteriorates due to the effect of metallurgical changes and surface quality during drilling at high cutting speed, feed rate and under various coolant conditions.

8. Acknowledgments

The authors wish to thank the Ministry of Higher Education of Malaysia and Research Management Center, UTM for their financial supports to this work through the Research University Grant (RUG) funding number Q.J130000.7124.02H43. Special gratitude is also extended to UTHM and TUAT, Japan and Technology and Mitsubishi Materials Corporation for providing the cutting tools.

9. References

- Boyer, R. R. (1996). An Overview on the Use of Titanium in the Aerospace Industry. *Material Science & Engineering*, Vol. 213, pp. 103-114, ISSN 0921-5093
- Brewer, W. D., Bird, R. K., & Wallace, T. A. (1998). Titanium alloys and Processing for High Speed Aircraft. *Materials Engineering & Science A*, Vol. 243, pp. 299-304, ISSN 0921-5093
- Brinksmeier, E. (1990). Prediction of Tool Fracture in Drilling. *Annals of CIRP*, Vol. 39, No. 1, pp. 97-100, ISSN 0007-8506
- Cantero, J. L., Tardio, M. M., Canteli, J.A., Marcos, M., & Miguelez, M. H., (2005). Dry drilling of alloy Ti-6Al-4V. *Int. J. Mach. Tools & Manuf.*, Vol. 45, pp. 1246-1255, ISSN 0890-6955
- Choudhury, S. K., & Raju, G. (2000). Investigation into Crater Wear in Drilling. *Int. J. Mach. Tools & Manuf.*, Vol. 40, pp. 887-898, ISSN 0890-6955
- Dolinsek, S., Sustarsic, B., & Kopac, J. (2001). Wear Mechanism of Cutting Tools in High Speed Cutting Process. *Wear*, Vol. 250, pp. 349-352, ISSN 0043-1648

- Ezugwu, E. O., & Lai, C. J. (1995). Failure Mode and Wear Mechanism of M35 High Speed Steel Drills When Machining Inconel 910. *J. Mater. Process. Technol.*, Vol. 49, pp. 295-312, ISSN 0924-0136
- Ezugwu, E. O., & Wang, Z. M. (1997). Titanium Alloys and Their Machinability – A Review. *J. Mater. Process. Technol.*, Vol. 68, pp. 262-274, ISSN 0924-0136
- Ezugwu, E. O., Wang, Z. M., & Machado, A. R. (2000). Wear of Carbides Tools When Machining Nickel And Titanium Base Alloys. *Tribology Transaction*, Vol. 43, No. 2, pp. 263-268, ISSN 0301-679X
- Ezugwu, E. O., Bonney, J., & Yamane, Y. (2003). An Overview of the Machinability of Aeroengine Alloys. *J. Mater. Process. Technol.*, Vol. 134, pp. 233-253, ISSN 0924-0136
- Field, D., & Kahles, J.M., (1964). The surface integrity of machined and high strength steels. *DMIC Report*, Vol. 210, pp. 54-77
- Fujise, K., & Ohtani, T. (1998). Machinability of Ti-6Al-4V Alloy in drilling with Small Drills. *Proc. 4th International Conference on Progress of Cutting and Grinding*. Urmqi and Torpan, China, October 1998
- Ginting, A., & Nouari, M., (2009). Surface integrity of dry machined titanium alloys. *Int. J. Mach. Tools & Manuf.*, Vol. 49, pp. 325-332, ISSN 0890-6955
- Harris, S. G., Doyle, E. D., Vlasveld, A. C., Audy, J., & Quick, D. (2003). A Study of the Wear Mechanism of $Ti_{1-x}Al_xN$ and $Ti_{1-x-y}Al_xCr_yN$ Coated High Speed Steel Twist Drill Under Dry Machining Conditions. *Wear*, Vol. 254, pp. 723-734, ISSN 0043-1648
- Hartung, P.D. & Kramer, B.M. (1982). Tool Wear in Machining Titanium. *Annals of CIRP*, Vol. 31, No. 1, pp. 75-80, ISSN 0007-8506
- Haron, C. H. C. (2001). Tool Life and Surface Integrity in Turning Titanium Alloy. *J. Mater. Process. Technol.*, Vol. 118, pp. 231-237, ISSN 0924-0136
- Haron, C. H. C, & Jawaid, A. (2005). The effect of machining on surface integrity of titanium alloy Ti-6% Al-4% V. *J. Mater. Process. Technol.*, Vol. 166, pp. 188-192, ISSN 0924-0136
- Jawaid, A., Sharif, S., & Koksai, S. (2000). Evaluation of Wear Mechanism of Coated Carbide Tools When Face Milling Titanium Alloy. *J. Mater. Process. Technol.*, Vol. 99, pp. 266-274, ISSN 0924-0136
- Jeelani, S., & Ramakrishnan, K., (1983). Subsurface plastic deformation in machining 6Al-2Sn-4Zr-2Mo titanium alloy. *Wear*, Vol. 85, pp. 121-130, ISSN 0043-1648
- Kaldor, S., & Lenz, E. (1980). Investigation in Tool Life of Twist Drill. *Annals of CIRP*, Vol. 52, pp. 30-35, ISSN 0007-8506
- Kanai, M., Fujii, S., Kanda, Y. (1978). Statistical Characteristics of Drill Wear and Drill Life for the Standardized Performance Tests. *Annals of CIRP*, Vol. 27, No. 1, pp. 61-66, ISSN 0007-8506
- Kramer, B. M. (1987). On Tool Materials for High Speed Machining. *ASME Journal of Engineering for Industry*, Vol. 109, pp. 87-91, ISSN 0022-1817
- Li, R., & Shih, A. J., (2007). Spiral point drill temperature and stress in high-throughput drilling of titanium. *Int. J. Mach. Tools & Manuf.*, Vol. 47, pp. 2005-2017, ISSN 0890-6955
- Liao, Y. S., Chen, Y. C., & Lin, H. M., (2007). Feasibility study of the ultrasonic vibration assisted drilling of Inconel superalloy. *Int. J. Mach. Tools & Manuf.*, Vol. 47, pp. 1988-1996, ISSN 0890-6955

- Linberg, R. A. (1990). *Processes and Materials of Manufacture*, 4th Edition, Prentice-Hall Inc., ISBN 978-81-203-0663-9, New Jersey, USA
- Lopez, L. N., Perez, J., Llorente, J. I., & Sanchez, J. A. (2000). Advanced Cutting Conditions For the Milling of Aeronautical Alloys. *J. Mater. Process. Technol.*, Vol. 100, pp. 1-11, ISSN 0924-0136
- Mantle, A. L., Aspinwall, D. K., & Wollenhofer, O. (1995). Twist Drill of Gamma Titanium Aluminide Intermetallics. *Proc. 12th Conference of the Irish Manuf. Committee*, United Kingdom, May 1995
- Okamura, K., Sasahara, H., Segawa, T., Tsutsumi, M., (2006). Low-frequency vibration drilling of titanium alloy. *International Journal of Japan Society of Mechanical Engineers, Series C*, Vol. 49, pp. 76-82, ISSN 1347-538X
- Ozcelik, B., & Bagci, E. (2006). Experimental and numerical studies on the determination of twist drill temperature in dry drilling: A new approach. *Materials and Design*, Vol 27, pp. 920-927, ISSN 0261-3069
- Pujana, J., Rivero, A., Celaya, A., & Lopez, L.N. (2009). An analysis of ultrasonic-assisted drilling of Ti-6Al-4V. *Int. J. Mach. Tools & Manuf.*, Vol. 49, pp. 500-508, ISSN 0890-6955
- Rahim, E. A. (2005), Performance evaluation of uncoated and coated carbide tools when drilling titanium alloy, *Master Thesis*, Universiti Teknologi Malaysia
- Rahim, E. A. , & Sharif, S. (2006). Investigation on Tool Life and Surface Integrity when Drilling Ti- 6Al-4V and Ti-5Al-4V-Mo/Fe. *International Journal of Japan Society of Mechanical Engineer, Series C*, Vol. 49, No. 2, pp. 340-345, , ISSN 1347-538X
- Rahim, E. A. , Kamdani, K., & Sharif, S. (2008). Performance Evaluation of Uncoated Carbide Tool in High Speed Drilling of Ti6Al4V. *Journal of Advanced Mechanical Design, System and Manufacturing*, Vol. 2, No. 4, pp. 522-531, ISSN 1881-3054
- Rahim, E. A., & Sharif, S. (2009). Evaluation of tool wear mechanism of TiAlN coated tools when drilling Ti-6Al-4V. *International Journal of Manufacturing Technology and Management*, Vol. 17, No. 4, pp. 327-336, ISSN 1741-5195
- Rahim, E. A., & Sasahara, H. (2010a). The Effect of MQL Fluids on the Drilling Performance of Nickel-Based Superalloy. *4th International Conference on High Performance Cutting*, Gifu, Japan, October 2010
- Rahim, E. A., & Sasahara, H. (2010b). Investigation of Tool Wear and Surface Integrity on MQL Machining of Ti-6Al-4V using Biodegradable Oil. *Proceedings of the Institution of Mechanical Engineers, Part B, Journal of Engineering Manufacture*. Accepted to be published
- Rahim, E. A. & Sasahara, H. (2011) A Study of the Effect of Palm Oil as MQL Lubricant on High Speed Drilling of Titanium Alloys. *Tribology International*, Vol. 44, pp. 309-317, ISSN 0301-679X
- Sakurai, K., Adichi, K., Ogawa, K., & Niba, R., (1992). Drilling of Ti6Al4V. *Journal of Japan Institute of Light Metals*, Vol. 42, No. 7, pp. 389-394, ISSN 1880-8018
- Sakurai, K., Adichi, K., Kamekawa, T., Ogawa, K., & Hanasaki, S., (1996). Intermittently Decelerated Feed Drilling of Ti6Al4V Alloy. *Journal of Japan Institute of Light Metals*, Vol. 46, No. 3, pp. 138-143, ISSN 1880-8018
- Schneider, G. (2001). Applied Cutting Tool Engineering. *Tooling and Production*, Vol. 66, No. 12, pp. 37-45, ISSN 0040-9243

- Sharif, S. & Rahim, E. A. (2007). Performance of Coated and Uncoated Carbide Tools when Drilling of Titanium Alloy – Ti-6Al4V. *J. Mater. Process. Technol.*, Vol. 185, pp. 72-76, ISSN 0924-0136
- Sun, J., & Guo, Y.B., (2009). A comprehensive experimental study on surface integrity by end milling Ti-6Al-4V. *J. Mater. Process. Technol.*, Vol. 209, pp. 4036-4042, ISSN 0924-0136
- Tetsutaro, H., & Zhao, H. (1989). Study of a High Performance Drill Geometry. *Annals of CIRP*, Vol. 38, No. 1, pp. 87-90, ISSN 0007-8506
- Tonshoff, H. K., Spintig, W., & Konig, W. (1994). Machining of Holes Developments in Drilling Technology. *Annals of CIRP*, Vol. 43, No. 2, pp. 551-561, ISSN 0007-8506
- Vaughn, R. L. (1966). Modern Metals Machining Technology. *ASME Journal of Engineering for Industry*, pp. 65-71, ISSN 0022-1817
- Velasquez, J.D.P., Tidu, A., Bolle, B., Chevrier, P., & Funderberger, J.J. (2010). Sub-surface and surface analysis of high speed machined Ti-6Al-4V alloy. *Materials Science & Engineering A*, Vol. 527, pp. 2572-2578, ISSN 0921-5093
- Wen, C. C., & Xiao, D. L. (2000). Study On the Various Coated Twist Drills For Stainless Steels Drilling. *J. Mater. Process. Technol.*, Vol. 99, pp. 226-230, ISSN 0924-0136
- Zeilmann, R.P., & Weingaertner, W.L., (2006). Analysis of temperature during drilling of Ti6Al4V with minimal quantity of lubrication. *J. Mater. Process. Technol.*, Vol. 179, pp. 124-127, ISSN 0924-0136

IntechOpen

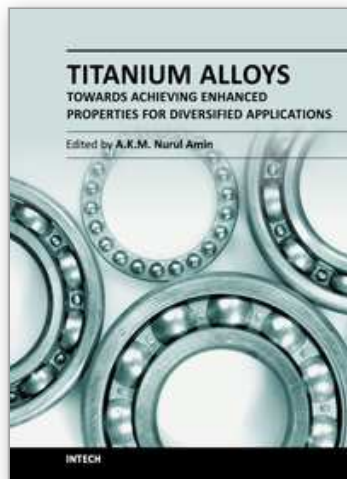

Titanium Alloys - Towards Achieving Enhanced Properties for Diversified Applications

Edited by Dr. A.K.M. Nurul Amin

ISBN 978-953-51-0354-7

Hard cover, 228 pages

Publisher InTech

Published online 16, March, 2012

Published in print edition March, 2012

The first section of the book includes the following topics: fusion-based additive manufacturing (AM) processes of titanium alloys and their numerical modelling, mechanism of β -case formation mechanism during investment casting of titanium, genesis of gas-containing defects in cast titanium products. Second section includes topics on behavior of the ($\alpha + \beta$) titanium alloys under extreme pressure and temperature conditions, hot and super plasticity of titanium ($\alpha + \beta$) alloys and some machinability aspects of titanium alloys in drilling. Finally, the third section includes topics on different surface treatment methods including nanotube-anodic layer formation on two phase titanium alloys in phosphoric acid for biomedical applications, chemico-thermal treatment of titanium alloys applying nitriding process for improving corrosion resistance of titanium alloys.

How to reference

In order to correctly reference this scholarly work, feel free to copy and paste the following:

Safian Sharif, Erween Abd Rahim and Hiroyuki Sasahara (2012). Machinability of Titanium Alloys in Drilling, Titanium Alloys - Towards Achieving Enhanced Properties for Diversified Applications, Dr. A.K.M. Nurul Amin (Ed.), ISBN: 978-953-51-0354-7, InTech, Available from: <http://www.intechopen.com/books/titanium-alloys-towards-achieving-enhanced-properties-for-diversified-applications/drilling-of-titanium-alloys>

INTECH
open science | open minds

InTech Europe

University Campus STeP Ri
Slavka Krautzeka 83/A
51000 Rijeka, Croatia
Phone: +385 (51) 770 447
Fax: +385 (51) 686 166
www.intechopen.com

InTech China

Unit 405, Office Block, Hotel Equatorial Shanghai
No.65, Yan An Road (West), Shanghai, 200040, China
中国上海市延安西路65号上海国际贵都大饭店办公楼405单元
Phone: +86-21-62489820
Fax: +86-21-62489821

© 2012 The Author(s). Licensee IntechOpen. This is an open access article distributed under the terms of the [Creative Commons Attribution 3.0 License](#), which permits unrestricted use, distribution, and reproduction in any medium, provided the original work is properly cited.

IntechOpen

IntechOpen