

We are IntechOpen, the world's leading publisher of Open Access books Built by scientists, for scientists

4,800

Open access books available

122,000

International authors and editors

135M

Downloads

Our authors are among the

154

Countries delivered to

TOP 1%

most cited scientists

12.2%

Contributors from top 500 universities



WEB OF SCIENCE™

Selection of our books indexed in the Book Citation Index
in Web of Science™ Core Collection (BKCI)

Interested in publishing with us?
Contact book.department@intechopen.com

Numbers displayed above are based on latest data collected.

For more information visit www.intechopen.com



Fossil Fuel Power Plant Simulators for Operator Training

José Tavira-Mondragón, Guillermo Romero-Jiménez
and Luis Jiménez-Fraustro
*Electric Research Institute
Mexico*

1. Introduction

Before the 1970's the use of simulators to train the operation personnel of the power plants was not widely diffused. In these times, the operators acquire their skills by working head to head with some experienced operators in the actual plant, so they learned all the knowledge of their mentor, this means, all the virtues and defects of the experienced people. As expected, the trainees also receive the classic classroom lessons with the aim to complement their training. The training finished when the manager of the plant decided the trainee was ready to operate and control the plant. In the majority of the cases, the main problem of this kind of training was that the operator just learned the typical actions related with the start-up of the equipment and operation of the plant in nominal conditions. Therefore, operators had not been trained in abnormal situations, where they needed to act rapidly to keep the power plant in safety conditions. Naturally any operative mistake could lead to a unit trip, equipment damage or risk to staff with all the economic losses related with this type of problems. During the 1970's, in the United States, the nuclear power industry made the commitment of including simulators as a part of the training programs of their nuclear power plant operators, gradually the use of simulators in the nuclear power industry gained worldwide acceptance. In 1979 a major accident occurred at Three Mile Island (TMI) Unit 2 in Middletown, Pennsylvania resulted in a critical assessment of the preparedness of operations staff to respond to the accident. It is commonly believed that the incident at TMI would not have occurred if the operators had been properly trained. This accident prompted a complete re-evaluation of the nuclear industry's operator training programmes (Perkins, 1985). Events like this reinforced the growth of the rising industry of simulators and that extended its application to the fossil fuel power plants too. Specifically in this segment, the Electric Power Research Institute [EPRI] (1993) carried over a cost-benefit analysis of simulators used at fossil fuel power plants, where the identified benefits were: availability savings, thermal performance savings, component life savings, and environmental compliance savings. Additionally EPRI reported that approximately 20% of forced plant outages were direct result of operator or maintenance error. Therefore, reducing operator controllable outages through training on a simulator can significantly reduce operating costs. Additional quotes about operators errors (Serious Games LLC, 2006), establishes that "One manufacturing analyst estimated, human error leading to abnormal situations costs the UK process industry \$1.4 billion a year" and "In the last 25 years,

the largest 100 accidents in the hydrocarbon-chemical processing industry cost \$7.52 billion in losses; operator error accounted for 21% of these events at an average of \$75 million per loss”.

The modern distributed control systems of the power plants provide to the operator with the elements to get a power generation stable, safe and reliable, but as a consequence, there is a reduction of the operator's confidence to carry out unusual manoeuvres, e.g. a start-up in manual mode or the requested actions after a feed water pump trip. Training simulators help operators to practice this type of manoeuvres. The main advantage of a simulator as a training tool is that the operator does not need to touch the actual unit to learn to operate it in a broad range of possible scenarios. These scenarios include normal operations like unit start-up from cold iron to full load and shutdown. Also can be defined scenarios for malfunctions in which the trainee practice the suitable operative actions when in the simulated unit there are events like: trips of pumps and turbine, tube ruptures, and “faulty” instrumentation. In other words, the operators use the simulator to practice their normal operation procedures and to practice infrequent evolutions and faulted conditions. Therefore, one of the most important parts of the training programmes of power plant operators is carried out through simulators, a big number of these simulators are of the type called full-scope, these simulators incorporate detailed modelling of those systems of the referenced plant with which the operator interfaces in the actual control room environment. Usually, replica control room operating consoles are included (International Atomic Energy Agency [IAEA], 2004). In these simulators, the responses of the simulated unit are identical in time and indication to the responses received in the actual plant control room under similar conditions. A significant portion of the expense encountered with this type of simulators is the high fidelity simulation software that must be developed to drive it. The completeness of training using a full-scope simulator is obviously much greater than that available on other simulator types since the operator is performing in an environment that is identical to that of the control room. Experienced operators can be effectively retrained on these simulators because the variety of conditions, malfunctions, and situations offered do not cause the operator to become bored with the training or to learn it by rote (Instrument Society of America [ISA], 1993). Therefore, full-scope simulators are recognized worldwide as the only realistic method to provide real-time and hand-on training of operators. Also the simulators can be utilized to validate the normal operating procedures, to conduct engineering studies and to train plant technical supporting personnel.

However, the expense of developing this kind of simulators, the necessity of training a bigger number of the operation staff and the search of better training has driven the development of different training tools, for instance, there are part-task simulators, where the users are only trained in a particular system of the power plant (e.g. feed-water system, steam turbine, etc.). There are also compact simulators, where the users can practice the majority of the main operation actions required in a power plant, but the operation interfaces are of a generic type and not necessarily are similar to the ones the operators utilize in their actual power plant. In many cases, the part-task and compact simulators are portables, so they are transported to the power plants, in this way, the operators can practice onsite, these simulators can be utilized with the assistance of an instructor, in a free-hands context, or with the guidance of an expert system. In spite of the shortcomings of these simulators, there are some clearly identified benefits of using a variety of training simulators, which are: the ability to train on malfunctions, transients and accidents; the reduction of risk to plant equipment and personnel; the ability to train personnel on actual

plant events; a broader range of personnel receiving effective training; and individualized instruction or self-training being performed effectively on simulation devices designed with these capabilities in mind. The use of simulators has proven through the years to be one of the most effective and confident ways by training power plant operators. Using simulators, operators can learn how to operate the plant more efficiently, lowering the heart rate and reducing the power required by plant auxiliary equipment (Hoffman, 1995).

The main features and types of training simulators, the importance of a well structured training programme to maximize the benefits of a simulator and the two most important paradigms for the mathematical modelling are discussed in the following sections.

2. Training simulators

According to The Free Dictionary (thefreedictionary, 2008), a simulator is defined as “any device or system that simulates specific conditions or the characteristics of a real process or machine for the purposes of research or operator training”. In the context of training of power plant operators, a simulator is a system composed of a Human Machine Interface (HMI) which replicates the operation consoles of the actual plant and a computer that executes mathematical models, which “replicate” unit performance. These simulators are based on the mathematical modelling of dynamic systems and their expected responses have a real-time functioning. Usually the training sessions are guided by an instructor which establishes the initial condition, starts the simulation, and supervises the actions of the trainees. This concept is shown in a simplified way in Figure 1.

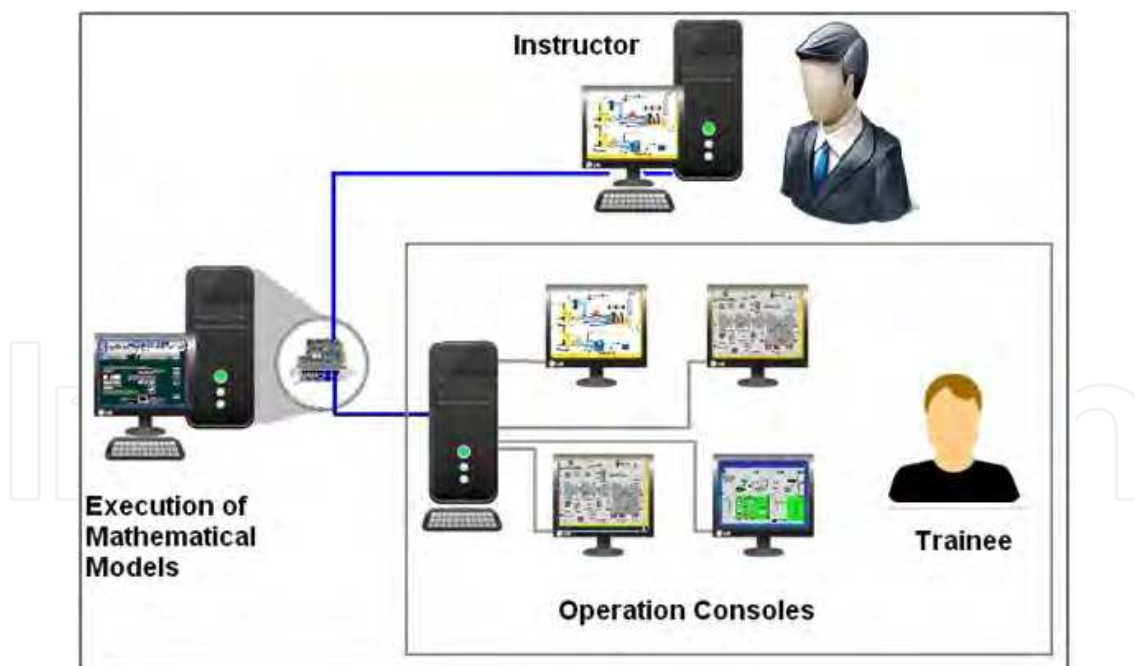

Fig. 1. Schematic representation of a training simulator.

2.1 Simulators with different scopes

According to the training objectives and the available hardware, there are different types of simulators; a brief review of them is done in the next sections.

2.1.1 Full-scope

A full-scope simulator can be defined as an exact duplicate of a power plant control room, containing duplicates of all actual controls, instruments, panels, and indicators. The unit responses simulated on this apparatus are identical in time and indication to the responses received in the actual plant control room under similar conditions. A significant portion of the expense encountered with this type of simulator is the high fidelity simulation software that must be developed to drive it (ISA, 1993). Due to the HMI of the trainee must be a “copy” of the control room of the power plant, it was ordinary that a simulator had the same control boards of the actual unit, which naturally involved a big expense for its construction. Figure 2 shows two control board simulators, for a 300 MW fossil fuel power plant (left side) and for a 350 MW fossil fuel power plant (right side).

On the other hand, in recent years the power increase of computers, their reliability and variety of graphical interfaces (Yamamori et al., 2000), added to the continued search to cut costs caused a new technological trend. In this trend, the power plants have replaced their former control boards with a local area network of Personal Computers (PC) with graphical user interfaces. In this way, new or modernized power plants have a HMI, where all the supervising and operation actions are carried out through interactive processes diagrams.



Fig. 2. Control board simulators.

Naturally, the operators of these plants need a suitable training because they face a complete change in their operation paradigm, and because of this, the training simulators also require a HMI as the one in the actual plant, an example of these simulators is in Figure 3.

The technological revolution affected the hardware and software components of the simulator, for instance, Zabre and Román (2008) describe the evolution on hardware, operating systems and software for the power plant simulators developed by the Electric Research Institute of Mexico in the last 30 years. Table 1 shows the main features of the hardware-software platforms for different simulators. In fact, this revision is focused over the Mexican market but it is very representative of the world scale evolution of the hardware-software platforms for simulators. The typical architecture of this type of simulators is given in section 4.



Fig. 3. Simulator with interactive process diagrams.

Item	1980s	Latest 1990s	Nowadays
Main Computer	Gould/Encore	Workstation	Local Area Network of Personal Computers
HMI	Control Boards	Control Boards and Interactive Process Diagrams	Interactive Process Diagrams
Operative System	MPX-32	Unix TRU64	Windows XP/Windows 7
Software	Fortran compiler	Fortran and C compilers Oracle DB GE DataViews	Fortran and C compilers MS Access/SQL Server MS Visual Studio Adobe Flash
Examples of simulators	300 MW fossil fuel (no DCS) power plant 350 MW fossil fuel (with DCS) power plant	Upgrade of 300 MW fossil fuel Update of 350 MW fossil fuel	350 MW coal fired power plant 450 MW combined cycle power plant

Table 1. Evolution of hardware and software platforms.

Typical operations to carry out by the trainees in a simulator are:

- Unit start-up from cold iron or hot standby up to nominal power.
- Boiler pressurization.
- Turning, acceleration and synchronization of the turbine-generator group.
- Unit shutdown.
- Any operative action feasible in the actual plant.

The simulator also can reproduce abnormal or emergency situations due to a deficient operation of the trainee or due to a malfunction inserted by the instructor. In the last case, during the specification of the simulator must be defined a malfunctions group. These malfunctions are of two types: binary and analogue. The first group contains malfunctions like: pump trips, fail position of valves, etc. The analogue malfunctions have a degree of severity (usually normalized from 0 to 100%) and their severity can be selected by the instructor. Examples are tubes rupture of steam lines and fouling factor of heat exchangers.

2.1.2 Part-task simulators

A part-task simulator is focused only on specific plant systems. These systems are represented with features of a full-scope simulator, in this way, detailed mathematical modelling of the referenced plant systems is included and just a part of the actual control room is duplicated with all key instrumentation, controls and alarm signals. The systems not included in the HMI are simulated with a reduced scope or no simulated and considered as always "on service", just to satisfy the interactions of the main systems. For instance, Figure 4 shows a part-task simulator to train operators in turning and acceleration of the steam turbine (Burgos, 1993). This simulator includes the portion of the control board corresponding to the steam valves (throttling, governing, stop and intercept) and the related instrumentation and control.



Fig. 4. Part task simulator

The systems connected to the steam turbine (including the thermal model for rotor and casings), lubrication oil, control oil and required controls are simulated in a full-scope context, but other systems like main steam, feed water and main condenser are simulated with a reduced scope. Therefore these simulators are beneficial to improve the knowledge and provide training in particular areas of the power plant. Tavira-Mondragón et al. (2006) describes a part-task simulator for five subsystems of a fossil fuel power plant with a HMI based on interactive process diagrams. The systems considered are: electric network, auxiliary services, boiler pressurization, turning turbine and power increasing from minimum up to nominal power. This simulator is portable to be transported to the power plants.

A different approach for a simulator is the proposed by Pevneva et al. (2007), these authors present a unified training simulator for the personnel of the boiler-turbine and chemical departments with the purpose of perfecting interaction skills between these areas.

2.1.3 Compact simulators

Compact simulators are frequently generics, this means they reproduce the behaviour of a specific power plant, but the rated power and the HMI for the trainee no necessarily are the same of the actual plant. However, they include mathematical modelling of wide scope which allows simulating plant conditions from cold iron up to nominal power. In this way they are mainly utilized to train novice operators and field personnel. Fray and Divakaruni (1995) claim this kind of simulators can be parameterized with unit-specific design and operating data for power units of specific generation and inclusive it is possible to include the emulation of an exact replica of the plant control system. This type of modifications necessarily increment the initial cost of the simulator and such modifications must be done by very specialized personnel.

Currently, with the power of modern computers, a complete power plant simulator can be installed in a laptop and easily transported, the main problem is the use of the simulator by the trainee because its interface is reduced, in the best-case scenario to a equipment with three displays (Figure 5), and with the number of actions required to operate the simulated system, a suitable training can be a complex problem without a effective method to do it.

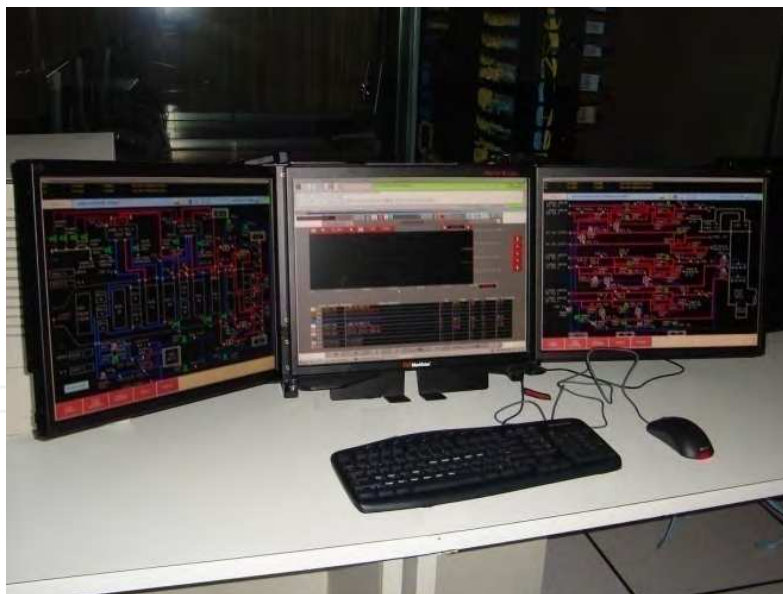

Fig. 5. Compact simulator

2.1.4 Classroom simulators

These simulators usually include detailed mathematical modelling and they can be divided in two groups: graphical and multi-user. Graphical simulators are based on a representation of the HMI in graphical form (display units or virtual images). These simulators provide a low-cost alternative to other simulators requiring the use of control

room hardware (IAEA, 1998); therefore they have been used preferably in the nuclear power industry due to the great number of control boards of these plants. On the other hand, multi-user simulators are installed in a local area network and they are used as a complement of the training courses for operators of fossil power plants (Tavira-Mondragón et al., 2005; Romero-Jiménez et al., 2008). In these simulators, the instructor has a console where he simultaneously directs the simulation sessions for each one of the trainees. With his console, the instructor establishes the same or different training exercises for each one of the students and supervises them in an individual way from the same interface. Each one of the trainees has his own console to operate the simulated power plant in an independent way of the other students.

2.1.5 Virtual simulators

With the increase in processing capacity, computational speed, advances in computer technology and the sophistication in modelling, it is becoming more feasible to develop systems based on Virtual Reality (VR) or Augmented Reality (AR). These systems implement hardware interfaces which deliver a more stimulating experience to the trainee, via the experimentation of “realistic” sensations. In an available dynamic simulator can be implemented a three-dimensional visor in order to train maintenance people on local operations and to complement actual training programmes with three-dimensional view of equipment like: turbines, boilers, electric generator, etc. With these systems, trainees practice the operation of the process, and at the same time, they get a better understanding of the physical and chemical phenomena occurred and obtain detailed knowledge about the equipment. Martínez-Ramírez et al. (2011) present a prototype of a VR training system for a thermal power plant.

2.1.6 Web simulators

According to the simulators architectures previously discussed, the simulators are installed in a training centre or on site if the simulator is easily portable. In the case of the simulators where more than a PC is involved, the computers are connected in a local area network. Therefore, the communication between the interactive processes diagrams and the mathematical models is based on a proprietary protocol and implemented over TCP/IP with the aim to link two points within a local network. Such diagrams are part of a conventional Windows application, which can only be executed on a computer with the environment provided by the operating system and interconnected to the same network, so it cannot be transmitted through the Internet and take advantage of modern information technologies like cloud computing.

Cloud computing is the delivery of computing as a service rather than a product, whereby shared resources, software and information are provided to computers and other devices over a network (typically the Internet). Cloud computing provides computation, software, data access, and storage services that do not require end-user knowledge of the physical location and configuration of the system that delivers the services. The concept of cloud computing fills a perpetual need of information technologies: a way to increase capacity or add capabilities on the fly without investing in new infrastructure, training new personnel, or licensing new software. Cloud computing encompasses any subscription-based or pay-

per-use service that, in real-time over the Internet, extends information technologies existing capabilities. Cloud computing providers deliver applications via the internet, which are accessed from a web browser, while the business software and data are stored on servers at a remote location (Wikipedia, 2011a).

In the current transition process to new computational paradigms, where Internet plays a important role, the use of modern techniques for the development of software applications is a key strategy to guide these technologies, and training simulators require to adapt their platforms to support suitable graphical interfaces for the final user and implement the Internet communication mechanisms called web services. As a result of this process, it is obtained a web user interface which allows interacting with a simulator from a remote location via a HMI with similar features to the ones available in the simulators of the training centres. In such way, the simulator is available to any computer with an internet connection and a web browser with the plugins required for the application. Figure 6 shows the services provided by cloud computing and its comparison with the services required for a full-scope simulator.

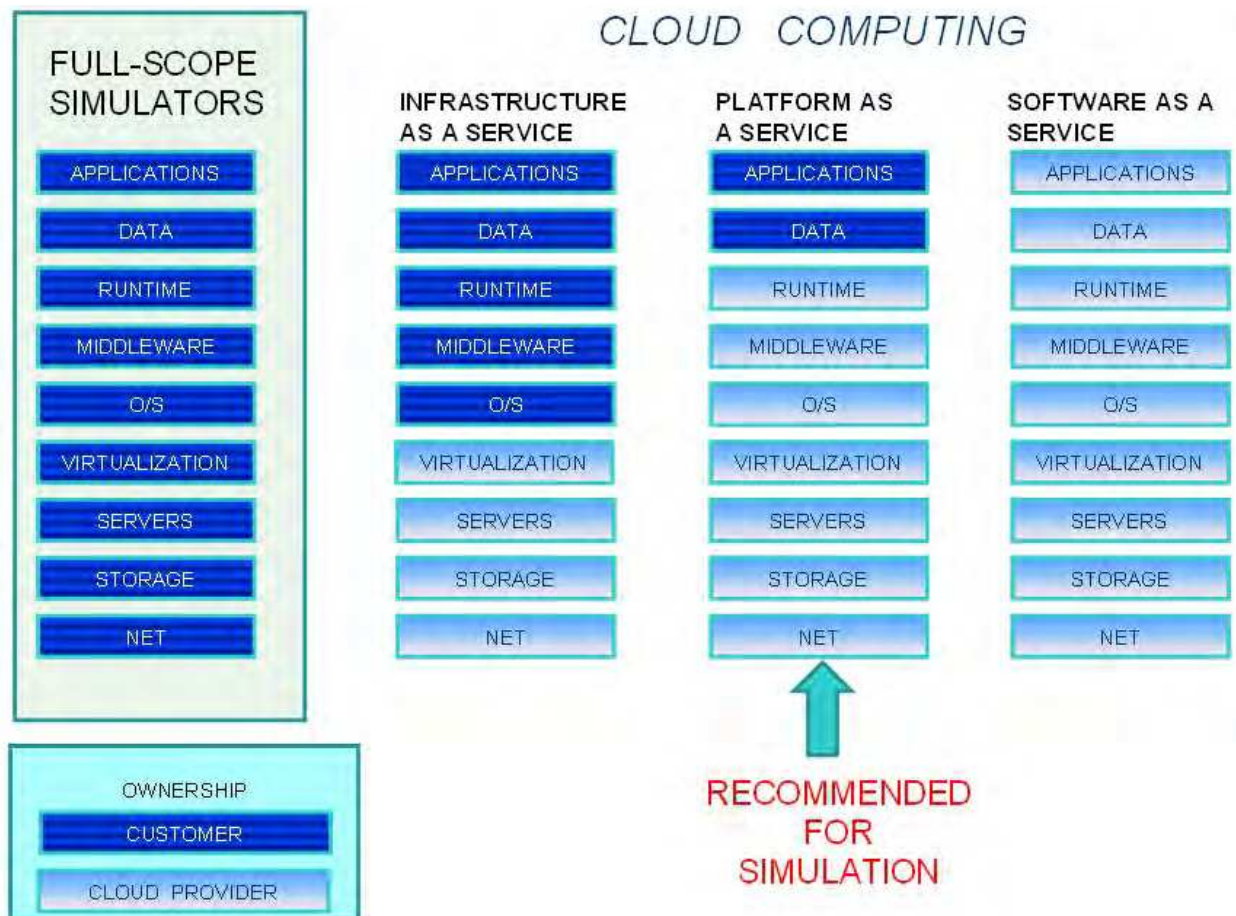

Fig. 6. Cloud computing services.

2.2 Instructor role and training programmes

As it was mentioned at the beginning of the chapter, the instructor of a training session is in charge of directing and supervising to the trainees. The role of the instructor depends

of the simulator type and the trainees' knowledge, in this way, the instructor needs to balance the complexity of training practices with the needs of the trainees and provide them of the additional information and explanations to get a complete understanding of the phenomena involved. The instructor console is the instructor interface to conduct the training session; this interface is usually a graphic display with pull-down menus and icons for an easy access to the functions required. Figure 7 shows a typical instructor console interface.



Fig. 7. Main interface of the instructor console

The main functions of the instructor console are as follow:

- Control Menu. It has the functions that allow the instructor to manage the simulation session. The available options are:
 - Run/Freeze. The instructor starts or freezes a dynamic simulation. The mathematical models of the control and process respond to the actions of the trainee in a comparable way as it occurs in the actual plant.
 - Record and Playback. A continuous recording of trainee actions for later replay which can be repeated automatically
 - Simulation speed. In its default mode, the simulator is executed in real-time, but the instructor can execute the simulator faster or slower than real-time. This option is especially important when the instructor wants the trainees analyze a fast transient, allowing him to simulate it slower. On the other hand, a slow thermal process like turbine iron-heating can be simulated faster.
 - Automatic Exercises. The instructor can create automatic training exercises, each one of them can include: initial conditions, malfunctions, remote actions, and a time sequence. The exercises are stored for their subsequent use.
- Initial Conditions. They allow establishing the state of the simulated process at the beginning of the session and creating new ones. The options are:
 - Selecting an initial condition (snapshot) to start the simulation session, for instance: *Cold start, Ready to roll turbine, Full load.*
 - Recording a new initial condition or erasing an old initial condition;
 - Specifying the time interval of automatic snapshots.
- Instruction Functions Menu. They contain functions which alter the simulated process.

- The option of Malfunctions is used to introduce/remove an equipment malfunction at any time during the simulation session. Examples of malfunctions are: pump trips, heat exchanger tubes rupture, and control valve obstructions. All the malfunctions are grouped in systems and subsystems for easy location. For the binary malfunctions, the instructor has the option of defining its time delay and its duration. For analog malfunctions, besides the former time parameters, the instructor can also define their intensity. Additionally it is possible to select any instrument of the HMI and make it faulty, so it shows an unreliable indication to the trainee.
- The instructor has the option of Remote Functions to simulate the operative actions not related with automated equipment. These operative actions are associated with the local actions performed in the actual plant by an auxiliary operator. Examples are: to open/close valves and to turn on/off pumps or fans. Similarly to the malfunctions, they are grouped in systems and subsystems.
- The option of External Parameters allows the instructor to modify the external conditions to the process. These conditions are: atmospheric pressure, room temperature, voltage and frequency of the external electric system and fuel composition.
- Tracking and Miscellaneous Menus. They contain additional functions to help the instructor to get information of the simulator behaviour and to manage the access to the simulator.

A panoramic view of the instruction room with three instructors guiding the training sessions in three different simulators is shown in Figure 8.



Fig. 8. Instruction room

With the aim of providing to the operation personnel of the knowledge and abilities to operate in a safe and reliable way a power plant, the training programmes usually include: classroom lessons, practice in the simulator and “on the job experiences”. The design and execution of a successful training programme involves a variety of people coordinating their efforts to achieve the desired results.

The ADDIE model is a suggested methodology to develop the training programmes for the power plant operators (EPRI, 2005). The acronym ADDIE signifies the phases of the training development process: Analysis, Design, Development, Implementation and Evaluation. A brief description of these phases is as follow:

- The Analysis phase is the base of the instructional design model. In this phase the personnel in charge of the programme identifies the learning problem, establishes the training objectives, and the trainee necessities. This phase may include specific research techniques such as trainee analysis and task analysis. During the trainee analysis, the training specialist examines the current knowledge and skills of trainees and determines what they already know and their abilities. The training specialist uses this information to create a course that focuses on trainees needs. On the other hand, in the task analysis a training specialist is able to create a competency map for trainees. The results of this phase often include educational goals and a list of tasks.
- The Design phase uses the results of the analysis phase to plan a strategy for the development of the training. During this phase, the training specialist outlines a systematic process to achieve the educational goals previously identified, he specifies too, the organization of the course, topics to be covered (and the delivery format), activities, exercises and evaluation of the trainees. In the phase are defined the required practice in simulator and its type, for instance, to achieve objectives related with familiarization of the HMI, a classroom simulator is a good option, and to reach objectives of developing abilities for a safer operation when the trainee faces a malfunction, a full-scope simulator is the best choice. So the specification of the required features of the simulator becomes a key point of this stage.
- The Development phase is the creation of the content and learning materials based on the design stage. Therefore, the end result are the media and its content, this includes written lessons, software (e.g. computer-based instruction) and hardware-software (e.g., simulators), all of this with the aim of getting the training objectives. In the case of a fossil fuel power plant simulator is a common practice to acquire it instead of developing it, due to the complexity and the time required to build a simulator.
- The Implementation phase is the training impartation, whether based in the classroom, simulator or in the job. From an ideal point of view, the instruction would be efficient and effective, but it can be one of the hardest parts of the system because in this phase many of the failures and virtues of the previous stages are manifested, besides the trainers faculties to transmit the required knowledge to trainees is a very important element of the learning process. However, this phase must promote understanding of the material by trainees, and the reaching of the programme objectives.
- The Evaluation phase measures how well the training objectives were achieved. This evaluation is carried out in each one of the previous stages (Formative) to improve the training process before the implementation of the final version of the programme. There is also an evaluation performed after the final version is implemented (Summative), which gives an overall assessment of the training process, this serves to determine if the programme requires notorious changes or just a fine-tune, in this evaluation the feedback of trainees is very important.

The interaction of the different phases of the ADDIE is depicted in Figure 9. The main benefit in using a structured phased approach is that to the end of the process, the training objectives will be more likely achieved.

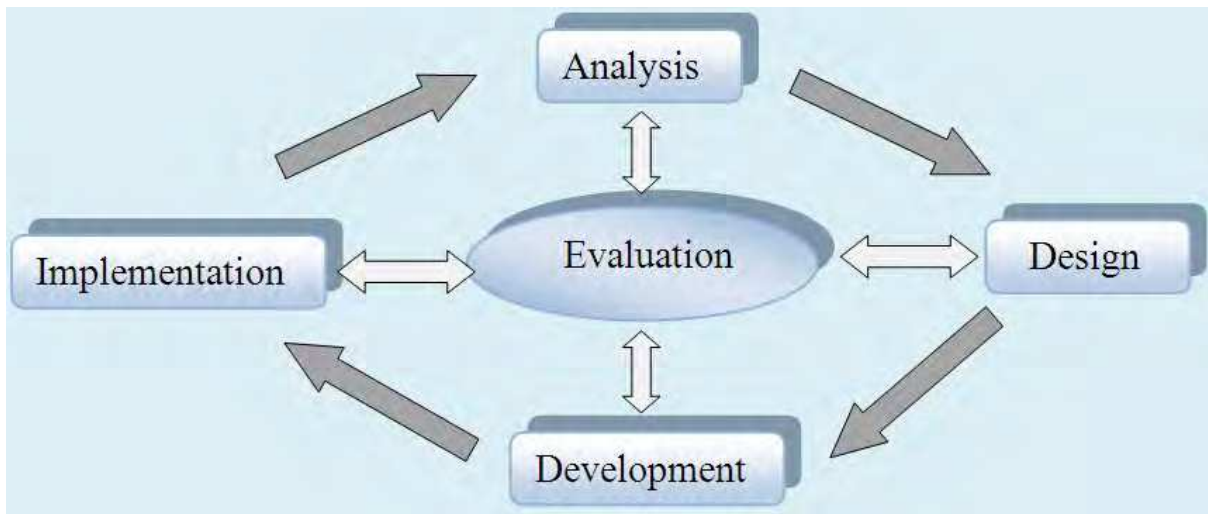

Fig. 9. ADDIES phases

2.3 Simulation and the plant lifecycle

The use of simulation throughout the plant life cycle, from the design until training and operation stages, has the potential of providing significant benefits. The cumulative effect of cost savings and improved operating rate can be substantial and typically return the initial simulation investment within the first year of operation. It will also continue to contribute to profitability based on better operation practices. Ahmad et al. (2010) present a case study where the use of an operator training simulator and the incorporation of advanced process control reduce the cost of a project in 49 Millions USD. The application of dynamic simulation throughout the plant lifecycle can provide the following benefits:

- Identify process and control constraints at the conceptual design phase.
- Begin start-up of a new or modernized unit sooner.
- Train operators on safe operation procedures.
- Transfer best practices to new operators with hands-on practice.
- Avoid or minimize incidents and recover faster from abnormal situations.
- Satisfy government regulations.
- Provide simulation applications to improve operation and control
- Safety training and crisis handling.
- Reduce equipment trips.
- Improve process know-how.
- Increase process controllability and reliability.
- Expand component life and reduce the risk of equipment damage
- Start-up faster and reduce heat rate.
- Operate closer to environmental limits.
- Better operation during start-ups, power increasing and shutdowns.
- Better response to plant transients, abnormal situations and emergencies.
- Verify the operation in design conditions.
- Stimulate the teamwork and communication.
- Reduced costs through evaluation and process optimization
- Improve plant safety

Besides the referred documents of the ISA, IAEA and EPRI, additional information about simulators and training programmes can be founded in EPRI (1998) and IAEA (1996, 2003). The documents published by IAEA deal about the training of operators of nuclear power plants but many of the key concepts are applicable to the fossil industry.

3. Application of expert systems to training simulators

Expert Systems (ES) are computer programs that incorporate a large amount of knowledge in a very specific field and are used to give advice or solve problems. The use of ES became a viable solution to real problems since the 1980's, since then, the use of ES has proliferating to many technological sectors, as it is demonstrated in the review of Liao (2005). Olmstadt (2000) presents a definition of ES which synthesizes many of the different definitions available in the literature, this is: ES use human expertise (the result of deliberate practice on standard tasks over many years) to answer questions, pose questions, solve problems, and assist humans in solving problems. They do so by using inferences similar to those a human expert would make, to produce a justified, sound response in a brief period of time. When questioned, they should be able to produce the rules and processes that show how they arrived at the solution. The main parts of the ES are:

- Knowledge base. It contains the knowledge of the facts and experiences of experts in a particular domain, i.e., it contains general knowledge about the expert domain.
- Inference engine. It is responsible of modelling the process of human reasoning. This engine works with the information contained in the knowledge base.
- User interface. This represents the method through the ES interacts with the user. This may require designing the interface using menus, dialog boxes, forms, graphics, etc.

According to the capabilities of ES, their use in training power plant simulators has been explored as intent of minimizing the instructor role. Seifi and Seifi (2002) developed their own intelligent tutoring system for a fossil fuel power plant simulator, while Arjona et al. (2003) utilize CLIPS as foundation for their tutoring system of a part-task simulator for a steam turbine. The C Language Integrated Production System (CLIPS) is probably the most widely used expert system tool because it is fast, efficient and free (Wikipedia, 2011b). CLIPS is an inference engine initially developed to facilitate the representation of knowledge to model human expertise, it provides a cohesive tool for handling a wide variety of knowledge with support for three different programming paradigms: rule-based, object-oriented and procedural. Rule-based programming allows knowledge to be represented as heuristics, or "rules of thumb", which specify a set of actions to be performed for a given situation. Object-oriented programming allows complex systems to be modelled as modular components, which can be easily reused to model other systems or to create new components. In the procedural approach, CLIPS can be called from a procedural language, perform its function, and then return control back to the calling program (CLIPS, 2011).

3.1 Knowledge acquisition and its representation

A critical task in the development of a knowledge-based system is the knowledge acquisition, which is the process of collecting information from any source (expert knowledge, book, manuals, etc) needed to build the system. In the case of a simulator a good reference to carry out this process are the available training procedures and the operation manuals. Usually these

documents describe the objectives of the training session, the instructor actions (initial condition, malfunctions, etc) and the required actions to operate the unit (to turn on pumps, to open valves, etc), all this information helps to build a very complete knowledge base. These documents include normal operation (start-up, normalization and shutdown operations, for each one of the power plant systems) and in many cases abnormal operations. Additional tests can be performed in the simulator with the aim of getting supplementary information, mainly in the cases of malfunctions, where there are not enough documented records.

The acquired knowledge must be formalized and ordered with the aim of being useful to the ES; this process is named "Knowledge representation". One of the most common methods to represent knowledge is the production rules. In this method, the knowledge is divided into small fractions of knowledge or rules. A rule is a conditional structure that logically relates the information contained in the part of antecedent with other information contained in the part of the consequent. A very important feature is that the knowledge base is independent of the inference mechanism used to solve problems. Thus, when the stored knowledge become obsolete, or when new knowledge is available, it is relatively easy to add new rules, delete old ones or correct existing errors. Therefore, there is no need of reprogramming all the expert system. The rules are stored in hierarchical sequence logic, but this is not strictly necessary. It may be in any sequence and the inference engine will use them in the right order to solve a problem. This approach is also called IF-THEN rules and some of its main benefits are their modularity and that each rule defines a relatively small and independent piece of knowledge. However, the process of coding the rules can be a cumbersome chore for personnel little familiar with this kind of responsibilities. Tavira-Mondragón et al. (2010b) describes a graphic tool which serves to build training exercises for a combined cycle power plant simulator, with no guidance of a human instructor. This editor contains a group of blocks where each block represents a rule (or a group of rules), and each block is customized by their characteristic parameters. Figure 10 shows in a schematic way, the graphic representation of the malfunction insertion during a training

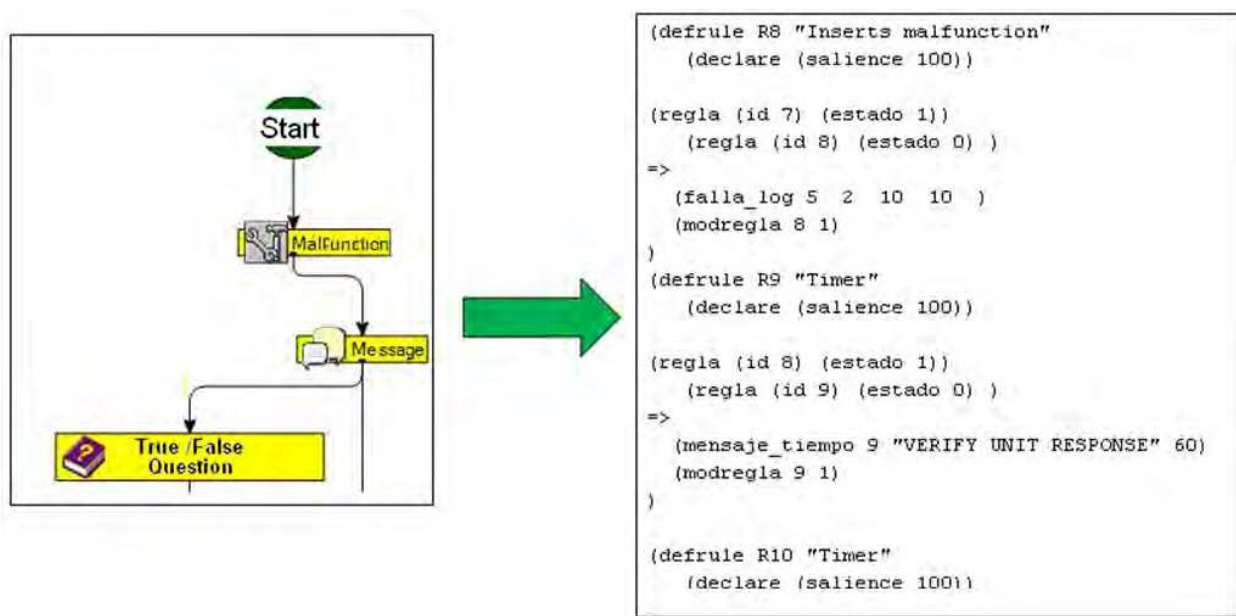

Fig. 10. Knowledge representation in CLIPS.

session and the corresponding rules generated by the editor, which are used during the execution of CLIPS as tutoring system. In such way, the ES is responsible of tracking the status of the simulation to determine the group of rules that should be fired. Due to its inference engine, and according to the configuration of the simulation exercise, the ES is able to modify the simulation process, because it can insert malfunctions, modify values of selected process variables, and change the status of the simulation without the intervention of a human instructor.

The use of ES is especially suitable for training standalone systems, because these systems incorporate: a simulator of a power plant, an intelligent tutor to guide the training session, and besides it can include the trainee evaluation and study material in some multimedia format as theoretical support of the training objectives. Naturally, the HMI for the trainee must be designed bearing in mind that the user, in addition of its operation interfaces, will need “a window” to observe the tutor messages.

4. Hardware-software architecture of a simulation system

According to the different simulator types described in the second section, the required hardware is characteristic for each one of them; therefore the next description of hardware is based on a full-scope replica simulator.

4.1 Hardware architecture

The hardware requirements are exemplified in Figure 11, where there are four PC interconnected through a fast Ethernet local area network. Each PC must have the processor and memory required to execute the simulator smoothly, and to support high processing demand functions like execution faster than real-time. The monitors of the operator consoles must be of a similar size of the ones in the actual power plant. In the case of the Figure 11, the configuration depicts monitors of 20” and 50”. During the training session, the trainee

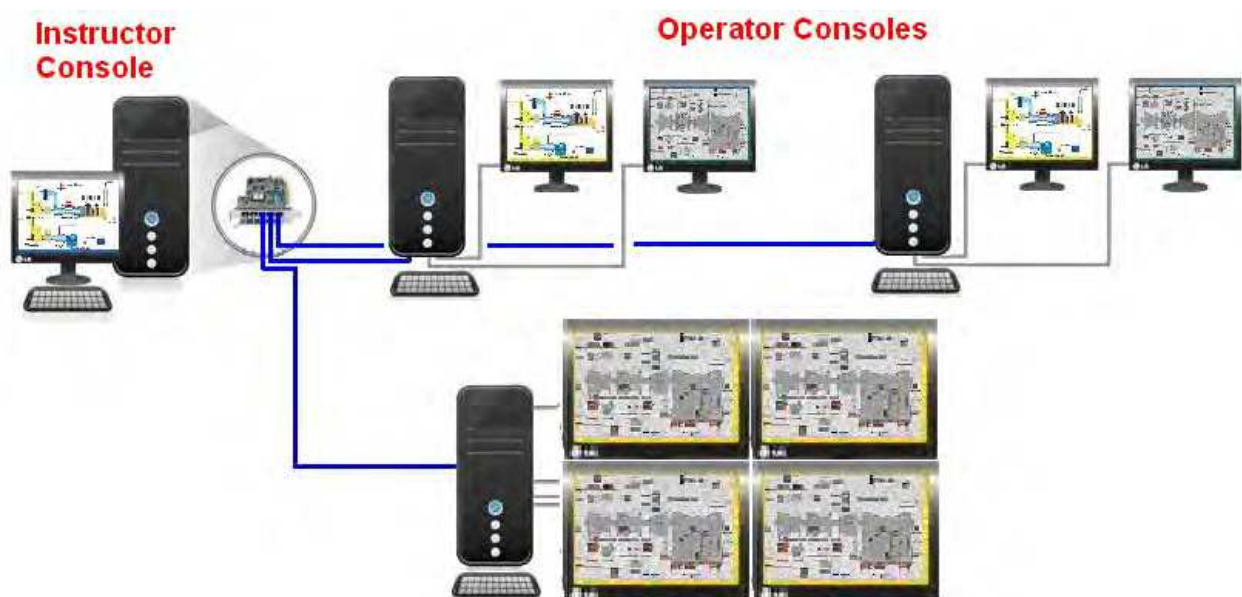

Fig. 11. Hardware architecture.

can use any one of his consoles to supervise and control any process of the power plant. The instructor console is provided with two monitors, hence, besides of using the instructor functions described previously, he can display any screen of the operator consoles with the purpose of watching any operative action carried out by the trainee. In many architectures of simulators is common to find an additional PC, the maintenance station (not shown in Figure 11), which serves as a backup if the instructor console fails or as a test station, this means that any software modification is tested and validated in this station before any change is carried out in the simulator.

4.2 Software architecture

The simulation software is designed with the purpose that the response of simulator is comparable with the results observed in the reference plant under similar conditions. As expected, besides the mathematical models, it is required the execution software or simulation environment. Tavira-Mondragón et al. (2010a) describes the software architecture for a simulation environment. The software architecture of the simulation environment has four main parts: the real-time executive, the operator module, the instructor console module, and mathematical models. Each one of these modules can be hosted in the same or in different PC, and they are connected through the TCP/IP protocol under Windows operating system. A brief description of each module is shown in the following paragraphs (the mathematical models are discussed in the next section).

- **Real-Time Executive.** The real-time executive module coordinates all simulation functions, so it includes the mathematical model launcher, the managers for: interactive process diagrams, global area of mathematical models and instructor console. Additionally it includes data base drivers and the main sequencer, which sequences all the simulator functions in real-time.
- **Operator Module.** The operator module is in charge of the operator HMI and manages the information flow with the executive system. The HMI consists of interactive process diagrams, which are animations with static and dynamic parts. The static part is constituted by a drawing of a particular flow diagram whereas the dynamic part is configured with graphic components stored in a library which are related to each one of the plant's equipment, e.g., pumps, valves, motors, etc. These components have their own properties and they are established during the simulation.
- **Instructor Console Module.** This module carries out all the tasks related to the graphical interface of the instructor and a module to dynamically update the instructor console with the simulation information.

4.3 Main features of the human machine interface for trainees

The better option for the operator console is to emulate via software the consoles of the actual plant, this represent the less cost option compared with the acquisition of such consoles, in this way a graphic imitation of the actual HMI provides a suitable operation interface. This HMI is a graphical application based on a multi-window environment with interactive process diagrams, these diagrams are organized in hierarchical levels following the organization of the power plant systems, i.e. boiler, turbine, etc. There are two main types of diagrams: information diagrams and operation diagrams. The first type shows values of selected variables. The values are presented as bar or trend graphs. The trainee

uses the operation diagrams to control and monitor the whole process, with them he operates pumps, fans valves, and also he can modify set points of automatic controls and carry out any feasible operation in a similar way as he would do in the actual power plant. When the trainee needs to perform an action, he selects the suitable pictogram with the cursor, and then a pop-up window appears with the corresponding operation buttons. At any time the trainee can open all the pictograms he wants, and can do this in any operation console. The operation diagrams also have value windows; they show a pop-up window with the value of one variable (e.g., boiler drum level, turbine speed, etc.) and its operation range. The trainee easily visualizes the off-service equipment because it is shown in white and the equipment on-service has a specific colour depending on its working fluid. To this end, green equipment handles water, blue equipment handles air, red equipment handles steam, and so on. Figure 12 shows the operation diagram of combustion gas, where it is open a pop-up window to start a motor.

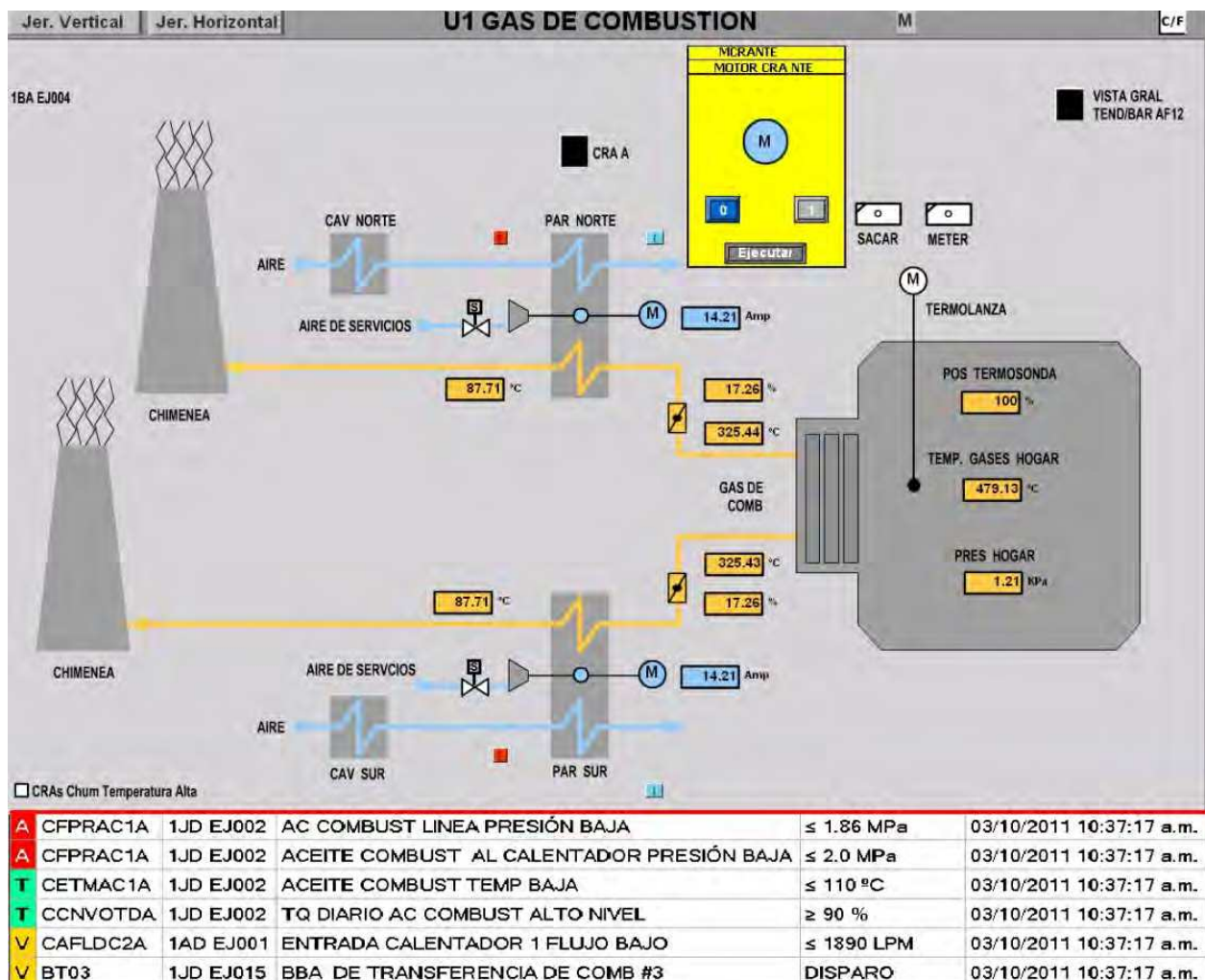

Fig. 12. Interactive process diagram

One important improvement of this kind of HMI is its capacity to show to trainee more information (temperatures, pressures, flow rates, etc.) compared to former control board simulators so it is expected that this kind of features help the operator to analyze in a better way a particular phenomena. In the bottom of the diagram displayed in Figure 12

there is a chronologic list of the alarms fired during the simulation, in this way the trainee is always notified of the occurred events. This list must be according to the alarms of the actual power plant.

The main challenge for the simulator users (operators) is the cultural change, because now operators have to utilize a modern tool like a PC instead of a control boards, therefore the operators must forget their former operation habits and adopt novel operation techniques for a fluent and safe navigation in a new HMI.

4.4 Performance criteria and acceptance procedures

Usually the fidelity of a simulator is mainly based on the behaviour of a group of variables called critical parameters. These parameters are related with conservation principles of mass and energy of the power plant and they will be selected only if they can be accurately measured. Any other variable not selected as critical parameter and which is observable in the operator HMI is called no critical. Typical critical parameters are:

- Flow, pressure and temperature of main steam.
- Flow, pressure and temperature of reheat steam.
- Feedwater flow.
- Main condenser pressure.
- Fuel flow.
- Combustion air flow.
- Generated electric power.

According to the previous classification, the criteria to assess the performance of the simulator can be summarized in the following three points:

- In steady state, the maximum variation of the critical parameters is $\pm 2\%$ and for no critical parameters is $\pm 10\%$. The value of these parameters must be consistent regarding the information of the reference plant. All of this is only valid for generation states greater than 25% of rated load. Another operation states, for instance, "cold iron" can be verified to assure that all simulator parameters, e.g. temperatures, correspond with the room temperature of the simulation.
- During transients conditions, due to malfunctions or abnormal operations, the simulator must have the same trend as the one reported in the actual plant, under the same operating conditions. Regarding the permitted duration of these transients, it is suggested a maximum time variation of $\pm 20\%$ between simulation and actual data. In the absence of information, the trends and duration of the transients must be according to the expected behaviour of the existing physical phenomena.
- In any state, the simulator will not violate any physical or conservation law and its real-time operation will be assured.

The acceptance procedures define the required tests to carry out before a simulator can be ready to use it as a part of the training programmes for operators, the execution of these procedures is also a way of verifying if the simulator meets with its specification and scope. These procedures include exhaustive tests of all the hardware and software involved, the required tests can be summarized as:

- Carrying out a complete installation of the software (e.g. operating system, graphic packages, real-time executive, instructor console, mathematical models, etc). In the case of the real-time executive, instructor console and mathematical models, a good practice is carrying out a complete compilation and rebuilding all solution projects with the aim of guarantying a full compatibility between the source and executable codes.
- Verifying the communication among the stations of the local area network.
- Validating each one of the functions of the instructor console and the operator HMI, according to their corresponding specifications.
- Carrying out availability tests with no aborts in any simulator task. This includes a continuous simulation for time periods of at least eight hours with a minimum availability of 95 %.
- Carrying out operative tests from cold iron to full-load generation, shutdown operations and malfunctions. The operative tests must be well documented with their specific objectives and the expected results for each one of the operative manoeuvres.
- The application of the acceptance procedures and the documentation of the found discrepancies are key elements in the final tuning of the simulator, before it can be released for its commercial use.

The general requirements of fossil fuel power plant simulators are well defined by the Instrument Society of America (ISA) and the Electric Power Research Institute (EPRI). These entities provide extensive guides related to the design, development, fabrication, performance, testing, training, documentation and installation of power plant simulators.

5. Mathematical modelling

In training simulators, the mathematical models must be able to reproduce, in a dynamic way, the behaviour of the power plant in any feasible operation, this includes: steady states from cold iron up to full-load generation, and transients states, as a part of operation itself or because of malfunctions. The better way of accomplishing this is using physical modelling techniques, where the conservation of mass, momentum and energy are always fulfilled.

5.1 The procedural approach

The focus of procedural programming is to break down a programming task into a collection of variables, data structures and subroutines. EPRI (1983) published in 1983 an approach named Modular Modelling System (MMS), which provided an economical and accurate computer code for the dynamic simulation of fossil and nuclear power plants. Some of the most important uses of the MMS were: evaluation of plant design, checkout of control systems, operational procedures development, diagnosis of plant performance and training simulator qualification. MMS is based on the methodology of resistive and capacitive components or combinations of them depending of which variables are transmitted between adjacent modules (causality). According to this theory, resistive components are related with the simulation of the elements which involve a pressure variation in the process (valves, pumps, etc) and the storage of mass and energy are neglected. Usually, the behaviour of the resistive elements is represented by algebraic non-linear equations. For instance, in the case of a valve for incompressible fluid, the equation to calculate the flow is obtained from the steady state momentum equation and it is:

$$w = K A p \sqrt{\rho(P_i - P_o)} \quad (1)$$

where: w is the flow, K is the valve conductance, $A p$ is the valve position, ρ is the density, P_i and P_o are the inlet and outlet pressures.

In the case of elements like pumps and fans, an approach based in the operation curves of the actual equipment is preferred because it gives a complete representation of the flow-pressure behaviour to any operation speed. For instance, in the case of a centrifugal pump, from the nominal data of the head-volumetric flow rate curve (H vs. q), the application of a least squares fitting gives the following expression:

$$\Delta H = a + b q + c q^2 \quad (2)$$

where: ΔH is the head developed by the pump, q is the volumetric flow rate and a , b , c are the coefficients obtained from the least squares fitting. The application of the pump affinity laws and the relationship for the developed head transforms the former equation in another one in terms of the flow, discharge pressure and pump speed, which is more suitable for the simulation.

$$P_o - P_i = A \rho \Omega^2 + B \Omega w + C \frac{w^2}{\rho} \quad (3)$$

where: w is the flow, P_i and P_o are the inlet and outlet pressures, ρ is the density, Ω is the angular speed and A , B , C are the transformed coefficients depending on pump nominal data.

On the other hand, capacitive elements are those which have a storage effect in the process (tanks, metal walls, etc). In this case the equations of the element are based on the lumped parameters approach; this approach simplifies the description of the behaviour of spatially distributed physical systems into a topology consisting of discrete entities that approximate the behaviour of the distributed system under certain assumptions, e.g. perfect mixing, which assumes that there are no spatial gradients in a given physical envelope, so the outlet stream has the same conditions of the fluid inside a control volume. In this way, to model a tank of constant volume with a single-phase fluid, the mass conservation equation yields:

$$\frac{d\rho}{dt} = \frac{w_i - w_o}{V}; \quad \rho|_{t=0} = \rho_0 \quad (4)$$

where ρ is the density, t is the time, w_i and w_o are the inlet and outlet flows and V is the volume. The energy conservation equation with no work is expressed as:

$$\frac{dU}{dt} = w_i h_i - w_o h + Q; \quad U|_{t=0} = U_0 \quad (5)$$

where U is the total internal energy, h_i and h are the inlet and outlet enthalpies and Q is the heat flow rate. For an incompressible fluid, the internal energy is equal to its enthalpy, and with the assumption of perfect mixing, equation (5) is transformed in:

$$\frac{dh}{dt} = \frac{w_i (h_i - h) + Q}{\rho V}; \quad h|_{t=0} = h_0 \quad (6)$$

the heat flow rate can be evaluated as:

$$Q = j A (T_w - T) \quad (7)$$

where A is the area of the heat-transfer surface, T_w is the wall temperature, T is the fluid temperature and j is the heat transfer coefficient. In the previous equations, there are the following types of variables:

- System states. They are the independent variables of the model and they will establish the operation state of the simulator at any time. In the tank model, these variables are ρ and h , which are related with the solution of their ordinary differential equations.
- Initial guess for iterative methods. They are the variables related with the solution of algebraic equations (mainly non-linear) which requires an initial guess to converge to their solution. In the case of a single valve (Equation 1) this cannot be required, but in a complete system of a simulator, e.g. the feed water system for a combined cycle power plant, which have more than 30 valves, 4 pumps, and several pipe fittings, the solution turns more complicated, and usually the problem will be based on the solution of a simultaneous system of nonlinear equations.
- Fluid properties calculations. In the simulation of power plants, the calculation of thermodynamic properties of the water (liquid and steam) is essential for a accurate representation of the phenomena occurred in the power plant. This calculation includes the evaluation of densities, enthalpies, entropies, viscosities, etc. The calculation of properties for lubricating oil, fuel, combustion gas and air are also required.
- Design data of equipment. The physical size and nominal operation data of the actual equipment are very important because they determine the dynamic response of the simulator. For instance, this type of data includes: nominal flow rates, size and type of valves; operation curves of pumps and geometry of tanks.
- Empirical functions. These calculations are related with the use of empirical functions available in the literature like heat transfer coefficients and friction factors.

Many times the conservation equations do not give, in a straight way, the information required for the simulated control elements or for the operator HMI, therefore, it is necessary to introduce additional expressions to transform the Equations (4) and (6) in terms of measurable variables like liquid height (L) and temperature (T). This can be easily made with the definitions of density and heat capacity at constant pressure (C_p) and considering a tank with constant cross-sectional (a), the result is:

$$\frac{dL}{dt} = \frac{w_i - w_o}{\rho a}; \quad L|_{t=0} = L_0 \quad (8)$$

$$\frac{dT}{dt} = \frac{w_i (h_i - C_p T) + Q}{\rho V C_p}; \quad T|_{t=0} = T_0 \quad (9)$$

for the deduction of the former equations it is assumed that density and heat capacity are constants in the validity range of the model.

In their original version, the use of the MMS requires a simulation language like EASY-5 and ACSL, which are in charge of gathering, sorting and solving all the equations related

with the system to simulate (Murthy, 1986). This kind of languages use common procedural languages, such as FORTRAN or C, in this way, the whole system model is a collection of procedure calls and the assembling and connecting of the various components of a large system is performed through a sequence of elementary commands merely specifying the desired topological connections between modules. The language automatically translates these orders into equivalent FORTRAN or C statements and aligns a consistent set of variables names to all quantities transmitted from one module to another. The language organizes the order in which the equations are solved in order to satisfy causality. In other words, all model representations are translated into C or FORTRAN language source code for compilation and execution, with the aim of ensuring a fast performance. The current version of ACSL available for PC keeps its basis on FORTRAN and C languages (acslX, 2010).

Due to the industry of training simulators grew during the 80's and a big expense was done to create it, each one of the simulators builders have their own mathematical models libraries, and it is common to find that the core of installed simulators still have their mathematical models running in modern versions of FORTRAN compilers.

5.2 The object oriented approach

The Object-Oriented Programming (OOP) is based on to divide a programming task into objects where each one of these objects encapsulates its own data and methods (procedures associated with a class). The most important distinction regarding Procedural Programming (PP) is that this one uses procedures to operate on data structures, whereas the OOP uses procedures and data structures together. In object-oriented modelling, the objects are packages of data and functionalities and the methods can be sent to these objects rather than data only, as in PP. The main disadvantage of OOP compared with the PP is that the last one has a faster execution, which in real-time applications is an essential issue, in past decades, due to restrictions of memory and processing capacity, this arose as a serious problem, but nowadays, with the available computing power, the OOP is a feasible alternative to develop training simulators.

Leva and Maffezzoni (2003) establish some paradigms of the OOP in mathematical modelling; one of the most important is the definition of physical ports as the standard interface to connect a certain component model. In this way, an object is the mathematical model of a power plant component (e.g. valve, pump, etc) and the integration of these objects reflects the physical plant layout. The interactions among the components are satisfied with the flow information of the connectors, which are also related with the physical connections. Figure 13 describes these concepts, each one of the icons represents a physical component and according to this, it has defined their suitable communication ports (small coloured squares). The lines between two icons are equivalents to the actual physical connections. Table 2 shows some connector types.

Although it is not destined to serve as a platform to develop training simulators, Modelica (Modelica, 2011) is representative of this kind of technologies. Modelica is a non-proprietary, object-oriented, equation based language to conveniently model complex physical systems containing, e.g., mechanical, electrical, electronic, hydraulic, thermal, control, electric power or process-oriented subcomponents. Therefore, Modelica is a modelling language rather than a true programming language. The Modelica classes are not compiled in the usual sense, but are translated into objects which are then executed by a simulation engine.

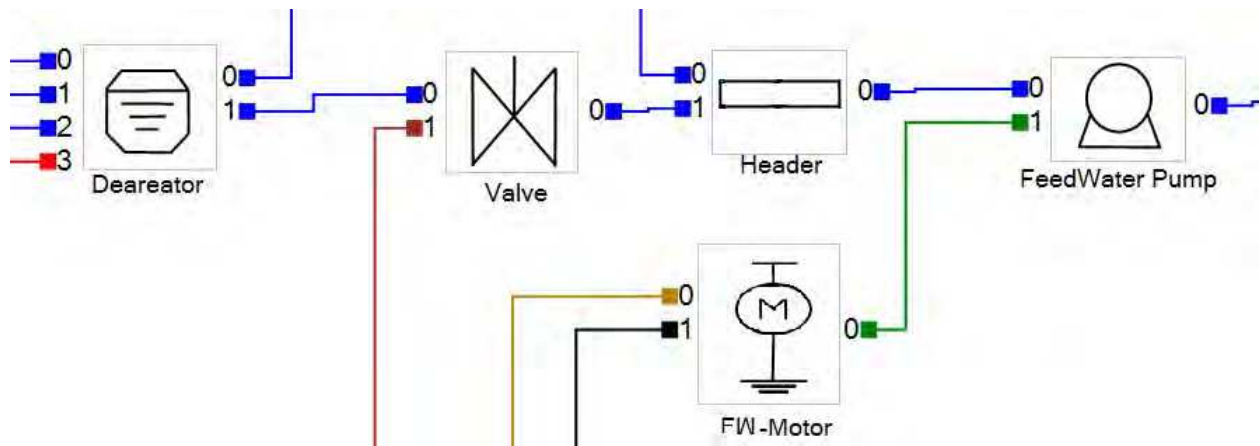

Fig. 13. Object oriented approach

Connector	Information
Hydraulic	<ul style="list-style-type: none"> • Pressure • Total Flow rate • Liquid fraction • Density • Enthalpy • Composition
Actuator	<ul style="list-style-type: none"> • Valve position
Mechanical Motion	<ul style="list-style-type: none"> • Mechanical torque • Angular speed
Thermal	<ul style="list-style-type: none"> • Temperature • Heat rate
Electric	<ul style="list-style-type: none"> • Voltage • Current

Table 2. Connector types.

Tavira-Mondragón et al. (2010c) describe an OOP development with the aim of modelling and developing simulators of power plants. Based on the previously discussed concepts of components, ports and connectors; these authors present a specially designed editor to fulfil the requirements of these kind of applications. This editor was designed using the design pattern Model-View-Controller (MVC). In this context, the Model component is the instantiation of each generic component including their connectors, and the result of putting together the required components is the construction of the mathematical model to simulate. The View is the graphical representation of the Model, i.e. each one of the elements of the Model is represented by a graphic icon. The Controller component is responsible of maintaining consistency between the View and Model; therefore, any change to the Vista (user interaction) will be reflected in the Model and vice versa. The result of the editing process is a simulation diagram. During the edition of a complete diagram, the generic elements are linked by mean of a set of connectors in various domains. These connectors specify the information flow among different elements of the diagram. The simulation of a diagram consists in calling in an orderly way the diagrams. During the simulation sequence, and for each one of the diagrams, it is built a data structure, which represents a directed graph, this graph has the

topology of the simulated diagram and serves to construct the mathematical solution of the system (Solver). For instance, in a flow-pressure network, the nodes are the points of the network where the process lines are joined or split, if there is not considered accumulation of materials in these nodes, the solution of the continuity equation in steady state for all the nodes yields a system of simultaneous nonlinear algebraic equations.

Depending of their complexity, no matter the selected simulation approach, the mathematical models are constituted by: linear algebraic equations, nonlinear algebraic equations, differential equations or a combination of them. Linear equations are resolved with LU decomposition methods, for instance, the solution of the admittance matrix of the electric network. Methods of Newton-Raphson with relaxation techniques are utilized to resolve the algebraic nonlinear equations, for instance, flow-pressure networks where the Jacobian matrix can be calculated with the analytical first-order partial derivatives with respect to the pressures of the nodes. The differential equations can be resolved with implicit or explicit integration methods, according to the simulator solver. Examples of these equations are (8) and (9) or the speed equation of the electric generator. Tolsma and Barton (2002) highlight several numerical algorithms used to solve common problems that arise during process modelling, including solution of systems of nonlinear equations and numerical integration.

Regarding to general-purpose graphic modelling tools, MATLAB-SIMULINK (Mathworks, 2011) is a remarkable product due to its integrated simulation environment, mathematics libraries and toolboxes (e.g. control, data acquisition and signal processing). Some developments using MATLAB-SIMULINK are reported by Lu (1999), who presents the simulation of 677 MW coal and gas-fired power plant, with the aim of obtaining a good insight into boiler dynamics and steady state performance. Another development is reported by Alam-Jan et al. (2002). These authors describe a training simulator for operators of a coal-fired power plant, and they claim that their nonlinear models implemented are moderately complex but reproduces the dynamic behaviour of the actual plant over a wide operation range.

Finally can be pointed that, no matter the selected approach or the computational tools used for the integration of a training simulator, the mathematical models must provide a realistic and consistent response in a wide operation range, this include any transient and steady state of the simulated power plant..

Additional issues about mathematical modelling and the application of dynamic simulators are discussed by Cameron et al. (2002).

5.3 Modelling of control systems

The Distributed Control System (DCS) of a power plant is a group of Programmable Logic Controllers (PLC) where all the control algorithms are executed in an automatic way. A DCS is a very complex system involving many thousands of signals and hundreds of diagrams. The control algorithms are organized in components with specific function or task, for instance: PID controllers, high/low detectors, timers, memories set/reset, etc. This organization is represented by means of a network of these components, which communicate information through connections, (Figure 14). These networks are organized in a hierarchical way, in the bottom levels are the basic elements like AND, OR, NOT gates, in the middle level are the diagrams, and finally in the top level are the modules. In this way, the DCS is constituted by a collection of modules.

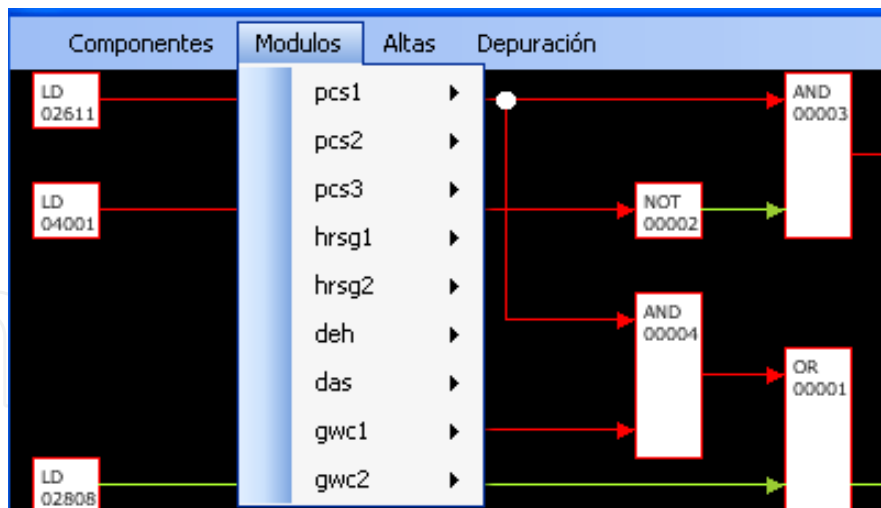

Fig. 14. Control diagram of a DCS

One of the most viable approaches to simulate the DCS is the translation of the control algorithms of the actual power plant; this guarantees a full reproduction of all control loops, alarms and signals to the HMI. In the context of a simulator and according to the methodology described by Romero-Jiménez et al. (2008), the translation procedure involves mainly the next tasks:

- Building the libraries of analogue and logic components (e.g. PID controllers, logical gates, timers, etc.)
- Organizing the component execution sequence.
- Creating structures in order to store component states.
- Designing interfaces with a description outside software implementation, so the code requiring an interface can use any component/object (Polymorphism).
- Design and implementation of a control component database.
- Implementation of an on-line visor to verify and visualize signals, states, inputs, outputs and parameters of components during simulation. This visor allows disabling diagrams, modules or components, in this way, it is possible isolate components and verifying their behaviour.

In the case of small control systems or when the control loops are not included in the DCS for its translation, these control algorithms can be developed by means of a graphical tool like VisSim (VisSim, 2011), using as reference the SAMA diagrams of the actual power plant. VisSim provides almost all the basic modules required to model control systems and generates C code, so it can be easily coupled to the simulator solver. In such way, the SAMA diagrams can be drawn totally in the VisSim environment to reproduce the required control. As expected, it is necessary coding in a manual way the modules with a specific function do not available in the VisSim libraries.

6. Conclusion

Training programmes for power plant operators using dynamic simulator have been used extensively in many parts of the world during the last 30 years, and their direct benefits in unit availability, thermal performance, environmental compliance and safe operation have

been proven and documented. It is important to mention that, simulators are a very important part of these programmes, but their value as training tool is maximized when they are integrated in well-designed and structured training courses. The ADDIE model is a suitable methodology to get this goal.

The increase of power computing and the development of friendly graphical user interfaces had two main effects over the simulators; on the one hand, the power plants have replaced their former control boards with personal computers with graphical user interfaces. Naturally, the operators of these plants need a suitable training because they face a complete change in their operation paradigm, and because of this, the training simulators also require a HMI as the ones in the actual plants. On the other hand, a complete simulator can be installed in a single PC, with no demerit of the scope of the mathematical modelling or its real-time functioning. Furthermore, web services and cloud computing extend the training options, because specific training objectives can be fulfilled just with a PC with an internet connection. This kind of applications make possible to reach a big number of trainees with no necessity of: transporting personnel to a training centre, transporting a simulator to different places, or acquiring a simulator. Another important aspect is the inclusion of expert systems in a training simulator. This option is suitable for standalone applications which require reducing or even eliminating the necessity of a human instructor. A convenient knowledge representation of the expert gives to the simulation system all the elements to conduct a training session in an autonomous way.

In the Object-Oriented Programming, an object is the mathematical model of a power plant component and the integration of these objects reflects the physical plant layout. The interactions among the components are satisfied with connectors, which are also related with the actual physical connections; this type of approaches simplifies the construction of simulators and provides a direct relation between the physical and simulated systems.

7. References

- acslX (2010). acslX Software for Modeling and Simulation of Dynamic Systems and Processes, 21.09.2011, Available from <http://www.acslx.com/products/>
- Ahmad, A.L.; Low, E.M. & Abd Shukor, S.R. (2010). *Safety Improvement and Operational Enhancement via Dynamic Process Simulator: A Review*, Chemical Product and Process Modeling: Vol. 5, No. 1, Article 25, pp 1-25.
- Arjona, M.; Hernández, C. & Gleason, E. (2003). *An Intelligent Tutoring System for Turbine Startup Training of Electrical Power Plant Operators*. Expert Systems with Applications, Vol. 24, No.1, pp. 95-101.
- Alam-Jan, S.; Šulc, B. & Neuman, P. (2002). Object Oriented Modeling of a Training Simulator, *Proceedings International Carpathian Control Conference ICC' 2002*, pp 757-762, May 27-30, 2003. Malenovice, Czech.
- Burgos, E. (1993). *Simulador de Rodado de Turbine para el Adiestramiento de Operadores*, Boletín IIE, Vol. 17, No. 4 pp. 167-172.
- Cameron, D.; Clausen, C. & Morton, W. (2002). Chapter 5.3 Dynamic Simulators for Operator Training, In: *Software Architectures and Tools for Computer Aided Process Engineering-Computer-Aided Chemical Engineering, Vol. 11*), Braunschweig, I. & Gani, R., pp. 393-432, Elsevier, ISB N: 0-444-50827-9, The Netherlands.

- CLIPS, A Tool for Building Expert Systems, 20.09.2011, Available from <http://clipsrules.sourceforge.net>
- EPRI (1983). *Modular Modeling System (MMS): A Code for the Dynamic Simulation of Fossil and Nuclear Power Plants*. Report CS:NP 3016, Electric Power Research Institute, U.S.A.
- EPRI (1993). *Justification of Simulators for Fossil Fuel Power Plants*, Technical Report TR-102690, Electric Power Research Institute, U.S.A.
- EPRI (1998). *Simulator Procurement Guidelines for Fossil Power Plants: Simulator Specifications-AD-103790*, Electric Power Research Institute, U.S.A.
- EPRI (2005). *Guidelines for the Development of an Initial Systematic Training Program-1009849*, Electric Power Research Institute, U.S.A.
- Fray, R. & Divakaruni M. (1995). Compact Simulators Can Improve Fossil Plant Operation, *Power Engineering*, Vol. 99 No. 1, pp. 30-32, ISSN 0032-5961.
- Hoffman, S. (1995). A New Era for Fossil Power Plant Simulators, *EPRI Journal*, Vol. 20, No. 5, pp. 20-27.
- IAEA (1996). *Nuclear Power Plant Personnel Training and its Evaluation a Guidebook Technical-Reports Series No. 380*, International Atomic Energy Agency, Austria.
- IAEA (1998). *Selection, Specification, Design and Use of Various Nuclear Power Plant Training Simulators-IAEA-TECDOC-995*, International Atomic Energy Agency, ISSN-1011-4289, Austria.
- IAEA(2003). *Means Of Evaluating And Improving The Effectiveness Of Training Of Nuclear Power Plant Personnel-IAEA-TECDOC-1358*, International Atomic Energy Agency, ISBN-92-0-108204-7, Austria.
- IAEA (2004). *Use of Control Room Simulators for Training of Nuclear Power Plant Personnel-IAEA-TECDOC-1411*, International Atomic Energy Agency, ISBN-92-0-110604-1, Austria.
- ISA (1993). *Fossil-Fuel Power Plant Simulators-Functional Requirements-ISA-S77.20-1993*, Instrument Society of America, ISBN-1-55617-494-2, U.S.A.
- Leva, A. & Maffezzoni, C. (2003). Modelling of Power Plants, In: *Thermal Power Plant Simulation and Control*, Flynn, D., pp 16-60, Knovel, Available from http://www.knovel.com/web/portal/browse/display?_EXT_KNOVEL_DISPLAY_bookid=1399
- Liao, S. (2005). *Expert System Methodologies and Applications – A Decade Review from 1995 to 2004*, Expert Systems with Applications, Vol. 28, No.1, pp 93–103.
- Lu, S. (1999). *Dynamic Modeling and Simulation of Power Plant Systems*, Proceedings of the Institution of Mechanical Engineers, Part A: Journal of Power and Energy, Vol. 213, No. 1, pp. 7-22
- Martínez-Ramírez, R.; Romero-Jiménez, G. & Martínez-Cuevas, S. (2011). What's New About Enabling Technologies in Power Plant Simulators and Training Systems: Visor3D-SD Prototype (Accepted for publication), *11th IERE General Meeting and The IERE – IIE Latin American Forum*, Oct 31-Nov 3, 2011. Cancún, Q.R. México.
- Mathworks (2011). 04.09.2001, Available from <http://www.mathworks.com/index.html>
- Modelica (2011). 01.09.2011, Available from <https://modelica.org/>
- Murthy S. (1986). *The Application of Simulation in Large Energy System Analysis*, Modeling, Identification and Control, Vol. 6, No. 4, pp 231-247.
- Olmstadt, W. (2000). Cataloging Expert Systems: Optimisms and Frustrated Reality, *Journal of Southern Academic and Special Librarianship*, pp. 1-11, ISSN 1525-321X.

- Perkins, T. (1985). *Simulation Technology in Operator Training*, IAEA bulletin, Autumn-1985, pp18-23
- Pevneva, N.; Piskov, V. & Zenkov, A. (2007). An Integrated Computer-Based Training Simulator for the Operative Personnel of the 800-MW Power-Generating Unit at the Perm District Power Station, *Thermal Engineering*, Vol. 54, No. 7, (July 2007), pp. 542-547.
- Romero-Jiménez, G.; Jiménez-Fraustro, L.; Salinas-Camacho, M. & Avalos-Valenzuela, H. (2008). 110 MW Geothermal Power Plant Multiple Simulator, Using Wireless Technology, *Proceedings of World Academy Of Science, Engineering And Technology*, pp 154-159, ISSN 1307-6884, Jul 30, 2008. Paris, France.
- Romero-Jiménez, G; Jiménez-Sánchez, V. & Roldán-Villasana, E. (2008). Graphical Environment for Modeling Control Systems in Full Scope Training Simulators, *Proceedings of World Academy of Science, Engineering and Technology*, pp. 792-797, ISSN 1307-688, July 30, 2008. Paris, France
- Seifi, H. and Seifi, A. (2002). *An Intelligent Tutoring System for a Power Plant Simulator*, Electric Power Systems Research, Vol. 62, No. 3, pp. 161-171.
- Serious Games LLC, Plant Simulator (2006). 15.08.2011, Available from <http://plantsimulator.com/chooseplantsim.html>
- The Free Dictionary (2008). 11.08.2011, Available from <http://www.thefreedictionary.com/simulator>
- Tavira-Mondragón, J.; Parra-Gómez, I. & Martínez-Ramírez, R. (2005). 350 MW Fossil Power Plant Multiple Simulator for Operators Training, *Proceeding of the Eight IASTED International Conference Computers and Advanced Technology in Education*, pp 492-497, Aug. 29-31, 2005, Oranjestad, Aruba.
- Tavira-Mondragón, J.; Parra-Gómez, I.; Melgar-García, J.; Cruz-Cruz, R. & Téllez-Pacheco, J. (2006). A 300 MW Fossil Power Plant Part-Task Simulator, *Proceedings of Summer Simulation Multiconference*, pp. 291-297, Calgary Alberta Can., Jul 30-Aug 3, 2006.
- Tavira-Mondragón, J.; Jiménez-Fraustro, L. & Romero-Jimenez, G. (2010a). *A Simulator for Training Operators of Fossil-Fuel Power Plants with an HMI Based on a Multi-Window System*. International Journal of Computer Aided Engineering and Technology, Vol. 2, No. 1, pp. 30-40.
- Tavira-Mondragón, J.; Martínez-Ramírez, R.; Jiménez-Fraustro, F.; Orozco-Martínez, R. & Rafael Cruz-Cruz (2010b). Power Plants Simulators with an Expert System to Train and Evaluate Operators, *Proceeding of the World Congress on Engineering and Computer Science 2010, WCECS 2010*, ISBN 978-988-18210-0-3, Oct. 20-22, 2010, San Francisco, Cal., USA.
- Tavira-Mondragón, J.; Jiménez-Fraustro, F. & Jiménez-Fraustro, L. (2010c). Graphical Environment to Simulate Power Plants, *Proceeding of the UKSim Fourth European Modeling Symposium on Computer Modeling and Simulation*, pp 289-294, Nov. 17-19 2010, Pisa, Italy.
- Tolsma, J. E. & Barton, P. I. (2002). Chapter 3.2 Numerical Solvers, In: *Software Architectures and Tools for Computer Aided Process Engineering-Computer-Aided Chemical Engineering, Vol. 11*), Braunschweig, I. & Gani, R., pp. 127-164, Elsevier, ISB N: 0-444-50827-9, The Netherlands.
- VisSim (2011). 17.09.2011. Available from <http://www.vissim.com>
- Wikipedia, The Free Encyclopedia (2011a). 16.09.2011, Available from

- http://en.wikipedia.org/wiki/Cloud_computing
Wikipedia, The Free Encyclopedia (2011b). 20.09.2011, Available from
<http://en.wikipedia.org/wiki/CLIPS>
- Yamamori, T.; Ichikawa, T.; Kawaguchi, S. & Honma, H. (2000). *Recent Technologies in Nuclear Power Plant Supervisory and Control Systems*, Hitachi Review, Vol. 49, No. 2, p61-65.
- Zabre E. & Román R. (2008). Evolution, Tendencies and Impact of Standardization of Input/Output Platforms in Full Scale Simulators for Training Power Plant Operators, *Proceedings of World Academy of Science, Engineering and Technology*, pp. 904-912, ISSN 1307-6884, Jul 2008. Paris, France.

IntechOpen

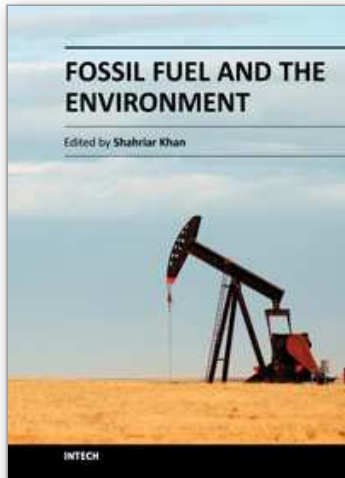

Fossil Fuel and the Environment

Edited by Dr. Shahriar Khan

ISBN 978-953-51-0277-9

Hard cover, 304 pages

Publisher InTech

Published online 14, March, 2012

Published in print edition March, 2012

The world today is at crossroads in terms of energy, as fossil fuel continues to shape global geopolitics. Alternative energy has become rapidly feasible, with thousands of wind-turbines emerging in the landscapes of the US and Europe. Solar energy and bio-fuels have found similarly wide applications. This book is a compilation of 13 chapters. The topics move mostly seamlessly from fuel combustion and coexistence with renewable energy, to the environment, and finally to the economics of energy, and food security. The research and vision defines much of the range of our scientific knowledge on the subject and is a driving force for the future. Whether feasible or futuristic, this book is a great read for researchers, practitioners, or just about anyone with an enquiring mind on this subject.

How to reference

In order to correctly reference this scholarly work, feel free to copy and paste the following:

José Távira-Mondragón, Guillermo Romero-Jiménez and Luis Jiménez-Fraustro (2012). Fossil Fuel Power Plant Simulators for Operator Training, Fossil Fuel and the Environment, Dr. Shahriar Khan (Ed.), ISBN: 978-953-51-0277-9, InTech, Available from: <http://www.intechopen.com/books/fossil-fuel-and-the-environment/fossil-fuel-power-plant-simulators-for-operator-training>

INTECH
open science | open minds

InTech Europe

University Campus STeP Ri
Slavka Krautzeka 83/A
51000 Rijeka, Croatia
Phone: +385 (51) 770 447
Fax: +385 (51) 686 166
www.intechopen.com

InTech China

Unit 405, Office Block, Hotel Equatorial Shanghai
No.65, Yan An Road (West), Shanghai, 200040, China
中国上海市延安西路65号上海国际贵都大饭店办公楼405单元
Phone: +86-21-62489820
Fax: +86-21-62489821

© 2012 The Author(s). Licensee IntechOpen. This is an open access article distributed under the terms of the [Creative Commons Attribution 3.0 License](#), which permits unrestricted use, distribution, and reproduction in any medium, provided the original work is properly cited.

IntechOpen

IntechOpen