

We are IntechOpen, the world's leading publisher of Open Access books Built by scientists, for scientists

4,800

Open access books available

122,000

International authors and editors

135M

Downloads

Our authors are among the

154

Countries delivered to

TOP 1%

most cited scientists

12.2%

Contributors from top 500 universities



WEB OF SCIENCE™

Selection of our books indexed in the Book Citation Index
in Web of Science™ Core Collection (BKCI)

Interested in publishing with us?
Contact book.department@intechopen.com

Numbers displayed above are based on latest data collected.

For more information visit www.intechopen.com



Stable Isotope Applications in Bone Collagen with Emphasis on Deuterium/Hydrogen Ratios

Katarina Topalov, Arndt Schimmelmann, P. David Polly and Peter E. Sauer
*Department of Geological Sciences, Indiana University, Bloomington
USA*

1. Introduction

The broad scope of isotopic applications of bone collagen ranges from modern ecological and physiological investigations to learning about living conditions of animals in the past (Ambrose & DeNiro, 1989; Chisholm et al., 1982; DeNiro & Epstein 1978, 1981; DeNiro & Weiner, 1988; Hare et al., 1991; Hedges & Law, 1989; Leyden et al., 2006; Lis et al., 2008; Reynard & Hedges, 2008). Bone collagen represents one of the best preserved proteins in fossilized animal remains that in some cases has been chemically preserved for up to 120,000 years (Bocherens et al., 1999). Collagen is protected from degradation by being encapsulated into the bone mineral bioapatite. In comparison to other biopolymers found in the archaeological record, bone collagen is relatively abundant, easily extracted, and offers a long-term record of the life of humans and animals (Collins et al., 2002). Stable isotope ratios in the living biomass directly relate to the stable isotope ratios of life-supporting substrates in the environment. Animals integrate stable isotopes into their biomass through the air we breathe, water we drink and food we eat. Despite the apparent permanence of mineral constituents of bone, the organic components undergo constant turnover through the life of a vertebrate and its collagen content represents a 'running average' of months, years, or a lifetime, depending on the specific bone and the animal. Bone collagen thus offers a valuable insight into the environmental conditions during part of or the entire life of an animal (Lee-Thorp, 2008; Tuross et al., 2008). Carbon and nitrogen stable isotopes of bone collagen have been in broad use in determining diets, paleodiets, trophic levels, and paleoenvironments associated with modern and fossilized bone samples (Ambrose & DeNiro 1989; Chisholm et al., 1982; Hare et al., 1991; Schwarcz, 2000; Walker & DeNiro, 1986; Walter & Leslie, 2009), while other isotopes are only recently finding useful applications. Hydrogen is unique among all elements in terms of the doubling of the atomic mass from the light hydrogen nuclide protium ^1H to the less abundant, but heavier nuclide deuterium ^2H (or traditionally also abbreviated as D). This large mass difference between the two stable hydrogen isotopes creates strong fractionation effects (i.e. the preferential use or participation of one of the two isotopes in chemical and physical processes) and generates an extremely wide natural isotopic range of hydrogen stable isotope ratios (Sessions et al., 1999). Available hydrogen stable isotope data from bone collagen suggest greater variability than the most of the earlier studies had presumed, a situation that would compromise the diagnostic value of individual forensic collagen δD values for many species.

2. Structure, chemistry and preservation potential of bone collagen

Bone represents a complex system composed of 70% mineral and 30% organic material by weight when dried, and about 90% of the organics are collagen, a fibrous, high-tensile-strength protein functioning as a supportive framework (Hedges et al., 2006) and effectively playing the role of strands of steel in reinforced concrete. Remaining organic material in live bone reflects cells, lipids and other proteins (Price et al. 1985). Although the metabolic rates of bone tissues are low relative to those of the musculature, digestive, or dermal tissues, exchange of metabolites does occur and bone cells are constantly created and reabsorbed. The mineral phase of bone (bioapatite) protects collagen and other bone proteins from rapid *post-mortem* decomposition by physically shielding them from the external environment, especially from microbial access. The encapsulation of bone collagen by mineral crystallites is termed ‘mineral stabilization’ (Collins et al., 2002). In fact, the entire bone may be considered to be a mineralized collagen (Collins et al., 2002).

Collagens are the most common proteins in the matrix of connective tissues such as bone, cartilage, and dentine (Fig. 1) and form a group of over 20 fibrillar and microfibrillar proteinaceous macromolecules that share a triple helix structure that gives them great tensile strength (Gelse et al., 2003). Three collagen helices are coiled into a super helix in the collagen molecule (Price et al., 1985). Collagen found in bone is so-called type I collagen (Gelse et al., 2003) and can also be found in skin, tendons and other tissues, which makes it the most abundant of approximately 20 collagen species. The three helices in bone are $\alpha 1$ and $\alpha 2$ chains. Two identical $\alpha 1$ chains and one $\alpha 2$ chain form a highly organized superstructure, in which the fibrils are tightly packed in parallel orientation to yield a tissue with excellent tensile strength, pressure resistance and torsional stiffness (Gelse et al., 2003). A typical sequential order of amino acids is $(\text{Gly-X-Y})_n$ where Gly stands for glycine, the most frequent amino acid in collagen, and X and Y are other amino acids, most commonly

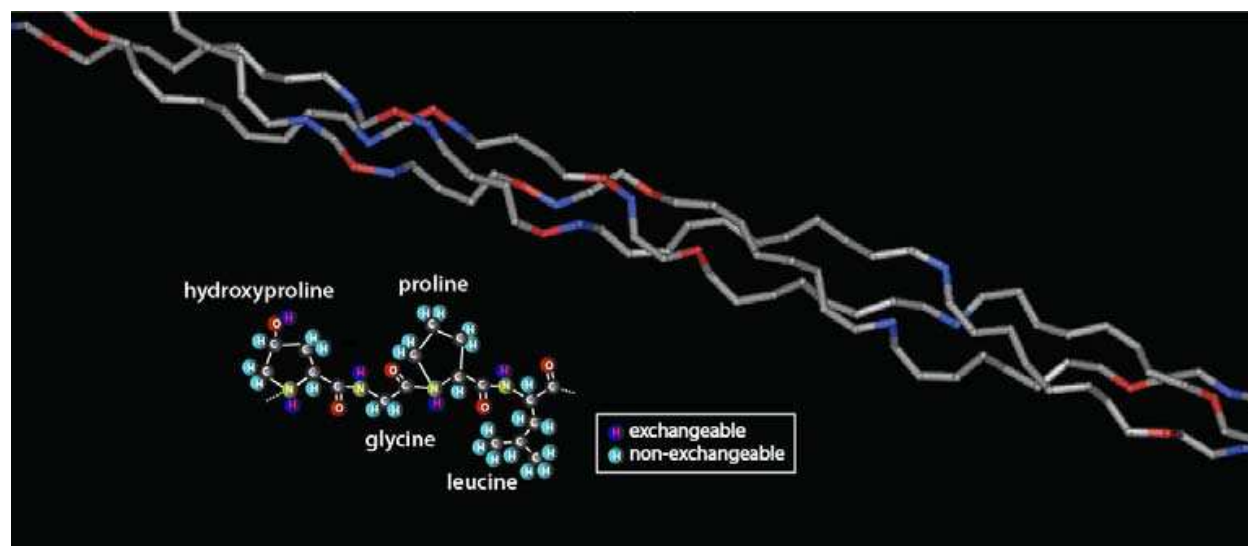

Fig. 1. Triple helix structure of Type I collagen from *Rattus norvegicus*. Three helical collagen proteins are intertwined. Color coding in the triple helix shows the charge of individual residues, positive in blue, negative in red, and neutral in grey (produced from data in GenBank, MMDB ID: 38933). The positions of exchangeable and non-exchangeable hydrogen atoms in 4 linked amino acids are simplistically depicted in the lower insert.

proline and hydroxyproline (Eyre, 1980). The Gly-X-Y triplets in this type of collagen repeat to about 300 times forming chains of approximately 1000 amino acid monomers (Gelse et al., 2003). Glycine is the smallest amino acid having one carbon-linked hydrogen atom in place where other amino acids carry a side chain. Proline, the second most common amino acid in collagen, has a cyclical structure that enables coiling of the helices (Balzer et al., 1997). Collagen also contains two amino acids uncommonly found elsewhere – hydroxyproline and hydroxylysine. The two do not occur freely outside collagen, but are derived from hydroxylation of proline and lysine already integrated into the collagen chain (Epstein, 1970). Hydroxyproline is responsible for linking the three α -helices with hydrogen bonds, and hydroxylysine forms covalent bonds in the cross-linking of monomers (Balzer et al., 1997), increasing the strength and thermal stability of the superhelix (van Klinken, 1991). Smaller glycine is usually positioned towards the center of the helix axis, while the larger amino acids are placed towards the outside of the structure. This arrangement enables tighter coiling of the helix and a more compact and stronger macromolecule (Gelse et al., 2003). The collagen biopolymer is a water-insoluble, resilient, folded structure that is resistant to chemical decay (Balzer et al., 1997).

There are approximately 200 other proteins present in bone, though most of them are present only in trace amounts (Delmas et al., 1984; Linde et al., 1980, as cited in van Klinken, 1991). The second most common bone protein, osteocalcin, comprises 1-2 weight % of total fresh bone. Osteocalcin bonds with both the bone mineral fraction and bone collagen, but it seems to be unstable in solutions. Due to its small molecular size and strong mineral stabilization, osteocalcin can survive up to 50,000 years (C.I. Smith et al., 2005), and it may offer an alternative to the use of collagen in paleoenvironmental stable isotope research. However, osteocalcin's role and importance in this field of study has yet to be defined (Collins et al., 2002).

3. Preservation of bone collagen

The value of bone collagen as an indicator of past ecological and environmental conditions depends on its durability, a quality that directly results from being embedded in resistant inorganic biominerals that protect it from physical, chemical, and microbiological attack (Ambrose & DeNiro, 1989; Collins et al., 2002; Tuross et al., 1988). While preservation varies dramatically with sedimentary conditions and is favored by cold ($<0^{\circ}\text{C}$), dry, and anoxic conditions (i.e., those that preclude biodegrading microorganisms), bone collagen is the longest lasting organic component of animal remains even in microbially active depositional environments such as soils (Child, 1995). Moreover, collagen is water-insoluble, abundant (in contrast to DNA material), homogenous (highly repetitive amino acid chains), and easy to extract from bone (Collins et al., 1995; Hedges & Law, 1989). The enhanced preservation potential of bone collagen stands in contrast to the relatively unprotected proteinaceous keratin (the dominant protein in feathers and skin) and other biopolymers like chitin and cellulose, which made collagen widely utilized in archaeological research (Collins et al., 2002; Lee-Thorp, 2008). However, the preservation of bone collagen is variable, and several methods have been developed to test bone integrity (Balzer et al., 1997). The preservation of collagen in bone depends on environmental and burial conditions, degree of decomposition, contact with soil or ground water, and the extent of leaching and other diagenetic factors (Balzer et al., 1997).

The physical and chemical *post mortem* alteration of bone is called diagenesis. Collins et al. (2002) recognize three pathways in bone degradation, namely organic-chemical deterioration of collagen, bone mineral breakdown, and microbial (biochemical) deterioration of collagen. Chemical deterioration of collagen represents a gradual loss of collagen matter and an increase in bone porosity due to depolymerization of collagen and chemical loss of low-molecular organic compounds. This is a dominant process in bone fossilization whereby secondary pores are created in place of lost collagen and a bone remnant in this phase is called a “mineral ghost”. Secondary minerals crystallize inside the pores replacing the lost collagen fibrils. In the authors’ opinion, this is the slowest and therefore the least likely degradation pathway albeit the most influential in fossilization processes. Mineral breakdown and microbial biodegradation are faster and thus more likely to be ultimately responsible for the long-term loss of bone collagen. Tuross (2002) analyzed a set of 30,000-year old bones in an effort to estimate the level of collagen degradation. She observed a preferential loss in some of the collagen amino acids and suggested that the chemical degradation may play a greater role in collagen loss than was previously believed. Bone mineral breakdown proceeds via dissolution in water depending on the hydrology of the environment. Bone mineral dissolution will rapidly expose bone collagen and subsequently accelerate the chemical and biochemical degradation of bone collagen. While chemical collagen breakdown is accelerated by extreme pH and elevated temperatures, the biochemical (microbial) decay of collagen most effectively occurs at circum-neutral pH. The latter is a dominant diagenetic pathway because it occurs rapidly after death of an animal (Bell et al., 1996) due to the abundance of microorganisms in the environment, and lack of physiological fluids that inhibit tissue deterioration normally found within a body during life. Also, unlike organic-chemical collagen decay that occurs evenly throughout the bone, microbial attack focuses on isolated areas of the bone where microbes have access to collagen (Collins et al., 2002).

The rate of bone collagen turnover in living organisms includes terms for synthesis and catalysis, but the effective turnover rate is poorly constrained due to the difficulty of conducting the necessary *in vivo* experiments (Babraj et al., 2005). The reported estimates range from less than a year (Hobson & Clark, 1992) to 10 years (van Klinken, 1991) or over (Hedges et al., 2007). According to Waterlow (2006), the collagen turnover rate varies within the bone. The immature bone collagen (procollagen) is degraded within hours, while the mature collagen shows almost no turnover. The average rate for all bone collagen then depends on the ratio of the mature and immature collagen fractions, which are in turn dependent on life stage and level of stress (Waterlow, 2006).

4. Stable isotopes

The ratios of heavy to light stable isotopes of hydrogen $^2\text{H}/^1\text{H}$ (or D/H), carbon $^{13}\text{C}/^{12}\text{C}$, nitrogen $^{15}\text{N}/^{14}\text{N}$, oxygen $^{18}\text{O}/^{16}\text{O}$, and sulfur $^{34}\text{S}/^{32}\text{S}$ show distinctive patterns of distribution in the living world that can be used to interpret respective data from fossil samples. Stable isotope ratios in modern organisms are determined by (i) water, air and food intake, (ii) metabolic isotopic fractionations occurring inside the body, and (iii) evapotranspirative and excretory loss of material. Stable isotope ratios are typically expressed as δ (delta) values:

$$\delta(\text{‰}) = \left(\frac{R_{\text{unknown}}}{R_{\text{standard}}} - 1 \right)$$

where R is the isotope abundance ratio for sample (R_{unknown}) or standard (R_{standard}) (Coplen, 2011). Stable isotope scales use δ units and are defined by internationally recognized anchor points: Vienna-Pee Dee Belemnite (VPDB) for ^{13}C , air nitrogen for ^{15}N , Vienna Standard Mean Ocean Water (VSMOW) for ^{18}O and ^2H (e.g., Coplen, 1996). Delta values are expressed in ‰ (permil). A sample with a δD value of 20‰ is enriched in D (deuterium) by 20‰ relative to the VSMOW water standard. $\delta\text{D} = -10\text{‰}$ indicates a D-depletion of 10‰ relative to VSMOW.

4.1 Isotopic fractionation

Mass differences between the nuclei of pairs of stable isotopes of an element result in isotopic fractionations during physical transitions, transport processes, and chemical reactions that are typically expressed in terms of slight preferences for either the lighter or the heavier isotope of an element. As a result, natural systems offer a rich spectrum of systematic natural abundances of stable isotopes (Faure & Mensing, 2004). Isotopic fractionation along physical and (bio)chemical processes can be controlled kinetically or be based on equilibrium conditions. Biochemical syntheses of lipids, carbohydrates, proteins, etc. rely on different low-molecular organic source compounds ('building blocks'), enzymes, and reaction pathways. Different biochemical heritage is reflected in contrasting isotopic compositions. For examples, organic hydrogen in lipids tends to be systematically depleted in deuterium relative to organic hydrogen in other compound classes (Sessions et al., 1999). Moreover, various types of biological tissues are influenced or even dominated by certain biochemical compound classes that result in distinct isotopic characteristics of entire tissue types. Some tissue types or compound classes within tissues can exhibit enhanced turnover rates, for example lipid reserves during times of reduced food availability. Half of the organic carbon in quail muscle and bone collagen was turned over within 12.4 and 173.3 days, respectively, indicating that bone collagen holds a relatively long-term biochemical signal (Hobson & Clark, 1992).

4.2 Carbon isotopes

The main source of carbon for terrestrial autotrophic life is atmospheric carbon dioxide CO_2 , whereas marine autotrophs typically rely on dissolved CO_2 and bicarbonate ions (HCO_3^-). On average these two global environments with contrasting inorganic carbon pools express $\delta^{13}\text{C}$ values of -7.5 and +1.5‰, respectively. The isotopic difference permeates from primary producers to higher levels of food chains, although the effect is often obfuscated by additional carbon isotope fractionation mechanisms superimposing stronger isotopic variations (Hayes, 2001; Lee-Thorp et al., 1989; van Klinken, 1991). The uptake of inorganic carbon by autotrophs discriminates more or less strongly against ^{13}C depending on the biochemical mode of photosynthesis. Most plants utilize the Calvin (C3) cycle and consequently express $\delta^{13}\text{C}$ values around -26‰. A smaller group of plants employs the C4 pathway, whereby CO_2 molecules are first fixed in a more enclosed system to reduce evapotranspiration of water. C4 plants discriminate less against ^{13}C and have average $\delta^{13}\text{C}$ values of -12‰ (B.N. Smith & Epstein, 1971). The carbon stable isotope ratio in heterotrophs is therefore an important dietary

indicator discriminating between corn-based C4 diets and rice and wheat-based C3 diets (Tieszen et al., 1983). Marine algae utilize the Calvin cycle and, due to the relative ^{13}C -enrichment of dissolved CO_2 and bicarbonate ions in seawater, typically express less negative $\delta^{13}\text{C}$ values (Fry et al., 1982). Additional fractionations occur between and within each food chain member. Consequently, from primary producers, to herbivores, to carnivores, to decomposers, each successive trophic level experiences approximately 1‰ ^{13}C depletion (Ambrose & DeNiro, 1986; Schoeninger et al., 1985; Schoeninger & DeNiro, 1984).

4.3 Nitrogen isotopes

Nitrogen is incorporated into biomolecules either through direct nitrogen fixation from air (e.g., in legumes in symbiosis with nitrogen-fixing bacteria), from ammonium or nitrate in soil water, or from recycled organic nitrogen from soil (Lee-Thorp, 2008; Yakir & DeNiro, 1990). There is negligible isotope fractionation during nitrogen fixation from air (Delwiche & Steyn, 1970). Small isotope fractionations during uptake of ammonia and nitrate by autotrophs are typically dwarfed by larger isotopic variance among natural and industrial sources of ammonium and nitrate (e.g., fertilizers). Similar to carbon isotopes, the nitrogen stable isotope ratio $^{15}\text{N}/^{14}\text{N}$ in biomass increases with trophic level. The preferential retention of ^{15}N -enriched organic nitrogen in biomass is isotopically balanced by the excretion of ^{15}N -depleted waste, e.g. urea. An increase in $\delta^{15}\text{N}$ of 2 to 6‰ per trophic level has been recorded both in terrestrial and marine food webs (DeNiro & Epstein, 1981; Minagawa & Wada, 1984; Rau, 1982). Nitrogen stable isotope ratios in soils, plants and animals are also indirectly related to precipitation and atmospheric relative humidity (Pate & Janson, 2007). The highest plant $\delta^{15}\text{N}$ values are found in arid environments, and the lowest ones at high elevations and in more humid forests (Ambrose, 1991; Handley et al., 1999; Heaton, 1987).

4.4 Applications of carbon and nitrogen isotopes

Bone collagen has been used extensively in an archaeological context for paleodietary and paleoenvironmental reconstructions based on carbon and nitrogen stable isotope ratios (e.g., Ambrose, 1991; Ambrose & DeNiro, 1989; Chisholm et al., 1982; DeNiro & Epstein, 1978, 1981; Huelsemann et al., 2009; Petzke & Lemke, 2009; Walker & DeNiro, 1986; Walter & Leslie, 2009). The reliability of archaeologically recovered bone collagen for stable isotope analyses should be established by testing for contamination by allochthonous (i.e. foreign) compounds that may be adsorbed or covalently linked to collagen, and by evaluating collagen degradation with chemical methods. Collagen extraction should utilize standardized procedures to ensure comparability of results. Deteriorated collagen becomes increasingly soluble (gelatinous). Degradation has been evaluated by quantifying the loss of nitrogen from bone. More than 95% of nitrogen in fresh bone is organic nitrogen in collagen (Collins et al., 2002).

5. Physiological origin of isotopic signals in collagen

Amino acid synthesis in heterotrophs primarily relies on dietary protein rather than on lipids or carbohydrates (Schwarcz, 2000), and thus the isotopic composition of the resulting new collagen is related more to dietary protein rather than to bulk diet. Trophic

recycling of dietary biomass into new live biomass is always partial and thus subject to isotope fractionation. Newly generated amino acids in heterotrophs are enriched in ^{13}C and ^{15}N relative to bulk diet (Howland et al., 2003). More specifically, glycine is enriched in ^{13}C and ^{15}N relative to bulk diet and was found to be directly integrated from food to bone collagen (Hare et al., 1991). Glycine constitutes about 1/3 of all amino acids in collagen and therefore strongly influences ^{13}C and ^{15}N - abundances in bone collagen. Carnivores rely on a protein-rich diet and produce new biomass primarily from dietary amino acids, although the enzymes required for *de novo* amino acid synthesis are present (Gannes et al., 1998). Bone collagen, muscle (meat) and apatite were analyzed for a set of modern southern African herbivores and carnivores (Lee-Thorp et al., 1989). The isotopic analyses showed ^{13}C enrichment in bone collagen, apatite and muscle, and ^{13}C depletion in lipids. Difference in $\delta^{13}\text{C}$ values between herbivores and carnivores indicates a trophic effect, which for carbon in bone collagen is 2.5-3‰ (Fig. 2).

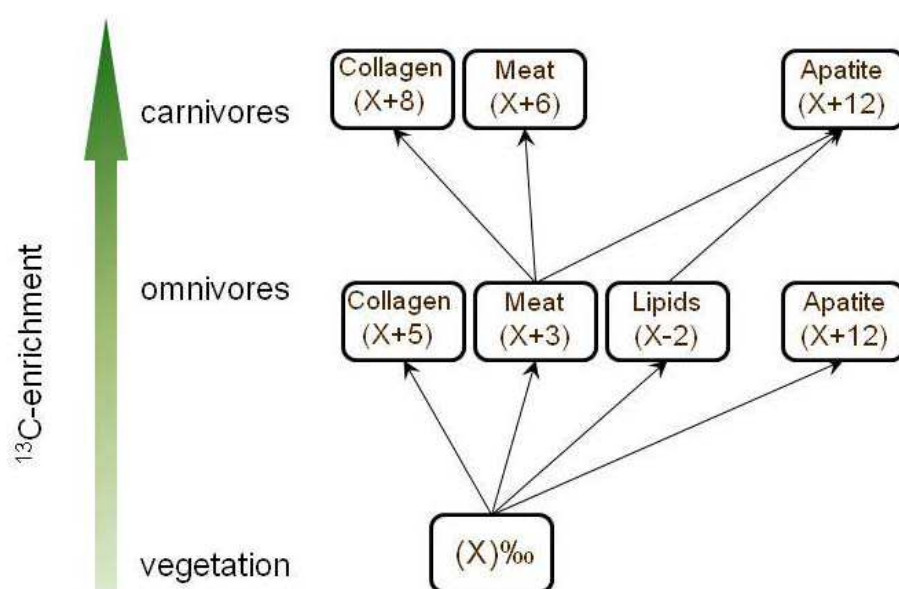

Fig. 2. Foodweb model for southern African herbivores and carnivores representing $\delta^{13}\text{C}$ enrichment/depletion from the baseline (X) $\delta^{13}\text{C}$ value for vegetation (adapted from Lee-Thorp, 1989).

Balzer et al. (1997) experimentally degraded modern bone collagen in laboratory conditions by inoculating bone with soil bacteria. Microbial biodegradation over 8 to 18 months caused isotopic shifts in $\delta^{13}\text{C}$ and $\delta^{15}\text{N}$ values by -2.9 and +5.8‰, respectively, due to altered amino acid profiles and fractionation during peptide bond cleavage (Balzer et al., 1997). The isotopic composition of bulk collagen is the weighted average of the isotopic values of individual participating amino acids that collectively span much wider isotopic ranges and contain far more detailed isotopic information than bulk stable isotope ratios. The high concentration of glycine in collagen together with glycine's systematic ^{13}C -enrichment relative to proline, hydroxyproline and glutamic acid even translates into a relative ^{13}C -enrichment of bulk collagen relative to the entire body (van Klinken, 1991). Decomposition and diagenesis of bone collagen following burial, during exposure to forest fire, or via cooking and roasting by humans may in extreme cases affect bone collagen carbon and nitrogen isotopic values (DeNiro et al., 1985). Similar limitations will need to be considered

when measuring hydrogen isotopes in collagen for archaeological and forensic purposes using fossil or otherwise aged materials.

6. Hydrogen stable isotopes in bone collagen

6.1 D/H ratios in environmental water relate to D/H of organic matter

The ratio of hydrogen's two stable isotopes deuterium (^2H , traditionally abbreviated as D) and protium (^1H , here abbreviated as H) in precipitation or meteoric water shows geographic directional and altitudinal trends. Meteoric water is generally the "heaviest" (i.e. D-enriched) in equatorial regions close to warm oceans that are recharging atmospheric moisture. As air masses travel towards higher latitudes and/or gain altitude, successive loss of water during precipitation depletes the remaining atmospheric moisture in deuterium and results in progressively "lighter" (i.e. D-depleted) rain and snow (e.g., Bowen et al., 2005; van der Veer et al., 2009; Fig. 3).

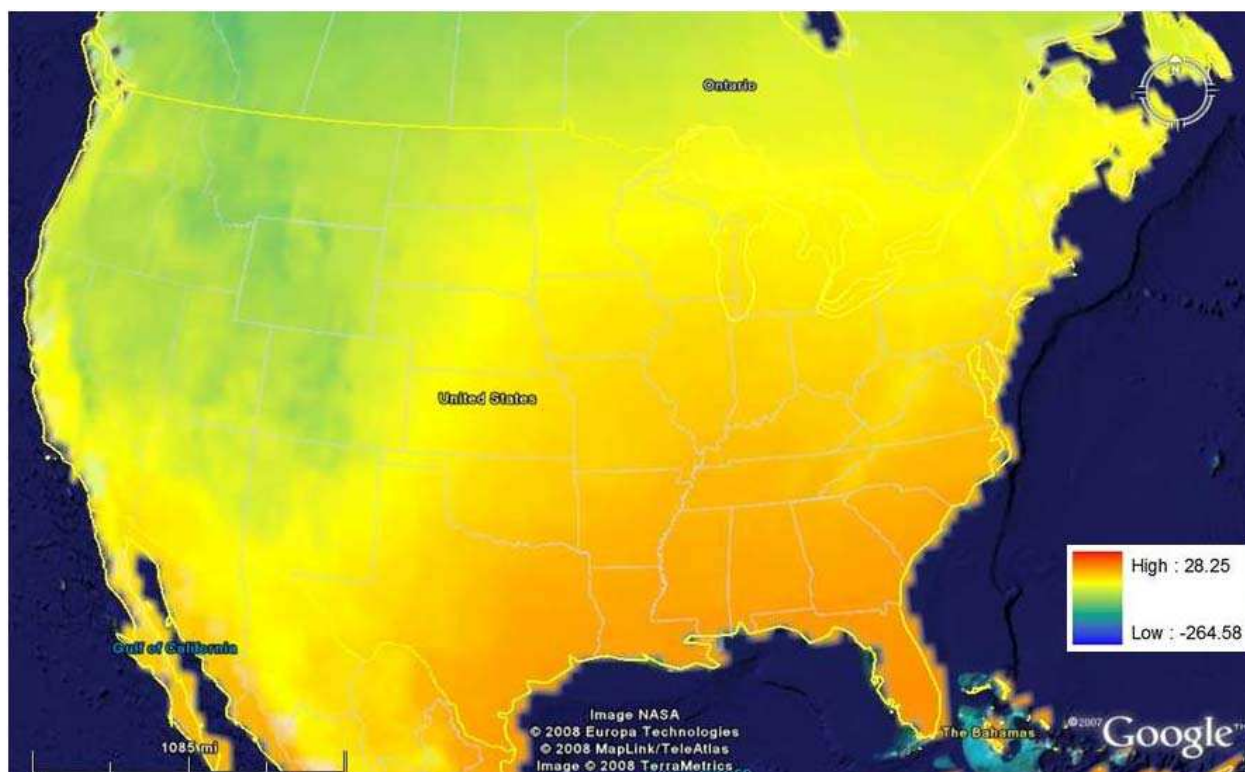

Fig. 3. Map of North America showing a general North-Northwest spatial trend in precipitation stable hydrogen values across the continent.

Hydrogen from water is the direct source of almost all organic hydrogen in tissues of autotrophs, which therefore carry the isotopic signal of environmental water, with the caveat that physical and biochemical isotope fractionations further modulate D/H ratios of individual biochemicals throughout the reaction chains of biosynthesis (e.g., Hayes, 2001). The cellulose and lipids of autotrophs (e.g., preserved in tree rings and as biomarkers in sediments) are valuable substrates in paleoclimatology for paleoenvironmental reconstruction because their organic hydrogen can be isotopically traced directly to environmental water. Heterotrophic use of autotrophic biomass and

passage of organic hydrogen along the food chain progressively introduces metabolic isotope fractionations, mixing of isotopically different organic hydrogen pools, and also offers opportunities for drinking water to isotopically affect newly biosynthesized faunal biomass. Although not all contributing factors can be deconvoluted, experience has shown that careful empirical examination of the hydrogen stable isotopic signal in animal tissues can provide a sound basis for characterizing and constraining the life history and geographic origin of heterotrophs (Hobson et al., 1999; Meehan et al., 2001). In large heterotrophic animals, such as many vertebrates, the complexity of $\delta D_{\text{organic}}$ signals is enhanced because (i) animals can migrate, (ii) animals can change their diet during their life history, and (iii) different species may occupy different levels of an ecosystem's food chain (e.g., Bowen et al., 2009; Farmer et al., 2008; Solomon et al., 2009). The $\delta D_{\text{organic}}$ values of a compound or compound class within an individual animal may vary among different tissues according to when those tissues were biosynthesized. Seasonal, geographic, and other variables during the lifetime of an animal may thus leave an isotopic record (Tuross et al., 2008). For example, the collagen of tooth dentine in sheep and goats records seasonal isotopic changes in precipitation, temperature, and diet because dentine is deposited incrementally throughout the animal's life. $\delta D_{\text{dentine}}$ values from successive growth layers in teeth, when paired with tooth mineral-based $\delta^{18}\text{O}$ values from the same layers, can resolve seasonal climatic changes in temperature and humidity (Kirsanow et al., 2008). Outstanding ecological insight has been gained from $\delta D_{\text{keratin}}$ values in feathers from migrating and non-migrating birds in terms of migration patterns (e.g., Chamberlain et al., 1997; Hobson, 1999) and bird habitats (e.g., Hobson et al., 2003). Similar to collagen, keratin also is a proteinaceous biopolymer, but with prominent cross-linking by sulfur bridges to increase rigidity.

In contrast to lipids where almost all organic hydrogen is chemically strongly bound directly to carbon atoms, the analytical access to precise hydrogen stable isotope ratios in collagen has been made difficult by the fact that some organic hydrogen atoms are weakly bonded and can rapidly exchange when in contact with hydrogen from body and environmental water. As a consequence, the pool of isotopically exchangeable organic hydrogen is unable to preserve a memory of biosynthesis. Exchangeable hydrogen is also called "labile hydrogen" and is primarily located in functional groups like -OH, -COOH, -NH₂, and some specific carbon-linked positions (Schimmelmann et al., 2006). On average ~20% of total organic hydrogen in collagen is exchangeable (Cormie et al., 1994b). Collagens and other biopolymers also contain some potentially exchangeable hydrogen that is deeply embedded in macromolecules' three-dimensional matrix. Shielding from water and other chemical hydrogen donors makes this pool of organic hydrogen essentially non-exchangeable (Fig. 4). However, solubilization of collagen during sample preparation may partially unravel the tertiary polyproteinaceous structure and expose previously shielded hydrogen positions to water.

Exchangeable organic hydrogen can be chemically eliminated from carbohydrates, such as cellulose, by esterification of hydroxy groups with nitric acid (i.e. "nitration"). However, collagen and other chemically more complex organic compounds and bulk tissue require a different approach whereby exchangeable hydrogen is equilibrated, and thus isotopically controlled, with water vapors of known isotopic compositions (Sauer et al., 2009; Schimmelmann, 1991; Wassenaar & Hobson, 2000).

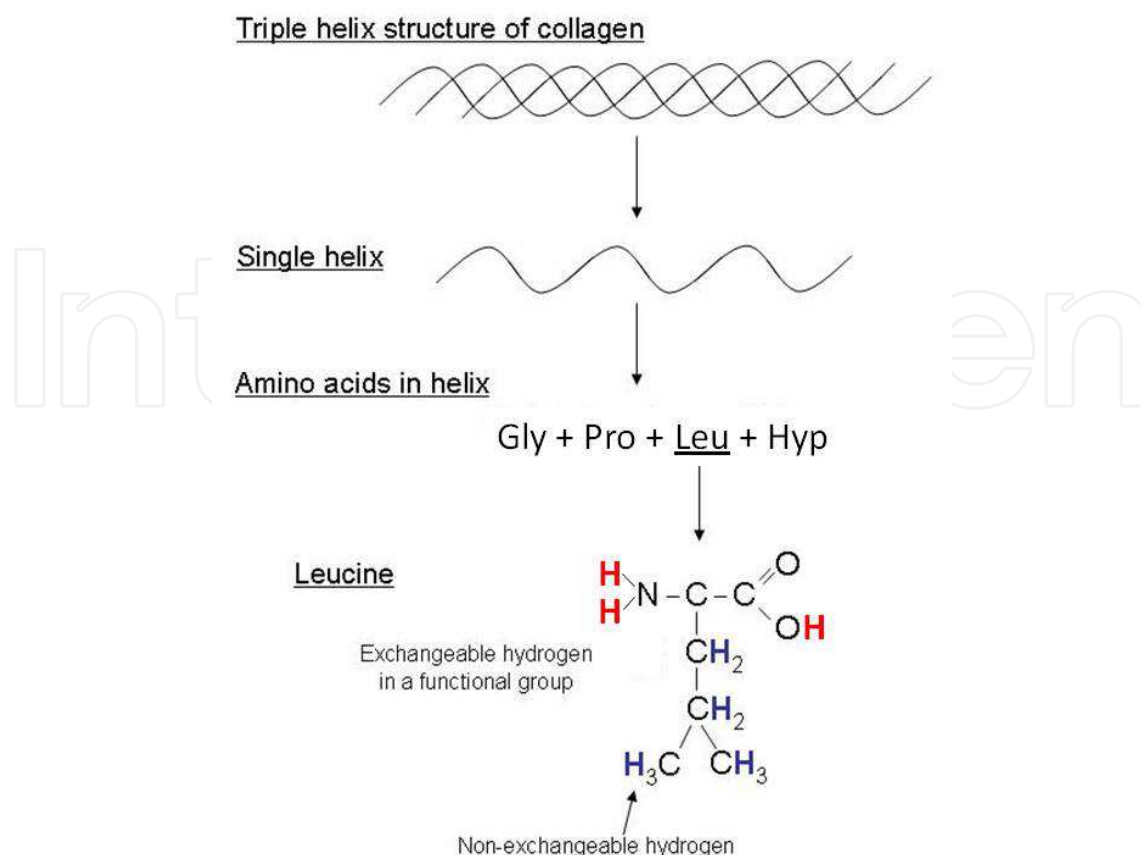

Fig. 4. Helical structure of collagen, typical amino acid sequence within a collagen strand, and exchangeable versus non-exchangeable hydrogen atoms in an individual leucine molecule (Gly - glycine, Pro - Proline, Leu - leucine, Hyp - hydroxyproline).

6.2 Hydrogen isotopic relationship between modern bone collagen and precipitation

The hydrogen stable isotope ratio of precipitation influences the δD values of bulk hydrogen in collagen more strongly in some species than in others. Cormie et al. (1994a) reported an exceptionally strong linear correlation with $R^2 = 0.92$ between both parameters (in a study of 62 white tailed and mule deer from 48 locations in North America when the effect of relative humidity was taken into account using a correction based on collagen $\delta^{15}N$). Our recent preliminary δD_n values of non-exchangeable hydrogen in bone collagen from white-tailed deer and mule deer from locations across the United States suggest a less straightforward relationship, although the data confirm that precipitation is a major factor in determining δD_n in deer (Fig. 5).

However, some of our deer individuals from the arid Joshua Tree National Park in California indicate unusual D-enrichment. This may derive from evapotranspiration in local plants that were part of the diet of the deer and/or in the body fluids of the animals themselves, as is expected in extremely dry environments (Cormie et al., 1994c; Bowen et al., 2005). Deer occupy an ecological niche that is relatively simple from the perspective of hydrogen, as their diet consists of leafy vegetation and their water is obtained from surface waters (lakes and streams) that in many cases have δD values closely representing mean annual precipitation. In contrast, omnivorous and carnivorous animals consume more diverse diets with more widely varying

δD values. Smaller animals and especially those occupying particular niches (e.g., shrews, bats) have higher turnover rates of hydrogen in their bodies. They also exploit smaller pools of water and sources of food which can have isotopic ratios that differ strongly from mean annual precipitation. Accordingly, the hydrogen isotopic relationship of bone collagen and environmental water is strongly species-specific. Using samples from freshly killed animals collected in the field, isotopic calibration studies pose a technical challenge because body water (e.g., from blood) can be collected only after death, but the δD of body water may have varied through the animal's lifespan.

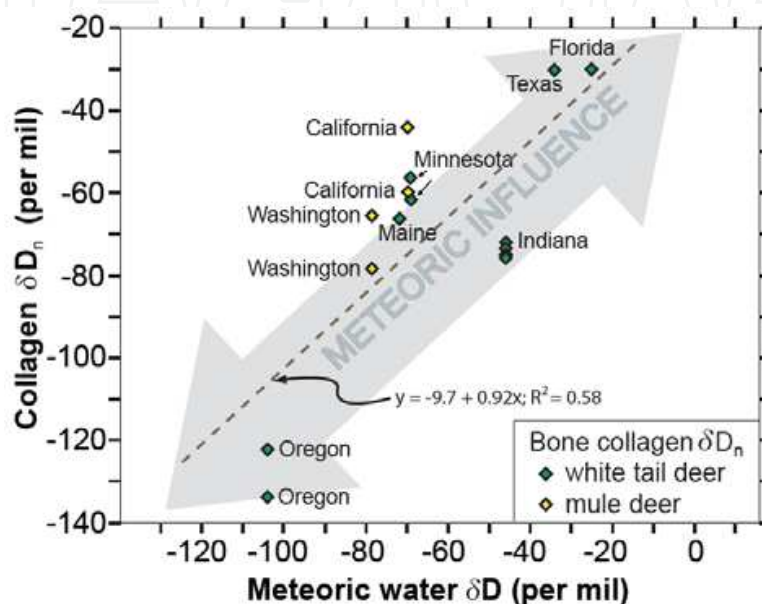

Fig. 5. δD_n of non-exchangeable hydrogen from bone collagen: Pilot data from field-collections of white tail and mule deer collected across the United States.

6.3 D/H comparison between modern and fossil bone collagen

The hydrogen isotope ratio of geochemically preserved and dated fossil bone collagens has value for paleoclimatic reconstructions (Cormie et al., 1994c; Hoppe, 2009). However, as previously stated for carbon and nitrogen, meaningful hydrogen isotopic analysis of bone collagen hinges on the prerequisite that collagen has not suffered any significant diagenetic isotopic changes (Balzer et al., 1997; Lee-Thorp, 2008). Leyden et al. (2006) compared $\delta D_{\text{collagen}}$ values from 7 modern and 52 fossil bison bones from Canada with ages of up to 10,000 years. The problem of exchangeable hydrogen in collagen was addressed by equilibration in water vapors (Wassenaar & Hobson, 2000). Leyden et al. (2006) found that $\delta D_{\text{collagen}}$ in modern and fossil bones followed the same geographic gradient as modern δD_{water} in Canadian precipitation. Furthermore, consistency between changes in $\delta D_{\text{collagen}}$ through time and independent evidence for regional Holocene climatic changes corroborates the value of $\delta D_{\text{collagen}}$ as a paleoenvironmental proxy.

6.4 Effect of trophic level on stable isotope ratios of bone collagen

δD values of amino acids from autotrophs are directly related to the δD_{water} in the cellular and intercellular water. As food is metabolized, part of its organic hydrogen has an opportunity to

exchange isotopically with body water before organic components are incorporated into new biomass. Trophically “recycled” amino acids from ingested food do not exchange all of their hydrogen. Most of the hydrogen that is bonded covalently to carbon does not readily exchange with water as long as the biomolecule is chemically unaltered. Energetic transitions may foster limited isotopic exchange, e.g. during *post-mortem* racemization, but racemization rates are sufficiently slow that negligible effects on δD are expected on young bone samples that have never experienced elevated temperatures. Most of the carbon-bound hydrogen in collagen is essentially “non-exchangeable” over thousands of years at low temperature (Sessions et al., 2004; Schimmelmann et al., 2006) and is able to maintain an isotopic memory of trophic input. Because all animals are heterotrophic with a limited ability to synthesize amino acids, their collagen (and therefore the pool of H contained in collagen) represents a varying mixture of dietary biomass from lower levels in the food chain and newly synthesized amino acids. This upward-cascading flow of organic hydrogen from one trophic level to the next introduces successive isotopic patterns that relate to specific ecological and trophic situations. Although the resulting isotopic relationships can be complex, the analytically accessible isotope patterns can be empirically calibrated with modern faunal analogs and thus be used to constrain paleodiet and paleoenvironments.

This suggests (i) that isotopic patterns of bone collagens of carnivores and herbivores may differ systematically and (ii) the hydrogen isotopic composition of drinking water may be less important for collagen in carnivores than in herbivores (Pietch et al., 2011). In other words, the hydrogen isotopic composition of bone collagen should be sensitive to the amount and dietary importance of ingested protein, which should offer analytical opportunities to reconstruct aspects of diet and trophic structure.

Consumption of lower-trophic level biomass by a higher-level heterotrophic organism offers an opportunity to isotopically fractionate the pools of atoms that are utilized to build new biomass. Enrichment in ^{13}C and ^{15}N with increasing trophic level in bone collagen has been documented extensively. Similarly, trophic D-enrichment has been found in chitin (i.e. an aminosugar-based biopolymer found in arthropod exoskeletons; Schimmelmann & DeNiro, 1986). More recently, a systematic increase in δD values of vertebrate bone collagen with higher trophic levels has been documented (Birchall et al., 2005; Reynard & Hedges, 2008; Topalov et al., 2009). Non-exchangeable hydrogen in collagen from herbivores is generally D-depleted relative to environmental water, and the observed range of δD_n is smallest. Carnivores show the highest and most variable δD_n values, whereas omnivores fall into a range between herbivores and carnivores (Fig. 6). Exceptions to this trend, such as small insectivores with occasional large D-enrichment (e.g., bats and shrews) may reflect special cases related to small body sizes and/or unusually high metabolic rates.

The trophic structure of ecosystems has traditionally been explored with nitrogen stable isotopes. A correlation between $\delta^{15}N$ and δD values of bone collagens from 19 aquatic and terrestrial species, including fish, birds and mammals, corroborates the value of collagen δD for trophic structural investigations (Birchall et al., 2005). δD values of collagens from both terrestrial and marine organisms at similar trophic levels were comparable, whereas the trophic signal in marine $\delta^{15}N$ values was relatively weak. Collagens from carnivores and piscivores were D-enriched by ca. 90‰ relative to herbivores and omnivores. An increase in bone collagen δD values by 10 to 30‰ from herbivores to omnivores to humans was observed by Reynard & Hedges (2008) (Fig. 7). The authors reduced the isotopic variability among

faunal individuals by averaging data from 10 to 15 samples per species. Our recent preliminary data corroborate Birchall et al.'s (2005) conclusions by demonstrating a strong trophic signal with generally good separation between herbivores, omnivores, and carnivores.

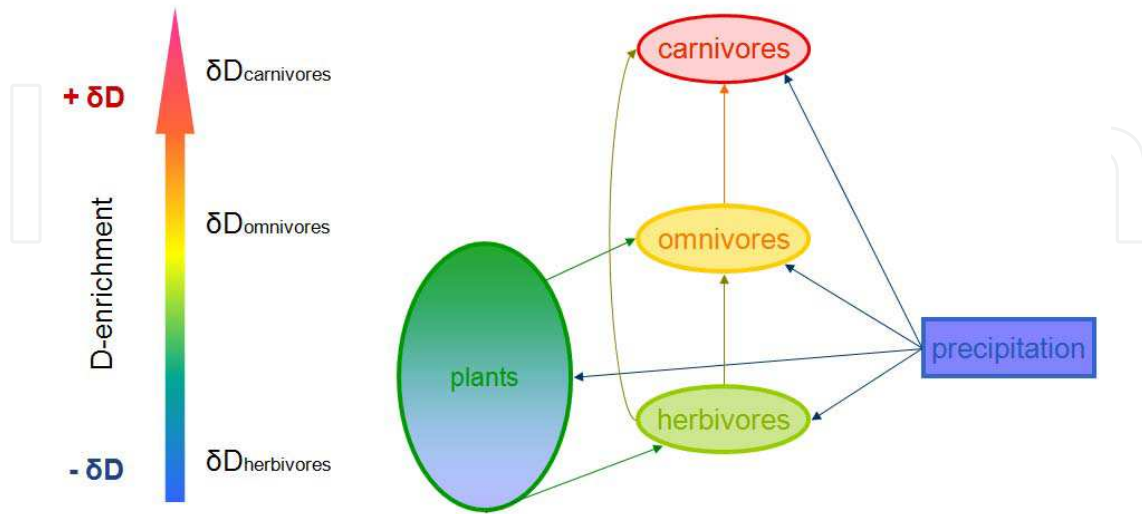

Fig. 6. Deuterium enrichment through a conceptual trophic chain.

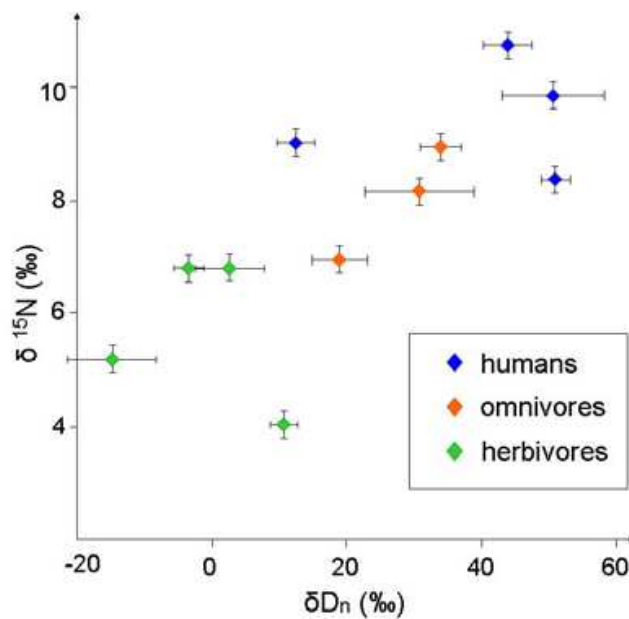

Fig. 7. $\delta^{15}N$ vs. δD mean values for bone collagens of herbivores and omnivores including humans from Great Britain, Hungary, Peru and Canada dating from the Neolithic to the mid-15th century AD (adapted from Reynard & Hedges 2008). Error bars indicate one standard error of the mean of 10 to 15 samples per species.

Terrestrial biota is exposed to potentially large seasonal and geographic hydrogen isotopic variability in meteoric and environmental waters that complicates the isotopic influence of both drinking water and diet. In contrast, the global mixing of open ocean waters results in seawaters with a narrow hydrogen isotopic range of only a few permil (Dansgaard, 1964). Consequently, the hydrogen isotopic signal of bone collagen from marine animals should

predominantly reflect diet and be less sensitive to drinking water (Fetcher, 1939; Ortiz, 2001). Evaporative D-enrichment of body fluid during respiration may be limited because air near the water surface has a relatively high humidity. Marine mammals are predators at the top of a long food chain that contains multiple trophic levels of zooplankton, fish, and may even include other marine mammals. Our preliminary data from two populations of California sea lions from the Channel Islands (California, USA) indicate that the variability of collagen δD in adults is comparable to that of terrestrial carnivores from Bloomington, Indiana. This suggests that δD variability in populations is based more on individuality of animals rather than on environmental variability. Bone collagen δD of California sea lions strongly discriminates between D-depleted young pups and relatively D-enriched adult sea lions. Nursing sea lion pups (aged < 12 months), δD_n values typically range around $\delta D = +25\%$, while δD_n values for adults are substantially higher ($\delta D = +70\%$). We interpret this to reflect weaning from a D-depleted, lipid-rich milk diet to a prey-based adult diet.

Our preliminary bone collagen δD values on a wide range of animal species from a small region around Bloomington, Indiana, suggest that higher and more variable δD values are related to small body size and/or the rapid metabolic rate in some small mammals. For example, rapid metabolism and intense respiration likely entails evaporative D-enrichment in body water and greater reliance on drinking water with warm-seasonal bias towards less negative δD . In addition, seasonal changes in diet should more rapidly affect biomass of smaller animals that express rapid turnover of their biomass, including bone collagen. Even though small mammals are homeotherm organisms, their larger ratio of surface to body mass makes them more susceptible to environmental temperature. Smaller warm-blooded animals in cool climates must maintain a high metabolic rate to stay warm. Another consequence of a fast metabolism is a short life span. For example, the Eastern short-tailed shrew can live up to two years, but approximately 80% of the young will not live to the winter. Juvenile bone collagen δD will therefore be in response to summer to fall hydrological and ecological conditions rather than influenced by annual average conditions. Moreover, juveniles may still partially carry a prenatal and lactation-derived δD signal.

7. Methods of stable isotope collagen research

The use of hydrogen isotopes in biomass faces the difficulty that some organic hydrogen atoms are weakly bonded in biomolecules, exchange with hydrogen from water, and thus may lose their original biogenic isotopic information. Exchangeable hydrogen is also called labile hydrogen and occupies chemically functional groups like $-OH$, $-COOH$, $-NH_2$, and some specific carbon-linked positions (Schimmelfmann & al., 2006). Exchangeable hydrogen can be chemically eliminated from a few organic substances, such as cellulose, through the process of 'nitration'. Most chemically more complex biochemicals and bulk tissue require a different approach whereby exchangeable hydrogen is equilibrated, and thus isotopically controlled, with waters of known isotopic compositions. Such equilibrations were traditionally performed off-line in chambers with stationary water vapor (Wassenaar & Hobson, 2000) or in dynamic flow-through conditions (Schimmelfmann, 1991). A remaining problem was the labor-intensive nature of equilibrating organic samples in individual quartz tubes. Here we present a more efficient equilibration approach. Simultaneous steam-equilibration of dozens of collagen and/or other organic samples in an EA carousel with subsequent on-line continuous-flow D/H

measurements via TC/EA is far more efficient than previously available methods. A variety of collagen extraction procedures have been developed following a similar general outline (e.g., Tuross et al., 1988, DeNiro & Weiner, 1988).

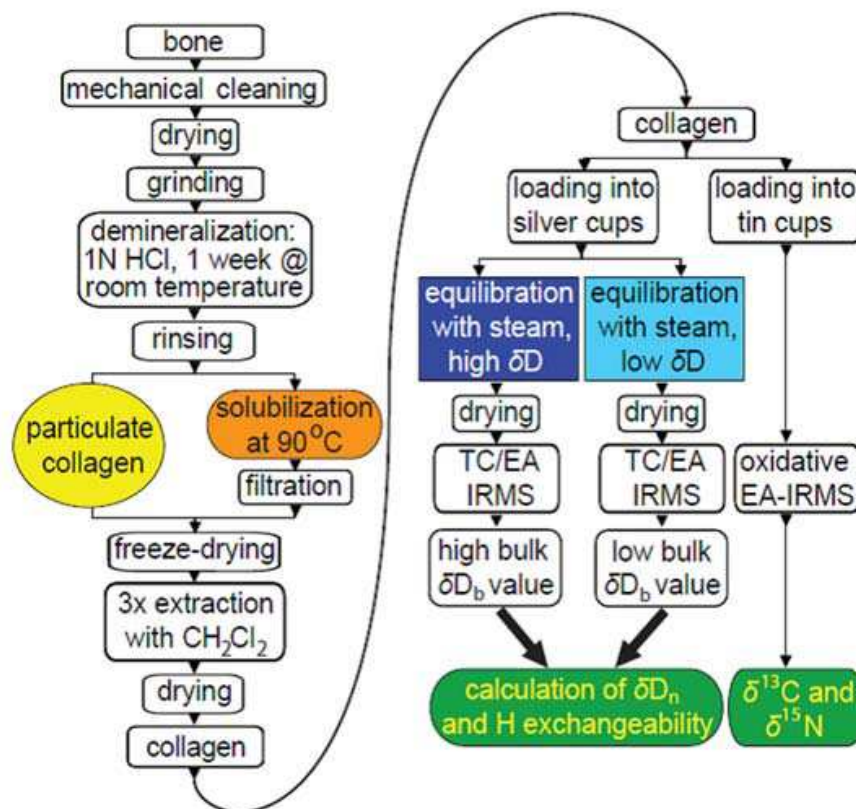

Fig. 8. The overall procedures are separated into (left) preparation of bone collagen and (right) determination of stable isotope ratios using isotope ratio mass spectrometry (IRMS). Yellow and orange fields indicate two fundamentally different approaches that need to be tested for hydrogen isotopic repercussions using collagens with different degrees of preservation and diagenetic overprinting. Light blue and dark blue fields indicate key elements of dual water vapor (steam) isotopic equilibration of exchangeable hydrogen in twin aliquots of every collagen.

7.1 Water vapor isotopic equilibration of exchangeable hydrogen in collagen

Recently we developed a fast and economical analytical procedure to isotopically equilibrate and thus control the isotopic composition of exchangeable hydrogen in bone collagen with isotopically known water vapors (Sauer et al., 2009). In brief, our method allows for reduced sample sizes of 0.3 to 1mg, depending on the hydrogen content of organic substrates. The isotopic uncertainty from exchangeable hydrogen was reduced via equilibration with isotopically known water vapors and subsequent mass-balance calculations arriving at the δD_n of non-exchangeable hydrogen in collagen. The samples in silver capsules are loaded into an EA carousel and closed off into an aluminum equilibration chamber (Fig. 9). Samples are allowed to equilibrate with steam for at least 6 hours, dried in a flow of dry N₂ and quickly transferred to the autosampler, followed by immediate flushing of the loaded autosampler with helium.

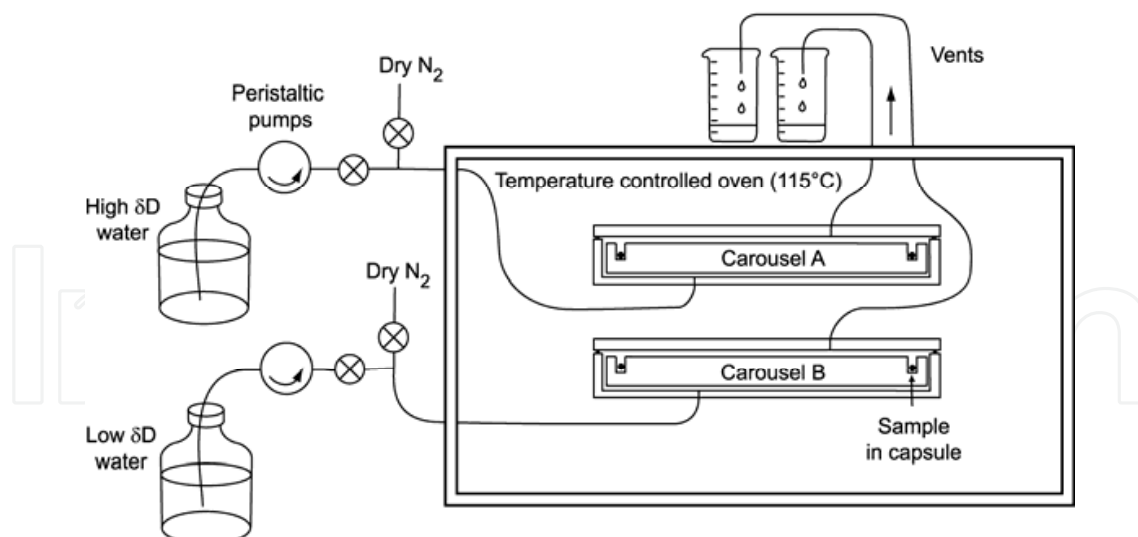

Fig. 9. Schematic of water vapor equilibration apparatus featuring carousels that hold up to 49 samples in crimped silver cups (from Sauer et al., 2009).

A reductive TC/EA (i.e. thermal conversion elemental analyzer) is used for D/H determination. The resulting δD isotopic difference between pairs of equilibrated collagens is used to calculate the percentage H_{ex} of exchangeable hydrogen in total hydrogen. All collagens are chemically similar and should have comparable H_{ex} values, which serves as quality control. In case of collagens prepared in our lab, the hydrogen exchangeability averages $22\% \pm 2\%$. Finally, collagen $\delta^{13}C$ and $\delta^{15}N$ is determined to better constrain the ecology and trophic positions of animals. For additional quality control (e.g., Lee-Thorp, 2008), the atomic C/N ratio of collagens is calculated.

8. Outlook to future isotopic research on bone collagen

The recording of environmental conditions by stable isotope ratios in biological substrates is a proven concept, but the details are more complex than anticipated by the simplistic expression “you are what you eat” (DeNiro & Epstein, 1978) “plus or minus a few permil” (Rundel et al., 1988). More laboratory-constrained experiments are needed to deconvolute and constrain the complex pathways of hydrogen, carbon and nitrogen isotopes in biochemical substrates. Analytical methods now exist to add oxygen stable isotopes to the arsenal. There is a great need for field-based research of modern non-migrating animal populations that can serve as analogs for animals in archaeological and forensic investigations. We need to assess individual isotopic variations within populations that are caused by diet, home range size, and migratory habits, as well as the causes of isotopic variations within an individual.

A promising new frontier in collagen stable isotope research is the determination of compound-specific isotope ratios of individual amino acids after hydrolysis of the biopolymer. The underlying analytical methods have long been established for carbon and nitrogen stable isotope ratios. Following hydrolytic depolymerization of collagen in acid, the free amino acids must be chromatographically separated via gas or liquid chromatography prior to combustion to carbon dioxide and nitrogen that can be measured mass-spectrometrically to yield $\delta^{13}C$ and $\delta^{15}N$ values (Chikaraishi et al., 2007). Gas chromatography (GC) requires that polar functional groups of free zwitterionic amino acids

are first derivatized to yield less polar compounds that can move together with helium carrier gas through a capillary GC column. Derivatizing agents typically contain additional carbon that adds its isotopic influence to the measured analytes and must be accounted for by applying mass-balance corrections. Current analytical efforts seem to have succeeded in applying the same principle toward the measurement of compound-specific amino acid D/H ratios (e.g., Chikaraishi et al., 2003).

The stable isotope ratios of bulk collagen represent weighted averages of the stable isotope ratios of participating amino acids. Much additional isotopic information can be obtained from individual amino acids than from bulk collagen. Amino acids collectively express far larger isotopic ranges than bulk collagen. Greatly enhanced trophic information can be gleaned from the isotopic differences between essential and non-essential amino acids in collagen from heterotrophs, since only essential amino acids express a direct and unambiguous heritage from diet. We can expect that many of the shortcomings and ambiguities of stable isotope ratios in bulk bone collagen will be mitigated or overcome by novel approaches that yield compound-specific isotope ratios of individual amino acids from collagen.

9. References

- Ambrose, S.H. (1991). Effects of diet, climate and physiology on nitrogen isotope abundances in terrestrial foodwebs. *Journal of Archaeological Science*, Vol. 18, 293-317. ([http://dx.doi.org/10.1016/0305-4403\(91\)90067-Y](http://dx.doi.org/10.1016/0305-4403(91)90067-Y))
- Ambrose, S. H., & DeNiro, M. J. (1986). The isotopic ecology of East African mammals. *Oecologia*, 69: 395-406.
- Ambrose, S.H. & DeNiro, M.J. (1989). Climate and habitat reconstruction using stable carbon and nitrogen isotope ratios of collagen in prehistoric herbivore teeth from Kenya. *Quaternary Research* 31, 407-422.
- Balzer, A., Gleixner, G., Grupe, G., Schmidt, H.-L., Schramm, S., & Turban-Just, S. (1997). In vitro decomposition of bone collagen by soil bacteria: the implications for stable isotope analysis in archaeometry. *Archaeometry* 39 (2), 415-429. (<http://dx.doi.org/10.1111/j.1475-4754.1997.tb00817.x>)
- Babraj, J., Cuthbertson, D.J., Rickhuss, P., Meier-Augenstein, W., Smith, K., Bohé, J., Wolfe, R.R., Gibson, J.N., Adams, C. & Rennie, M.J. (2002). Sequential extracts of human bone show differing collagen synthetic rates. *Biochemical Society Transactions*, Vol. 30, pp. 61-65.
- Bell, L.S., Skinner, M.F., & Jones, S.J. (1996). The speed of post mortem change to the human skeleton and its taphonomic significance. *Forensic Science International*, Vol. 82, pp. 129-140.
- Birchall J., O'Connell, T.C., Heaton, T.H.E., & Hedges, R.E.M. (2005). Hydrogen isotope ratios in animal body protein reflect trophic level. *Journal of Animal Ecology*, 74, 877-881. (<http://dx.doi.org/10.1111/j.1365-2656.2005.00979.x>)
- Bocherens, H., Billiou, D., Mariotti, A., Patou-Mathis, M., Otte, M., Bonjean, D., & Toussaint, M. (1999). Palaeoenvironmental and paleodietary implications of isotopic biogeochemistry of Last Interglacial Neanderthal and mammal bones in Scladina Cave (Belgium). *Journal of Archaeological Science*, Vol. 26, pp.599-607.
- Bowen, G.J., L.I. Wassenaar, & Hobson, K.A. (2005). Global application of stable hydrogen and oxygen isotopes to wildlife forensics. *Oecologia*, Vol. 143, pp. 337-348. (<http://dx.doi.org/10.1007/s00442-004-1813-y>)

- Chamberlain, C.P., Blum, J.D., Holmes, R.T., Feng, X., Sherry, T.W. & Graves, G.R. (1997). The use of isotope tracers for identifying populations of migratory birds. *Oecologia*, Vol. 109, No. 1, pp. 132-141. (<http://dx.doi.org/10.1007/s004420050067>)
- Chikaraishi, Y. & Naraoka, H. (2003). Compound-specific δ - ^{13}C analyses of n-alkanes extracted from terrestrial and aquatic plants. *Phytochemistry*, Vol. 63, pp. 361-371.
- Chikaraishi, Y., Kashiyama, Y., Ogawa, N.O., Kitazato, H., & Ohkouchi, N. (2007). Metabolic control of nitrogen isotope composition of amino acids in macroalgae and gastropods: Implications for aquatic food web studies. *Marine Ecology Progress Series*, Vol. 342, pp. 85-90.
- Child, A.M. (1995). Microbial taphonomy of archaeological bone. *Studies in Conservation*, Vol.40, pp.19-30.
- Chisholm, B.S., Nelson, D.E., & Schwarcz, H.P. (1982). Stable-carbon isotope ratios as a measure of marine versus terrestrial protein in ancient diets. *Science*, Vol. 216 No. 4550, pp. 1131-1132. (<http://dx.doi.org/10.1126/science.216.4550.1131>)
- Collins, M. J., Riley, M., Child, A. M., & Turner-Walker, G. (1995) A basic mathematical simulation of the chemical degradation of ancient collagen, *Journal of Archaeological Science*, Vol.22, pp. 175-83.
- Collins, M.J., Nielsen-Marsh, C.M., Hiller, J., Smith, C.I., Roberts, J.P., Prigodich, R.V., Weiss, T.J., Csapò, J., Millard, A.R., & Turner-Walker, G. (2002). The survival of organic matter in bone: a review. *Archaeometry*, Vol. 44, No. 3, pp. 383-394. (<http://dx.doi.org/10.1111/1475-4754.t01-1-00071>)
- Coplen, T.B. (1996). New guidelines for reporting stable hydrogen, carbon, and oxygen isotope-ratio data. *Geochimica et Cosmochimica Acta* Vol. 60, No. 17, pp. 3359-3360. ([http://dx.doi.org/10.1016/0016-7037\(96\)00263-3](http://dx.doi.org/10.1016/0016-7037(96)00263-3))
- Coplen, T.B. (2011). Guidelines and recommended terms for expression of stableisotope-ratio and gas-ratio measurement results. *Rapid Communications in Mass Spectrometry*, 25, 2538-2560. DOI: 10.1002/rcm.5129
- Cormie, A.B., Luz, B., & Schwarcz, H.P. (1994a). Relationship between the hydrogen and oxygen isotopes of deer bone and their use in the estimation of relative humidity. *Geochimica et Cosmochimica Acta*, 58, pp. 3439-49. ([http://dx.doi.org/10.1016/0016-7037\(94\)90097-3](http://dx.doi.org/10.1016/0016-7037(94)90097-3))
- Cormie, A.B., Schwartz, H.P., & Gray, J. (1994b). Determination of the hydrogen isotopic composition of bone collagen and correction for hydrogen exchange. *Geochimica et Cosmochimica Acta*, Vol. 58, pp. 365-375.
- Cormie, A.B., Schwartz, H.P., & Gray, J. (1994c). Relation between hydrogen isotopic ratios of bone collagen and the rain. *Geochimica et Cosmochimica Acta* 58, pp. 377-391. ([http://dx.doi.org/10.1016/0016-7037\(94\)90471-5](http://dx.doi.org/10.1016/0016-7037(94)90471-5))
- Dansgaard, W. (1964). Stable isotopes in precipitation, *Tellus*, Vol. 16, pp. 436-468.
- Delwiche, C.C. & Steyn, P.L. (1970). Nitrogen isotope fractionation in soils and microbial reactions. *Environmental Science and Technology*, Vol. 4, pp. 929-935.
- DeNiro, M.J., & Epstein, S. (1978). Influence of diet on the distribution of carbon isotopes in animals. *Geochimica et Cosmochimica Acta*, 42, pp. 495-506. ([http://dx.doi.org/10.1016/0016-7037\(78\)90199-0](http://dx.doi.org/10.1016/0016-7037(78)90199-0))
- DeNiro, M.J., & Epstein, S. (1981) Influence of diet on the distribution of nitrogen isotopes in animals. *Geochimica et Cosmochimica Acta*, 45, pp. 341-351. ([http://dx.doi.org/10.1016/0016-7037\(81\)90244-1](http://dx.doi.org/10.1016/0016-7037(81)90244-1))

- DeNiro, M.J., & Weiner, S. (1988). Chemical, enzymatic and spectroscopic characterization of "collagen" and other organic fractions from prehistoric bones. *Geochimica et Cosmochimica Acta* Vol. 52, No. 9, pp. 2197-2206. ([http://dx.doi.org/10.1016/0016-7037\(88\)90122-6](http://dx.doi.org/10.1016/0016-7037(88)90122-6))
- DeNiro, M.J., & Weiner, S. (1988). Chemical, enzymatic and spectroscopic characterization of "collagen" and other organic fractions from prehistoric bones. *Geochimica et Cosmochimica Acta*, Vol.52, pp. 2197-2206.
- Eyre, D.R. (1980). Collagen: molecular diversity in the body's protein scaffold. *Science*, Vol. 207, No. 4437, (March 21, 1980), pp. 1315-1322.
- Farmer, A., Cade, B.S., & Torres-Dowdall, J. (2008). Fundamental limits to the accuracy of deuterium isotopes for identifying the spatial origin of migratory animals. *Oecologia*, Vol. 158, pp. 183-192. (<http://dx.doi.org/10.1007/s00442-008-1143-6>)
- Faure, G. & Mensing, T.M. (2005). *Isotopes: Principles and Applications*. (3rd edition), Wiley, ISBN-10: 0471384372, Hoboken, NJ, USA.
- Fetcher, E.S., Jr (1939). The water balance in marine mammals. *The Quarterly Review of Biology*, Vol. 14, pp. 451-459.
- Fry, B., Lutes, R., Northam, M., Parker, P.L., & Ogden, J. (1982). A ¹³C/¹²C comparison of food webs in Caribbean seagrass meadows and coral reefs, *Aquatic Botany*, Vol. 14, pp. 389-398.
- Gannes, L.Z., Martinez del Rio, C., & Koch, P. (1998). Natural abundance variations in stable isotopes and their potential uses in animal physiological ecology. *Comparative Biochemistry and Physiology - Part A: Molecular & Integrative Physiology*, Vol. 119, No. 3, pp. 725-737. ([http://dx.doi.org/10.1016/S1095-6433\(98\)01016-2](http://dx.doi.org/10.1016/S1095-6433(98)01016-2))
- Gelse, K., Poschl, E., & Aigner, T. (2003). Collagens - structure, function, and biosynthesis. *Advanced Drug Delivery Reviews*, Vol. 55, pp. 1531-1546. (<http://dx.doi.org/10.1016/j.addr.2003.08.00>)
- Handley, L.L., Austin, A.T., Robinson, D., Scrimgeour, C.M., Raven, J.A., Heaton, T.H.E., Schmidt, S., & Stewart, G.R. (1999). The ¹⁵N natural abundance($\delta^{15}\text{N}$) of ecosystem samples reflects measures of water availability. *Australian Journal of Plant Physiology*, Vol. 26, pp.185-199.
- Hare, P.E., Fogel, M.L., Stafford Jr., T.W., Mitchell, A.D., & Hoering, T.C. (1991). The isotopic composition of carbon and nitrogen in individual amino acids isolated from modern and fossil proteins. *Journal of Archaeological Science*, Vol. 18, pp. 211-292. ([http://dx.doi.org/10.1016/0305-4403\(91\)90066-X](http://dx.doi.org/10.1016/0305-4403(91)90066-X))
- Hayes, J.M. (2001). Fractionation of carbon and hydrogen isotopes in biosynthetic processes. In: *Stable Isotope Geochemistry* (J.W. Valley, D.R. Cole, Eds.), *Reviews in Mineralogy and Geochemistry* 43, 225-277. Washington DC: Mineralogical Society of America, 662 pp.
- Heaton, T.H.E. (1987). Isotopic studies of nitrogen in the hydrosphere and atmosphere: a review. *Chemical Geology (Isotope Geoscience)*, Vol. 59, pp. 87-102.
- Hedges, R. E. M., Stevens, R. E., & Koch, P. L. (2006). Isotopes in bone and teeth. In Leng, M. J. (ed.), *Isotopes in Palaeoenvironmental Research*, Springer, pp. 117-146.
- Hedges, R. E. M., Clement, J. G., Thomas, C. D. L., & O'Connell, T. C. (2007). Collagen turnover in the adult femoral mid-shaft: Modeled from anthropogenic radiocarbon tracer measurements. *American Journal of Physical Anthropology*, 133, pp. 808-816.
- Hedges, R. E. M. & Law, I. H. (1989). The radiocarbon dating of bone, *Applied Geochemistry*, Vol. 4, pp. 249-53.

- Hobson, K. A. & Clark, R. G. Assessing Avian Diets Using Stable Isotopes I: Turnover of ^{13}C in Tissues. *The Condor*, Vol. 94, No. 1. (Feb., 1992), pp. 181-188.
- Hobson, K.A., Atwell, L., & Wassenaar, L.I. (1999). Influence of drinking water and diet on the stable- hydrogen isotope ratios of animal tissues. *Proceedings of the National Academy of Sciences*, Vol. 96, 8003-8006.
- Hobson, K.A., Wassenaar, L.I., Mila, B., Lovette, I., Dingle, C., & Smith, T.B. (2003). Stable isotopes as indicators of altitudinal distributions and movements in an Ecuadorian hummingbird community. *Oecologia*, Vol. 136, pp. 302-308. (<http://dx.doi.org/10.1007/s00442-003-1271-y>)
- Hoppe, K.A. (2009). How well do the stable hydrogen isotope ratios of bone collagen from modern herbivores track climatic patterns? 2009 Portland GSA Annual Meeting (18-21 October 2009), *GSA Abstracts with Programs* 41 (7), pp. 311. (http://gsa.confex.com/gsa/2009AM/finalprogram/abstract_166384.htm)
- Howland, M.R., Corr, L.T., Young, S.M.M., Jones, V., Jim, S., Van Der Merwe, N.J., Mitchell, A.D., & Evershed, R.P. (2003). Expression of the dietary isotope signal in the compound-specific $\delta^{13}\text{C}$ values of pig bone lipids and amino acids. *International Journal of Osteoarchaeology*, 13, pp. 54-65. (<http://dx.doi.org/10.1002/oa.658>)
- Huelsemann F., Flenker, U., Koehler, K., & Schaenzer, W. (2009). Effect of a controlled dietary change on carbon and nitrogen stable isotope ratios of human hair. *Rapid Communications in Mass Spectrometry* Vol. 23, pp. 2448-2454. (<http://dx.doi.org/10.1002/rcm.4039>)
- Kirsanow K., Makarewicz, C., & Tuross, N. (2008). Stable oxygen ($\delta^{18}\text{O}$) and hydrogen (δD) isotopes in ovicaprid dentinal collagen record seasonal variation. *Journal of Archaeological Science* Vol. 35, No. 12, pp. 3159-3167. (<http://dx.doi.org/10.1016/j.jas.2008.06.025>)
- Lee-Thorp, J. A., Sealey, J. C. & van der Merwe, N. J. (1989). Stable carbon isotope ratio differences between bone collagen and bone apatite, and their relationship to diet. *Journal of Archaeological Science*, Vol. 16, pp. 585-599.
- Lee-Thorp, J.A. (2008). On isotopes and old bones. *Archaeometry*, Vol. 50, No. 6, pp. 925-950. (<http://dx.doi.org/10.1111/j.1475-4754.2008.00441.x>)
- Leyden, J.J., Wassenaar, L.I., Hobson, K.A., & Walker, E.G. (2006). Stable hydrogen isotopes of bison bone collagen as a proxy for Holocene climate on the Northern Great Plains. *Palaeogeography, Palaeoclimatology, Palaeoecology*, Vol. 239, pp. 87-99. (<http://dx.doi.org/10.1016/j.palaeo.2006.01.009>)
- Lis, G., Wassenaar, L.I., & Hendry, M.J. (2008). High-precision laser spectroscopy D/H and $^{18}\text{O}/^{16}\text{O}$ measurements of microliter natural water samples. *Analytical Chemistry*, Vol. 80, No. 1, pp. 287-293. (<http://dx.doi.org/10.1021/ac701716q>)
- Meehan, T.D., Lott, C.A., Sharp, Z.D., Smith, R.B., Rosenfield, R.N., Stewart, A.C., & Murphy, R.K. (2001). Using hydrogen isotope geochemistry to estimate the natal latitudes of immature Cooper's hawks migrating through the Florida keys. *Condor*, Vol. 103, 11-20. ([http://dx.doi.org/10.1650/0010-5422\(2001\)103\[0011:UHIGTE\]2.0.CO;2](http://dx.doi.org/10.1650/0010-5422(2001)103[0011:UHIGTE]2.0.CO;2))
- Minagawa, M., & Wada, E. (1984). Stepwise enrichment of ^{15}N along food chains: further evidence and the relation between ^{15}N and animal age. *Geochimica et Cosmochimica Acta*, Vol. 48, pp.1135-1140.
- Ortiz, R.M. (2001). Osmoregulation in marine mammals. *The Journal of Experimental Biology*, Vol. 204, 1831-1844.

- Pate, F.D., & Anson, T.J. (2007). Stable nitrogen isotope values in arid-land kangaroos correlated with mean annual rainfall: potential as a palaeoclimatic indicator. *International Journal of Osteoarchaeology*, Vol. 18, 317–326.
- Petzke, K.J. & Lemke, S. (2009). Hair protein and amino acid ^{13}C and ^{15}N abundances take more than 4 weeks to clearly prove influences of animal protein intake in young women with a habitual daily protein consumption of more than 1g per kg body weight. *Rapid Communications in Mass Spectrometry*, Vol. 23, 2411–2420. (<http://dx.doi.org/10.1002/rcm.4025>)
- Pietsch, S.J., Hobson, K.A., Wassenaar, L.I., & Tütken, T. (2011). Tracking Cats: Problems with Placing Feline Carnivores on $\delta^{18}\text{O}$, δD Isoscapes. *Public Library of Science, ONE* Vol. 6, No. 9, e24601.
- Price, T.D., Schoeninger, M.J., & Armelagos, G.J. (1985). Bone chemistry and past behavior: an overview. *Journal of Human Evolution* Vol. 14, pp. 419–447. ([http://dx.doi.org/10.1016/S0047-2484\(85\)80022-1](http://dx.doi.org/10.1016/S0047-2484(85)80022-1))
- Rau, G.H. (1982). The relationship between trophic level and stable isotopes of carbon and nitrogen. In Coastal water research project biennial report for the years 1981–1982. Edited by W. Bascom. Southern California Water Research Project, Long Beach, Calif. pp. 143–148.
- Reynard, L.M., & Hedges, R.E.M. (2008). Stable hydrogen isotopes of bone collagen in palaeodietary and palaeoenvironmental reconstruction. *Journal of Archaeological Science*, Vol. 35, pp. 1934–1942. (<http://dx.doi.org/10.1016/j.jas.2007.12.004>)
- Rundel, P.W., Ehleringer, J.R., & Nagy, K..A eds. (1988). *Stable Isotopes in Ecological Research*. Ecological Studies. ISBN 0-387-96712-5. Springer-Verlag, New York.
- Sauer, P.E., Schimmelmann, A., Sessions, A.L., & Topalov, K. (2009). Simplified batch equilibration for D/H determination of non-exchangeable hydrogen in solid organic material. *Rapid Communications in Mass Spectrometry*, Vol. 23, No. 7, pp. 949–956. (<http://dx.doi.org/10.1002/rcm.3954>)
- Schimmelmann, A. (1991). Determination of the concentration and stable isotopic composition of nonexchangeable hydrogen in organic matter. *Analytical Chemistry*, Vol. 63, pp. 2456–2459. (<http://dx.doi.org/10.1021/ac00021a013>)
- Schimmelmann, A., & DeNiro, M.J. (1986). Stable isotopic studies on chitin III. The $^{18}\text{O}/^{16}\text{O}$ and D/H ratios in arthropod chitin. *Geochimica et Cosmochimica Acta*, Vol. 50, pp. 1485–1496. ([http://dx.doi.org/10.1016/0016-7037\(86\)90322-4](http://dx.doi.org/10.1016/0016-7037(86)90322-4))
- Schimmelmann, A., Sessions, A.L., & Mastalerz, M. (2006). Hydrogen isotopic (D/H) composition of organic matter during diagenesis and thermal maturation. *Annual Review of Earth and Planetary Sciences*, Vol. 34, pp. 501–533. (<http://dx.doi.org/10.1146/annurev.earth.34.031405.125011>)
- Schoeninger, M.J. (1985). Trophic level effects on $^{15}\text{N}/^{14}\text{N}$ and $^{13}\text{C}/^{12}\text{C}$ ratios in bone collagen and strontium levels in bone mineral. *Journal of Human Evolution*, Vol.14, pp. 515–525.
- Schoeninger, M.J. & DeNiro, M.J. (1984). Nitrogen and carbon isotopic composition of bone collagen from marine and terrestrial animals. *Geochimica et Cosmochimica Acta*, Vol. 48, pp. 625–639.
- Schwarcz, H.P. (2000). Some biochemical aspects of carbon isotopic paleodiet studies. In: *Biogeochemical Approaches to Paleodietary Analysis* (S.H. Ambrose, M.A. Katzenberg, Eds.), Kluwer Academic/Plenum Publishers New York, pp. 189–209. (http://dx.doi.org/10.1007/0-306-47194-9_10)

- Sessions, A.L., Burgoyne, T.W., Schimmelmann, A. & Hayes, J.M. (1999). Fractionation of hydrogen isotopes in lipid biosynthesis. *Organic Geochemistry*, Vol. 30, pp. 1193-1200. ([http://dx.doi.org/10.1016/S0146-6380\(99\)00094-7](http://dx.doi.org/10.1016/S0146-6380(99)00094-7))
- Smith, B. N. & Epstein, S. (1971). Two categories of $\delta^{13}C/\delta^{12}C$ ratios for higher plants. *Plant Physiology*, Vol. 47, pp. 380-384.
- Smith, C. I., Craig, O. E., Prigodich, R. V., Nielsen-Marsh, C. M., Jans, M. M. E., Vermeer, C., Collins, M. J. (2005). Diagenesis and survival of osteocalcin in archaeological bone. *Journal of Archaeological Science*, Vol. 32, pp. 105-113.
- Solomon, C.T., Cole, J.J., Doucett, R.R., Pace, M.L., Preston, N.D., Smith, L.E., & Weidel, B.C. (2009). The influence of environmental water on the hydrogen stable isotope ratio in aquatic consumers. *Oecologia*, Vol. 161, pp. 313-324. (<http://dx.doi.org/10.1007/s00442-009-1370-5>)
- Tieszen, L.L., Boutton, T.W., Tesdahl, K.G., & Slade, N.A. (1983). Fractionation and turnover of stable carbon isotopes in animal tissues: implications for $\delta^{13}C$ analysis of diet. *Oecologia*, Vol. 57, pp. 32-37.
- Topalov, K., Schimmelmann, A., Polly, P.D., Sauer, P.E., & Lowry, M. (2009). D/H of bone collagen as environmental and trophic indicator. *Goldschmidt Conference Abstracts 2009, Davos, Switzerland* (<http://goldschmidt.info/2009/abstracts/T.pdf>)
- Tuross, N. (2002). Alterations in fossil collagen. *Archaeometry*, Vol. 44, pp. 427-434.
- Tuross, N., Fogel, M.L., & Hare, P.E. (1988). Variability in the preservation of the isotopic composition of collagen from fossil bone. *Geochimica et Cosmochimica Acta*, Vol. 52, No.4, pp. 929-935. ([http://dx.doi.org/10.1016/0016-7037\(88\)90364-X](http://dx.doi.org/10.1016/0016-7037(88)90364-X))
- Tuross, N., Warinner, C., Kirsanow, K., & Kester, C. (2008). Organic oxygen and hydrogen isotopes in a porcine controlled dietary study. *Rapid Communications in Mass Spectrometry*, Vol. 22, pp. 1741-1745. (<http://dx.doi.org/10.1002/rcm.3556>)
- van der Veer, G., Voerkelius, S., Lorentz, G., Heiss, G., & Hoogewerff, J.A. (2009). Spatial interpolation of the deuterium and oxygen-18 compositions of global precipitation using temperature as ancillary variable. *Journal of Geochemical Exploration*, Vol. 101, pp. 175-184. (<http://dx.doi.org/10.1016/j.gexplo.2008.06.008>)
- van Klinken, G.J. (1991). Dating and dietary reconstruction by isotopic analysis of amino acids in fossil bone collagen - with special reference to the Caribbean. PhD thesis, University of Groningen.
- Walker, P.L. & DeNiro, M.J. (1986). Stable nitrogen and carbon isotope ratios in bone collagen as indices of prehistoric dietary dependence on marine and terrestrial resources in Southern California. *American Journal of Physical Anthropology*, Vol. 71, pp. 51-61. (<http://dx.doi.org/10.1002/ajpa.1330710107>)
- Walter, W.D. & Leslie, Jr., D.M. (2009). Stable isotope ratio analysis to differentiate temporal diets of a free-ranging herbivore. *Rapid Communications in Mass Spectrometry*, Vol. 23, pp. 2190-2194. (<http://dx.doi.org/10.1002/rcm.4135>)
- Wassenaar, L.I. & Hobson, K.A. (2000). Improved method for determining the stable-hydrogen isotopic composition (δD) of complex organic materials of environmental interest. *Environmental Science and Technology*, Vol. 34, pp. 2354-2360. (<http://dx.doi.org/10.1021/es990804i>)
- Waterlow, J.C. (2006). *Protein Turnover*. ISBN 0851996132. CABI Publishing, Wallingford, UK.
- Yakir, D. & DeNiro, M.J. (1990). Oxygen and hydrogen isotope fractionation during cellulose metabolism in *Lemna gibba* L. *Plant Physiology*, 93, pp. 325-332.

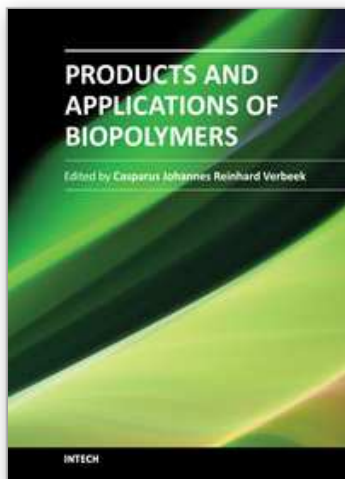

Products and Applications of Biopolymers

Edited by Dr. Johan Verbeek

ISBN 978-953-51-0226-7

Hard cover, 220 pages

Publisher InTech

Published online 07, March, 2012

Published in print edition March, 2012

It is interesting to consider that biopolymers are by no means new to this world. It is only because of our fascination with petrochemical products that these wonderful materials have been neglected for so long. Today we face a different challenge. Environmental pressure is pushing away from synthetic or petro-chemically derived products, while economic factors are pulling back from often more expensive "green" options. This book presents two aspects of biopolymers; potential products and some applications of biopolymers covering the current relevance of biopolymers.

How to reference

In order to correctly reference this scholarly work, feel free to copy and paste the following:

Katarina Topalov, Arndt Schimmelmann, P. David Polly and Peter E. Sauer (2012). Stable Isotope Applications in Bone Collagen with Emphasis on Deuterium/Hydrogen Ratios, *Products and Applications of Biopolymers*, Dr. Johan Verbeek (Ed.), ISBN: 978-953-51-0226-7, InTech, Available from:

<http://www.intechopen.com/books/products-and-applications-of-biopolymers/stable-isotope-applications-in-bone-collagen-with-emphasis-on-deuterium-hydrogen-ratios>

INTECH

open science | open minds

InTech Europe

University Campus STeP Ri
Slavka Krautzeka 83/A
51000 Rijeka, Croatia
Phone: +385 (51) 770 447
Fax: +385 (51) 686 166
www.intechopen.com

InTech China

Unit 405, Office Block, Hotel Equatorial Shanghai
No.65, Yan An Road (West), Shanghai, 200040, China
中国上海市延安西路65号上海国际贵都大饭店办公楼405单元
Phone: +86-21-62489820
Fax: +86-21-62489821

© 2012 The Author(s). Licensee IntechOpen. This is an open access article distributed under the terms of the [Creative Commons Attribution 3.0 License](#), which permits unrestricted use, distribution, and reproduction in any medium, provided the original work is properly cited.

IntechOpen

IntechOpen