

We are IntechOpen, the world's leading publisher of Open Access books Built by scientists, for scientists

4,800

Open access books available

122,000

International authors and editors

135M

Downloads

Our authors are among the

154

Countries delivered to

TOP 1%

most cited scientists

12.2%

Contributors from top 500 universities



WEB OF SCIENCE™

Selection of our books indexed in the Book Citation Index
in Web of Science™ Core Collection (BKCI)

Interested in publishing with us?
Contact book.department@intechopen.com

Numbers displayed above are based on latest data collected.

For more information visit www.intechopen.com



Feasibility of Bioenergy Production from Ultrafiltration Whey Permeate Using the UASB Reactors

Marta Kisielewska

*University of Warmia and Mazury in Olsztyn,
Poland*

1. Introduction

Cheese whey is a by-product generated during cheese manufacturing. The disposal of whey is problematic because of its high COD (Chemical Oxygen Demand) (about 50,000 mg L⁻¹ - 80,000 mg L⁻¹), low solids content (5% DM), low bicarbonate alkalinity and its tendency to get acidified very rapidly (Aktaş et al., 2006; González Siso, 1996; Venetsaneas et al., 2009). In 2008, Poland produced almost 1123 thousand tonnes of whey (Agricultural Market Agency [ARR], 2009). Traditionally, cheese whey has been used to feed animals, but redistribution of whey to farmers is very expensive. Moreover, lactose intolerance of farm animals also limits the use of whey in feeding (de Glutz, 2009). Since large quantities of whey are produced (about 9 kg of whey in the production of 1 kg cheese) (Zafar & Owais, 2006), there is an increasing concern as how it can be efficiently and cost-efficiently processed without adversely affecting the environment.

Proteins from cheese whey have a high nutritional value. For this reason cheese manufacturers have explored the possibilities of valorisation of whey. They recover proteins by membrane ultrafiltration (UF) process (Silveira et al., 2005). This method of separation has the main advantage - it does not denature proteins, so they save their original nutritional value (de Glutz, 2009). The residual protein-free material is called whey permeate. Permeate streams have very high COD value (about 50,000 - 70,000 mg L⁻¹) (own studies), which represents an important environmental problem, similarly to whey. The chemical and biological instability of the UF whey permeate resulting in difficulties and high cost in its transport and storage. Proper management of this liquid is important due to strict legislation and economic reasons. Because of those there is a strong need to efficiently treat UF whey permeate.

UF whey permeate is composed mainly of lactose. Lactose concentration is about 50,000 mg L⁻¹, so more than 90% of COD is due to lactose (de Glutz, 2009). Moreover, valuable compounds (proteins, vitamins) can be found in its composition. Since UF whey permeate contains significant quantities of lactose, the way to use this waste product could be as a substrate for fermentation to produce biofuels.

Nowadays, the most widely produced biofuels are ethanol and biogas (methane). Alcohol fuels are produced by fermentation of sugars derived from corn, sugar beet, sugarcane,

potatoes, wheat, followed by distillation and drying. The production of bioethanol from corn or sugarcane is a mature technology. For example, in Brazil there are 448 bioethanol production units installed and according to a report of the Brazilian Ministry of Mines and Energy, ethanol production was 25 billion liters in 2008 (Soccol et al., 2010). Biogas is produced by anaerobic digestion of organic materials by anaerobic microorganisms. It can be used to produce thermal energy (heating), electricity, or if compressed – it can be used in vehicles. The current operation of biogas plants is relatively large in Europe, especially in Germany. According to Pöschl et al. (2010), the estimated biogas production potential in Germany is 417 PJ per year and 80% of which derived from agricultural resources, including farm waste (96.5 PJ per year), crop residues (13.7 PJ per year), and dedicated energy crops (236 PJ per year).

More recently, hydrogen is playing more important role as a fuel used for heating, lighting and as a motor fuel. The main advantage of hydrogen as a future alternative energy carrier is the absence of polluting emissions when combusted, results in pure water. Today, most hydrogen gas is obtained from fossil fuels which generate greenhouse gas (GHG) that contribute to global warming. The biological hydrogen production is an attractive method because it can be produced from renewable raw materials such as organic wastes. Wastewater from food processing industries show great potential for economical production of hydrogen (Van Ginkel et al., 2005), but today no strategies for industrial-scale productions have been found.

The ability to produce biofuels from low-cost biomass such as agricultural waste and by-products (including for example crop residues, sugar cane waste, wood, grass and wastewater from food processing industries) will be the key to making them competitive with other fuels, for example gasoline. Only biofuels derived from waste products show low environmental effects, such as reduction of GHG emission, small land demand and damage the environment. As a result, since UF whey permeate disposal represent a real problem for the dairy industry, biofuels production offers an ideal alternative to its valorization (de Glutz, 2009; Silveira et al., 2005).

The objectives of this work were to study the applicability of fermentation processes for the production of biogas (methane), fuel bioethanol and biohydrogen in Upflow Anaerobic Sludge Blanket (UASB) reactors fed with raw UF whey permeate. To optimize and enhance the biofuels production, the different processes were used (ultrasonic stimulation of microbial cells, anaerobic steel corrosion process) and the different operational parameters (pH, hydraulic retention times - HRTs regimes, organic loading rates - OLRs) were applied.

2. Biogas production

Biogas is a gas with 50-70% of methane (CH_4) and 30-50% of carbon dioxide (CO_2) content produced by the anaerobic decomposition of organic matter. It can be produced from a wide variety of available waste organic materials, including sewage sludge, animal manure, municipal/industrial organic waste, parts from ethanol production, crop residues, specially grown energy crops and more. Methane, the combustible component of biogas, mainly determines the properties of biogas. A m^3 of biogas produced from food industrial organic wastes has on average a methane content of about 55% and therefore a calorific value of about 6.5 kWh (Angelidaki et al., 2003). Nowadays, the world markets for biogas are

booming. Advances in biotechnology, molecular science and microbiology contributed to enhancements in biogas yields production (more high tech resulting in over 70% plant efficiency), which led to the development of commercial biogas plants (Yadvika et al., 2004). As a result, biogas competes with petroleum-based fuels in terms of performance, cost, and additional benefits such as reducing GHG emissions. Currently Europe dominates in biogas production (Prochnow et al., 2009). Germany, the biogas market leader, runs about 5000 biogas plants in 2009, covering more than 1% of the electrical energy consumption from biogas (Meyer-Aurich et al., 2012). However, the trend in producing biogas is also catching up fast in countries like Japan, Australia, New Zealand, USA, China and India.

Innovations are still necessary to support research and development in the field of renewable energy. The main research area is closely related to renewable biomass feedstock. Consequently, the objectives of this work were: (1) to investigate anaerobic biogas potential from UF whey permeate, (2) to evaluate if steel elements could enhance the performance of UASB reactors treating UF whey permeate (COD removal efficiency, phosphorus removal), and (3) to study the influence of steel elements on the biogas production rate and methane content in biogas.

2.1 Materials and methods

2.1.1 Fermentation medium and experimental system

Two identical Plexiglas laboratory-scale UASB reactors (R_0 and R_{Fe}) with a working volume of 2.05 L each, one packed with spiral elements made of steel wire with an iron content of 48% (Fig.1; Table 1), were run in parallel at a constant mesophilic temperature of $35^\circ\text{C} \pm 1^\circ\text{C}$ throughout a 219-day period. Four running stages were identified in term of OLR applied (Table 1). The OLR was increased stepwise from the initial $2.0 \text{ kg COD m}^{-3} \text{ d}^{-1}$ to finally $12.0 \text{ kg m}^{-3} \text{ d}^{-1}$. The reactors were operated for 25 – 66 days to ensure the reactors reached steady states at each stages (the steady-state conditions were evidenced when the standard deviations of COD removal efficiencies were within 3%). After the steady-state conditions were achieved, the OLR was increased to the next level. HRT at all stages was 48 h. The pH in the reactors was controlled at the level of 7.0 ± 0.05 with 2 M NaOH.

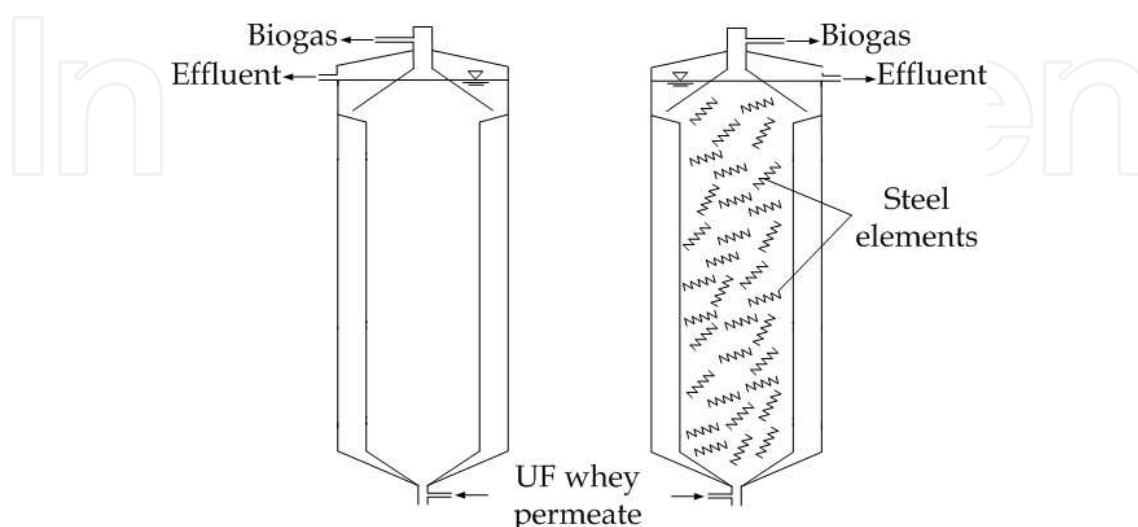

Fig. 1. Schematic of the laboratory-scale anaerobic treatment system

	Stage 1	Stage 2	Stage 3	Stage 4
Operation period (d)	45 - 69	70 - 105	106 - 153	154 - 219
OLR (kg COD m ⁻³ d ⁻¹)	2.0	4.0	7.0	12.0
HRT (h)	24	24	24	24
Contact surface of the packing medium (m ²)	0.00175	0.00175	0.00175	0.00175
Packing volume of steel elements (L)	0.0087	0.0087	0.0087	0.0087

Table 1. Operation regimes for the parallel UASB reactors with and without steel elements

Both UASB reactors were fed with UF whey permeate from the manufacture of dairy products in Nowy Dwór Gdański, Poland. The characteristics of the wastewater used in this study is shown in Table 2. It was received from the factory once a week, was stored at -20°C and was thawed before used. Prior to being fed into the reactor, the substrate was diluted with tap water in accordance with the required organic loading rate (OLR) to obtain wastewater COD concentrations in the average range of 4 - 24 g COD L⁻¹. Diluting UF whey permeate was maintained at a temperature 4°C until used. The reactors were not supplemented with trace elements.

Parameters	Range of values
Total COD (g L ⁻¹)	52 - 55
Lactose (g L ⁻¹)	48 - 53
TP (g L ⁻¹)	0.58 - 0.62
Phosphate (g L ⁻¹)	0.49 - 0.54
pH (when fresh at 20°C)	4.9 - 5.4
Total iron (mg L ⁻¹)	0.26 - 0.35

Table 2. Chemical characteristics of wastewater used

The seeding inoculum was taken from a laboratory mesophilic reactor treating synthetic dairy wastewater. Each UASB reactor was seeded up to biomass content of 70 g total suspended solids - TSS L⁻¹ at a ratio of 20% (by volume). During startup the reactors were operated at an OLR of 1.0 kg COD m⁻³ d⁻¹ and at a HRT of 48 h for 44 days. During the reactors operation, biogas production and composition (CH₄ and CO₂), total COD, total phosphorus - TP, phosphate, soluble iron concentration and pH in the effluent were measured three times a week. After the operation time of 219 days, sludge samples from both UASB reactors were collected for the determination of TSS content, TP and total iron contents.

2.1.2 Analytical methods

All monitored parameters were analyzed according to the Standard Methods for the Examination of Water and Wastewater (PN-74/C-04578.03; PN-90/C-04586.04; PN-EN 1189:2000; PN-75/C-04616.01; PN-67/A-86430; PN-EN ISO 6878:2006; PN-EN 13346:2002). The measurement of the pH was done using an Hanna Instruments pehameter model HI 9107. Biogas production from the UASB reactors was recorded by a water displacement meter, while biogas composition was analyzed by an electronic analyzer (LMSxi/G4.18, Gas Data Ltd.). All selected reactors performance parameters were analyzed with Fisher F-tests using Statistica 7.1 software (Statsoft Inc.). Differences were considered statistically significant if the 95% confidence interval of the mean of the parameters did not overlap.

2.2 Results and discussion

The COD removal efficiency, TP removal efficiency, biogas production and composition were markedly influenced by using steel elements as an additional medium in the UASB reaction chamber.

During Stage 1, both UASB reactors reached the steady-state after 25 days of operation. No statistically significant differences ($p > 0.05$) were observed between UASB reactor with steel elements (R_{Fe}) and UASB reactor without steel elements (R_0) in term of the average COD removal efficiency and biogas production rate (Fig. 2; 3). Nevertheless, R_{Fe} indicated higher ($p < 0.05$) removal efficiency in phosphate (86.2%) and TP (81.2%) than R_0 in which the analyzed values were 1.8% and 22.8%, respectively (Fig. 3). CH_4 content in biogas produced in R_{Fe} was as high as 67.1% which was higher by 11.9% than in R_0 ($p < 0.05$). In Stage 2 and 3 both UASB reactors demonstrated a stable work, but statistically significant differences in the values of all the monitoring parameters between R_0 and R_{Fe} were noticed ($p < 0.05$). The duration of each stage were 36 and 48 days, respectively. The average TP removal efficiency and phosphate removal efficiency in R_{Fe} were higher by 77.7% and 83.7%, respectively than in R_0 during Stage 2, and 68.1% and 73.9%, respectively during Stage 3 (Fig. 3). During Stage 2 and 3 high COD removal efficiencies (95.6%, 94.8%, respectively) were remained in R_{Fe} , in contrast to that of 84.2% in Stage 2 and 80.1% in Stage 3 in R_0 (Fig. 3). The average CH_4 content in biogas of 78.0% and biogas production of $2.59 \text{ m}^3 \text{ m}^{-3} \text{ d}^{-1}$ in R_{Fe} , in contrast to that of 60.8% and $0.92 \text{ m}^3 \text{ m}^{-3} \text{ d}^{-1}$, respectively in R_0 ($p < 0.05$), were observed during Stage 2. In Stage 3, biogas production increased by $1.12 \text{ m}^3 \text{ m}^{-3} \text{ d}^{-1}$ in R_0 and $1.2 \text{ m}^3 \text{ m}^{-3} \text{ d}^{-1}$ in R_{Fe} , but it was still significantly higher in R_{Fe} ($3.79 \text{ m}^3 \text{ m}^{-3} \text{ d}^{-1}$) than in R_0 ($2.04 \text{ m}^3 \text{ m}^{-3} \text{ d}^{-1}$), $p < 0.05$ (Fig. 2). Moreover in that stage, the highest methane content in biogas of 79.8% in R_{Fe} and 68.1% in R_0 were achieved (Fig. 2). During the last stage it was found the highest biogas production rate in R_{Fe} of $4.01 \text{ m}^3 \text{ m}^{-3} \text{ d}^{-1}$, while $1.86 \text{ m}^3 \text{ m}^{-3} \text{ d}^{-1}$ in R_0 was observed ($p < 0.05$). The average

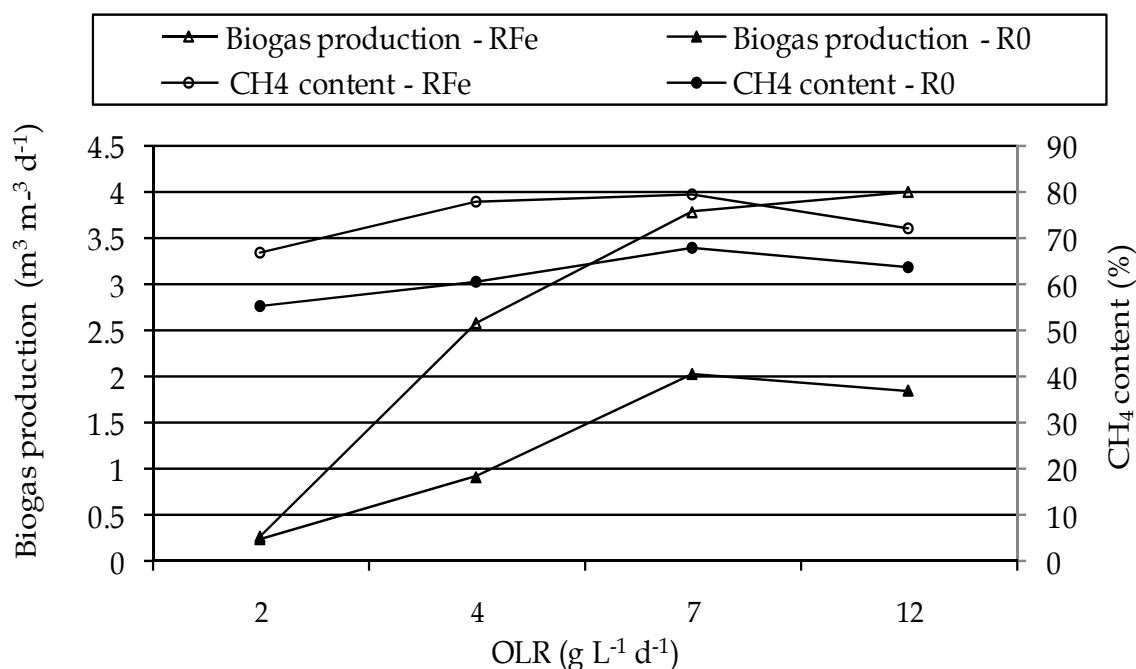

Fig. 2. Biogas production rate and CH_4 content in biogas

CH₄ content in biogas decreased to 72.3% in R_{Fe}, in contrast to that of 64% in R₀, and the differences between R₀ and R_{Fe} were statistically significant ($p < 0.05$) (Fig. 2). It was found decrease in TP removal efficiency in R_{Fe} and R₀ to 72.2 and 10.1% ($p < 0.05$), respectively. According to this, the phosphate removal efficiencies decreased, too (Fig. 3). COD removal efficiency was lower than in Stage 3 and achieved 88.8% in R_{Fe} and 71.8% in R₀, $p < 0.05$ (Fig. 3).

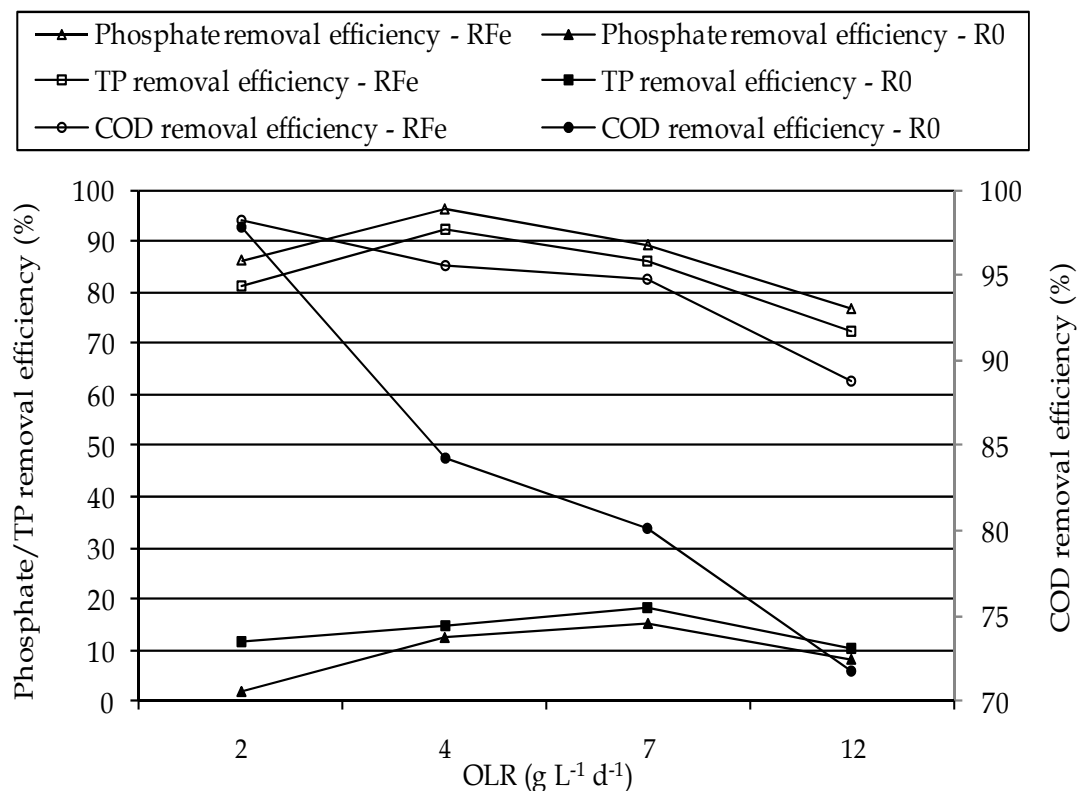

Fig. 3. COD, TP and phosphate removal efficiencies

The study demonstrated that the COD removal efficiency was markedly influenced by using steel elements as an additional medium of the UASB reactor. Iron ions generated from the steel elements must have acted as coagulants and were involved in the removal of suspended organic matter. After the operation time of 219 days, sludge samples from both UASB reactors were collected for the determination of TSS, which was higher by 52.1% in R_{Fe} than in R₀. Moreover, ferrous ions in wastewater could react to form hydroxides which were the sorption areas for suspended organic matter. Additional sorption areas were made by steel elements surface. Enhancement of COD removal efficiency by zero-valent iron processes were reported by Jeon et al. (2003) and Lai et al. (2007). Vlyssides et al. (2009) showed that the addition of ferrous ions in the form of ferrous chloride solution (2% w/v) induced a stable and excellent COD removal efficiency from synthetic milk wastewater, regardless of the increasing in OLR. When the OLR was as high as 10 g COD L⁻¹ d⁻¹, the COD removal efficiency of 98% was achieved.

Anaerobic steel media corrosion significantly improved TP and phosphate removal from UF whey permeate, but the removal efficiency was affected by the duration of experiment because of deterioration of steel media. The concentration of TP decreased as the phosphate

reacted with ferrous iron to probably form insoluble vivianite precipitated in the reaction chamber. It can be confirmed by significant increasing of TSS (by 52.1% in R_{Fe}) and the accumulative iron ions and phosphorus content detected in the anaerobic granular sludge in R_{Fe} at the end of the experimental period. The TP and total iron percentage in the dry matter was 0.314 and 0.0981, respectively, in R_{Fe} and 0.019 and 0.0129, respectively, in R_0 . This results confirmed the anaerobic microbial corrosion occurred in R_{Fe} . Choung & Jeon (2000) and Jeon et al. (2003) obtained similar trends for domestic wastewater treatment under anaerobic conditions. Moreover, the colour of anaerobic sludge granules from R_{Fe} was black, while from R_0 was grey with white conglomerates (Fig. 4). It indicates that the presence of iron determine the colour of granules. The black colour of granules is due to the formation of large amounts of iron sulphide precipitate (Vlyssides et al., 2009). It was seen that the granule diameter in the sludge bed in R_{Fe} was smaller than in R_0 . It was different from the data reported by Vlyssides et al. (2009), who observed a considerable increase of 40% in the mean granule diameter resulted in iron accumulation in granules.

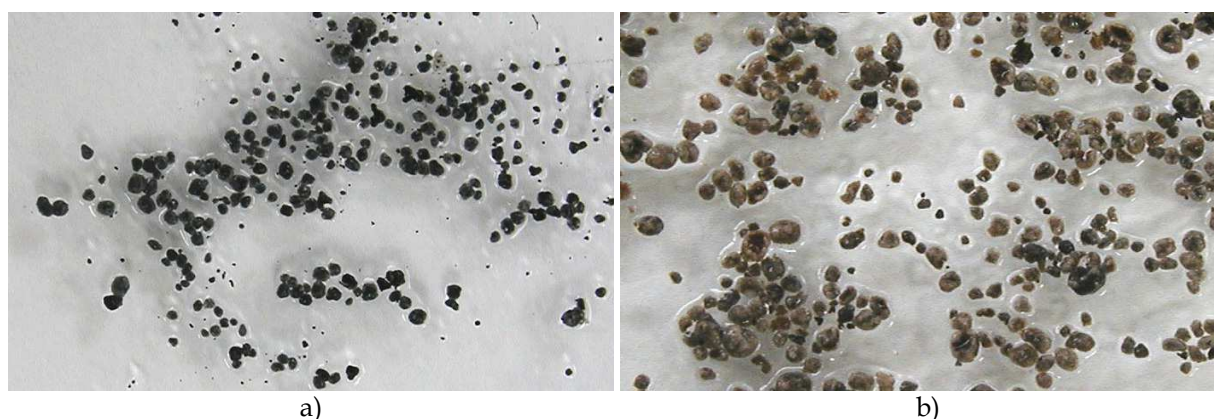

Fig. 4. The photography of granular sludge in UASB reactor a) without steel elements, b) packed with steel elements

During the experimental period high iron concentrations in the R_{Fe} effluent were observed. During Stage 1, the highest content of iron was noticed (20.1 mg L^{-1}) and it was consequently decreased to 19.2, 15.8, 14.2 mg L^{-1} in Stage 2, 3, 4, respectively. The decrease of the total iron in the effluent from the UASB reactor packed with steel elements can indicate the formation of a protective layer on the steel surface. According to Volkland et al. (2001) under certain conditions the vivianite could act as a corrosion-inhibiting layer. Moreover, biofilm-forming bacteria can protect steel from corrosion. With a dense suspension of microorganisms ($> 10^9 \text{ cells mL}^{-1}$) they can protect the steel surface by forming a corrosion-inhibiting layer in consequence of bacterial adsorption and adhesion (Volkland et al., 2001; Yu et al., 2000). Microbial corrosion and the formation of iron precipitates deteriorate the reactive media of steel elements (Karri et al., 2005). It could explain the gradual decrease in phosphorus and TP removal with the duration of the experiment.

Biogas production rate and CH_4 content in biogas were higher in R_{Fe} than in R_0 in all stages (except Stage 1 where the differences in biogas production between R_{Fe} and R_0 were not statistically significant). According to Karri et al. (2005) zero valent iron was an electron donor for methanogenesis. It suggested that microbial corrosion of steel elements supported methanogenesis which contributed to the more CH_4 and biogas production in R_{Fe} . Iron may

play an important role in granulation phenomena and was found to be a component of essential enzymes that carry out numerous anaerobic reactions (Vlyssides et al., 2009; Yu et al., 2000). The conversion of COD to biogas components and bacterial growth may be limited at iron deficient concentrations. However, the accumulation of iron ions may decrease the specific activity of the bacterial groups, including methanogens (Yu et al., 2000). It was reported that high Fe^{2+} concentration in the anaerobic sludge granules led to decrease of the specific activity of biomass due to the presence of a large amount of minerals deposited within the granules, a significant decrease in the water content in granules, and the possible toxicity of high-concentration Fe^{2+} accumulated inside the granules (Yu et al., 2000). During the experiment, biogas production rate was not decreased from Stage 1 to 4, which could indicate that the activity of methanogenic bacteria was not inhibited by anaerobic steel corrosion process. The maximum value for biogas rate was 8.22 L d^{-1} in R_{Fe} and 4.2 L d^{-1} in R_0 . Najafpour et al. (2008) achieved the biogas production of 3.6 L d^{-1} for HRT of 48 h with the methane content of 76% from UF whey permeate. Venetsaneas et al. (2009) achieved about $1 \text{ L CH}_4 \text{ d}^{-1}$ and 68% v/v methane content in biogas in the two-stage process for cheese whey fermentation.

2.3 Conclusions

On the basis of this study, it is expected that the UASB reactors packed with steel elements may be applicable to treat UF whey permeate to produce biogas with high CH_4 content. The COD removal efficiency, biogas productivity and CH_4 content in biogas were enhanced by 11.4 - 17.0% ($p < 0.05$), $1.67 - 2.15 \text{ m}^3 \text{ m}^3 \text{ d}^{-1}$ ($p < 0.05$), 8.3 - 17.2% ($p < 0.05$), respectively, in the UASB reactor packed with steel elements compared to the control reactor performances. In this work, the maximum biogas production rate was 8.22 L d^{-1} in the reactor containing additional iron medium in contrast to about 4.2 L d^{-1} in the control reactor. Total phosphorus removal efficiency obtained in R_{Fe} was higher by 58.4 - 77.7% than in R_0 ($p < 0.05$). High iron concentration in the anaerobic granular sludge was not contributed to inhibit the activity of methanogenic bacteria. It should be pointed that during anaerobic corrosion process a protective layer on the steel surface can be formed to decrease phosphorus removal efficiency.

3. Bioethanol production

Bioethanol is an alcohol made by fermenting the rich sugar components of biomass which is seen as a good fuel alternative. The use of bioethanol as a biofuel has very important advantage - it is generally CO_2 neutral. This is achieved because in the growing phase of the biomass plants, CO_2 is absorbed and then released in the same volume during combustion of the fuel (Stephenson et al., 2010). This creates an obvious advantage over fossil fuels which only emit CO_2 as well as other poisonous gasses. Bioethanol can be used as a fuel for transport in its pure form, but it is usually used as a gasoline additive to increase its octane rating and improve vehicle efficiency (Balat & Balat, 2009).

Nowadays, the bioethanol market has continued to grow rapidly, for example, from about 46 billion L of ethanol produced worldwide in 2007 to the expected value of 100 billion L in 2015 (Balat & Balat, 2009; Sarkar et al., 2012). The USA is the world leader in the production of bioethanol with 48 billion L in 2009 (Muthaiyan & Ricke, 2010), followed by Brazil with 27,0 billion L in 2009 (Soccol et al., 2010) which determined 62% of the worldwide

production (Sarkar et al., 2012). In the USA, bioethanol is mainly used as a 10% petrol additive (E10 is the standard petrol fuel, in 2011 introduced E15). In Brazil, it is offered both as a pure fuel (E100) and is blended with conventional petrol with a content of 20 to 25% (E20, E25). In Europe, with the adoption of the Biofuel Directive 2003/30/EC in 2003, the framework conditions were especially created for European bioethanol production. Today France is a leading producer of bioethanol, then Germany, Spain, Sweden and Dutch are the significant producers in Europe (Gnansounou, 2010). Current large scale production of fuel ethanol is mainly based on sugarcane (Brasil), corn (the USA), sugar beet and wheat (Europe), (Balat & Balat, 2009). The recent rise in the prices of food ethanol biomass has shifted in focus towards a possibility of deriving fuel ethanol from any type of biomass, especially cellulosic biomass (corn or wheat straw, sugarcane bagasse, wood, grass) and food waste biomass (organic waste and wastewater from food processing industries) (Sarkar et al., 2012; Soccol et al., 2010).

According to the literature, cheese whey could be a suitable substrate for bioethanol production (Kourkoutas et al., 2002; Zafar & Owais, 2006). Lewandowska & Kujawski (2007) used a solution of dried UF whey permeate as a substrate for semi-continuous ethanol fermentation. Silveira et al. (2005) fermented the solution of UF whey permeate in batch cultures. Ghaly & El-Taweel (1997) developed a kinetic model for continuous ethanol fermentation from lactose. Moreover, in 2008 there were two industrial scale whey-ethanol plants in the United States which produced 8 million gallons of fuel ethanol per year (Ling, 2008). In New Zealand there were whey-ethanol plants with an annual production of about 5 million gallons of ethanol (Ling, 2008). Industrial-scale plants producing bioethanol from whey permeate are operated in Ireland (de Glutz, 2009).

There are many reports of potential applications of yeast strains in ethanol production from UF whey permeate streams, but most of them focused on *Kluyveromyces sp.* due to its ability to directly ferment lactose (Kourkoutas et al., 2005; Ozmişci & Kargi, 2008; Silveira et al., 2005;). These yeasts generally suffer from low conversion yields (0.4 kg ethanol kg⁻¹ lactose) and are very sensitive to product (ethanol) inhibition at concentrations as low as 20 g L⁻¹ (de Glutz, 2009). An alternative is to employ indirect fermentation yeasts, such as *Saccharomyces cerevisiae*, which show considerably better ethanol fermentation performance (0.520 kg ethanol kg⁻¹ lactose) and much higher alcohol tolerance (100 - 120 g L⁻¹) (Coté et al., 2004; de Glutz, 2009). The disadvantage of using *S. cerevisiae* is the inability to directly ferment lactose. It can be solved by genetic manipulation of yeasts or facilitate the process with a simultaneous lactose hydrolysis, for example by co-immobilization of yeast cells with the enzyme (Coté et al., 2004; Guimarães et al., 2008). Moreover, higher ethanol production could be achieved by application of different stimulation processes, improving biological activity of yeasts. Many researchers have found that ultrasonic stimulation has the function of promoting the activity of enzyme, cell growth and cell membrane permeability (Chisti, 2003; Liu et al., 2003a; Liu et al., 2007; Schläfer et al., 2000). However, application of ultrasonic irradiation at improper intensity or period has destructive impact on cells by disrupting the cell membranes and deactivating biological molecules such as enzymes or DNA (Liu et al., 2007).

The objectives of the studies were: (1) to investigate bioethanol production from UF whey permeate in continuous fermentation in UASB reactors by *K. marxianus* 499, (2) to evaluate the effects of low intensity ultrasound (20 kHz, 1 W L⁻¹) for ethanol production from UF whey permeate by *S. cerevisiae* B4.

3.1 Bioethanol production by *Kluyveromyces marxianus*

3.1.1 Materials and methods

3.1.1.1 Microorganisms

Kluyveromyces marxianus 499 obtained from Institute of Agricultural and Food Biotechnology Warsaw, Poland, in lyophilized form was used in all experiments. The yeast strain was cultivated on plates prepared with Wort Agar growth media from Merck Company Darmstadt (Germany) with the addition of 3% lactose using an incubator shaker under sterile conditions at pH 4.5 and a temperature 25°C for 48 h. The yeast was aseptically transferred from the plates into 300 ml cultivation flasks containing 100 ml of Wort Agar medium from Merck Company Darmstadt (Germany) supplemented with 3% lactose, and cultivated at 25°C for 24 h on a rotatory shaker. The yeast culture was immobilized and suspended in 2% w/v sodium alginate and then added drop-wise to 1.5% w/v CaCl₂ solution. The CaCl₂ was decanted. The beads were used for inoculation of experimental reactors.

3.1.1.2 Fermentation medium and experimental system

A solution of dried permeate from UF whey permeate from the Dairy Plant in Wolsztyn, Poland, was used as a substrate in this study. The solution was prepared by dissolving dried permeate in distilled warm water to obtain 50 g L⁻¹ lactose concentration in wastewater, while the initial COD was 56 g L⁻¹.

Fermentation process was carried out in three UASB reactors with an active volume of 5 L. There were the gas-liquid-solid (G-L-S) separators on the top of each reactor. Whey permeate solution was pumped continuously to the bottom part of the reaction tank by means of the peristaltic pump. The necessary mixing was achieved through the upward wastewater flow and a stirrer operated at 40 rpm. The reactors were water-jacketed and operated at a constant temperature of 25°C ± 1°C. The pH of mixed liquid in the reactors was controlled automatically at pH 4.76 – 4.86 with 2 M NaOH.

For start-up of continuous culture, 1 L of the beads culture medium were grown at 25°C for 24 h in a 2 L Erlenmeyer flask filled with 0.5 L of UF whey permeate after heat sterilization (120°C, 20 min). The concentration of lactose in whey permeate was 50 g L⁻¹. Mixing was achieved by stirring with a magnetic stirrer at 200 rpm. The cell suspension was then aseptically transferred to each UASB reactor which was kept in batch operation for 24 h before switching on the continuous feeding. The reactors were operated at the HRTs of 12, 24 and 48 h. At each HRT the reactors were operated till they had reached the steady-state (the steady-state conditions were evidenced when the standard deviations of the ethanol concentrations and lactose concentrations in the effluent distillate were within 3%).

3.1.1.3 Analytical methods

Lactose concentrations and ethanol concentrations in the effluent distillate were determined according to Standard Methods (PN-67/A-86430; PN-A-79528-3:2007). The biomass concentration of yeast (dry matter) was calculated according to Standard Methods (P-78/C-04541). The samples were analyzed in triplicate and results were reproducible within 3% standard deviation.

3.1.2 Results and discussion

The effects of HRTs on the lactose concentration in the effluent distillate and percent lactose consumption are shown in Fig. 5. When the HRT was 12 h, the average lactose concentration in the effluent distillate was as high as 25 g L⁻¹ and the average lactose utilization efficiency was only 50%. Increasing the HRT from 12 to 24 h increased the average yield of lactose utilization to 85%. Further increase in the HRT from 24 to 48 h resulted in the highest lactose utilization of 95%. Similar results obtained Ghaly & El-Taweel (1997). They observed 98% lactose utilization for continuous fermentation from cheese whey with 50 g L⁻¹ initial lactose concentration at the HRT of 42 h using the yeast strain of *Candida pseudotropicalis*. Kargi & Ozmihci (2006) reported complete fermentation of lactose (35 g L⁻¹ initial lactose concentration) in cheese whey powder (CWP) solution using the yeast strain of *K. marxianus* at HRT of 48 h. Zafar & Owais (2006) obtained about 86% lactose utilization from crude whey within 22 h by *K. marxianus*.

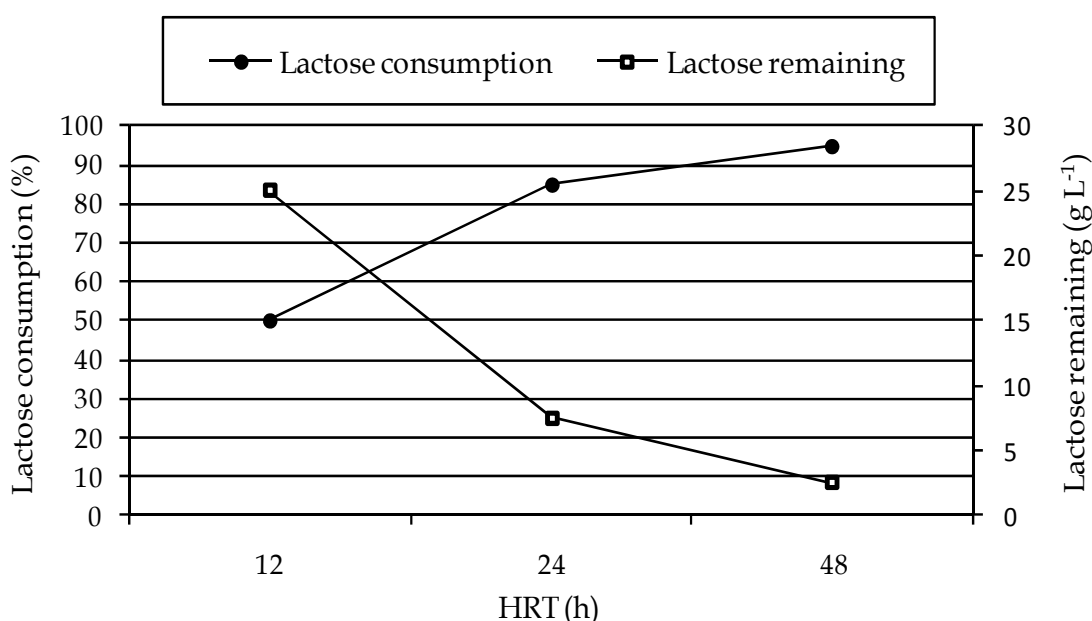

Fig. 5. Effects of HRT on the lactose concentration in the effluent and percent lactose consumption

According to Ghaly & El-Taweel (1997) lower lactose fermentation efficiency under low HRT could be attributed to the cell washout phenomenon and the low cell numbers in the reactor chamber. To remove this problem, during this experiment, the reactors were provided with G-L-S separator and the immobilization of yeast culture was done. The immobilization process made ethanol production more efficient compared to the free system and prolonged the activity of yeast cells (Kourkoutas et al. 2004), which is especially important in continuous fermentation processes. Moreover, the application of immobilization process reduced the risk of microbial cells infection when the yeasts were cultivated on the fermentation medium that was not sterilized before use (Lewandowska & Kujawski, 2007).

Fig. 6 shows the variations of daily ethanol production and ethanol concentration with the initial lactose concentration of 50 g L^{-1} . The maximum daily ethanol production of $8.61 \text{ g L}^{-1} \text{ d}^{-1}$ was obtained at the HRT of 24 h. Increasing in the HRT to 48 h decreased daily ethanol production to the average value of $7.73 \text{ g L}^{-1} \text{ d}^{-1}$ in spite of the fact that alcohol concentration increased from 8.61 to 15.45 g L^{-1} . When the HRT was 12 h, the average daily ethanol production was $4.46 \text{ g L}^{-1} \text{ d}^{-1}$, while the average ethanol concentration was as low as 2.24 g L^{-1} . The results were similar to the ones obtained by Kourkoutas et al. (2002). The ethanol productivity was 7.0 and $8.0 \text{ g L}^{-1} \text{ d}^{-1}$ at the HRT of 25 and 20 h respectively, using whey as a substrate fermentation and immobilized cells of *K. marxianus*.

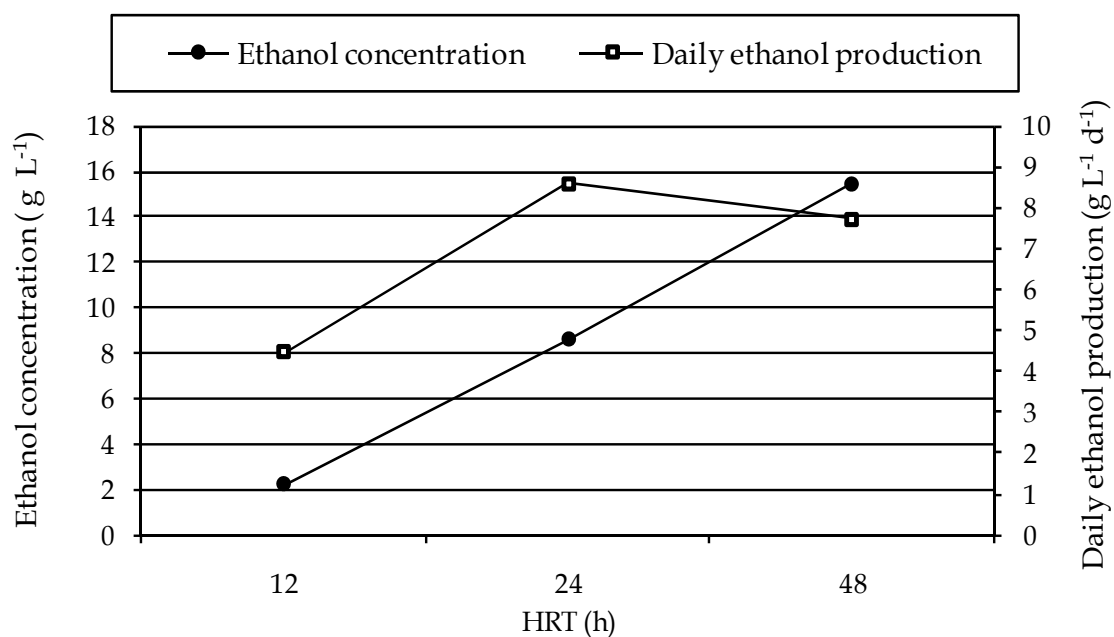

Fig. 6. Effects of HRT on daily ethanol production and ethanol concentration in the effluent.

The negative effect of longer HRT on the daily ethanol productivity could be associated with a negative effect of increasing concentration of ethanol. According to Golubev & Golubev (2004) ethanol concentration of 2 - 4% produces a negative effect on the growth of *Kluyveromyces*. Silveira et al. (2005) observed the growth inhibition of *K. marxianus* when the ethanol concentration increased from 10 g L^{-1} to 20 g L^{-1} . de Gultz (2009) studied alcohol tolerance of direct whey fermenting yeasts (four strains of *K. marxianus*) and indirect whey fermenting yeasts (three strains of *S. cerevisiae*). From the results it can be seen that some strains of *K. marxianus* showed considerable alcohol tolerance of $71 - 81 \text{ g L}^{-1}$ with fermentation times ranging from 11 to 32 h, while alcohol tolerance for *S. cerevisiae* reached $85 - 148 \text{ g L}^{-1}$ with fermentation time ranging from 29 to 64 h.

Increasing in the HRT, increased the ethanol yield (g ethanol g^{-1} consumed lactose), (Fig. 7). The ethanol yield obtained in this study was 0.089 , 0.203 , 0.325 g g^{-1} at the HRT of 12, 24, 48 h, respectively. Silveira et al. (2005) obtained a higher ethanol yield of 0.52 g g^{-1} with the initial lactose concentration of 50 g L^{-1} with the yeast strain of *K. marxianus*.

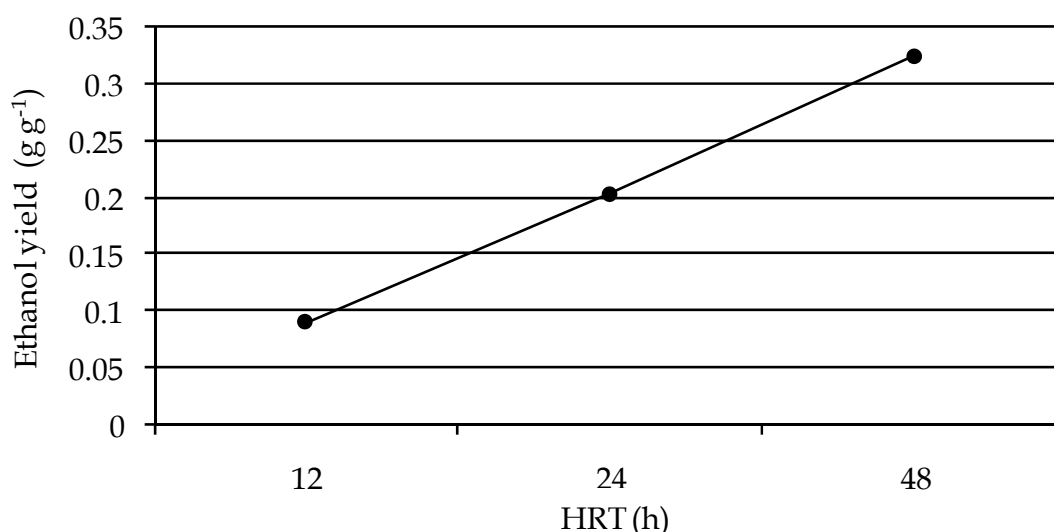

Fig. 7. Effect of HRT on the ethanol yield.

Ozmihci & Kargi (2007) stated, that biomass concentration is an important parameter affecting the ethanol formation efficiency. The volumetric rate of sugar utilization can increase with biomass concentration. They found that when the biomass concentration was 510 mg L⁻¹, the rate of sugar utilization was about 1580 mg L⁻¹ h⁻¹ at HRT of 30 h. The maximum sugar utilization rate of 2200 mg L⁻¹ h⁻¹ they obtained at the biomass concentration of 1020 mg L⁻¹ and HRT of 24 h. In this study the concentration of yeast in the UASB reactors ranged from 705 to 869 mg L⁻¹ by the duration of the experiment. The volumetric rate of sugar utilization was as high as 927, 1576, 1724 mg L⁻¹ h⁻¹ at HRT of 12, 24 and 48 h, respectively.

3.1.3 Conclusions

The utilization of whey UF permeate to ethanol in continuous fermentation is possible. *Kluyveromyces marxianus* was able to metabolize lactose and the total fermentation efficiency was as high as 95%. The lactose utilization and ethanol production were connected with the HRT. The maximum daily ethanol production of 8.61 g L⁻¹d⁻¹ was achieved when the HRT was 24 h and the ethanol yield was 0.203 g g⁻¹. The results indicated that the HRT should be 24 h to obtain high rates of ethanol formation and to avoid product inhibition. Doubling the HRT to 48 h did not contribute to a noticeable increase of ethanol production and the daily ethanol production decreased to 7.73 g L⁻¹d⁻¹ while the ethanol yield was 0.325 g g⁻¹.

3.2 Bioethanol production by *Saccharomyces cerevisiae*

3.2.1 Materials and methods

3.2.1.1 Microorganisms

The yeast *Saccharomyces cerevisiae* B-4 obtained from Institute of Agricultural and Food Biotechnology Warsaw, Poland, was used for assessment ultrasound exposition to ethanol production. The yeast cultures were cultivated on YPG slants (2% glucose, 2% peptone, 1% yeast extract) supplemented with 2% agar, at pH 5.0 and 30 °C for 24 h. The active cultures

for inoculation were prepared by growing the yeast in a 1 L baffled shake-flask containing sterile water and 100 mL YPG medium at 30 °C for 24 h on orbital shaker table at 200 rpm to a concentration of approximately 10^8 cells mL⁻¹. The cultures in baffled shaken flasks of 100 mL were used to prepare the inocula. After 24 h of incubation at 30 °C, the precultures were centrifuged at 3800 rpm for 10 min and the cells were resuspended in sterile water to obtain 10^6 cells mL⁻¹. Enzyme β -D-galactosidase (optimum temperature 30 °C, optimum acidity pH 4.5-5.0, activity 8.7 AU mg⁻¹ d.m. of the preparation), from *Aspergillus oryzae* manufactured by the SIGMA company (USA), was used for co-immobilization process. The amount of yeast and enzyme was 3% free cell inoculum and 4 cm³ enzyme solution. The yeast culture was co-immobilized in the 2% (w/v) sodium alginate by dropping yeast and enzyme into 150 cm³ 0.09 mol L⁻¹ solution of CaCl₂ with 10% glucose. The cell beads were washed with sterile water and were stored as a fermentation medium in physiological solution at 8 °C.

3.2.1.2 Fermentation medium and experimental system

UF whey permeate (non-deproteinized, non diluted and non-sterilized) with the average lactose concentration of 50 g L⁻¹ from the Dairy Plant in Nowy Dwór Gdański, Poland, was used as a fermentation substrate (Table 2).

Continuous fermentation was carried out in the laboratory-scale plant consisted of the two UASB reactors with a working volume of 5 L each (Fig. 8). These two reactors were used to enable parallel test series with and without ultrasound irradiation. The fermentation medium was pumped continuously to the bottom part of the reaction tank by means of the peristaltic pumps. The necessary mixing was achieved through the upward wastewater flow. The reactors were water-jacketed and operated at a constant temperature of 30 ± 1 °C. The pH of mixed liquid in the reactors was controlled automatically at $\text{pH } 5.1 \pm 0.2$ with 2 M NaOH.

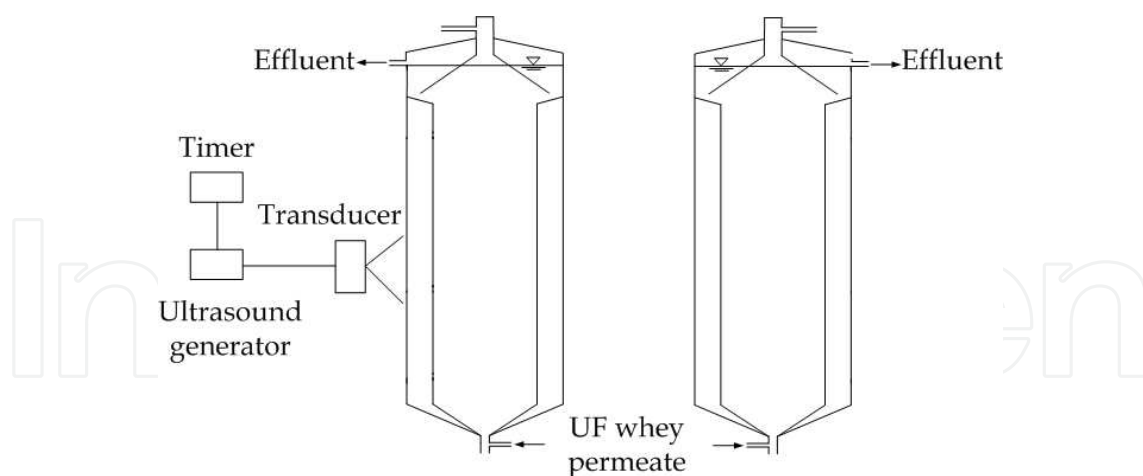

Fig. 8. A scheme of the research station.

The reactors were inoculated with 40% (v/v) solid beads containing the immobilized cells which corresponded to 39.4 g cells dry weight - DW L⁻¹ of working bioreactor volume. After adding the cell beads inoculum to the bioreactors, before starting continuous feeding, a batch fermentation was conducted for 24 h under additional gentle agitation (100 rpm). Next the reactors worked at different HRTs of 12, 24 and 36 h. At each HRT the reactor was operated till it has reached the steady-state (the steady-state conditions were evidenced

when the standard deviations of the ethanol and lactose concentrations in the effluent distillate were within 3%), thus 30 days of each fermentation step (step 1 – HRT of 12 h, step 2 – HRT of 24 h, step 3 – HRT of 36 h). The fresh inoculum was added to the reactors before each fermentation step and the aged one was removed.

The ultrasound irradiation of the reactor with yeasts was made by a special ring with a transducer (Intersonic S.C. Poland) that was attached at the bottom of the reactor. The range of the frequency generator was adjustable between 20–25 kHz and the maximum power of 50 W. The experiments were carried out with the stable sonication power of 1 W L⁻¹ and the frequency of 20 kHz.

3.2.1.3 Analytical methods

Lactose and ethanol concentrations in the effluent distillate were determined according to Standard Methods (PN-67/A-86430; PN-A-79528-3:2007). The samples were analyzed in triplicates and results were reproducible within 3% deviation.

All fermentation steps connected with different HRTs were carried out in triplicate. Significant differences between the effects obtained in the two reactors with and without ultrasound exposure were analysed using an ANOVA *F*-test (Statistica 7.1 software, Statsoft Inc.) A 5% probability level was applied for all the tests. If $p < 0.05$ from an ANOVA *F*-test, the differences between the effects were considered to be significantly different from one another.

3.2.2 Results and discussion

3.2.2.1 Sonification parameters

In the experiment, the frequency of applied ultrasounds was 20 kHz and the power input was 1.0 W L⁻¹. The initial experiments were done to find the best irradiation period. The experiments revealed, that continuous low energy ultrasound irradiation during 12, 24 and 36 h did not enhance ethanol productivity by co-immobilized *S. cerevisiae*, moreover the ethanol yield coefficients were lower than those obtained in experiments without ultrasound irradiation. The subsequent experiments were carried out with time intervals with and without ultrasonic irradiation in order to obtain the positive influence of ultrasound on biological activity of *S. cerevisiae*. The results showed that the culture should have been sonicated for 1 min every 6 h. It was similarly to results obtained by Marques et al. (2006). They investigated the effect of ultrasound pulses on enzymatic activity of *S. cerevisiae*. Their results showed that the ultrasound pulse at low frequency (20–25 kHz) for a short sonification period of 1 and 2 min increased cell permeability, and the viability rate of yeasts was over 95%. However, in the 4 min sonification, the rate decreased to 46%.

The use of ultrasounds to stimulate biological activity and ethanol production by *S. cerevisiae* are reported by Schläfer et al. (2000). After testing several different frequencies and power levels, they carried out the experiments at 25 kHz, 0.3 and 12 W L⁻¹. At an ultrasound intensity of 12 W L⁻¹ there was no recognizable difference in the biological activity of yeasts with and without ultrasound. The authors stated that some pauses are needed between ultrasound exposure to obtain positive effects on biological activity of yeast *S. cerevisiae*. Moreover, an increase in biological activity appeared after irradiation and high activity of ultrasound activated cultures stopped for some hours after irradiation. The authors stated,

that discontinuous ultrasonic irradiation of *S. cerevisiae* was more beneficial for activating fermentation than the continuous exposure, because only a few steps in intracellular metabolisms are supported by ultrasound and others are not or even inhibited.

Liu et al. (2007) investigated the changes of biological activity of aerobic activated sludge after ultrasonic irradiation. The activity of microorganisms rose sharply after ultrasonic exposure of 0.3 W cm², 35 kHz for 10 min, and reached a peak level in 8 h after exposure (100% higher than that of the initial level immediately after exposure). Then it dropped rapidly in the next 8 h. In 24 h after ultrasonic irradiation, the enhancement effect induced by ultrasound almost disappeared, and the cells activity returned to the normal state as control cells without ultrasound stress. The authors stated that the enhancement might be due to defense response of microorganisms evoked by the mechanical stress. That reactions are usually observed when cells are challenged by biotic or abiotic stresses.

Pitt & Ross (2003) used ultrasonic irradiation to increase the growth rate of bacterial cells attached to a polyethylene surface. It was found that low frequency ultrasound (70 kHz) of low intensity (<2 W cm⁻²) increased the growth rate of the cells compared to growth without ultrasonic waves. They stated that ultrasounds can increase the rate of transport of oxygen and nutrients to the cells and the rate of transport of waste products away from the cells, thus enhancing their growth.

Xie et al. (2009) studied the enhancement effect of low-intensity ultrasound (35 kHz) on anaerobic sludge activity. The experiments showed, that the optimal ultrasonic intensity and irradiation period were 0.2 W cm² and 10 min, respectively.

To sum up, the optimal ultrasonic intensity and irradiation period are varied in each biological process enhanced by ultrasound and should be find experimentally.

3.2.2.2 Effect of HRT on ethanol fermentation

In order to estimate an optimal fermentation time under ultrasonic exposure in this study, parameters such as ethanol concentration, ethanol volumetric productivity, ethanol yield and lactose consumption were investigated.

The maximum values of ethanol concentration and lactose consumption were achieved when the HRT was 36 h. Under the HRT of 36 h in the ultrasound-assisted fermentation, the average ethanol concentration of 26.30 g L⁻¹, ethanol yield of 0.532 g g⁻¹ lactose and lactose consumption of 98,9% were obtained (Fig. 9-11). Using *S. cerevisiae* without ultrasound exposure gave the results as 23,60 g L⁻¹, 0.511 g g⁻¹, 92,4%, respectively and the differences were statistically significant (p<0.05). Shortening the HRT to 24 h allowed remaining high ethanol yield of 0.520 g g⁻¹ with sonicated *S. cerevisiae*, but in the control fermentation unit it was as low as 0.487 g g⁻¹ (p<0.05). When the HRT was 12 h the ethanol yields were 0.318 and 0.365 g g⁻¹ depending on using ultrasounds device (Fig. 11). From the economic viewpoint, shortening the fermentation time (HRT) could reduce costs of industrial ethanol production. The study showed that there is no need to extend the HRT over 36 h or more, because most of the lactose was converted into ethanol during 24 h (95.6% in the ultrasound-assisted fermentation. Nikolić et al. (2010) stated that optimal fermentation time for free and immobilized *S. cerevisiae* was 38 h. Ozmihi & Kargi (2008) studied ethanol production from cheese whey powder (CWP) solution containing 50 g sugar L⁻¹ at six different HRTs varying between 17.6 and 64.4 h by *Kluyveromyces marxianus* strains. Percent sugar utilization,

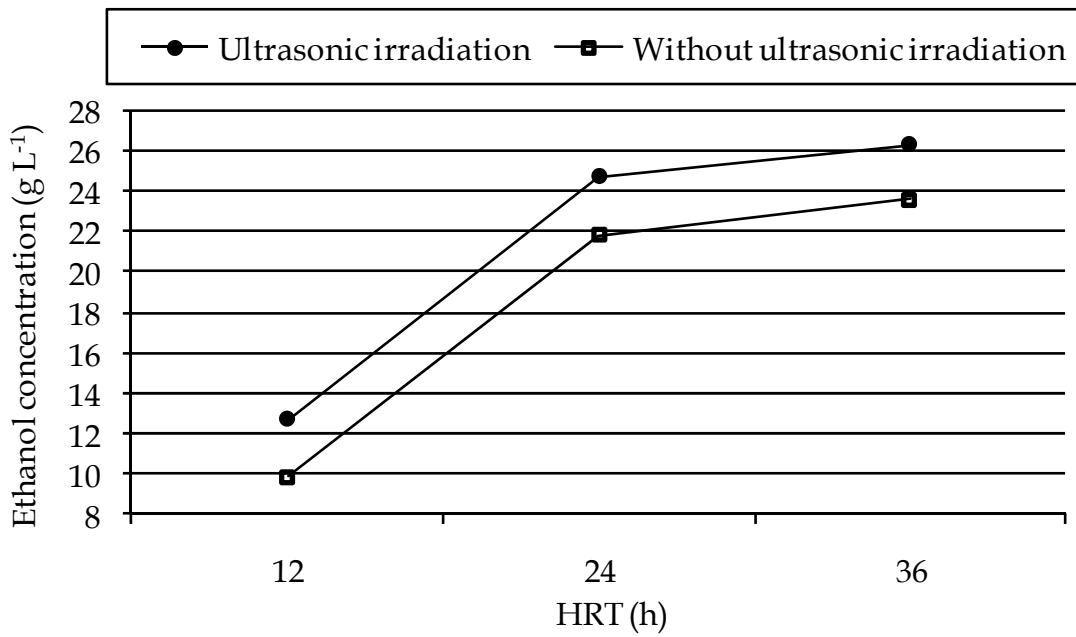

Fig. 9. Effects of HRT and ultrasound irradiation on the ethanol concentration

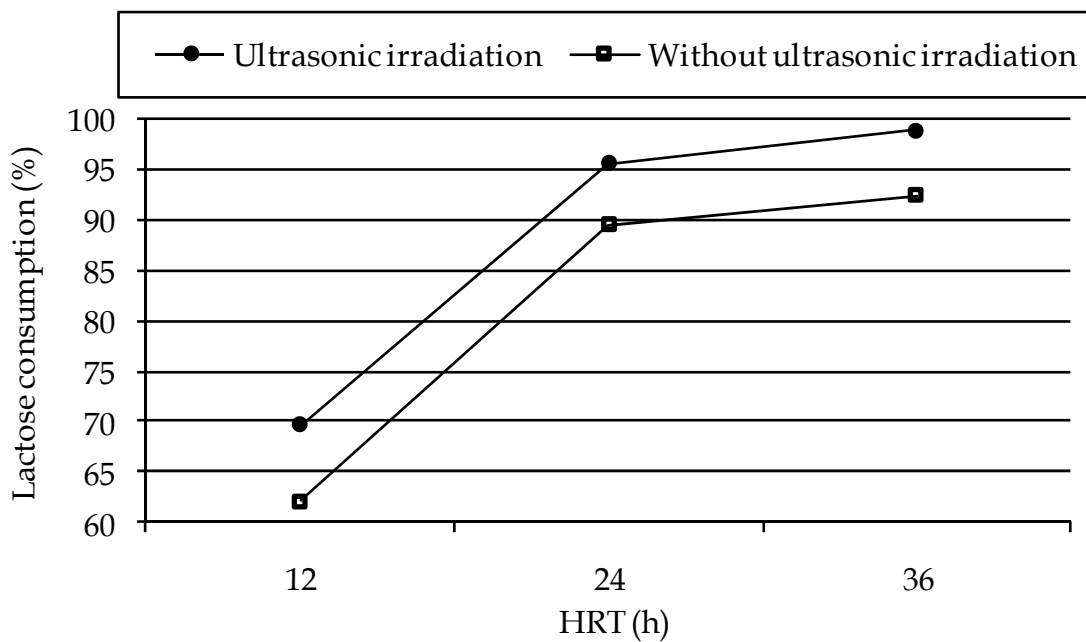

Fig. 10. Effects of HRT and ultrasound irradiation on the lactose consumption by co-immobilized *S. cerevisiae*

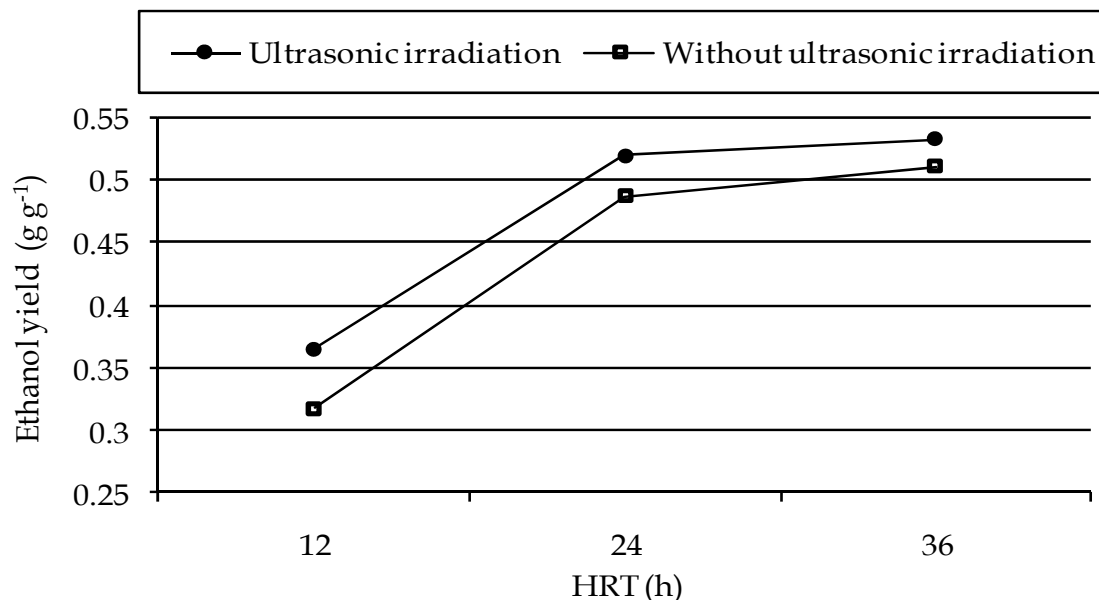

Fig. 11. Effect of HRT and ultrasound irradiation on the ethanol yield

effluent ethanol concentration and ethanol yield increased with increasing HRT from 17.6 to 50 h. Further increasing in HRT to 64.4 h resulted in decrease of the analyzed parameters. Moreover, the time for fermentation decreased at higher initial substrate concentration (Guimarães et al., 2008a; Nikolić et al., 2010; Ozmihci & Kargi, 2008). According to Guimarães et al. (2008a) the fermentations with 50-150 g lactose L⁻¹ reached completion in about the same time of 27 h but the maximum ethanol concentration increased linearly with increasing initial lactose concentration from 6.5 g ethanol L⁻¹ with 20 g lactose L⁻¹ to 57 g L⁻¹ with 200 g L⁻¹. They also stated that increasing lactose concentration led to incomplete fermentation and impair the fermentation due to nutrient limitation.

Interestingly, the volumetric productivities of ethanol decreased at longer HRT (Table 3). Maximum productivity of ethanol of 1.060 g L⁻¹ h⁻¹ was observed under the HRT of 12 h when the culture has been sonicated and 0.908 g L⁻¹ h⁻¹ under the HRT of 24 h in the fermentation process without ultrasound irradiation ($p < 0.05$). The volumetric ethanol productivity in the ultrasound-assisted fermentation obtained in this work was higher than that reported for batch or fed-batch fermentations with *S. cerevisiae* strains: 0.3 g L⁻¹ h⁻¹ (Rubio-Teixeira et al., 1998), 0.46 g L⁻¹ h⁻¹ (Guimarães et al., 2008b), 0.14 - 0.6 g L⁻¹ h⁻¹ (Ramakrishnan & Hartley, 1993), 1 g L⁻¹ h⁻¹ (Compagno et al., 1995). Ozmihci & Kargi (2007) using *Kluyveromyces marxianus* to ferment concentrated cheese whey powder solution obtained higher volumetric ethanol productivity over 2 g L⁻¹ h⁻¹, but after 120 h fermentation.

HRT	Ethanol volumetric productivity in the ultrasound-assisted fermentation system (g L ⁻¹ h ⁻¹)	Ethanol volumetric productivity in the control fermentation system (g L ⁻¹ h ⁻¹)
12 h	1.060	0.822
24 h	1.035	0.908
36 h	0.730	0.655

Table 3. Effects of HRT on the ethanol volumetric productivity

3.2.2.3 Effect of ultrasounds on ethanol fermentation

In all HRTs, significant higher ethanol productions in the ultrasound-assisted fermentation process than in the control fermentation process were recorded ($p < 0.05$). When the HRT was 12 h, the ethanol concentration without ultrasonic treatment was 9.87 g L^{-1} and it was significant lower by 2.85 g L^{-1} than the production in the process stimulated with low intensity ultrasounds ($p < 0.05$) (Fig. 9). Lactose consumption was only 62.1%, but application of ultrasound increased it to 69.7% ($p < 0.05$) (Fig. 10). The best results were obtained with the longest HRT of 36 h. Ethanol concentration increased to the value of 26.30 g L^{-1} when the culture has been sonicated, while in the fermentation process without ultrasound irradiation was only 23.60 g L^{-1} ($p < 0.05$), (Fig. 9). Lactose consumption was as high as 98.9% in ultrasound-assisted fermentation unit and was significant higher by 6.5% than the consumption in the reactor without ultrasonic irradiation ($p < 0.05$) (Fig. 10). High ethanol production and lactose consumption were observed with shortening HRT to 24 h. *S. cerevisiae* stimulated with low intensity ultrasound produced $24.85 \text{ g ethanol L}^{-1}$, while the lactose consumption was 95.6% (Fig. 9–10). In the control fermentation unit there was 21.79 g L^{-1} and 89.5%, respectively. The differences were statistically significant ($p < 0.05$). Under the HRT of 36 h, in the fermentation process with ultrasound irradiation the maximum ethanol yield of 0.532 g g^{-1} lactose was observed, whereas using biocatalyst *S. cerevisiae* without ultrasound exposure gave the result as 0.511 g g^{-1} (Fig. 11) ($p < 0.05$). Shortening the HRT to 24 h allowed remaining high ethanol yield of 0.520 g g^{-1} with sonicated *S. cerevisiae*, but in the control fermentation process it was as low as 0.487 g g^{-1} ($p < 0.05$). When the HRT was 12 h the ethanol yield was only 0.365 and 0.318 g g^{-1} , respectively ($p < 0.05$).

There were only few experiments investigating the enhancing ethanol production by ultrasonic stimulation of *S. cerevisiae*. Schläfer et al. (2000) improved biological activity of *S. cerevisiae* by low energy ultrasound assisted bioreactors operated at a frequency of 25 kHz and a power input of 0.3 W L^{-1} . The ethanol production without ultrasonic treatment varied between $3\text{--}12 \text{ g L}^{-1}$, while ultrasonic stimulation increased it to 30 g L^{-1} . The highest ethanol concentrations were obtained with a cycle regime of ultrasound exposure and a pause, because during continuous ultrasound irradiation no stimulation in the ethanol fermentation process was recorded.

Lanchun et al. (2003) investigated the influence of low intensity ultrasound on physiological characteristic of *S. cerevisiae*. The results of their study showed, that ultrasounds in the frequency of 24 kHz and the power efficiency of 2 W with 1 s irradiation time every 15 s and 30 min duration cycle, stimulated the material transport and improved the cell's metabolism by changing the osmotic pressure of membrane. Consequently, transfer of substance was speeded up, enzyme synthesis was driven up and enzyme activity was enhanced.

The positive results of the ultrasound treatment on the ethanol production by co-immobilized *S. cerevisiae* seemed to be a combination of different processes, including activating the yeast by improving the mass transfer rate of nutrients in the liquid, enhancing the uptake of foreign substances and the release of intracellular products in cells, improving the cell growth and degassing of CO_2 (Lanchun et al. 2003; Liu et al., 2007; Liu et al. 2003b). Stimulating enzyme activity is done by increasing in the mass transfer rate of the reagents to the active site (Liu et al., 2007). Ultrasounds irradiation can cause thermal and mechanical stress to biological materials (Liu et al., 2003b). High energy ultrasonic waves break the cells

and denature enzymes (Liu et al., 2007; Pitt & Ross, 2003). Low energy ultrasounds can produce a variety of effects on biological materials, including the inhibition or stimulation cellular metabolisms, enzyme activity, alteration of cell membranes and other cellular structures (Liu et al., 2007; Liu et al. 2003a). According to Xie et al. (2008), cavitation is the primary basis of biological effects of low intensity ultrasound. Cavitation bubbles produced by low intensity ultrasound can cause acoustic microstreaming (Xie et al., 2008). The microstreaming surrounding the cells can cause shear stress and enhance the mass transfer, which may stimulate metabolic activities inside the cells (Liu et al., 2003b; Pitt & Ross, 2003; Xie et al., 2008). When ultrasonic intensity is sufficiently low, a stable cavitation occurs and leads to the enhancement of mass transfer and fluid mixing, which produces positive effects on the rate of biological reactions in the exposure systems (Liu et al., 2007).

The growth activity of yeast cells is hardly changed within the early period of sonication regardless of either damage to cell wall, or complete inactivation of the yeast located in the cavitation zone (Tsukamoto et al., 2004). Short sonication time up to 5 min of irradiation indicated bactericidal effects, but the cells were able to repair the damages. According to Guerrero et al. (2005) yeasts, inclusive with *S. cerevisiae*, are highly resistant to ultrasound damage. Moreover, at relatively low intensity of ultrasounds, microorganisms can adapt to the irradiation exposure and their biological activity increases (Liu et al., 2007). With relatively short irradiation period, cell damage and membrane permeability induced by ultrasounds appear to be temporary and reversible. Lanchun et al. (2003) also stated that sonication cannot influence on fermentation strength of *S. cerevisiae* descendants.

3.2.3 Conclusions

The utilization of milk permeate to ethanol in continuous fermentation by co-immobilized *S. cerevisiae* is possible. The optimal ultrasonic intensity and irradiation period are varied in each biological process enhanced by ultrasound and should be find experimentally. According to this experiment, stimulation of yeasts activity could be achieved in the presence of low intensity ultrasound (1 W L⁻¹, 20 kHz), and 1 min every 6 h irradiation period is favorable to increase ethanol production efficiency. Moreover, the short exposure of yeast to ultrasound could reduce the operation costs comparing with continuous irradiation.

For the continuously operating bioreactors, the maximum rates of sugar utilization were 98.9 and 92.4% for the yeast with ultrasound exposure and without ultrasound exposure ($p < 0.05$), respectively. The maximum ethanol yield was 0.532 g g⁻¹ lactose, while using *S. cerevisiae* without ultrasound exposure 0.511 g g⁻¹. The study showed that there is no need to extend the HRT over 36 h or more, because most of the lactose was converted into ethanol during 24 h (95.6% in the ultrasound-assisted fermentation).

All results obtained here raises the new perspectives for disposal UF whey permeate.

4. Biohydrogen and methane production in two-stage fermentation process

Hydrogen is an eco-friendly, clean energy alternative because its combustion by-product is only water, so does not contribute to the greenhouse effect. Hydrogen has a high energy yield (122 kJ g⁻¹), therefore in recent times a great deal of attention is being paid to the usage

of hydrogen as a fuel. However, a major doubt on hydrogen as a clean energy alternative is that most of the hydrogen gas is currently generated from fossil fuels by thermochemical processes, such as hydrocarbon reforming, coal gasification and partial oxidation of heavier hydrocarbons (Castelló et al., 2009; Mohan et al., 2007). These methods are considered to be energy intensive and not environmental friendly. It is well known that only biological hydrogen production processes from the fermentation of renewable substrates, such as organic wastewater or other wastes are the promising alternative for hydrogen generation. Several strategies for the production of biohydrogen by fermentation in lab-scale have been found in the literature: photo-fermentation (Gadhamshetty et al., 2008), dark-fermentation (Krupp & Widmann, 2009) and combined-fermentation, which refers to the two fermentations combined (Nath & Das, 2009). However, no strategies for industrial scale productions have been found. In order to define the industrial scale biohydrogen production, more information from laboratory scale experiments are needed, especially related to design and optimization process, and operating parameters. Moreover, generation of biohydrogen by acidogenic phase of anaerobic process (dark-fermentation) is connected with incomplete degradation of organic material into organic acids, so there is a need to utilize by-products of the fermentation process.

As a result, the fermentative hydrogen production could be coupled with subsequent anaerobic digestion step with the conversion of remaining organic content to biogas. A two-stage fermentation process, in which acidogenesis and methanogenesis occur in the separate reactors may offer several advantages, such as improved total wastewater degradation and enhancing biohydrogen and methane production (Venetsaneas et al., 2009).

The dairy industry produces highly concentrated, carbohydrate-rich wastewaters, but their potential for biohydrogen generation has not been extensively studied. There were some experiences working with cheese whey as the substrate for biohydrogen production (Azbar et al. 2009; Castelló et al., 2009; Venetsaneas et al., 2009). The objectives of this work were: (1) to check the ability to produce biohydrogen using raw, unsterilized UF whey permeate, (2) to combine biohydrogen dark-fermentation process with methane fermentation of biohydrogen production by-products (mainly organic acids) in two-stage continuous fermentation process.

4.1. Materials and methods

4.1.1 Inoculum and wastewater

Anaerobic granular sludge from a full-scale UASB reactor treated fruit juice processing wastewater in fruit juice industry, Olsztynek, Poland, was used as an inoculum for biohydrogen and methane production. Prior to inoculation of the hydrogenogenic reactor, the granular sludge was washed with three volumes of tap water and then boiled for 2 h to inactivate hydrogen consuming microorganisms. A final concentration of inoculum was 151 g TSS L⁻¹. No pre-treatment of the granular sludge used for methane production was carried out prior to its inoculation in methanogenic reactor. Initial concentration of inoculum for methane production was 94 g TSS L⁻¹. Both reactors were initially inoculated at a ratio of 20% (by volume).

UF whey permeate was obtained from a cheese production factory in Nowy Dwór Gdański, Poland. It was received from the factory once a week, was stored at -20°C and was thawed

before used. The average composition of the feedstock was shown in Table 2. Prior to being fed into the reactor, the substrate was diluted with tap water to a COD concentration of 10,000 mg L⁻¹ in accordance with the required OLR (10 or 20 g COD L⁻¹ d⁻¹) in the hydrogenogenic reactor. Diluting UF whey permeate was maintained at a temperature 4°C until used.

4.1.2 Hydrogen production process setup and operation

A 5 L UASB reactor with 4.5 L working volume (R1) was made of stainless steel and cylindrical in shape (Fig. 12). The reactor was constantly stirred at 50 rpm. The pH of mixed liquid in R1 was controlled automatically with 6 M NaOH. The temperature in R1 was maintained at 37°C by inserting the reactor in the thermostatic chamber. For start-up, the reactor was filled with undiluted UF whey permeate and was operated anaerobically at a batch mode. When hydrogen production reached its peak value, the bioreactor feeding mode was turned to a continuous one at a HRT of 24 h (OLR of 10 g COD L⁻¹ d⁻¹) or at a HRT of 12 h (OLR of 20 g COD L⁻¹ d⁻¹). The R1 performance (biogas production and composition in H₂ and CH₄, COD, Total Volatile Fatty Acids - TVFA concentration, pH) was monitored twice a week throughout the experimental period (84 days).

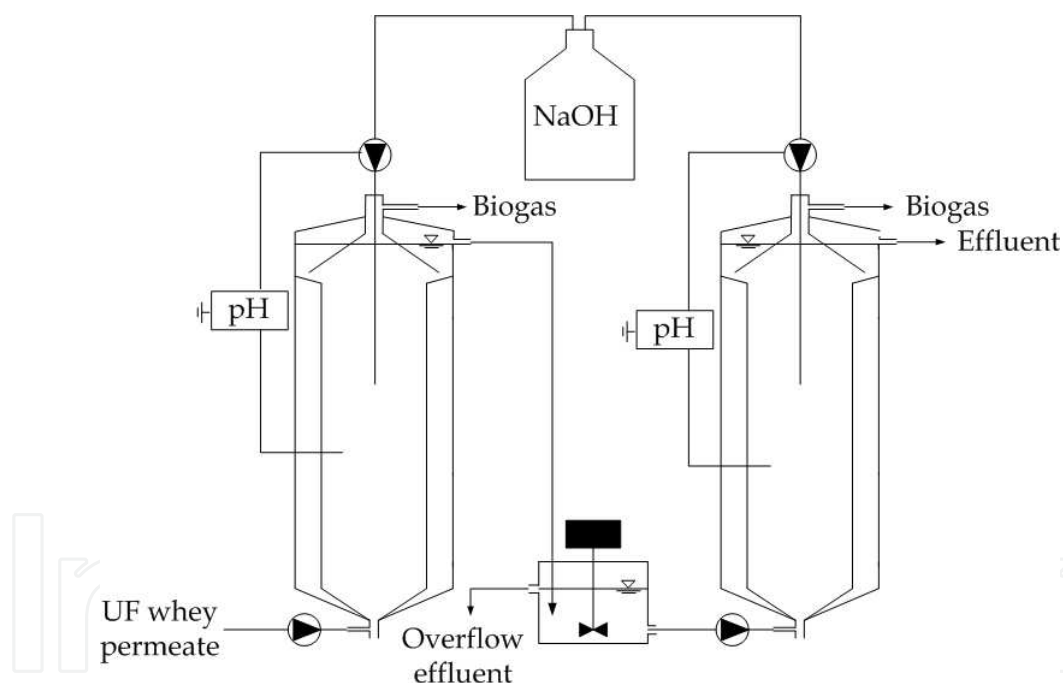

Fig. 12. Schematic of the two-stage fermentation system

4.1.3 Methane production process setup and operation

A 5 L UASB reactor with 4.5 L working volume (R2) was made of stainless steel and cylindrical in shape (Fig. 12). The reactor was constantly stirred at 50 rpm. The pH of mixed liquid in R2 was controlled automatically at pH 7.2 (± 0.05) with 6 M NaOH. The temperature in R2 was maintained at 37°C by inserting the reactor in the thermostatic chamber. The R2 was fed with the effluent from R1, which was collected in a 3 L container used as a storage tank which was constantly stirred at 50 rpm (Fig. 12). The temperature in

the tank was maintained at 37°C by placing it in the thermostatic chamber. Overflow effluent flowed out in the top part of the storage tank and was collected in a separate container. The R2 was operated at an HRT of 3 d. The R2 performance (biogas production and composition in CH₄, COD, TVFA concentration, pH) was monitored twice a week throughout the experimental period, from day 51 to 84. Before R2 was fed with R1 effluent, the diluted UF whey permeate had been used as a feedstock to reach the OLR of 2 g COD L⁻¹ d⁻¹ and HRT of 3 d.

4.1.4 Analytical methods

Determinations of COD, TSS, lactose, TVFA concentrations were carried out according to the Standard Methods for the Examination of Water and Wastewater (PN-74/C-04578.03; PN-78/C-04541; PN-67/A-86430; PN-75/C-04616.04). The measurement of the pH was continuously measured by the membrane electrodes, model ESAgP-301W, Eurosensor, placed in the liquid phase of reactor. Biogas composition (CH₄, H₂ and CO₂) was analyzed by using an electronic analyzer (Gas Data GFM 430, Gas Data Ltd.). Biogas production was measured with a water displacement meter.

4.2 Results and discussion

The hydrogenogenic reactor (R1) operation started with a HRT of 24 h, OLR of 10 g COD L⁻¹ d⁻¹ and pH 5.8. Under these conditions hydrogen production was as low as 0.12 L H₂ d⁻¹ (0.027 L H₂ L⁻¹ d⁻¹) (Fig. 13). It was noticed methane presence in biogas up to 19% v/v, while hydrogen concentration was still very low (up to 10% v/v). In order to inhibit methane production, the HRT was reduced to 12 h and OLR increased to 20 g COD L⁻¹ d⁻¹ on day 11. After 5 days, the HRT was increased to 24 h. Hydrogen content in biogas increased to the average value 15.7% v/v and methane was still present (<8% v/v). According to Yang et al. (2007), HRT shorter than 24 h does not favor the biohydrogen generation from cheese whey wastewater, but other researchers stated that short HRT could help to control the methanogenic reaction in hydrogenogenic phase (Castelló et al., 2009). Then, the HRT was again set at 12 h, OLR increased to 20 g COD L⁻¹ d⁻¹ and pH was decreased to 5.2 (day 24). It was seen that although the methanogenic bacteria was assumed to be washed out from the bioreactor under short HRT, the inhibition of methanogenic bacteria activity should be coupled with pH decrease. Liu et al. (2006) found that pH is the most critical factor for inhibition of methanogenesis and the optimum pH should be around 5.0 – 5.5. According to the literature, the optimum pH range for lactose (or whey) acidogenesis is between 6 and 6.5 (Venetsaneas et al. 2009). Antonopoulou et al. (2008) reported, that high concentration of hydrogen (over 25% v/v) in the gas phase was when the pH in the reactor was maintained at 5.2 ± 0.1. Wang et al. (2006) stated, that pH of 5.5 should be avoided in the biohydrogen fermentation process because at that level of pH, the propionic-acid type fermentation commonly occurred. The accumulation of propionic acid can lead to lower efficiency of methanogenic phase followed the hydrogenogenic phase. Mohan et al. (2007) found that pH 6 was the optimum for effective H₂ yield. However, maintaining pH at 6 or above is difficult because of large amounts of fatty acids generation. At this study, the pH in the hydrogenogenic reactor was initially maintained on the level of 5.8. As the pH was reduced down to 5.2 (coupled with HRT shortening and OLR increasing), methane content in biogas faded out.

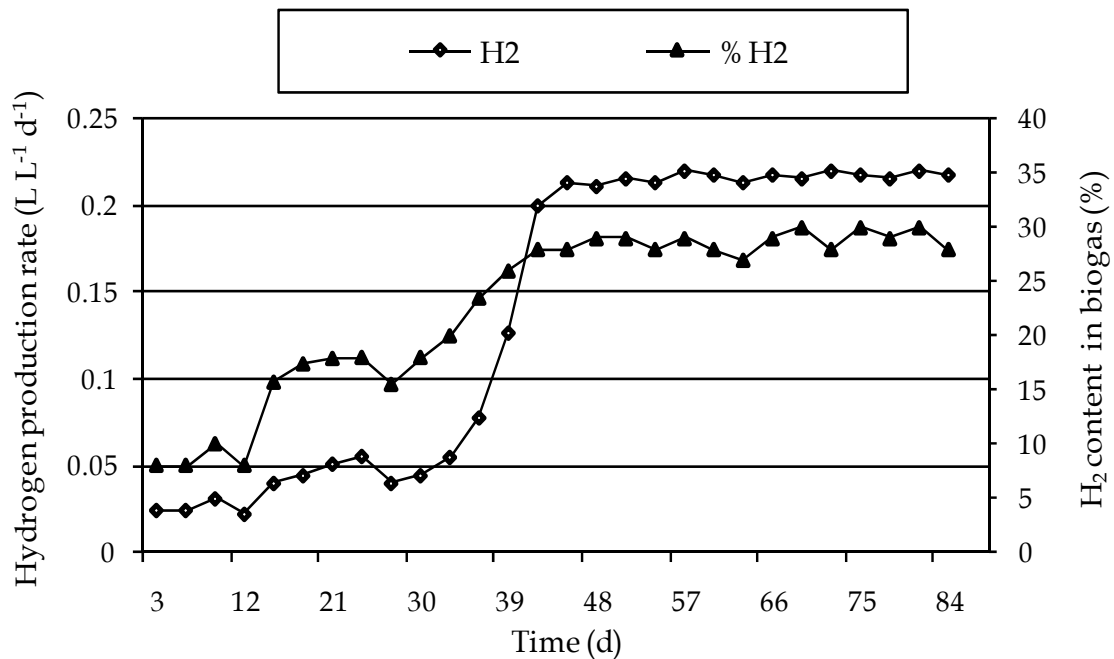

Fig. 13. Hydrogen production in R1 throughout the experimental period

The experimental results demonstrated by Azbar et al. (2009) showed that OLR did not result in any statistically significant change in hydrogen production rate from cheese whey when anaerobic reactors were operated using a range of OLR of 21, 35, 45 g COD L⁻¹ d⁻¹ and a constant HRT of 24 h. Moreover, lower HRT values (e.g. 1 d) increased hydrogen production rate. Mohan et al. (2007) found, that increasing OLR lead to periodic decreasing in biohydrogen production rate from dairy wastewater. This was attributed to the adaptation of microbial inoculum to higher substrate loading rate which is parallel to this results (Fig. 13). High substrate loading rate shows higher availability of substrate resulting in active substrate metabolism leading to higher H₂ yield (Mohan et al., 2007).

During the experiment, after reaching steady-state conditions (the standard deviations of monitored parameters were within 5%) on day 51, the average rate of hydrogen production was 0.97 L H₂ d⁻¹ (0.21 L H₂ L⁻¹ d⁻¹) (Fig. 13), hydrogen content in biogas increased to 29.8% v/v and methane was present in a low concentration (<1% v/v). Yang et al. (2007) reported hydrogen production ranging from 0.264 to 0.312 L H₂ L⁻¹ d⁻¹ (0.396 - 0.468 L H₂ d⁻¹) for OLR of 10 g COD L⁻¹ d⁻¹ and a HRT of 24 h using wastewater made from dry whey permeate powder. Biohydrogen contents in biogas fluctuated between 22 and 26% v/v. Castellò et al. (2009) obtained 0.55 L H₂ d⁻¹ (0.122 L H₂ L⁻¹ d⁻¹) for HRT of 12 h and OLR of 20 g COD L⁻¹ d⁻¹ from cheese whey. Biohydrogen content in biogas ranged from 20 to 30%. Hydrogen production between 0.3 and 7.9 L H₂ L⁻¹ d⁻¹ (2.5 L H₂ L⁻¹ d⁻¹ on average) from dairy wastewater was reported by Azbar et al. (2009). Venetsaneas et al. (2009) operated two-stage anaerobic reactors using cheese whey as a fermentation substrate. During the hydrogenogenic stage they achieved biohydrogen production rate of 0.96 L H₂ d⁻¹ (1.92 L H₂ L⁻¹ d⁻¹) and the percentage of hydrogen in the gas phase was 32.0±1.9% v/v (OLR 15 g COD L⁻¹ d⁻¹, HRT 24 h). Liu et al. (2006) achieved hydrogen production rate of 0.64 L H₂ d⁻¹ (1.6 L H₂ L⁻¹ d⁻¹) and hydrogen content in the biogas of 42% v/v from household solid waste in the two-stage fermentation process.

The effluent from R1 was collected in the storage tank from where it was pumped to the R2. The average pH at the outlet of R1 was 5.0 with a standard deviation of 0.3. According to the literature, optimum pH for methanogenic bacteria is between 6.0 and 7.5 (Mohan et al. 2007). In R2 the pH was maintained on the level of 7.2 (± 0.05). The R2 was fed with the R1 effluent from 51 day of experimental period, after the R1 had reached the steady-state. The average COD concentration of the R1 effluent was 5770 mg L⁻¹ thus the R2 reactor was operated at OLR of about 2 g COD L⁻¹ d⁻¹. The majority of COD was composed of VFA (total of all acids was 5147 mg L⁻¹ on average) generated during acidogenic fermentation step in R1. Fig. 14 shows the generation of biogas and methane produced throughout the experimental period. After the first 12 days, the reactor performance was stable and the average biogas and methane production rates were 3.0 L d⁻¹ (0.67 L L⁻¹ d⁻¹) and 2.2 L CH₄ d⁻¹ (0.47 L CH₄ L⁻¹ d⁻¹), respectively. The methane content in biogas approached 71% v/v. Venetsaneas et al. (2009) found that about 1 L CH₄ d⁻¹ was achieved in two-stage process for cheese whey fermentation resulting in 68% v/v methane production which is comparable to this study. The methanogenic digester was operated at an HRT of 20 d and OLR of 2.5 g COD L⁻¹ d⁻¹. Liu et al. (2006) achieved better methane production from household solid waste in the two-stage fermentation process of 11.5 L CH₄ d⁻¹ with a 65% v/v methane concentration in biogas.

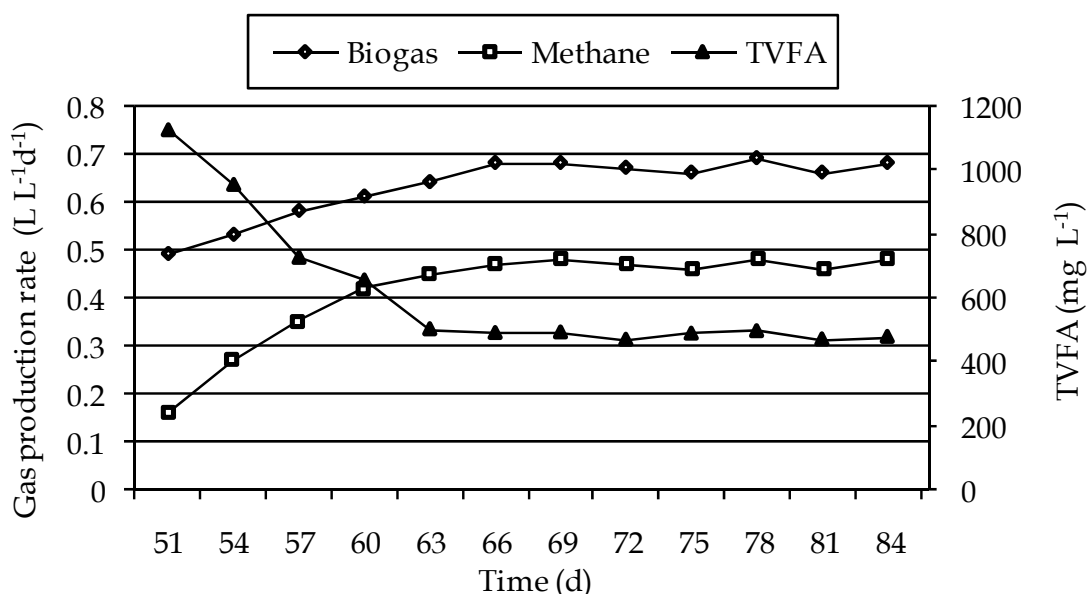

Fig. 14. Gas production and TVFA concentration in R2 throughout the experimental period

The two-stage fermentation system showed 95% of COD removal efficiency. Biohydrogen generation was connected with COD removal, thus the substrate degradation (as COD reduction) was 42.3% on average. It showed that more TVFAs were converted to biogas in the methanogenic stage. The concentration of remaining TVFAs in the effluent of R2 was 485 mg L⁻¹ on average.

During the study it was noticed a partial fermentation of raw UF whey permeate, although it was maintained at 4°C before used. VFA concentration increased periodically from 55 mg L⁻¹ to 2220 mg L⁻¹ after thawing for 20 hours. It seems that the UF whey permeate feedstock should be supplemented with NaHCO₃ to increase its alkalinity level before frozen (Castelló

et al., 2009). It allows to reduce the lactic acid concentration in the influent, because it was reported, that the conversion efficiency of lactic acid to hydrogen is much lower than that of glucose or sucrose (Guo et al. 2010). The coexistence of LAB (lactic acid bacteria) and the hydrogen producing bacteria was investigated by Noike et al. (2002). They found, that hydrogen fermentation was replaced by lactic acid fermentation caused by LAB present in the raw wastewater. Their inhibitory effect on hydrogen production could be explained by excretion of bacteriocins (Noike et al., 2002).

4.3 Conclusions

Raw, unsterilized UF whey permeate could be a substrate for biohydrogen production. Exploitation of UF whey permeate as a feedstock for H₂ and biogas production is an attractive and effective way of wastewater treatment with simultaneous renewable energy producing. Several factors influenced H₂ production in continuous bioreactors, especially pH of operation, HRT and OLR. The experiment showed, that pH 5.8 in the hydrogenogenic phase was not sufficient to inhibit the activity of methanogenic bacteria. Lower HRT values (<24 h) should be apply to eliminate methanogenic bacteria. Moreover, the regulation of pH in the hydrogenogenic reactor should be coupled with the influent pH adjustment in order to avoid lactic acid production in the raw wastewater. The HRT of 12 – 24 h and OLR of 10 – 20 g COD L⁻¹ d⁻¹ were found to be sufficient for effective H₂ yield.

This study demonstrated that biohydrogen production from UF whey permeate can be efficiently coupled with methane production in a subsequent step. For hydrogen production stage in stable conditions (HRT of 12 h, OLR of 20 g COD L⁻¹ d⁻¹, pH 5.2) hydrogen production rate was 0.97 L H₂ d⁻¹ and hydrogen content in the biogas reached 29,8% v/v. In the methanogenic step, the average biogas and methane production rates were 3.0 L d⁻¹ and 2.2 L CH₄ d⁻¹, respectively, while the methane content in biogas approached 71% v/v. The two-stage fermentation system reached 95% of COD removal efficiency.

The results of these investigations made the base for further studies to find the optimal operating conditions for higher biohydrogen production in UASB reactor in two-stage fermentation process with respect to determine the optimal OLR, HRT and pH parameters of the reactor giving stable long-term generation of H₂ from raw UF whey permeate.

5. General conclusions

Nowadays, an excessive use of fossil fuels has led to significant emissions of CO₂ in the atmosphere which is responsible for causing extensive climate changes (Socol et al., 2010). As a result of this with the increase in fossil fuel prices direct the efforts towards utilizing renewable energy sources. Considerable progress in searching for alternative energy sources has been made since the oil crisis of 1973. However, it must be noted that an only the renewable biomass used for energy production contributes to the reduction of negative environmental impacts, e.g. decreased GHG emissions.

Currently, commercial biofuels production, such as ethanol and biogas, relies mostly on the fermentation of cane sugar, molasses or glucose derived from corn, sugar beet, wheat or potatoes. It is not economically accepted because these biomass production for biofuels competes for the limited agricultural land needed for food and feed production. Much of the

hydrogen produced in the world is obtained from natural gas, which is not environmental friendly. Therefore, a significant increase in biofuels production would be possible only if technologies are developed to convert the waste biomass.

Dairy industry, like most other food industries, generates strong wastewaters characterized by high COD concentrations representing their high organic content (Demirel et al., 2005). Whey is by-product of milk processing and is abundantly obtained during cheese production. According to Najafpour et al. (2008), worldwide cheese production generates more than 145 million tonnes of liquid whey per year. In the case of deproteination of whey for the production of a valuable human food additive, the residual whey permeate is still a waste with high COD and must be treated before disposal. Due to its lactose major component, whey permeate is a well defined and suitable substrate for anaerobic digestion (Kourkoutas et al., 2002; Najafpour et al., 2008; Venetsaneas et al., 2009; Zafar & Owais, 2006). UF whey permeate fermentation in UASB reactors to produce biofuels (bioethanol, biogas, biohydrogen) has been successfully tested in this study.

6. Acknowledgements

The study of bioethanol production was supported by a grant N523 049 32/1753 from Ministry of Science and Higher Education, Poland in 2007 - 2008.

The study of biohydrogen production was supported by a grant N N 523 555138 from Ministry of Science and Higher Education, Poland in 2010 - 2013.

7. References

- Agricultural Market Agency (August 2009). Dairy Market in Poland (in Polish), ISBN 978-83-60012-74-1, Warsaw, Poland
- Aktaş, N.; Boyacı, İ.; Mutlu, M. & Tanyolaç A. (2006). Optimization of lactose utilization in deproteinated whey by *Kluyveromyces marxianus* using response surface methodology (RSM). *Bioresource Technology*, Vol.97, No.18, (December 2006), pp. 2252-2259, ISSN 0960-8524
- Angelidaki, I.; Ellegaard, L. & Ahring, B.K. (2003). Applications of the Anaerobic Digestion Process. Biomethanation II. *Advances in Biochemical Engineering/Biotechnology*, Vol.82, pp. 1-32, ISSN 0724-6145
- Antonopoulou, G.; Gavala, H.N.; Skiadas, I.; Angelopoulos, K. & Lyberatos, G. (2008). Biofuels generation from sweet sorghum: Fermentative hydrogen production and anaerobic digestion of the remaining biomass. *Bioresource Technology*, Vol.99, No.1, (January 2008), pp. 110-119, ISSN 0960-8524
- Azbar, N.; Dokgöz, F.; Keskin, T.; Korkmaz, K.S. & Syed, H.M. (2009). Continuous fermentative hydrogen production from cheese whey wastewater under thermophilic anaerobic conditions. *International Journal of Hydrogen Energy*, Vol.34, No.17, (September 2009), pp. 7441-7447, ISSN 0360-3199
- Balat M. & Balat H. (2009). Recent trends in global production and utilization of bio-ethanol fuel. *Applied Energy*, Vol.86, No.11, (November 2009), pp. 2273-2282, ISSN 0306-2619
- Castelló, E.; García y Santos, G.; Iglesias, T.; Paolino, G.; Wenzel, J.; Borzacconi, L. & Etchebehere, C. (2009). Feasibility of biohydrogen production from cheese whey using a UASB reactor: Links between microbial community and reactor

- performance. *International Journal of Hydrogen Energy*, Vol.34, No.14, (July 2009), pp. 5674-5682, ISSN 0360-3199
- Chisti, Y. (2003). Sonobioreactors: using ultrasound for enhanced microbial productivity. *Trends in Biotechnology*, Vol.21, No.2, (February 2003), pp. 89-93, ISSN 0167-7799
- Choung, Y.K. & Jeon, S.J. (2000). Phosphorus removal in domestic wastewater using anaerobic fixed beds packed with iron contactors. *Water Science and Technology*, Vol.41, No.1, pp. 241-244, ISSN 0273-1223
- Compagno, C.; Porro, D.; Smeraldi, C. & Ranzi, B.M. (1995). Fermentation of whey and starch by transformed *Saccharomyces cerevisiae* cells. *Applied Microbiology and Biotechnology*, Vol.43, No.5, (October 1995), pp. 822-825, ISSN 1432-0614
- Coté, A.; Brown, W.A.; Cameron, D. & van Walsum, G.P. (2004). Hydrolysis of lactose in whey permeate for subsequent fermentation to ethanol. *Journal of Dairy Science*, Vol. 87, No.6, (June 2004), pp. 1608-1620, ISSN 0022-0302
- de Glutz, F.N. (2009). Fuel bioethanol production from whey permeate. These EPFL No.4372, 24.04.2009, Available from: <http://biblion.epfl.ch/EPFL/theses/2009/4372/EPFL_TH4372.pdf>
- Demirel, B. ; Yenigun, O. & Onay T.T. (2005) Anaerobic digestion of dairy wastewaters : a review. *Process Biochemistry*, Vol.40, No.8., (July 2005), pp.2583-2595, ISSN 1359-5113
- Gadhamshetty, V.; Sukumaran, A.; Nirmalakhandan, N. & Myint, M.T. (2008). Photofermentation of malate for biohydrogen production - A modeling approach. *International Journal of Hydrogen Energy*, Vol.33, No.9, (May 2008), pp. 2138-2146, ISSN 0360-3199
- Ghaly, A.E. & El-Taweel, A.A. (1997). Kinetic modelling of continuous production of ethanol from cheese whey. *Biomass and Bioenergy*, Vol.12, No.6, pp. 461-472, ISSN 0961-9534
- Gnansounou, E. (2010). Production and use of lignocellulosic bioethanol in Europe: Current situation and perspectives. *Bioresource Technology*, Vol.101, No.13, (July 2010), pp. 4842-4850, ISSN 0960-8524
- Golubev, W.I. & Golubev, N.W. (2004). Selection and study of potent lactose-fermenting yeast. *Applied Biochemistry and Microbiology*, Vol.40, No.3, (May 2004), pp. 280-284, ISSN 0003-6838
- González Siso M.I. (1996). The biotechnology utilization of cheese whey: a review. *Bioresource Technology*, Vol.57, No.1, (July 1996), pp. 1-11, ISSN 0960-8524
- Guerrero, S.; Tognon, M. & Alzamora, S.M. (2005). Response of *Saccharomyces cerevisiae* to the combined action of ultrasound and low weight chitosan. *Food Control*, Vol.16, No.2, (February 2005), pp. 131-139, ISSN 0956-7135
- Guimarães, P.M.R.; François, J.; Parrou, J.L.; Teixeira, J.A. & Domingues L. (2008a). Adaptive evolution of a lactose-consuming *Saccharomyces cerevisiae* recombinant. *Applied and Environmental Microbiology*, Vol.74, No.6, (March 2008), pp. 1748-1756, ISSN 1098-5336
- Guimarães, P.M.R.; Teixeira, J.A. & Domingues L. (2008b). Fermentation of high concentrations of lactose to ethanol by engineered flocculent *Saccharomyces cerevisiae*. *Biotechnology Letters*, Vol.30, No.11, (November 2008), pp. 1953-1958, ISSN 1573-6776

- Guo, X.M.; Trably, E.; Latrille, E.; Carrère, H. & Steyer, J.P. (2010). Hydrogen production from agricultural waste by dark fermentation: A review. *International Journal of Hydrogen Energy*, Vol.35, No.19, (October 2010), pp. 10660-10673, ISSN 0360-3199
- Jeon, S.J.; Kim, H.S. & Lee, Y.W. (2003). Effect of iron media on the treatment of domestic wastewater to enhance nutrient removal efficiency. *Process Biochemistry*, Vol.38, No.12, (July 2003), pp. 1767-1773, ISSN 1359-5113.
- Kargi, F. & Ozmiş, S. (2006). Utilization of cheese whey powder (CWP) for ethanol fermentations: Effects of operating parameters. *Enzyme and Microbial Technology*, Vol.38, No.5, (March 2006), pp. 711-718, ISSN 0141-0229
- Karri, S.; Sierra-Alvarez, R. & Field J.A. (2005). Zero valent iron as an electron-donor for methanogenesis and sulfate reduction in anaerobic sludge. *Biotechnology and Bioengineering*, Vol.92, No.7., (December 2005), pp. 810-819, ISSN 1097-0290
- Kourkoutas, Y.; Dimitropoulou, S.; Kanellaki, M.; Marchant, R.; Nigam, P.; Banat, I.M. & Koutinas, A.A. (2002). High-temperature alcoholic fermentation of whey using *Kluyveromyces marxianus* IMB3 yeast immobilized on delignified cellulosic material. *Bioresource Technology*, Vol. 82, No.2, (April 2002), pp. 177-181, ISSN 0960-8524
- Kourkoutas, Y.; Bekatorou, A.; Banat, I.M.; Marchant, R. & Koutinas, A.A. (2004). Immobilization technologies and support materials suitable in alcohol beverages production: a review. *Food Microbiology*, Vol.21, No.4, (August 2004), pp. 377-397, ISSN 0740-0020
- Krupp, M. & Widmann, R. (2009). Biohydrogen production by dark fermentation: Experiences of continuous operations in large lab scale. *International Journal of Hydrogen Energy*, Vol.34, No.10, (May 2009), pp. 4509-4516, ISSN 0360-3199
- Lai, P.; Zhao, H.Z.; Wang, C. & Ni, J.R. (2007). Advanced treatment of coking wastewater by coagulation and zero-valent iron processes. *Journal of Hazardous Materials*, Vol.147, No.1-2, (August 2007), pp. 232-239, ISSN 0304-3894
- Lanchun, S.; Bochu, W.; Liancai, Z.; Jie, L.; Yanhong, Y. & Chuanren, D. (2003). The influence of low-intensity ultrasonic on some physiological characteristics of *Saccharomyces cerevisiae*. *Colloids and Surfaces B: Biointerfaces*, Vol.30, No.1, (July 2003), pp. 61-66, ISSN 0927-7765
- Lewandowska, M. & Kujawski, W. (2007). Ethanol production from lactose in a fermentation/pervaporation system. *Journal of Food Engineering*, Vol.79, No.2, (March 2007), pp. 430-437, ISSN 0260-8774
- Ling, K.Ch. (2008). Whey to Ethanol: A Biofuel Role for Dairy Cooperatives?, *Research Report 214, USDA Rural Development, US Department of Agriculture (USDA)*, Washington 2008, Available from: < <http://www.rurdev.usdu.gov/rbs/pub/RR214.pdf>>
- Liu, D.; Liu, D.; Zeng, R.J. & Angelidaki, I. (2006). Hydrogen and methane production from household solid waste in the two-stage fermentation process. *Water Research*, Vol.34, No.11, (June 2006), pp. 2230-2236, ISSN 0043-1354
- Liu, H.; Yan, Y.; Wang, W. & Yu, Y. (2007). Low intensity ultrasound stimulates biological activity of aerobic activated sludge. *Frontiers of Environmental Science & Engineering in China*, Vol.1, No.1, (February 2007), pp. 67-72, ISSN 1673-7520
- Liu, Y.; Takatsuki, H.; Yoshikoshi, A.; Wang, B.C. & Sakanishi A. (2003a). Effects of ultrasound on the growth and vacuolar H⁺-ATPase activity of aloe *arborescens* callus cells. *Colloids and Surfaces B: Biointerfaces*, Vol.32, No.2, (October 2003), pp. 105-116, ISSN0927-7765

- Liu, Y.; Yoshikoshi, A.; Wang, B.C. & Sakanishi A. (2003b). Influence of ultrasonic stimulation on the growth and proliferation of *Oryza sativa* Nipponbare callus cells. *Colloids and Surfaces B: Biointerfaces*, Vol.27, No.4, (March 2003), pp. 287-293, ISSN 0927-7765
- Marques, L. L. M.; Buzato, J.B. & Celligoi, M.A.P.C. (2006). Effect of raffinose and ultrasound pulses on invertase release by free and immobilized *Saccharomyces cerevisiae* in loofa (*Luffa cylindrica*) sponge. *Brazilian Archives of Biology and Technology*, Vol.49, No. 6, (November 2006), pp. 873-880, ISSN 1516-8913
- Meyer-Aurich, A.; Schattauer, A.; Hellebrand, H.J.; Klauss, H.; Plöchl, M. & Berg, W. (2012). Impact of uncertainties on greenhouse gas mitigation potential of biogas production from agricultural resources. *Renewable Energy*, Vol.37, No.1, (January 2012), pp. 277-284, ISSN 0960-1481
- Mohan, S.V.; Babu, V.L. & Sarma, P.N. (2007). Anaerobic biohydrogen production from dairy wastewater treatment in sequencing batch reactor (AnSBR): Effect of organic loading rate. *Enzyme and Microbial Technology*, Vol.41, No.4, (September 2007), pp. 506-515, ISSN 0141-0229
- Muthaiyan, A. & Ricke S.C. (2010). Current perspectives on detection of microbial contamination in bioethanol fermentors. *Bioresource Technology*, Vol.101, No.13, (July 2010), pp. 5033-5042, ISSN 0960-8524
- Najafpour, G.D., Hashemiyeh, B.A., Asadi, M. & Ghasemi, M.B. (2008). Biological treatment of dairy wastewater in an Upflow Anaerobic Sludge-Fixed Film Bioreactor. *American-Eurasian Journal of Agricultural and Environmental Sciences*, Vol.4, No.2, pp. 251-257, ISSN 1818-6769
- Nath, K. & Das, D. (2009). Effect of light intensity and initial pH during hydrogen production by an integrated dark and photofermentation process. *International Journal of Hydrogen Energy*, Vol.34, No.17, (September 2009), pp. 7497-7501, ISSN 0360-3199
- Nikolić, S.; Mojović, L.; Pejin, D.; Rakin, M. & Vukašinić, M. (2010). Production of bioethanol from corn meal hydrolyzates by free and immobilized cells of *Saccharomyces cerevisiae* var. *ellipsoideus*. *Biomass and Bioenergy*, Vol.34, No.10, (October 2010), pp. 1449-1456, ISSN 0961-9534
- Noike, T.; Takabatake, H.; Mizuno, O. & Ohba, M. (2002). Inhibition of hydrogen fermentation of organic wastes by lactic acid bacteria. *International Journal of Hydrogen Energy*, Vol.27, No.11-12, (November-December 2002), pp. 1367-1371, ISSN 0360-3199
- Ozmiñci, S. & Kargi, F. (2007). Kinetics of batch ethanol fermentation of cheese-whey powder (CWP) solution as function of substrate and yeast concentrations. *Bioresource Technology*, Vol.98, No.16, (November 2007), pp. 2978-2984, ISSN 0960-8524
- Ozmiñci, S. & Kargi, F. (2008) Ethanol production from cheese whey powder solution in a packed column bioreactor at different hydraulic residence times. *Biochemical Engineering Journal*, Vol.42, No.1, (November 2008), pp. 180-185, ISSN 1369-703X
- Pitt, W.G. & Ross S.A. (2003) Ultrasound increases the rate of bacterial cell growth. *Biotechnology Progress*, Vol.19, No.3, (January 2003), pp. 1038-1044, ISSN 1520-1633

- Pöschl, M.; Ward, S. & Owende, P. (2010). Evaluation of energy efficiency of various biogas production and utilization pathways. *Applied Energy*, Vol.87, No.11, (November 2010), pp. 3305-3321, ISSN 0306-2619
- Prochnow, A.; Heiermann, M.; Plöchi, M.; Linke, B.; Idler, C.; Amon, T. & Hobbs, P.J. (2009). Bioenergy from permanent grassland – A review: 1. Biogas. *Bioresource Technology*, Vol.100, No.21, (November 2009), pp. 4931-4944, ISSN 0960-8524
- Ramakrishnan, S. & Hartley, B.S. (1993). Fermentation of lactose by yeast cells secreting recombinant fungal lactase. *Applied and Environmental Microbiology*, Vol.59, No.12, (December 1993), pp. 4230-4235, ISSN 1098-5336
- Rubio-Teixeira, M.; Castrillo, J.I.; Adam, A.C.; Ugalde, U.O. & Polaina, J. (1998). Highly efficient assimilation of lactose by a metabolically engineered strain of *Saccharomyces cerevisiae*. *Yeast*, Vol. 14, No.9, (June 1998), pp. 827-837, ISSN 1097-0061
- Sarkar, N.; Ghosh, S.K.; Bannerjee, S. & Aikat, K. (2012). Bioethanol production from agricultural wastes: An overview. *Renewable Energy*, Vol.37, No.1, (January 2012), pp. 19-27, ISSN 0960-1481
- Schläfer, O.; Sievers, M.; Klotzbücher, H. & Onyeche, T.I. (2000). Improvement of biological activity by low energy ultrasound assisted bioreactors. *Ultrasonics*, Vol.38, No.1-8, (March 2000), pp. 711-716, ISSN 0041-624X
- Silveira, W.B.; Passos, F.J.W.; Mantovani, H.C.; Passos F.M.L. (2005). Ethanol production from cheese whey permeate by *Kluyveromyces marxianus* UFV-3: A flux analysis of oxido-reductive metabolism as a function of lactose concentration and oxygen levels. *Enzyme and Microbial Technology*, Vol.36, No.7, (May 2005), pp. 930-936, ISSN 0141-0229
- Socol, C.; Vandenberghe, L. & Medeiros A. (2010). Bioethanol from lignocelluloses: status and perspectives in Brazil. *Bioresource Technology*, Vol.101, No.13, (July 2010), pp. 4820-4825, ISSN 0960-8524
- Stephenson, A.L.; Dupree, P.; Scott, S.A.; Dennis, J.S. (2010). The environmental and economic sustainability of potential bioethanol from willow in the UK. *Bioresource Technology*, Vol.101, No.24, (December 2010), pp. 9612-9623, ISSN 0960-8524
- Tsukamoto, I.; Constanyinoiu, E.; Furuta, M.; Nishimura, R. & Maeda, Y. (2004). Inactivation effect of sonication and chlorination on *Saccharomyces cerevisiae*. Calorimetric Analysis. *Ultrasonics Sonochemistry*, Vol.11, No.3-4, (May 2004), pp. 167-172, ISSN 1350-4177
- Van Ginkel, S.; Oh, S. & Logan B. (2005). Biohydrogen gas production from food processing and domestic wastewater. *International Journal of Hydrogen Energy*, Vol.30, No.15, (December 2005), pp. 1535-1542, ISSN 0360-3199
- Venetsaneas, N.; Antonopoulou, G.; Stamatelatos, K.; Kornaros, M. & Lyberatos, G. (2009). Using cheese whey for hydrogen and methane generation in a two-stage continuous process with alternative pH controlling approaches. *Bioresource Technology*, Vol.100, No.15, (August 2009), pp. 3713-3717, ISSN 0960-8524
- Vlyssides, A.; Barampouti, E.M. & Mai S. (2009). Influence of ferrous iron on the granularity of a UASB reactor. *Chemical Engineering Journal*, Vol.146, No.1, (January 2009), pp. 49-56, ISSN 1385-8947

- Volkland, H.P.; Harms, H., Wanner, O. & Zehnder, A.J.B. (2001). Corrosion protection by anaerobiosis. *Water Science and Technology*, Vol.44, No.8, pp. 103-106, ISSN 0273-1223
- Wang, L.; Zhou, Q. & Li, F.T. (2006). Avoiding propionic acid accumulation in the anaerobic process for biohydrogen production. *Biomass and Bioenergy*, Vol.30, No.2, (February 2006), pp. 177-182, ISSN 0961-9534
- Xie, B.; Liu, H. & Yan Y. (2009). Improvement of the activity of anaerobic sludge by low-intensity ultrasound. *Journal of Environmental Management*, Vol.90, No.1, (January 2009), pp. 206-264, ISSN 0301-4797
- Xie, B.; Wang, L. & Liu, H. (2008). Using low intensity ultrasound to improve the efficiency of biological phosphorus removal. *Ultrasonics Sonochemistry*, Vol.15, No. 5, (July 2008), pp. 775-781, ISSN 1350-4177
- Yadvika, S.; Sreekrishnan, T.R.; Kohli, S. & Rana, V. (2004). Enhancement of biogas production from solid substrates using different techniques - a review. *Bioresource Technology*, Vol.95, No.1, (October 2004), pp. 1-10, ISSN 0960-8524
- Yang, P.; Zhang, R.; McGarvey, J.A. & Benemann, J.R. (2007). Biohydrogen production from cheese processing wastewater by anaerobic fermentation using mixed microbial communities. *International Journal of Hydrogen Energy*, Vol.32, No.18, (December 2007), pp. 4761-4771, ISSN 0360-3199
- Yu, H.Q.; Fang, H.H.P. & Tay J.H. (2000). Effects of Fe²⁺ on sludge granulation in upflow anaerobic sludge blanket reactors. *Water Science and Technology*, Vol.41, No.12, pp. 199-205, ISSN 0273-1223
- Zafar, S. & Owais, M. (2006). Ethanol production from crude whey by *Kluyveromyces marxianus*. *Biochemical Engineering Journal*, Vol.27, No.3, (January 2006), pp. 295-298, ISSN 1369-703X

IntechOpen

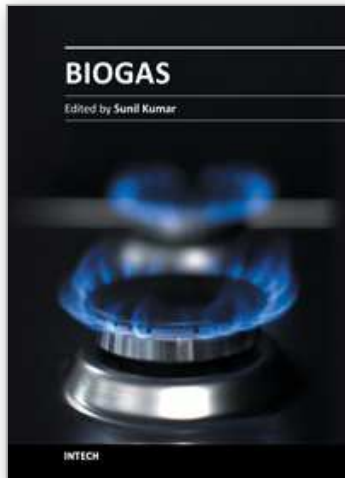

Biogas

Edited by Dr. Sunil Kumar

ISBN 978-953-51-0204-5

Hard cover, 408 pages

Publisher InTech

Published online 14, March, 2012

Published in print edition March, 2012

This book contains research on the chemistry of each step of biogas generation, along with engineering principles and practices, feasibility of biogas production in processing technologies, especially anaerobic digestion of waste and gas production system, its modeling, kinetics along with other associated aspects, utilization and purification of biogas, economy and energy issues, pipe design for biogas energy, microbiological aspects, phyto-fermentation, biogas plant constructions, assessment of ecological potential, biogas generation from sludge, rheological characterization, etc.

How to reference

In order to correctly reference this scholarly work, feel free to copy and paste the following:

Marta Kisielewska (2012). Feasibility of Bioenergy Production from Ultrafiltration Whey Permeate Using the UASB Reactors, *Biogas*, Dr. Sunil Kumar (Ed.), ISBN: 978-953-51-0204-5, InTech, Available from: <http://www.intechopen.com/books/biogas/feasibility-of-bioenergy-production-from-ultrafiltration-whey-permeate-using-the-uasb-reactors>

INTECH
open science | open minds

InTech Europe

University Campus STeP Ri
Slavka Krautzeka 83/A
51000 Rijeka, Croatia
Phone: +385 (51) 770 447
Fax: +385 (51) 686 166
www.intechopen.com

InTech China

Unit 405, Office Block, Hotel Equatorial Shanghai
No.65, Yan An Road (West), Shanghai, 200040, China
中国上海市延安西路65号上海国际贵都大饭店办公楼405单元
Phone: +86-21-62489820
Fax: +86-21-62489821

© 2012 The Author(s). Licensee IntechOpen. This is an open access article distributed under the terms of the [Creative Commons Attribution 3.0 License](#), which permits unrestricted use, distribution, and reproduction in any medium, provided the original work is properly cited.

IntechOpen

IntechOpen