

We are IntechOpen, the world's leading publisher of Open Access books Built by scientists, for scientists

4,800

Open access books available

122,000

International authors and editors

135M

Downloads

Our authors are among the

154

Countries delivered to

TOP 1%

most cited scientists

12.2%

Contributors from top 500 universities



WEB OF SCIENCE™

Selection of our books indexed in the Book Citation Index
in Web of Science™ Core Collection (BKCI)

Interested in publishing with us?
Contact book.department@intechopen.com

Numbers displayed above are based on latest data collected.
For more information visit www.intechopen.com



Measurement and Modeling Techniques for the Fourth Generation Broadband Over Copper

Diogo Acatauassu¹, Igor Almeida¹, Francisco Muller¹, Aldebaro Klautau¹,
Chenguang Lu², Klas Ericson² and Boris Dortschy²

¹*Federal University of Pará*

²*Ericsson AB*

¹*Brazil*

²*Sweden*

1. Introduction

Digital subscriber lines (DSL), the broadband data transmission technologies that use the copper cable as channel, are the most used Internet media around the world with more than 300 million users (Oksman et al., 2010). Much of the DSL success is related to the cost-benefit for both operators and served consumers. As the transmission channel is the common copper twisted-pair telephone cable, there is no need for large investments in infrastructure, because the telephone network is largely consolidated and active in almost all the world.

Over the years, DSL systems suffered a step-by-step evolution, being divided in different generations according to the increase of its data rates and technology improvements (Odling et al., 2009). A lot of elements were evolved in this process. Two of them can be highlighted. The first one was the development of modern signal processing techniques to avoid crosstalk effects in DSL transmissions, such as the so-called dynamic spectrum management (DSM) techniques (Cendrillon & Moonen, 2005; Moraes et al., 2010; Oksman et al., 2010; Song et al., 2002). The second one was the reduction of the used copper cable length, resulting in a consequent reduction in the attenuation imposed on the transmission signals. This fact allowed the increase of the used bandwidths, and consequently the data rates.

The standards of the first and the second generations DSL, matching the integrated services digital network (ISDN) (ITU-T, 1991) and asymmetric DSL (ADSL) family (ITU-T, 1999a; 2003; 2005a), were developed to operate over several kilometers copper cables achieving maximum data rates up to 20 Mb/s. The standards of the third generation DSL, matching the very high speed DSL (VDSL) family (ITU-T, 2005b; 2006), were developed to operate over hundred meters copper cables, achieving maximum data rates up to 100 Mb/s. This case, when users do not live near to the service provider's central office, fiber to street cabinets (FTTC) are inevitable to make the copper loop sufficiently short (van den Brink, 2010).

The fourth generation DSL systems will try to explore the copper twisted-pair cable to the maximum, reducing it to few meters and joining it to hybrid optical fiber access architectures, such as fiber to the home (FTTH) (Magesacher et al., 2006; Odling et al., 2009; van den Brink, 2010). The copper cable length reduction process will allow unused frequencies, far above the 30 MHz VDSL2. Recent works described that this frequency values can achieve 100 MHz (Magesacher et al., 2006; Odling et al., 2009; van den Brink, 2010), even reaching 300 MHz, depending on the quality of the used cable (van den Brink, 2010). Results of capacity simulations showed that this transmission channels can achieve near 1 Gb/s, and the use of DSM techniques to avoid crosstalk effects can help ensuring these data rates (Acatauassu et al., 2009; Magesacher et al., 2006; Odling et al., 2009).

It is important to notice that the use of FTTH does not necessary mean that fiber is deployed all the way to a point inside the home. The costs for installation, digging and putting the fiber into every subscriber house are so significant that the required investment is disproportional to the current market (Odling et al., 2009; van den Brink, 2010; Vergara et al., 2010) making it impracticable. So, there will be, in most cases, a lack for the last 50-300m transmission channel, which can be easily used by the existing telephony wiring. To know the behavior of short copper cables, transmitting data in unexplored frequencies, is essential to the development and implementation of the fourth generation DSL systems, and is the focus of this chapter.

The text describes a measurement campaign, that was performed in order to obtain the direct transfer functions and far-end crosstalk transfer functions of 50m, 100m and 200m copper cables. The description of the measurement techniques includes the used equipments, the experimental setup and the reference parameters used during the experiments. Moreover, this chapter introduces a simple procedure for fitting a well-know copper cable model, commonly used for performance evaluation of current DSL standards. The obtained fitted model was compared to the results of the short copper cable measurements, and showed good performance, indicating it can be used in frequency domain-based simulations. In fact, as another contribution, this chapter describes some preliminary simulations results in order to evaluate the fourth generation DSL systems performance, in terms of achievable data rates, optimization of transmission parameters and verification of the rates degradation due to the effects of uncanceled crosstalk.

The text is organized as follows, Section 2 briefly describes the state of art and the standardization effort held by the International Telecommunication Union for the fourth generation DSL systems. Section 3 describes the well-known theory behind the twisted-pair copper cable characterization, and shows some cable reference models used for performance evaluation of the current DSL standards. Section 4 describes a measurement campaign, performed in order to characterize the quality of short copper cables in terms of direct transfer functions (which are related to the loop attenuation) and crosstalk transfer functions (which describe signal leakages of twisted-pairs inside the cables). Continuing, Section 5 describes a modeling technique based on fitting the simplified twisted-pair copper cable model, which is commonly used for performance evaluation of current DSL standards. The data obtained by the developed fitted model is then compared to the results obtained by the short cable measurements. Section 6 shows some preliminary simulations in order to evaluate the performance of the fourth generation DSL systems, including the verification of the achievable data rates and optimization of transmission parameters, and, finishing, Section 7 describes the conclusions of the chapter.

2. State of art and standardization of the fourth generation DSL

Recently, the International Telecommunication Union (ITU) started the fourth generation broadband over copper standardization under the working name G.Fast, where Fast means Fast Access to Subscriber Terminals (van den Brink, 2010). It came due to the desire of Telcos, industries and universities, which observed the potential of this technology, based mainly by the economic point of view. As the costs for installation, digging and putting optical fiber into the ground for every broadband subscriber are so significant, the required investment becomes disproportional to the current market demand (Odling et al., 2009; van den Brink, 2010), so there is a gap that can be bypassed by using the existing telephone wiring.

A comparison between the fourth generation DSL proposal and older DSL generations, in terms of desirable data rates, transmission bandwidth and typical length of the used copper cable is illustrated in Figure 1.

Some initial available works describing the research on the fourth generation broadband over copper can be find in (Acatauassu et al., 2009; Magesacher et al., 2006; Odling et al., 2009; van den Brink, 2010).

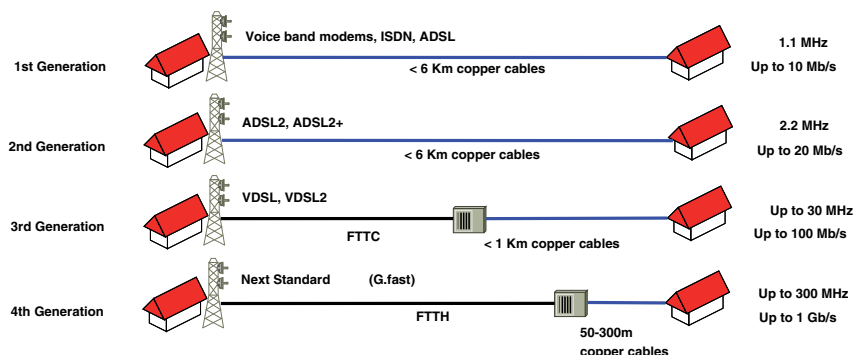

Fig. 1. Comparison of DSL Generations.

3. Twisted-pair copper cables characterization theory

A key point of any communication system, does not matter if wireline or wireless, is to characterize the transmission channel. Copper cables have been used by communication systems for more than a century (Chen, 1998), and play the role of transmission channel in DSL systems.

Twisted-pair copper cables are usually bundled together in a cable sheath with 25 to 100 twisted-pairs. Each wire is also coated with some type of insulating material such as a paper-based (PULP) or a plastic-based (PIC) material. The rate of twisting is usually in the range of 12 to 40 turns per meter. They are also characterized by the diameter of the copper wire (gauge). The ETSI (European Telecommunications Standards Institute) defines the gauges in millimeters, with diameters ranging from 0.9mm to 0.32mm. The ANSI (American National Standards Institute) defines the gauges using the American Wire Gauge (AWG) designation, with typical values ranging from 19 AWG to 26 AWG (Chen, 1998; Yoho, 2001).

The electrical characteristics of twisted-pair copper cables are defined using the classical transmission line model, which can be described by an equivalent circuit built up with four frequency-dependent parameters: series resistance R , series inductance L , shunt capacitance C and shunt conductance G . The RLGC parameters are known as primary parameters (Chen,

1998). Figure 2 illustrates the transmission line model of a segment of copper twisted-pair, per unit length dz .

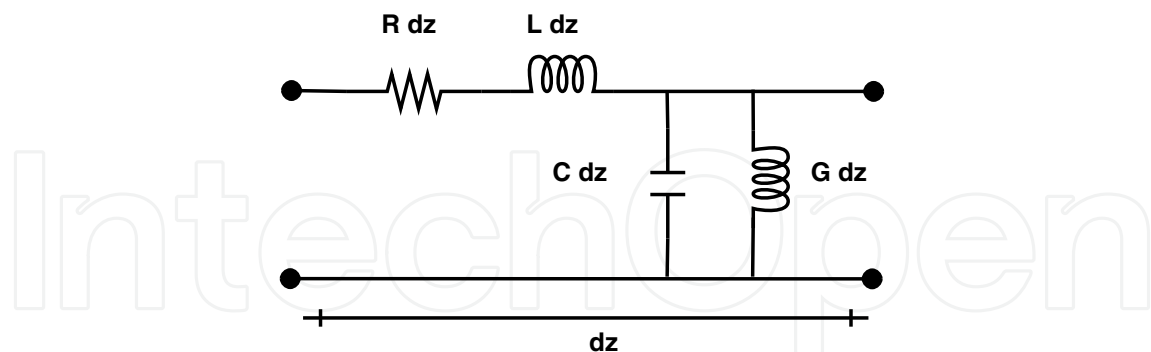

Fig. 2. Transmission line model per unit length dz .

The RLGC primary parameters completely determine a second set of electrical characteristics called secondary parameters. The secondary parameters consist of the propagation constant γ and the characteristic impedance Z_0 , which are given in Equations 1 and 2 respectively. Note that both are frequency dependent too.

$$\gamma = \alpha + j\beta = \sqrt{(G + j\omega C)(R + j\omega L)}, \quad (1)$$

$$Z_0 = \sqrt{\frac{R + j\omega L}{G + j\omega C}}, \quad (2)$$

The real part of the propagation constant γ is the attenuation constant α , which represents the loss in the transmission line. The imaginary part, β , represents phase constant. The phase constant relates the wavelength with the phase velocity for each frequency component of the signal (Yoho, 2001).

The secondary parameters are essential to model twisted-pair transmission lines through the two-port network - 2PN representation. In transmission line theory, a common way to represent a 2PN is to use the transmission matrix, also known as the ABCD matrix (Chen, 1998; Starr et al., 1999). It relates the voltage and current of the input port to the voltage and current of the output port. A cascade connection of two or more two-port networks can be found by simply multiplying the ABCD matrices of each individual two-port network; this aspect of the ABCD parameters allows easy evaluation of copper loops due to the chain-type nature of the topologies (Yoho, 2001). Figure 3 illustrates a two-port network representation, where V_1 and I_1 are the input voltage and input current and V_2 and I_2 are the output voltage and output current. The way they are related are shown in Equations 3 and 4,

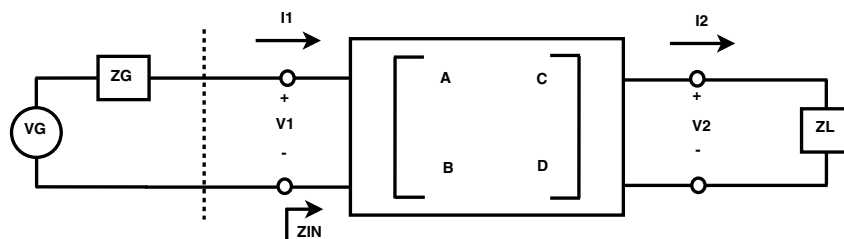

Fig. 3. Two-port network model.

$$V_1 = AV_2 + BI_2, \quad (3)$$

$$I_1 = CV_2 + DI_2, \quad (4)$$

Or as a matrix, as follows,

$$\begin{bmatrix} V_1 \\ I_1 \end{bmatrix} = \begin{bmatrix} A & B \\ C & D \end{bmatrix} \begin{bmatrix} V_2 \\ I_2 \end{bmatrix}, \quad (5)$$

The secondary line parameters γ and Z_0 are related to the ABCD parameters as follows, where l is the cable length,

$$\begin{bmatrix} A & B \\ C & D \end{bmatrix} = \begin{bmatrix} \cosh(\gamma l) & Z_0 \sinh(\gamma l) \\ \frac{1}{Z_0} \sinh(\gamma l) & \cosh(\gamma l) \end{bmatrix}, \quad (6)$$

Figure 3 also shows the source voltage V_G and source impedance Z_G (which are commonly the voltage and impedance of the data transmitter), the load impedance Z_L and the input impedance Z_{IN} , which can be found as follows,

$$Z_{IN} = \frac{V_1}{I_1} = \frac{AZ_L + B}{CZ_L + D}, \quad (7)$$

The direct transfer function of the copper twisted-pair is defined as the ratio of the voltage across the output port of the loop with the voltage placed on the input port. It can be very useful in order to indicate how attenuated a signal becomes after it passes through the channel. Equation 8 describes it when the input reference is the source voltage.

$$H = \frac{V_2}{V_G} = \frac{Z_L}{Z_G[CZ_L + D] + AZ_L + B}, \quad (8)$$

The measurements of direct transfer functions of short twisted-pair copper cables at unexplored DSL frequencies will be detailed in Section 4.

3.1 Crosstalk

Crosstalk is the leakage into one channel of signal power from another channel. For DSL, this means coupling between twisted-pairs in the same copper cable. The coupling mechanism is a consequence of the cable's construction. It increases both with cable length and frequency (Starr et al., 1999). Crosstalk is very random in nature and its transfer functions differ from wire-pair combination to wire-pair combination. These differences can be significant: up to tens of dB between the worst and best wire-pair combination (ETSI, 1997-02).

Crosstalk is one of the main impairments for DSL systems, it can reduce the full potential of broadband access over twisted-pair copper cables (Starr et al., 1999). It can present itself in two ways: far-end crosstalk (FEXT), which describes the coupled signals that originate from the end opposite of the affected twisted-pair, and near-end crosstalk (NEXT), which describes the coupled signals that originate from the same end as the affected twisted-pair (Oksman et al., 2010). Figures 4 and 5 illustrate FEXT and NEXT.

Crosstalk is an additional quantity that characterizes twisted-pair copper cables. The measurements of far-end crosstalk transfer functions of short copper cables at unexplored DSL frequencies will be detailed in Section 4.

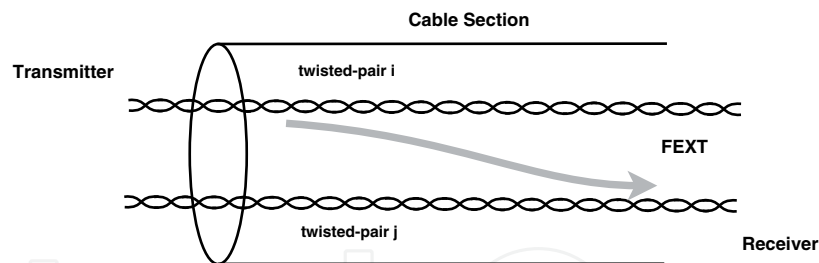

Fig. 4. Far-end crosstalk.

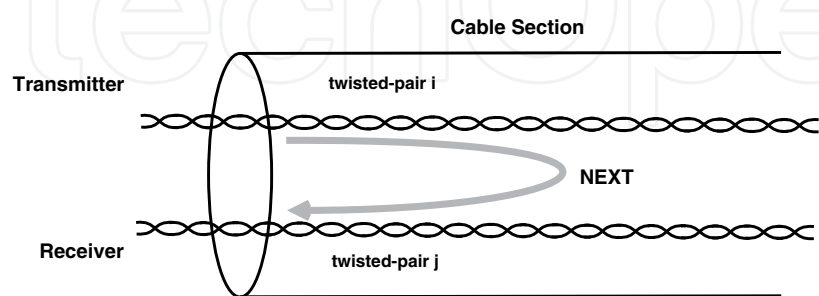

Fig. 5. Near-end crosstalk.

3.2 Cable models

In order to predict the transmissions behavior over twisted-pair copper cables in different topologies and scenarios (without real measurements data), DSL engineers have used the so-called cable models. These mathematical models can be very useful when applied in frequency domain-based computer simulations for performance evaluation of twisted-pair networks. The current cable models have proven to be especially useful to describe the behavior of twisted-pair copper cables over a range of frequencies from DC to tens of MHz with good precision (Chen, 1998; Starr et al., 1999). Two well-known cable models are described in this Subsection. It is important to notice that both models are not suitable for time domain evaluations due their non-causality.

3.2.1 British Telecom models - BT0 and BT1

The British Telecom (BT) models are focused in modeling twisted-pair copper cables by their primary parameters, RLGC (ETSI, 1997-02). Based on the primary parameters, their direct transfer functions can be easily found by the two-port network modeling approach using the ABCD matrix. The RLGC functions were fit to data produced from measurements performed by the BT laboratories. Two models are defined, BT0 and BT1 (ETSI, 1997-02). The RLGC functions of BT0 model are shown in Equations 9, 10, 11 and 12.

$$R(f) = \sqrt[4]{r_{oc}^4 + ac \cdot f^2}, \quad (9)$$

$$L(f) = \frac{l_0 + l_\infty \left(\frac{f}{f_m}\right)^b}{1 + \left(\frac{f}{f_m}\right)^b}, \quad (10)$$

$$G(f) = g_0 \cdot f^{g_e}, \quad (11)$$

$$C(f) = c_\infty + c_0 \cdot f^{-c_e}, \quad (12)$$

The values of the RLGC sub-parameters, e.g. r_{oc} , l_{∞} , ac , c_e , are defined according to the cable's gauge and material. ETSI and ANSI defined reference documents containing the correct values for each RLGC sub-parameter for different types of twisted-pair copper cables (ETSI, 1997-02).

BT1 model uses the same equations for LGC parameters. The only different function is related to R, which is given as follows,

$$R(f) = \frac{1}{\frac{1}{\sqrt[4]{r_{oc}^4 + ac \cdot f^2}} + \frac{1}{\sqrt[4]{r_{os}^4 + as \cdot f^2}}}, \quad (13)$$

3.2.2 Simplified twisted-pair cable model

The simplified twisted-pair cable model is described in (Chen, 1998) and (Starr et al., 1999). The mathematical approach of this model is focused on a function that takes into account the cable gauge, the cable length and its propagation constant for a given frequency range. For a perfectly terminated loop, that is, for a loop which is terminated with its characteristic impedance, the direct transfer function is given as follows, where d is the loop length and f is the frequency,

$$H(d, f) = e^{-dy(f)} = e^{-d\alpha(f)} e^{-jd\beta(f)}, \quad (14)$$

For frequencies higher than 250 kHz, the transfer function can be simplified as follows,

$$H(d, f) = e^{-d(k_1 \sqrt{f} + k_2 f)} e^{-jdk_3 f}, \quad (15)$$

where k_1 , k_2 and k_3 are fitting parameters related to the cable gauge. For frequencies up to 30 MHz, their values are fixed as shown in Table 1.

Gauge	$k_1 \times (10^{-3})$	$k_2 \times (10^{-8})$	$k_3 \times (10^{-5})$
22	3.0	0.35	4.865
24	3.8	-0.541	4.883
26	4.8	-1.709	4.907

Table 1. Parameters for the simplified twisted-pair cable model. This values are defined for frequencies up to 30 MHz.

It can be noticed that the simplified twisted-pair cable model does not takes into account the two-port network modeling approach using the ABCD matrix. It derives the direct transfer-function of a given twisted-pair directly by one equation.

This cable model will be used as basis to derive a fitted twisted-pair copper cable model for the fourth generation DSL systems, that will be described in Section 5.

4. Measurement techniques for the fourth generation DSL

Despite the usefulness of cable models, real measured data is the best way to characterize twisted-pair copper cables.

This section describes a measurement campaign, performed in order to evaluate the direct transfer functions and far-end crosstalk transfer functions of short twisted-pair copper cables.

It was used during the measurements 50m, 100m and 200m cables, including two different gauges, 0.4mm and 0.5mm (26 AWG and 24 AWG respectively). The results of these measurements can serve as a baseline for the observation of short copper cable's behavior when submitted to transmit high frequency signals, such as the fourth generation DSL proposes to implement. Recent works described that this frequency values can achieve 100 MHz, 200 MHz, even 300 MHz, depending on the cable quality (Magesacher et al., 2006; Odling et al., 2009; van den Brink, 2010).

The direct transfer functions and far-end crosstalk transfer functions were measured in frequency domain using a gain/phase-network analyzer. The measurement parameters were sent to the network analyzer via GPIB (General Purpose Interface Bus) interface, through a MATLAB script, and defined, among other things: the measured bandwidth, the number of sub-bands, the number of measurements on each twisted-pair and the calibration standards.

As current DSL systems apply FDD (Frequency Division Duplexing), which can mitigate the effects of near-end crosstalk, no NEXT was measured.

4.1 Equipments, setup and measurement procedures

The equipments used during the measurements were:

- Agilent Network Analyzer 4395A;
- 2 Baluns North Hills 0301BB (10kHz - 600MHz, 50 UNB, 100 BAL);
- Agilent 87512A (Signal Splitter - measurement B/R);
- 100 Ω impedance matching resistors;
- Trim trio connectors;
- 50m 0.4mm 16 pair copper cable;
- 100m 0.5mm 24 pair copper cable;
- 200m 0.5mm 24 pair copper cable;
- 200m 0.4mm 16 pair copper cable;

The used cables were chosen randomly in a set of short copper cables. Trim trio connectors were then soldered in the beginning and in the end of each individual twisted-pair inside this cables. During each measurement, the selected twisted-pair was connected to the network analyzer through the baluns, that was responsible for the balanced and unbalanced signal conversion ¹. The baluns also had the function to convert the system impedance from 50 Ω of the network analyzer to 100 Ω of the copper loop (Agilent, 2000). Figure 6 illustrates the measurements experimental setup, through the connection of the used equipments.

It is important to describe that the temperature conditions were kept constant during the measurements. Figure 7 illustrates the real equipments used during the experiments such as the network analyzer, the twisted-pair copper cables, the baluns and the trim trio connectors.

The measurements management was done by a MATLAB script that was coded to operate this way:

- Calibrates the network analyzer;

¹ The balanced transmission method is used by the copper loop, however almost all measurement instruments have unbalanced input and output ports

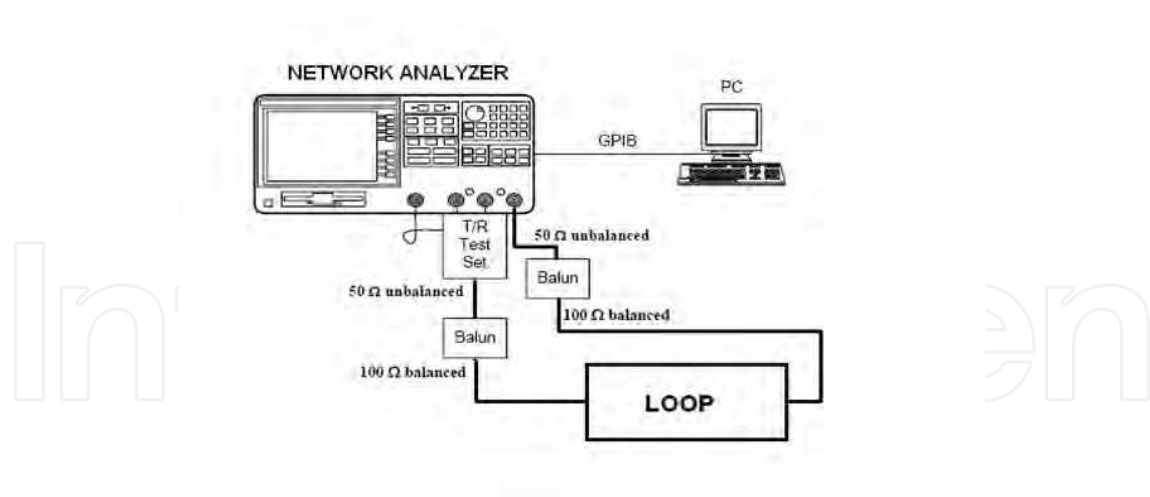

Fig. 6. Experimental setup used during the measurements campaign.

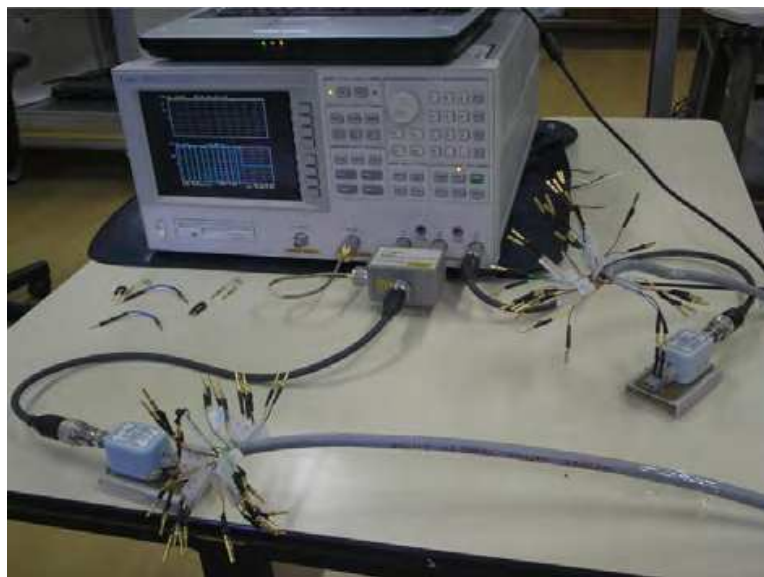

Fig. 7. Overview of the used equipments: network analyzer, twisted-pair cables, baluns and trim trio connectors.

- Sets the defined measurements parameters, such as the measured bandwidth and the number of measurements on each twisted-pair;
- Measures the twisted-pair;
- Checks if there was any outliers by using the Dixon's test;
- Saves the results in ASCII files;

It was defined that three measurements on each pair, without outliers, ensured the results reliability. The main measurements parameters were:

- Start frequency: 0 Hz;
- Stop frequency: 100 MHz;
- Number of sub-bands: 6;
- Number of measurements on each twisted-pair: 3;

- Calibration standards: open, short, through;
- Display of channel 1: Magnitude;
- Display of channel 2: Phase;

The measurements were performed only for positive frequencies, from start frequency to stop frequency, in low-pass mode. It was assumed a uniform sampling of the frequency axis, which means that neighboring points were separated by Δf Hz, which is called frequency resolution. For the measured 50m 0.4mm and 200m 0.4mm cables, Δf was set to 43.125 kHz, while for the measured 100m 0.5mm and 200m 0.5mm, Δf was set to 4.3125 kHz.

4.2 Measurements results

As described in Subsection 4.1, three different lengths of short copper cables were measured. The used 50m cable was a 16 pair 0.4 mm (26 AWG). This cable measurements resulted in 256 channel transfer functions: 16 direct transfer functions and 240 far-end crosstalk (FEXT) transfer functions. The used 100m cable was a 24 pair 0.5mm (24 AWG). This cable measurements resulted in 576 channel transfer functions: 24 direct transfer functions and 552 FEXT transfer functions. For the 200m length, two different gauges were used. The first cable was a 16 pair 0.4mm. This cable measurements resulted in 256 channel transfer functions: 16 direct transfer functions and 240 FEXT transfer functions. The second cable was a 24 pair 0.5 mm. This cable measurements resulted in 576 channel transfer functions: 24 direct transfer functions and 552 FEXT transfer functions. The measured bandwidth for all fours cables was 100 MHz.

Figures 8, 9, 10 and 11 show some recorded data from the 50m, 100m and 200m copper cables measurements in terms of direct transfer functions and FEXT transfer functions. It can be observed the direct channel attenuation increase due to the copper cable length increase. For example, at 100 MHz using the measured 50m 0.4mm cable the magnitude is near -15 dB while at the same 100 MHz using the measured 200m 0.5mm cable the magnitude is near -40 dB.

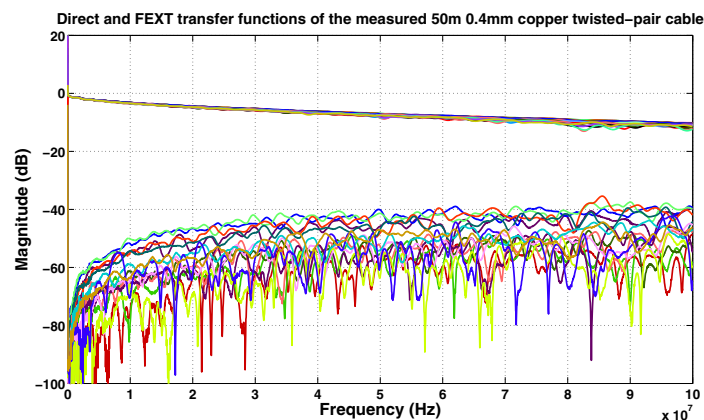

Fig. 8. Direct transfer functions (upper curves) and FEXT transfer functions (lower curves) of the measured 50m 0.4mm copper cable.

5. Modeling techniques for the fourth generation DSL

The current cable models have proven to be especially useful to describe the behavior of twisted-pair copper cables over a range of frequencies from DC to tens of MHz (e.g, 30 MHz), that is, the frequency range of the current DSL standards (Chen, 1998; Golden et al., 2006).

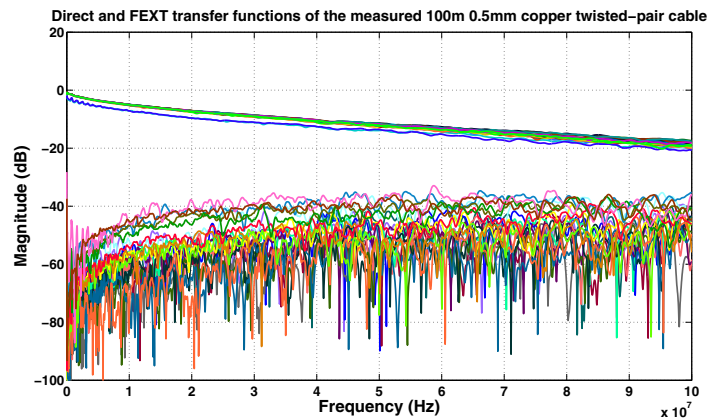

Fig. 9. Direct transfer functions (upper curves) and FEXT transfer functions (lower curves) of the measured 100m 0.5mm copper cable.

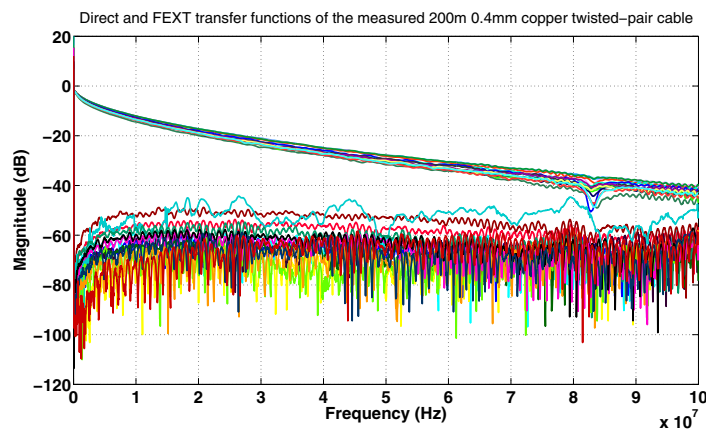

Fig. 10. Direct transfer functions (upper curves) and FEXT transfer functions (lower curves) of the measured 200m 0.4mm copper cable.

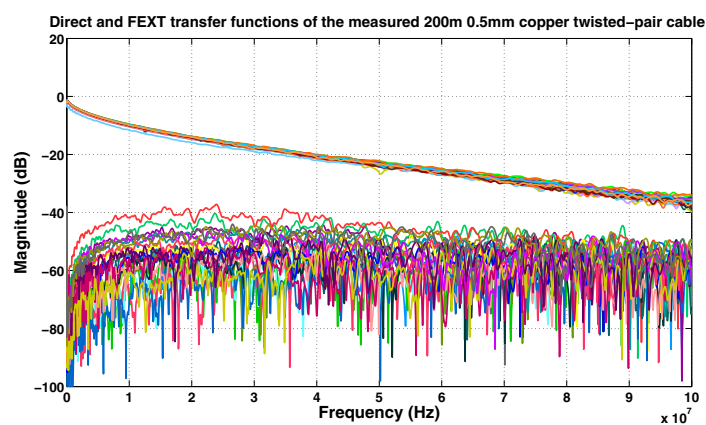

Fig. 11. Direct transfer functions (upper curves) and FEXT transfer functions (lower curves) of the measured 200m 0.5mm copper cable.

In order to help researchers and students all over the world to do their own simulations for performance evaluation of the fourth generation DSL systems, this Section describes a modeling technique for fitting the simplified twisted-pair cable model, described in

Sub-subsection 3.2.2. The objective is to make it suitable to describes the direct transfer functions behavior of short twisted-pair copper cables up to 100 MHz.

The fitting process is performed for one cable gauge (0.4mm), but the same procedure can be done to derive fitted models for other cable gauges. It was focused in find the best values for the three parameters of the simplified twisted-pair cable model, k_1 , k_2 and k_3 , in order to make the generated transfer functions as near as possible to the obtained by the average of the measurements described in Subsection 4.2.

The fitting procedure was done this way:

- It was chosen the 0.4mm gauge (26 AWG);
- The RLGC parameters were calculated using BT0 equations, described in Equations 9, 10, 11, 12. The values of each RLGC sub-parameter were taken from (ITU-T, 1999b). It is important to notice that these values are well-defined for frequencies up to 30 MHz;
- Based on the RLGC parameters, it was calculated the propagation constant γ , described in Equation 1;
- Based on the propagation constant γ , it was calculated the attenuation constant α ;
- k_2 was found by the resolution of the system shown in Equation 16;
- k_1 was found by brute force;
- k_1 and k_2 was set in order to minimize the mean square error between them and α , as shown in Equation 17. k_3 was found by observing β ;

$$k_1 \sum_{i=1}^n f_i + k_2 \sum_{i=1}^n f_i^{1.5} = \sum_{i=1}^n f_i^{0.5} \alpha_i(f_i) \quad (16)$$

$$k_1 \sum_{i=1}^n f_i^{1.5} + k_2 \sum_{i=1}^n f_i^2 = \sum_{i=1}^n f_i \alpha_i(f_i),$$

$$\epsilon_i^2 = (k_1 \sqrt{f_i} + k_2 f_i - \alpha_i(f_i))^2, \quad (17)$$

The obtained parameters for the 0.4mm gauge cable were:

- $k_1=3.9e^{-3}$;
- $k_2=0.16750^{-8}$;
- $k_3=3.0e^{-5}$;

Figures 12 and 13 illustrate the comparison between the direct transfer functions obtained by the fitted simplified twisted-pair cable model (proposed by this work), the average of the real cable measurements (performed by this work), the original simplified twisted-pair cable model (described in (Chen, 1998) and (Starr et al., 1999)) and BT1 model (described in (ETSI, 1997-02)) for 50m 0.4mm and 200m 0.4mm copper cables respectively.

It is clear the the direct transfer functions obtained by the fitted simplified model proposed by this work are closer to the obtained by the real measurements. It indicates that the fitted model can be suitable for frequency domain-based simulations in order to evaluate the performance of the fourth generation DSL systems. It is important to notice that good behavior in frequency

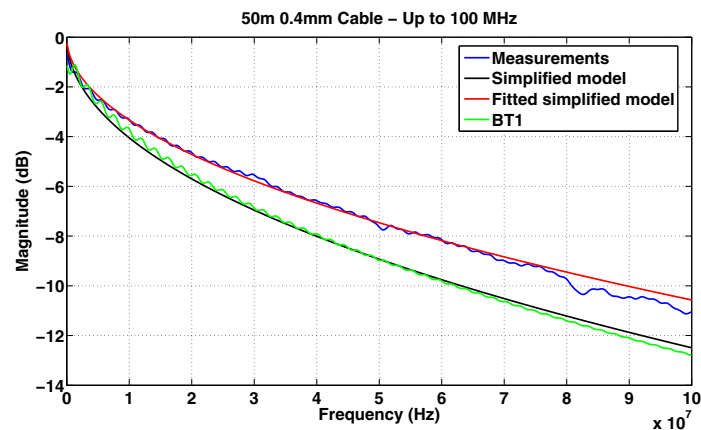

Fig. 12. Direct transfer functions obtained by the fitted simplified model, the average of measurements, the original simplified model and BT1 model. 50m 0.4mm cable.

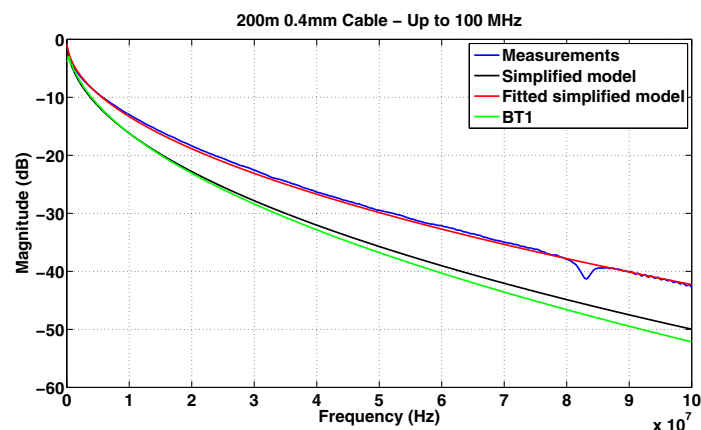

Fig. 13. Direct transfer functions obtained by the fitted simplified model, the average of measurements, the original simplified model and BT1 model. 200m 0.4mm cable.

domain does not ensure good behavior in time domain, so it can be said that the proposed model is not suitable for time domain simulations.

Figures 14 and 15 illustrate the mean square error between the proposed fitted simplified twisted-pair cable model, the original simplified twisted-pair cable model and BT1 model when compared to the real measurements.

6. Frequency domain simulations for evaluation of the fourth generation DSL

The research on the fourth generation DSL systems is currently based on computer simulations, highlighting frequency domain (or PSD-based) simulations. An example of key results that can be achieved by frequency domain simulations we can cite the achievable data rates obtained by these systems. Initial studies showed that the bandwidth limit beyond where there are no significant data rate increases is 100 MHz (Magesacher et al., 2006), however, recent ITU contributions consider that the transmission bandwidth can be as high as 300 MHz depending on the used cable quality (van den Brink, 2010). This section describes some frequency domain simulations for performance evaluation of the next generation DSL systems. The used channel data was based on the results obtained by the short copper cable

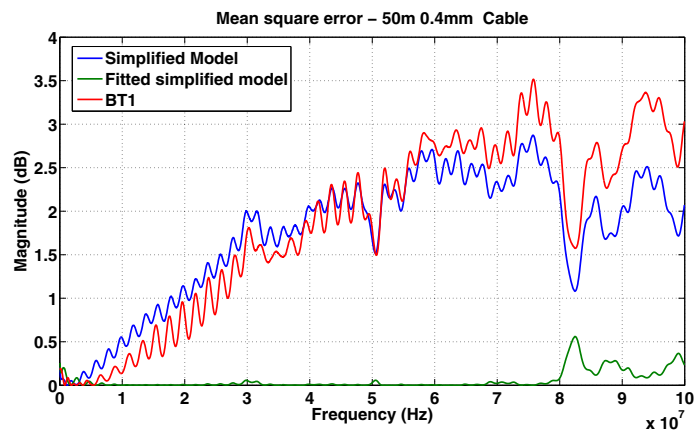

Fig. 14. Mean square error between the proposed fitted simplified model, the original simplified model and BT1 model when compared to the real measurements. 50m 0.4mm cable.

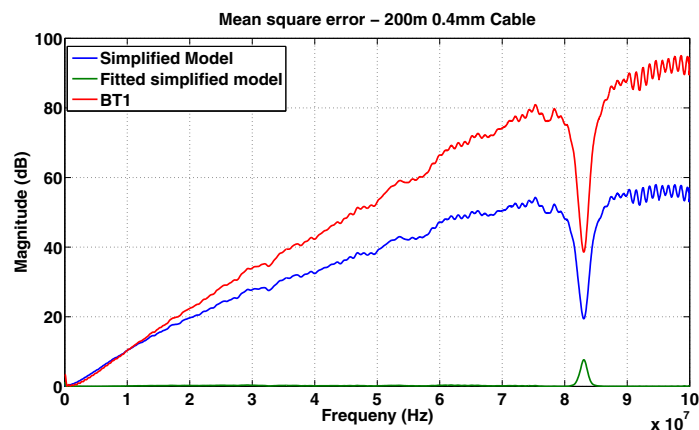

Fig. 15. Mean square error between the proposed fitted simplified model, the original simplified model and BT1 model when compared to the real measurements. 200m 0.4mm cable.

measurements described in Section 4 and cable reference models, including the fitted model proposed in Section 5.

Two approaches for frequency domain simulations are described. The first one focus the maximum data rates achievable by a hypothetical DMT-based fourth generation DSL system. The second one focus the maximum number of bits-per-tone that can be used by theses systems without loss of performance.

6.1 Achievable data rates of fourth generation DSL systems

For the evaluation of the achievable data rates of fourth generation DSL systems, two scenarios are defined. The first one observes an ideal transmission case, that is, without crosstalk impairment. It can be possible if all lines inside the copper cable are connected to a Vectored fourth generation DSL access node. In fact, the next generation DSL systems may offer support for vectoring in order to enjoy the full benefits of high frequency transmissions (Odling et al., 2009; Oksman et al., 2010). The second one observes the achievable data rates

degradation resulting when one FEXT disturber is affecting a given user. This case the NEXT effects were mitigated assuming a FDD transmission.

A key point in both simulations is to define the transmission PSD (Power Spectrum Density) masks. For now, there are no definitions done by ITU on these recommendations. So, the first transmission PDS mask used here is defined according to the one proposed by (Magesacher et al., 2006). This mask is derived from the ingress and egress limits described in the CISPR 22 norm. It follows the standard VDSL2 up to 30 MHz, which is -60 dBm/Hz. For frequencies above 30 MHz, the PSD mask decays linearly from -60 dBm/Hz to -80 dBm/Hz at 100 MHz. Figure 16 shows this PSD mask, divided in upstream and downstream bands. Note that the spectrum was divided in a symmetrical way between upstream and downstream transmission, but with higher priority for downstream, as this one uses, for most of its tones, lower (less attenuated) frequencies. Furthermore, four other PSD masks are defined. The objective is to compare the impact of each one to the obtained data rates. Their power limits followed this assumptions:

- -60 dBm/Hz up to 30 MHz, then -80 dBm/Hz up to 100 MHz, flat shape;
- -60 dBm/Hz up to 30 MHz, then -76 dBm/Hz up to 100 MHz, flat shape;
- -60 dBm/Hz up to 30 MHz, then -72 dBm/Hz up to 100 MHz, flat shape;
- -60 dBm/Hz up to 30 MHz, then -68 dBm/Hz up to 100 MHz, flat shape;

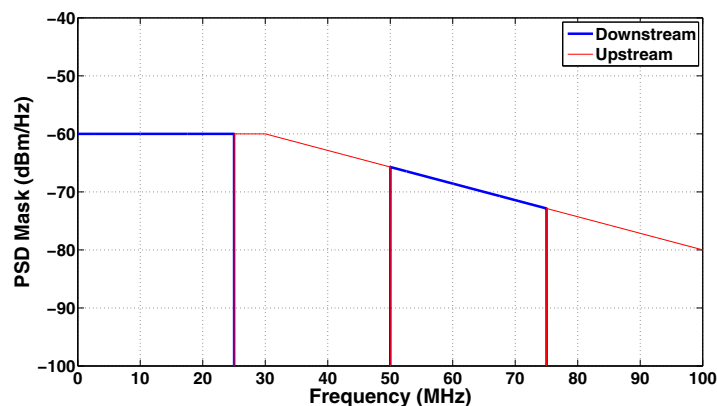

Fig. 16. One of the PSD masks used by the 4th generation DSL systems adopted in this work.

The bits allocation per tone k and for user n is expressed as follows (Starr et al., 1999)

$$b_n^k = \log_2 \left(1 + \frac{1}{\Gamma \gamma_n} \frac{|h_{n,n}^k|^2 p_n^k}{\sum_{n \neq m} |h_{n,m}^k|^2 p_m^k + \sigma_n^k} \right), \quad (18)$$

where

- $|h_{n,n}^k|^2$ is the the square-magnitude of the direct transfer function gain for user n at tone k ;
- $|h_{n,m}^k|^2$ denotes the square-magnitude of the far-end crosstalk transfer function from transmitter m to receiver n at tone k ;
- p_m^k denotes the power transmitted by user m at tone k ;
- σ_n^k represents the background noise power on tone k at receiver n ;

- Γ is the signal-to-noise (SNR) ratio gap, which is a function of the desired bit error rate;
- γ_n is the noise margin of user n ;

The total data rate R_n of each user n is calculated as

$$R_n = f_s \sum_{k=1}^K b_n^k \quad (19)$$

where f_s is the DMT symbol rate (Starr et al., 1999).

The main transmission parameters used during the simulations of the two scenarios (with and without crosstalk) are described as follow:

- Background Noise: AWGN, -140 dBm/Hz;
- Tone spacing Δf : 25 kHz;
- Symbol rate: 21.562 kHz;
- DS max power: 14.5 dBm;
- US max power: 12.2 dBm;
- Target SNR margin: 5 dB;
- SNR Gap for uncoded QAM: 9.8 dB;
- Maximum number of bits per tone: 15 ;

As an initial approach, the first simulated scenario (which assumed no crosstalk impairment), uses as channel data the ANSI TP1 cable model extended up to 100 MHz. This cable model uses BT equations for calculates RLGC parameters. The values of each RLGC sub-parameter are defined in (ITU-T, 1999b).

The obtained results, using the five different PSD masks previously defined, are illustrated in Figure 17

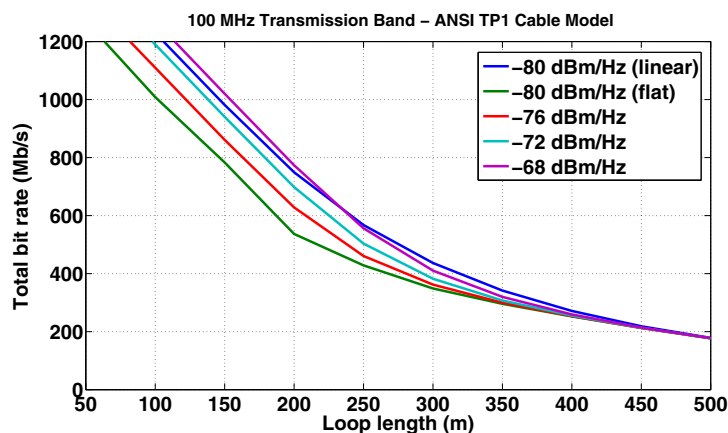

Fig. 17. Obtained bit rates up to 100 MHz using the extended ANSI TP1 as channel data. No crosstalk is taken into account.

It can be observed that, even using any one of the five PSD masks, the maximum achievable data rates are bigger than 1 Gb/s when the copper loop is shorter than 150 m. Using a 300 m cable, the data rates become near 400 Mb/s, while using a 500 m cable it is reduced to near 200 Mb/s.

In order to compare the mismatch between the results of frequency domain-based simulation using real measured data and current cable models, another simulation of the first scenario is performed. This case the channel data are the ones obtained by the short copper cable measurements described in Section 4. Figure 18 illustrates the mismatch for all the defined PSD mask limits.

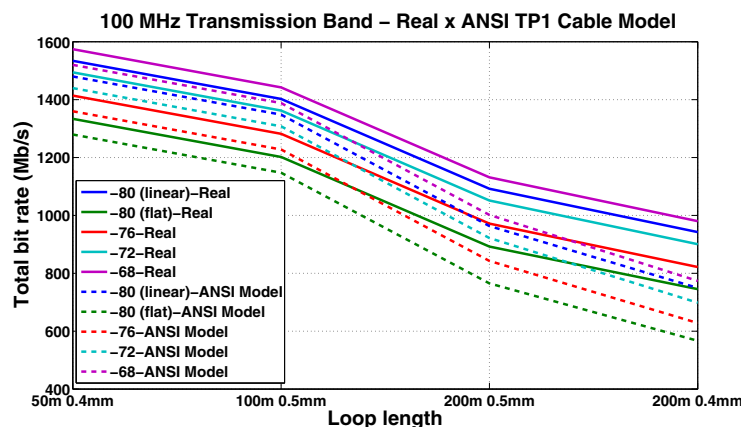

Fig. 18. Mismatch on the obtained bit rates using real channel measured data versus extended cable model.

It is clear the mismatch on the results. The difference can be as high as 200 Mb/s for some PSD masks using the 200m 0.4mm cable. So, in order to prove the quality of the fitted model performed in Section 5, another simulation is shown, this case using the fitted model of the 50m and 200m 0.4mm cables as channel data. Figure 19 illustrates the results.

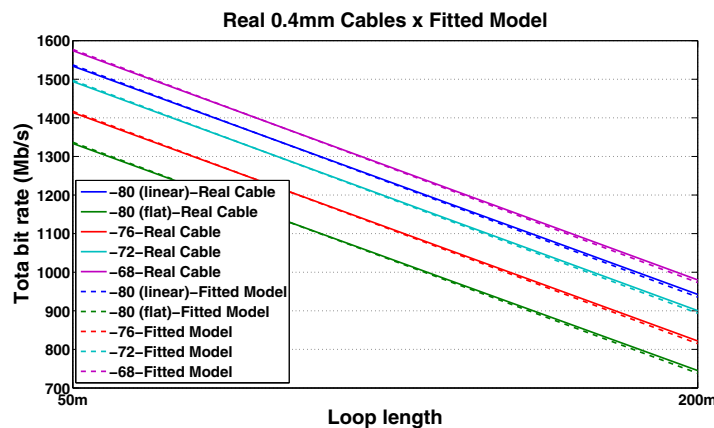

Fig. 19. Obtained bit rates using as channel data the fitted model and the average of the copper cable measurements. 50m and 200m 0.4mm cables.

The results shown in Figure 19 present good match, indicating the fitted model is well-characterized for frequency domain-based simulations in order to evaluate the performance of the fourth generation DSL systems.

For the frequency range being considered for use by the fourth generation DSL systems (100, 200, even 300 MHz), crosstalk can be an even worse impairment than it is for current DSL deployments. Hence, crosstalk mitigation techniques are highly recommended for these systems, allowing them to achieve the best possible performance (Odling et al., 2009; van den Brink, 2010). In order to evaluate the rates degradation of the fourth generation DSL

systems transmissions due to uncanceled crosstalk effects, a second frequency domain-based simulation scenario for evaluation of achievable data rates is defined. This time two users share the same binder and are affected by uncanceled far-end crosstalk. Figure 20 illustrates it.

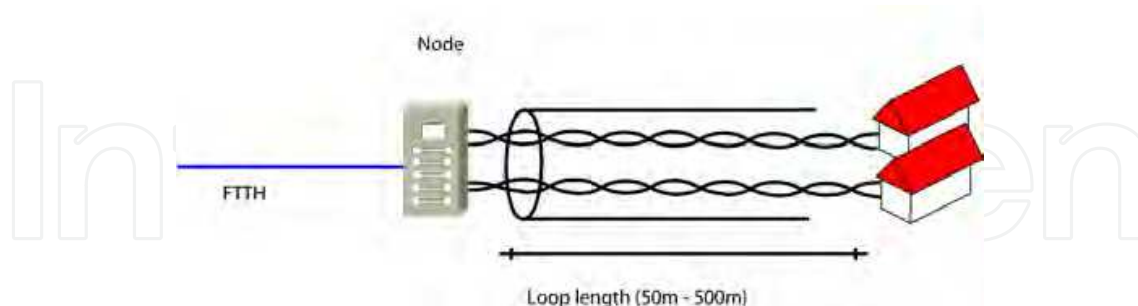

Fig. 20. Second scenario for evaluation of the achievable data rates of 4th generation DSL systems. Crosstalk is taken into account.

The adopted five PSD mask limits and transmission parameters are the same previously described. Figure 21 illustrates the results.

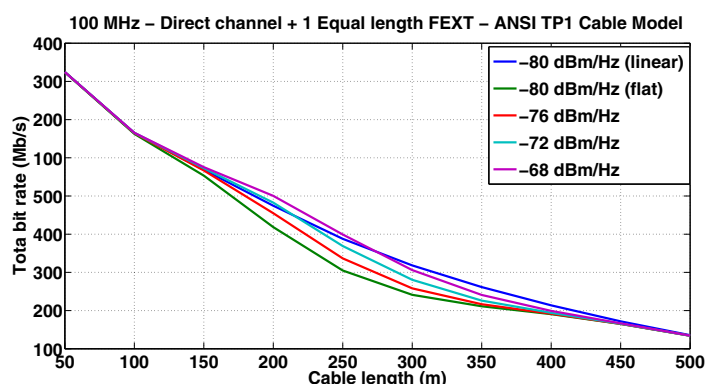

Fig. 21. Obtained bit rates up to 100 MHz using the extended ANSI TP1 as channel data. Uncanceled far-end crosstalk is taken into account.

It is clear that the data rates degrade significantly if no attempt is done to control crosstalk effects. It can be illustrated by the achieved data rate of the -80 dBm/Hz (linear) PSD mask. Using a 200m cable, it was near 800 Mb/s when no crosstalk was taken account, as shown in Figure 17, while it was near 500 Mb/s when crosstalk was considered, a decrease of almost 300 Mb/s.

6.2 Maximum number of bits/tone that should be used by fourth generation DSL systems

After evaluate the possible data rates obtained by a hypothetical DMT-based fourth generation DSL system, a new set of frequency domain simulations are described here. This time it is observed the maximum number of bits per DMT tone, or constellation size, that should be used by these systems, up to 100MHz. The maximum number of bits/tone is related to the constellation size: $\text{constellation size} = 2^{\text{bits/tone}}$. An optimal value of number of bits/tone is a key element to limit complexity of these systems.

The first scenario is defined as a direct loop with no crosstalk effect. Again, as an initial approach, it is used a cable model extrapolated up to 100 MHz. The used cable model is the

ETSI ADSL PEO4 (26 AWG), which uses BT equations for calculates RLGC parameters. The values of each RLGC sub-parameter are defined in (ITU-T, 1999b). During this evaluation, only the PSD mask limit illustrated in Figure 16 is used. Figure 22 illustrates the obtained data rates for each value defined as maximum number of bits/tone.

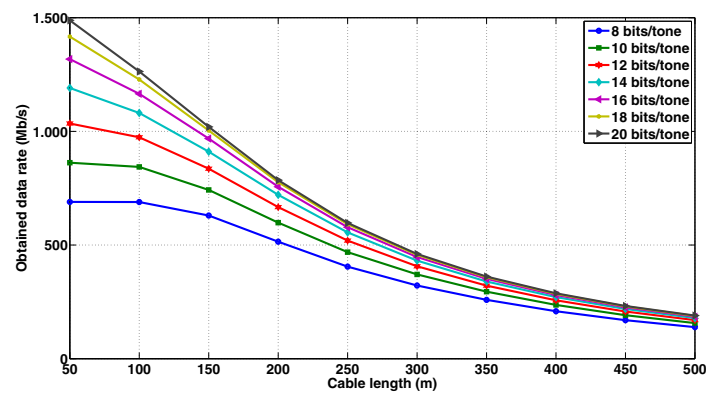

Fig. 22. Obtained data rates using different values of maximum number bits/tone. No crosstalk is taken into account. 0.4mm (26 AWG) cable model.

It can be concluded that an optimal value to be used as maximum number of bits/tone can be found between 12 and 14 bits. Below 12 bits the performance is strongly reduced and above 14 bits there is no much difference in terms of obtained data rates, especially for loop lengths longer than 200m, this way, the cost benefit (computational complexity versus improvements) may not be favorable.

Knowing that current cable models are not well characterized for high frequency DSL simulations, a new round of simulation to observe the achievable data rates using different maximum number of bits/tone is shown. This time the channel is based on the developed fitted model, described in Section 5.

Figure 23 illustrates the obtained data rates for each value defined as maximum number of bits/tone.

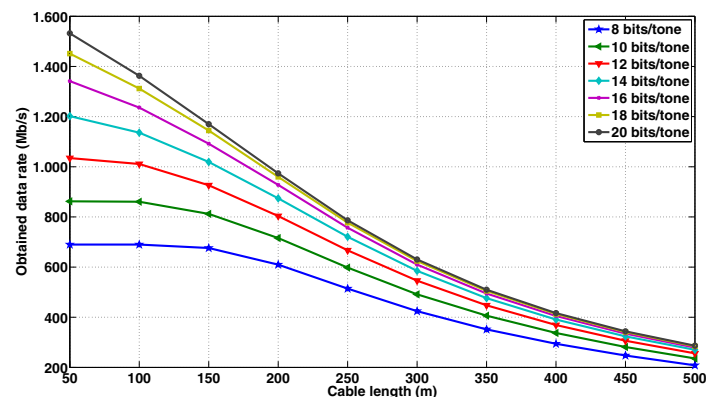

Fig. 23. Obtained data rates using different values of maximum number bits/tone. No crosstalk is taken into account. 0.4mm fitted cable model.

Figure 24 illustrates the expected mismatch between the results using ETSI PE04 cable model and the fitted 0.4mm cable model proposed by this work.

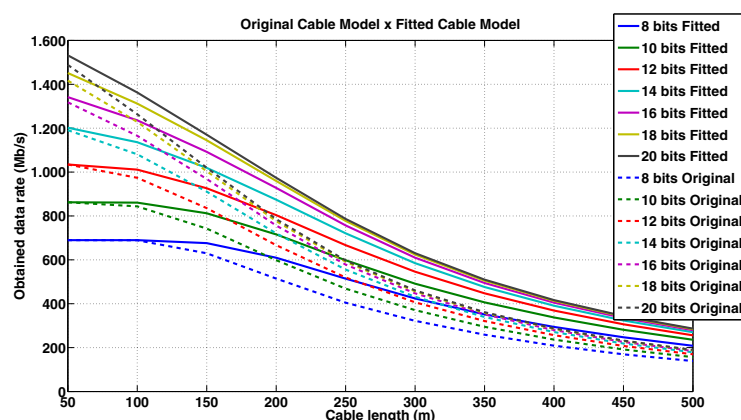

Fig. 24. Difference between the obtained results using ETSI PE04 cable model and the fitted 0.4mm cable model.

Finishing the frequency domain simulations described here, it is shown the impact of uncanceled far-end crosstalk in the achievable data rates of the fourth generation DSL systems even if they use different maximum number of bits/ tone. The scenario overview is like the one illustrated in Figure 20. It was used the ESTI PE04 cable model. It was done because no crosstalk models were fitted. Figure 25 illustrates the obtained results, where it becomes clear that the data rate degrades significantly if no attempt is done to control crosstalk effects. The results reinforces that crosstalk mitigation techniques are highly recommended for the fourth generation DSL systems, allowing them to achieve the best possible performance.

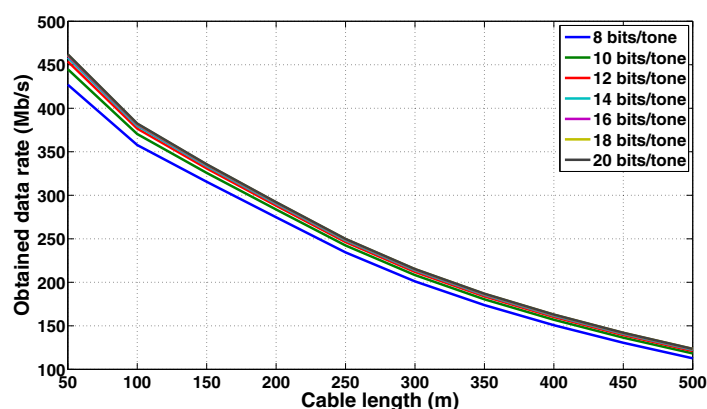

Fig. 25. Performance of 4th generation DSL systems using different values of maximum number bites/tone impaired by uncanceled FEXT.

7. Conclusion

During the last years, broadband technologies over copper increased their end-user bit rates due to a step-by-step evolution.

The fourth generation DSL systems, wish to improve the provided services achieving data rates near 1 Gb/s. As the direct channel attenuation is higher if the copper loop is long, the use of short cables will be inevitable to ensure improved rates. The copper cable reduction process will allow the use of unexplored transmission frequencies, much higher than the current 30

MHz. Unfortunately, the current cable reference models are not able to predict the behavior of short twisted-pair copper cables at unexplored DSL frequencies.

This work described measurement and modeling techniques for characterize short twisted-pair copper cables at these new transmission environments. The measurements techniques were exemplified by a measurement campaign that evaluated the direct transfer functions and far-end crosstalk transfer functions of 50m, 100m and 200m copper cables. It was described the used equipments, the measurements parameters and measurements procedures. The measurements results of direct transfer functions showed how attenuated the direct channel of short cables can be. These informations are very important for the determination of channel capacities, which can show the maximum bit rates supported by these transmission channels. The far-end crosstalk measurements results showed how impaired the transmissions over short copper cables can be if no technique to avoid this interference is implemented.

The modeling techniques were exemplified by a fitting process in order to adjust the simplified twisted-pair cable model to ensure a well characterized response up to 100 MHz. The direct transfer functions generated by this fitted model proved to be much more similar to the ones obtained by the measurements of real copper cables. It is important to notice that although it presents good behavior in frequency domain, the proposed model is not suitable for time domain-based simulations.

This chapter also presented some frequency domain simulations in order to evaluate the potential of the fourth generation DSL systems. It was verified that the achievable data rates up to 100 MHz can be as high as 1 Gb/s. Moreover it was verified that an optimal value to be used as maximum number of bits/ tone is near 12 bits. As a last contribution this work showed the effects of uncanceled crosstalk in the reduction of the performance of these systems.

8. Acknowledgments

This work was supported by the Innovation Center, Ericsson Telecomunicações S.A., Brazil, and CNPq

9. References

- Acatauassu, D., Muller, F. & Klautau, A. (2009). Capacity of MIMO DSL systems using 100 MHz measured channel data, *International Conference on Telecommunications, 2009. ICT '09.*, pp. 266–269.
- Agilent (2000). ADSL copper loop measurements - Agilent Technologies Product Note.
- Cendrillon, R. & Moonen, M. (2005). Iterative spectrum balancing for digital subscriber lines, *2005 IEEE International Conference on Communications, 2005. ICC 2005.*, Vol. 3, pp. 1937 – 1941 Vol. 3.
- Chen, W. Y. (1998). *DSL : Simulation Techniques and Standards Development for Digital Subscriber Lines*, Macmillan Technology Series, Macmillan Technical Publishing, Indianapolis, IN.
- ETSI (1997-02). STD. ETSI STC TM6 - Cable Reference Models for Simulating Metallic Access Networks.
- Golden, P., Dedieu, H. & Jacobsen, K. (2006). *Fundamentals of DSL Technology*, Auerbach Publications, Taylor & Francis Group.

- ITU-T (1991). Integrated services digital network (ISDN)-Basic access interface for use on metallic loops for application on the network side of the NT (layer 1 specification).
- ITU-T (1999a). Asymmetric Digital Subscriber Line (ADSL) transceivers.
- ITU-T (1999b). ITU-T G996.1 - Test Procedures for Digital Subscriber Line (DSL) Transceivers.
- ITU-T (2003). Asymmetric Digital Subscriber Line Transceivers 2 (ADSL2).
- ITU-T (2005a). Asymmetric Digital Subscriber Line (ADSL) transceivers - Extended bandwidth ADSL2 (ADSL2+).
- ITU-T (2005b). Very high speed digital subscriber line transceivers (VDSL).
- ITU-T (2006). Very high speed digital subscriber line transceivers 2 (VDSL2), *ITU-T Recommendation G.993.2*.
- Magesacher, T., Rius i Riu, J., Ödling, P., Börjesson, P., Tilocca, M. & Valentini, M. (2006). Limits of ultra-wideband communication over copper, *International Conference on Communication Technology, 2006. ICCT '06.*, pp. 1 –4.
- Moraes, R. B., Dortschy, B., Klautau, A. & Riu, J. R. i. (2010). Semiblind spectrum balancing for DSL, *IEEE Transactions on Signal Processing* 58(7): 3717–3727.
- Ödling, P., Magesacher, T., Host, S., Borjesson, P., Berg, M. & Areizaga, E. (2009). The fourth generation broadband concept, *IEEE Communications Magazine* 47(1): 62 –69.
- Oksman, V., Schenk, H., Clausen, A., Cioffi, J., Mohseni, M., Ginis, G., Nuzman, C., Maes, J., Peeters, M., Fisher, K. & Eriksson, P.-E. (2010). The ITU-T's new G.vector standard proliferates 100 MB/s DSL, *IEEE Communications Magazine* 48(10): 140 –148.
- Song, K. B., Chung, S. T., Ginis, G. & Cioffi, J. (2002). Dynamic spectrum management for next-generation DSL systems, *IEEE Communications Magazine* 40(10): 101 – 109.
- Starr, T., Cioffi, J. M. & Silverman, P. J. (1999). *Understanding Digital Subscriber Line Technology*, Prentice-Hall.
- van den Brink, R. F. (2010). Enabling 4GBB via hybrid-FttH, the missing link in FttH scenarios, BBF 2010.1395.
- Vergara, A., Moral, A. & Peñalanda, J. (2010). Costa: A model to analyze next generation broadband access platform competition, *14th International Telecommunications Network Strategy and Planning Symposium (NETWORKS), 2010*, pp. 1 –6.
- Yoho, J. J. (2001). *Physically-Based Realizable Modeling and Network Synthesis of Subscriber Loops Utilized in DSL Technology*, PhD thesis, Virginia Polytechnic Institute and State University.

IntechOpen

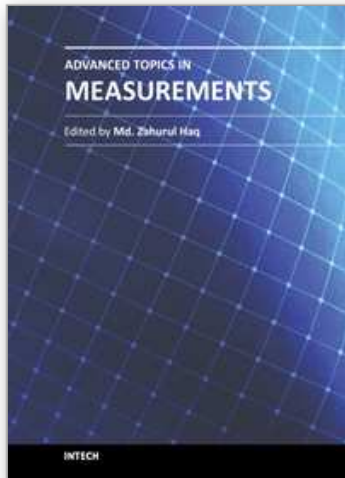

Advanced Topics in Measurements

Edited by Prof. Zahurul Haq

ISBN 978-953-51-0128-4

Hard cover, 400 pages

Publisher InTech

Published online 07, March, 2012

Published in print edition March, 2012

Measurement is a multidisciplinary experimental science. Measurement systems synergistically blend science, engineering and statistical methods to provide fundamental data for research, design and development, control of processes and operations, and facilitate safe and economic performance of systems. In recent years, measuring techniques have expanded rapidly and gained maturity, through extensive research activities and hardware advancements. With individual chapters authored by eminent professionals in their respective topics, *Advanced Topics in Measurements* attempts to provide a comprehensive presentation and in-depth guidance on some of the key applied and advanced topics in measurements for scientists, engineers and educators.

How to reference

In order to correctly reference this scholarly work, feel free to copy and paste the following:

Diogo Acatauassu, Igor Almeida, Francisco Muller, Aldebaro Klautau, Chenguang Lu, Klas Ericson and Boris Dortschy (2012). Measurement and Modeling Techniques for the Fourth Generation Broadband Over Copper, *Advanced Topics in Measurements*, Prof. Zahurul Haq (Ed.), ISBN: 978-953-51-0128-4, InTech, Available from: <http://www.intechopen.com/books/advanced-topics-in-measurements/measurement-and-modeling-techniques-for-the-fourth-generation-broadband-over-copper>

INTECH
open science | open minds

InTech Europe

University Campus STeP Ri
Slavka Krautzeka 83/A
51000 Rijeka, Croatia
Phone: +385 (51) 770 447
Fax: +385 (51) 686 166
www.intechopen.com

InTech China

Unit 405, Office Block, Hotel Equatorial Shanghai
No.65, Yan An Road (West), Shanghai, 200040, China
中国上海市延安西路65号上海国际贵都大饭店办公楼405单元
Phone: +86-21-62489820
Fax: +86-21-62489821

© 2012 The Author(s). Licensee IntechOpen. This is an open access article distributed under the terms of the [Creative Commons Attribution 3.0 License](#), which permits unrestricted use, distribution, and reproduction in any medium, provided the original work is properly cited.

IntechOpen

IntechOpen