

We are IntechOpen, the world's leading publisher of Open Access books Built by scientists, for scientists

4,800

Open access books available

122,000

International authors and editors

135M

Downloads

Our authors are among the

154

Countries delivered to

TOP 1%

most cited scientists

12.2%

Contributors from top 500 universities

**WEB OF SCIENCE™**Selection of our books indexed in the Book Citation Index
in Web of Science™ Core Collection (BKCI)

Interested in publishing with us?
Contact book.department@intechopen.com

Numbers displayed above are based on latest data collected.
For more information visit www.intechopen.com



Integrating Reverse Engineering and Design for Manufacturing and Assembly in Products Redesigns: Results of Two Action Research Studies in Brazil

Carlos Henrique Pereira Mello, Carlos Eduardo Sanches da Silva,
José Hamilton Chaves Gorgulho Junior, Fabrício Oliveira de Toledo,
Filipe Natividade Guedes, Dóris Akemi Akagi
and Amanda Fernandes Xavier
*Federal University of Itajubá (UNIFEI),
Center of Optimization of Manufacturing and Technology Innovation (NOMATI)
Brazil*

1. Introduction

Due to increased market pressure, product specifications are required to be developed and updated on a rapid and continual basis. Companies know that to compete in the market they must learn to analyze and address the actual arithmetic increase, but to do so at an exponential pace.

Improving a product involves offering new features, new technology and attractive ways to enhance the quality for market launch. Companies are employing and reaping the benefits of market analysis techniques to assist in predicting what the market is postulating, now and in the future.

Customers anxiously await the release of new products, frequently and expeditiously. Many of these customers expect and anticipate that their favorite brand will launch a new product. In fact, frequency of product updates or the potential of model renewal and variety of versions has become another aspect in redefining the concept of a favorite brand.

The rapid pace of consumer demand compels companies to keep their products on the edge of technology and competitive in market place; therefore, their development process can be no less aggressive. To achieve optimum results, the products must be continuously improved, based on customer need.

Dufour (1996) is emphatic that many new products, even if unintended, are in most cases redesigns, based on an existing product. This activity, however, cannot be held solely in intuitive order, depending only on empiricism.

The redesign needs to be done through a systematic process that guides the work of the designer and the product development team from identification of the problem until the final design of the product, offering a greater chance of success.

Silva (2001) considers that for small and medium companies to be regarded as pioneers in product development, it is not a critical success factor. So, additional scrutiny is applied to the study of manufacture and assembly, the structured assessments of conditions and the productive resources, internally and externally available, as a means of reducing costs and optimizing deadlines for product launching.

As a consequence, the redesign of products, supported by a Reverse Engineering (RE) approach, and integrated Design for Manufacturing and Assembly (DFMA) is a way these companies manage to launch new products with minimal investment and risk. A survey in the main scientific databases (Emerald, Science Direct and SciELO) revealed that this issue has generated 178 publications in journals during the period from 1980 to 2009, as shown in Figure 1.

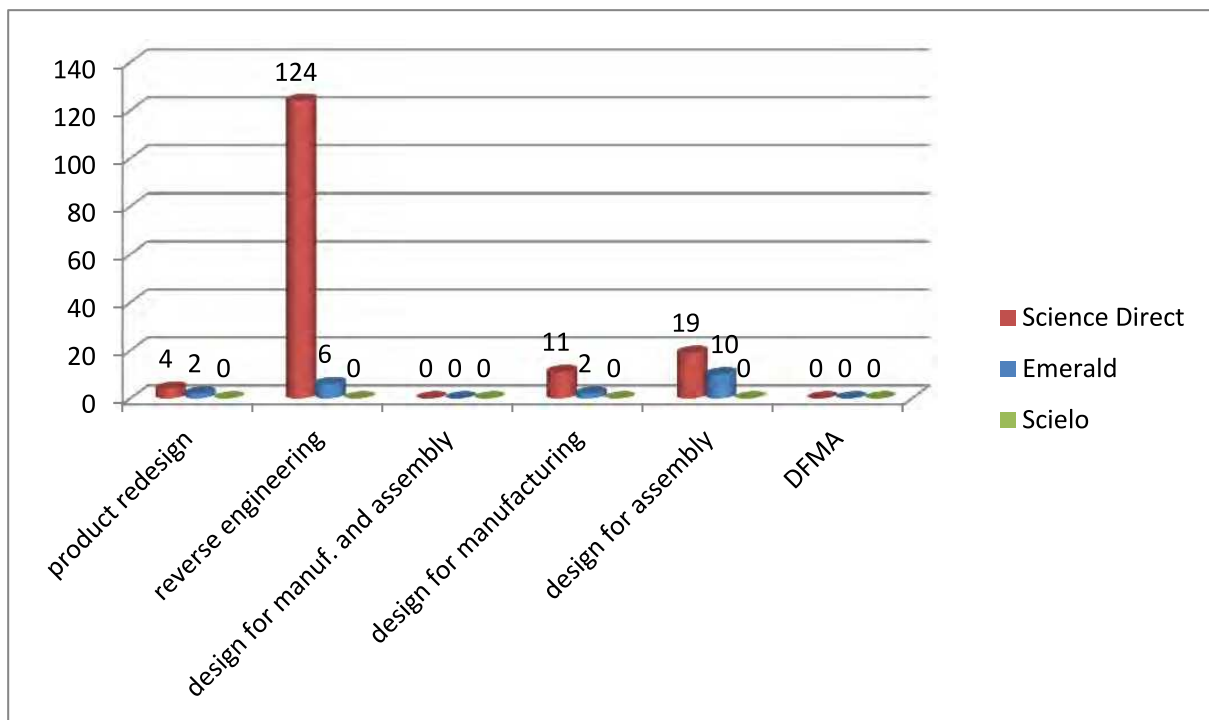

Fig. 1. Publications by keywords in major databases

Figure 2 shows the distribution of these publications within this period, as they are contained in the article title, for the keywords: product redesign; Reverse Engineering; Design for Manufacturing and Assembly; design for manufacturing; design for assembly, and DFMA.

Of note in the analysis is that none of these publications dealt with the integration of RE with DFMA regarding the redesign of products, only with rapid prototyping; thus, this chapter aims to contribute to the knowledge base by filling the gap identified in the literature.

Therefore, the main objective of this study is to analyze the application of a model for the integrated use of the design for manufacturing and the rapid prototyping in a reverse engineering approach in the process of products redesign.

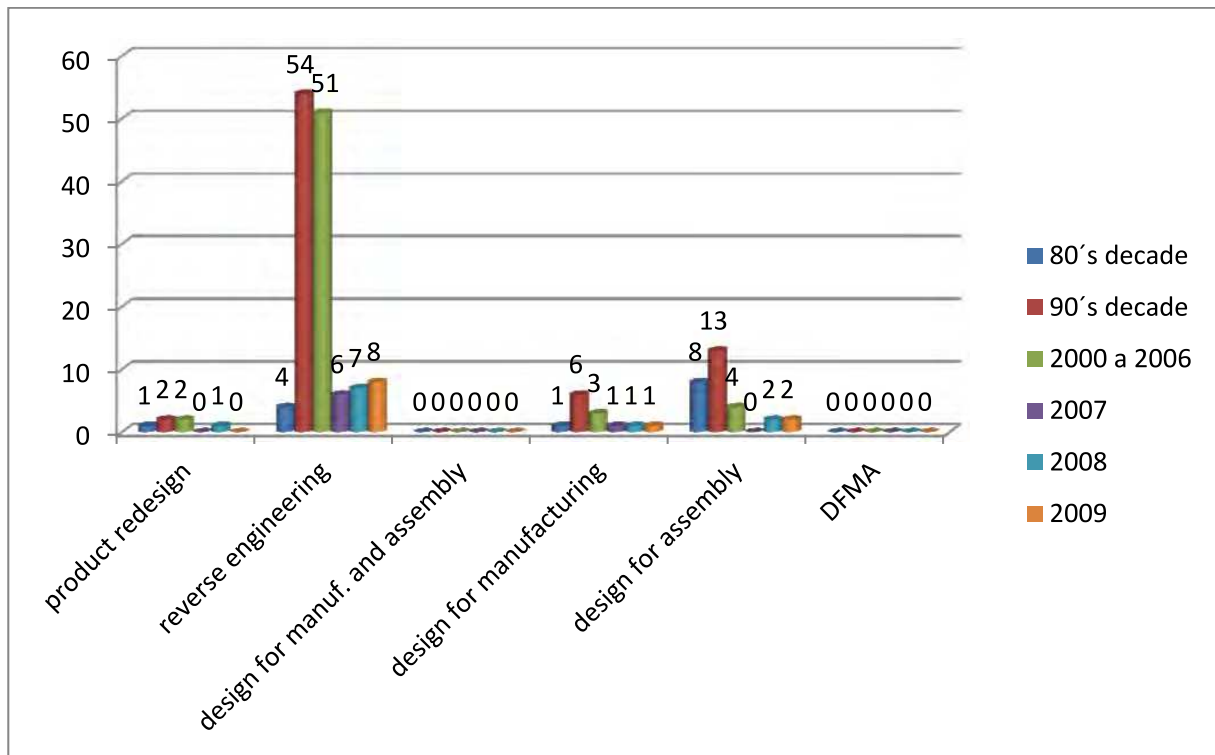

Fig. 2. Publications by keywords between 1980 and 2009

From this main objective on, it is established a secondary objective, to analyze the results from the application of the cited model to reduce production/assembling time, as well as the manufacturing/assembling costs on the redesign of products from the reverse engineering.

The employed research method was the action-research. According to Thiollent (2007) an action-research is a kind of an empirically social research, designed and carried out in close association with an action or with solving a collective problem, in which the researches and participants, representatives of the situation or the problem are involved in a cooperative and participatory way.

This chapter is structured as follows: section 2 presents initially a theoretical framework on the subject studied, followed by section 3 which describes the research method employed. Section 4 analyzes and discusses the results and, finally, section 5 presents the conclusions of the research.

2. Literature review

2.1 Product development process

According to Toledo *et al.* (2008), the product development process (PDP) is considered, increasingly, a critical process to the competitiveness of companies, with a view to a general need for frequent renewal of product lines, costs and development schedules, a more responsive product development to market needs and to companies participating in supplying chain of components and systems, training strategies to participate in joint development (co-design) with customers.

To Rozenfeld *et al.* (2006), develop products consists of a set of activities through which we seek as of market needs and technological possibilities and constraints, and considering the competitive strategies and the company's products, to reach the design specifications of a product and its production process for the manufacture is able to produce it.

Innovation is the key to societal development, rejuvenation and business growth; critical for the long-term survival of a company if it is to operate in the business world. It is also recognized that innovation is more than the invention of new products, but a complete multidimensional concept, which must be viewed from different perspectives in their specific context (Hüsing and Kohn, 2009).

Many products are made of a variety of components which, taken separately, have no influence on the final consumer; for example, in the automotive industry, some components, such as the engine, brake and suspension systems, are used to produce various car systems, provided the relevant interfaces are standardized. That is why different companies (which may or may not be competitors) often agree to cooperate in developing components (Bourreau and Dogan, 2009).

On product development models, Ogliari (1999) mentions that various available types can be found in the following literature: Back (1983), Rosenthal (1992), Vincent (1989), Wheelwright and Clark (1992), Cooper and Edgett (1999), Pahl *et al.* (2005); Rozenfeld *et al.* (2006) and Backet *et al.* (2008), where the primary difference between them are denominations of their phases, but with their sequences and concepts remaining almost constant.

Pahl *et al.* (2005) mentions a product development model (see Figure 3) which highlights the important aspects for the implementation of concurrent engineering; basically considering the anticipation and intersection of the beginning phases to reduce the necessary time for the development of a new product as well as tracking costs. Figure 3 highlighted the use of DFMA.

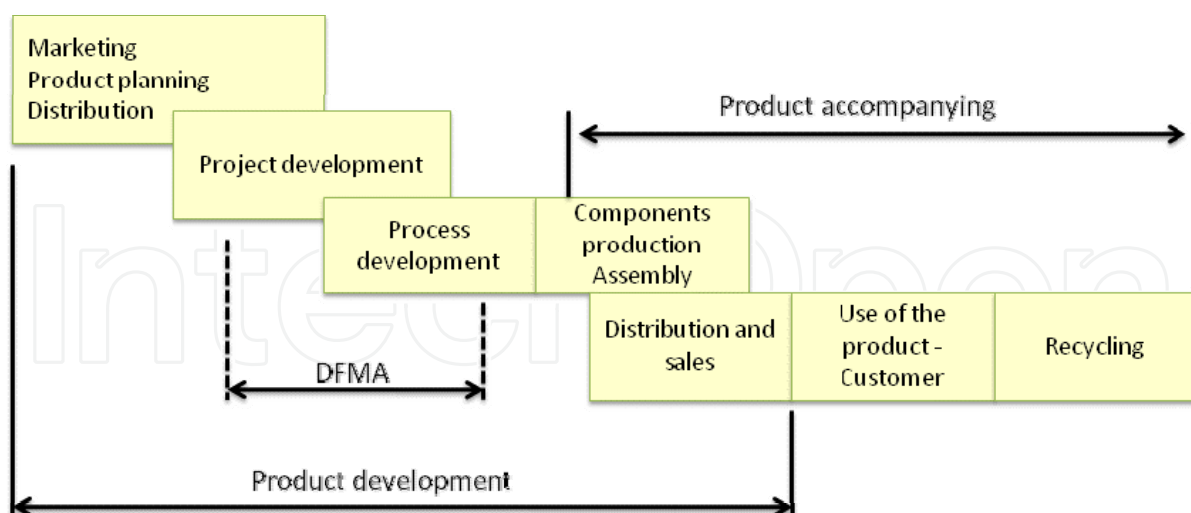

Source: adapted from Pahl *et al.* (2005)

Fig. 3. Reference model for PDP

While creating a product from the perspective of concurrent engineering, the activities of each department of the company are, largely, synchronized. The product is also permanently monitored until the end of its life cycle.

Pahl *et al.* (2005) emphasizes the importance that the development team be composed not only of people directly responsible for the design, but also of others in sectors involved with product development (such as sales, production, marketing, purchasing, engineering), so that the process aspect can be dealt with in order to break out departmental paradigms.

Since, in general, the condition of small and medium enterprise (SME) is not necessarily aggressive (Silva, 2001), due to the need for large investments in research and developing technology, often this understanding and a review of the strategies are the key to reducing costs and is possibly the only way of developing new products in a structured manner and with the greatest chance of success; thus, the Reverse Engineering (RE) approach to the process of product development becomes a plausible method toward achieving innovation within these companies.

2.2 Reverse Engineering (RE)

Reverse Engineering is a very important tool and this technique has been widely recognized as an important step toward developing improved products as well as reducing time and costs in order to achieve profitable production of the new product.

In contrast to the traditional sequence of product development, RE starts typically with the measurement of a reference product, deducing a solid model in order to take advantage of existing technology. The model is later used for manufacturing or rapid prototyping (Bagci, 2009).

According to Kim and Nelson (2005), countries with recent industrialization have used, mainly in the 1960's and 1970's, reverse engineering. Zhu, Liang and Xu (2005) argue that the Chinese process of technology acquisition follows the following line: lines of purchasing and manufacturing techniques from developed countries, modifications and identification of parts and components to achieve product development through RE and, finally, optimize the products.

The innovative process in South Korea is through RE, awaiting for the developed countries to generate new technologies and marked, and then indeed develop their own products (Hobday, Rush and Bessant, 2004).

The RE is useful to guide in understanding the system of interest and allows comparison to be made with similar design models, to see what can actually be used from the technology (Kang, Park and Wu, 2007). Ingle (1994) defines the RE as a process of gathering information in a reference product through its disassembly, in order to determine how it was developed, from its separate components till the final product. His approach clearly supports the application of RE in order to produce as similar as possible to the original, with a level of investment that can guarantee the generation of profits to the enterprise.

The main application of RE is the redesign and improvement of existing parts, wherever improvements are desired, such as reducing costs or even adding new features to the product. In addition, an RE project allows, through the construction of replacements parts, off-line or inaccessible, keep up obsolete equipment in operation (Mury, 2000).

Although widely cited in the literature, Ingle's model (1994) doesn't include the design integration for manufacturing and assembly with rapid prototyping in a reverse engineering approach to the product redesign. This is a scientific contribution that this work seeks to offer.

Another approach that, integrated with RE, can help analyze the redesign of products, is the design for manufacturing and assembly (DFMA).

2.3 Design for manufacturing and assembly

Among the methods to support the design of products that can help to consider the manufacture and assembly during the conception phase, DFMA is used as a support to improve the product concept, or an existing design. After all, the focus of DFMA is to help generate a design considering the company's capacity, to facilitate the final product assembly (Estorilio and Simião, 2006).

The DFMA aims the project and production planning to occur, simultaneously, from a set of principles. Already in the DFMA redesign helps bring the product the best characteristics of production and assembly, seeking to improve quality and reduce manufacturing and assembly time (Dufour, 1996).

According to Stephenson and Wallace (1995) and Boothroyd, Dewhurst and Knight (2002), the requirements of the original design should be reviewed to establish the new DFMA quality requirements, always considering the following basic principles of design for manufacturing (DFM) and design for assembly (DFA): simplicity (reducing the parts number, shorter manufacturing sequence etc.); materials and components standardized; tolerances release (avoid too tight tolerances, which imply high costs); use of more processing materials; reduce secondary operations; use of process special features (to take advantage of the special capabilities of manufacturing processes, eliminating costly and unnecessary operations); avoid limitations in the process.

2.4 Rapid prototyping

Rapid Prototyping (RP) is an innovative technology developed within the last two decades. It aims to produce prototypes relatively quickly to visual inspection, ergonomic evaluation, analysis of shape and dimension and, as a standard for the production of master tools, to help reduce process time for product development (Choi and Chan, 2004).

RP allows designers to quickly create tangible prototypes from their projects, rather than bi-dimensional figures, providing an excellent visual aid during preliminary discussions of the project with colleagues or clients.

Currently on the market there is available a multitude of existing rapid prototyping technologies: Stereolithography (SLA), Laminated Object Manufacturing (LOM), Fused Deposition Modeling (FDM) and Three-Dimensional Printing (3D Printing) (Chen, 2000).

This research focused on the technology of Fused Deposition Modeling (FDM), because it offers lower equipment cost (Kochan, 2000); and as such, it is within reach of small and medium enterprises and research institutions.

The basis of FDM is the deposition of layers on a platform from heated filament, and softening of the material for the creation of the plastic model; simultaneously, other softened wires are forming a support for the free surfaces of the suspended model, providing the structure upon which the model can be finished.

The wires for the model are normally made from ABS (Acrylonitrile Butadiene Styrene), while the brackets are a mixture of ABS and lime. From the generated prototype, the team can: review the adopted product as a reference; test its specifications; test manufacturing or assembly scenarios; propose dimensional or constructive amendments; and establish possible improvements to be made in the end product to be developed.

2.5 Integration of RE with DFMA

In the process of creating a product, from the perspective of concurrent engineering, the activities of each department of the company go, largely, in parallel. There is also a permanent monitoring of the product by the end of its life cycle.

Based on the model analyzed by Pahl *et al.* (2005) (see Figure 1), Souza (2007) proposed a modification on the model in order to include considerations by Ingle (1994), so as to contemplate the development of products using the Reverse Engineering method.

After implementing the Reverse Engineering process, it is necessary to allow the phases to unfold logically within the model. When analyzing Ingle's proposed work (1994), it can be noted there is a major deficiency when considering the need of manufacturing and assembly; thus, Souza's proposed model (2007) contends that the fundamentals of DFMA, when included in the analysis of Reverse Engineering, complements the proposal by Ingle (1994).

For the analysis of these need, Souza (2007) generated an eight steps model, as illustrated in Figure 4.

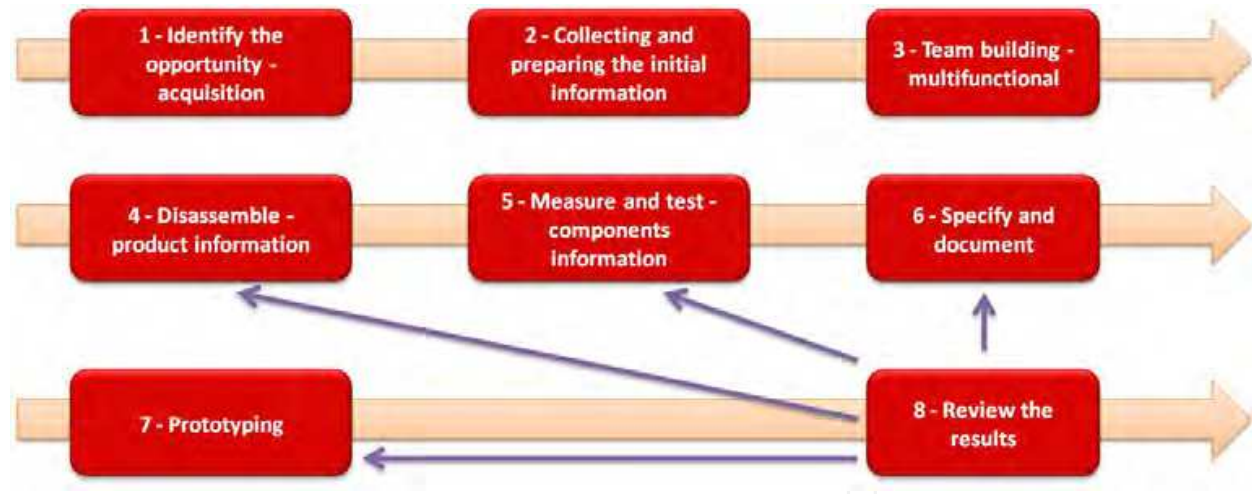

Source: Souza (2007)

Fig. 4. Model proposed for the development of products with DFMA in the Reverse Engineering process

This model does not seek to replace all the phases originally proposed by Pahl *et al.* (2005), but the specific phases of the design development and the process, i.e., the adaptation seeks to optimize the technical process of developing a product, in order to be applied to the existing models, including the redesign of a product, with the expectation of achieving the same final results.

Table 1 provides a brief breakdown of each phase of this model.

Stage	Meaning
Identify the opportunity - acquisition	Identify and recognize the company's marketing position and its operations; and identify the product to be considered as a reference.
Collecting and preparing the initial information	Get an initial survey of the market not only of the reference product, but also for any information that can contribute to a thorough understanding of the product class that is being analyzed. Collect and digest all information that can contribute to the application of Reverse Engineering (RE) and its integration with the principles of Design for Manufacturing and Assembly (DFMA).
Team building - multifunctional	The developing multidisciplinary team needs to have elements that can unite theoretical knowledge with practical and pragmatic details and characteristics of the product manufactured by the company. Everyone on the team ought to be cross-trained in such knowledge, so that no opportunity passes unnoticed.
Disassembled - product information	Systematically analyze the technology and functions of each component and subsystem of the subject product(s) in order to extract information that will be examined in more detail in the next phase. Of cardinal concern is the interaction between the components, with a highly focused view toward all technical details (tolerances, attachments, settings etc.).
Measure and test - components information	Actions taken at this stage are related to measurement and testing of the reference product components, attempting to answer questions related to the product technologies and the processes employed to create the unit and its components.
Specify and document	Documenting the technical information gathered in the previous phase and specifying new information that has been left at this stage by people more directly linked to the details of components and the production process. At this stage the principles of DFMA are used to improve aspects of manufacture and assembly of the product.
Prototyping	Using the prototypes (rapid), within the environment of reverse engineering, to aid as a source of information input in the analysis of DFMA.
Review Results	Conduct a managerial review on all previous phases and how the process is moving forward in relation to time and costs. This phase is conducted by the researchers and project coordinator and should be regarded as the informational hub. After analysis of the prototype, DFMA principles are once again used to optimize the solution for the product redesign.

Source: adapted from Souza (2007)

Table 1. Stages of the model proposed for the development of products with DFMA in the Reverse Engineering process

3. Research method

3.1 Research method definition

The main objective of the research presented in this chapter is to analyze the application of a model for the integrated use of the design for manufacturing and the rapid prototyping in a reverse engineering approach in a product redesign.

From this main objective on, it is established a secondary objective, to analyze the results from the application of the cited model to reduce production/assembling time, as well as the manufacturing/assembling costs on the redesign of products from the reverse engineering.

As to meet these two goals is necessary the intervention of the researcher in the study object, the research method selected was action research. According to Thiollent (2007), action research is a kind of empirical social research which is designed and carried out in close association with an action or to solve a collective problem and in which researchers and participants representative of the situation or the problem are involved in a cooperative and participatory way.

The adopted action-research process was that proposed by Coughlan and Coughlan (2002), which includes planning cycles (context and problem), data collection, data review, data analysis, action planning and evaluation, as Figure 5 shows.

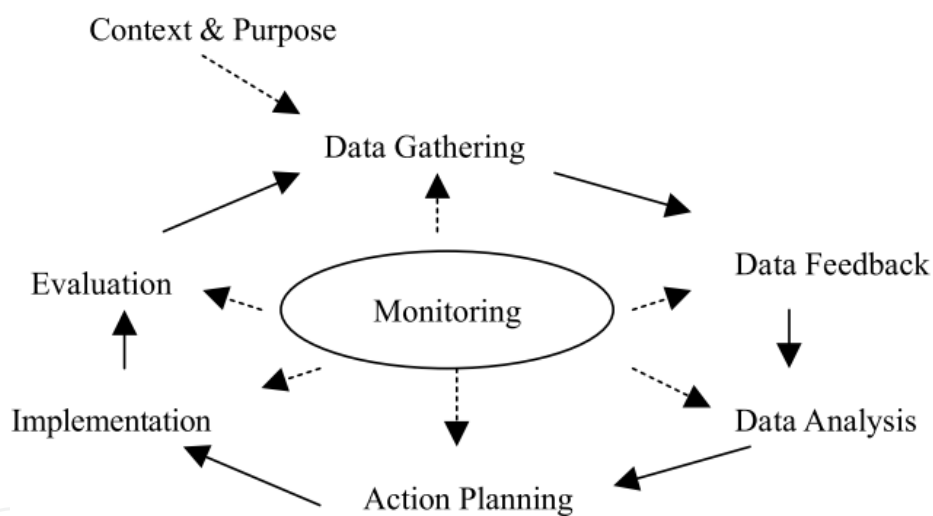

Source: Coughlan and Coughlan (2002)

Fig. 5. Approach to action-research

The following two topics will present the conduction of this research in two companies, located in southeastern Brazil.

3.2 Company A

The company A, founded in 1991, since 1994 successfully manufactures ovens for baking and for industrial kitchens. The company is a Brazilian national leader in the segment of ovens for professional kitchens and a reference in the market it operates.

The research, conducted from January to September 2009, followed the steps of the integrated model, as proposed by Souza (2007), mentioned in section 2.5, in Table 2.

Cycle	Description	Purpose
1	Check the types of lock used in the company, obtaining virtual drawing, access to the lock, take them apart and collect as much data as possible.	Develop a lock system, easy to use, compared to the current model for the oven EC10.
2	Interview the chef cooks of the company. Ask him about the current factory lock system: what's the best? What are the pros and cons of each one? Do they accomplish or not the expected from the system? What could be changed? What is a good difference?	
3	It's been sought as much as possible information about industrial ovens available on the market. It's been got reference locks analysis, according to reverse engineering.	
4	Reference locks have been disassembled and one learned how the systems work. The manufacturing processes were identified, facilities and difficulties to assemble and disassemble were realized. In a word, all the data was collected to start the new design system.	
5	It's been start the design of parts, with the help of software, taking into account all collected information, as well as the use of DFMA principles to ensure facilities for manufacturing of parts and assembly.	
6	After completing the drawing, they were presented to the engineering manager and to the chef cooks, for the mechanism approval. With the requested items modified, finally came an ideal conceptual design.	
7	The parts have been prototyped for testing.	
8	It's been made the assembly of the hybrid prototype and verified the validity of the mechanism, which has been presented to the engineering manager, as well as the chef cooks, for approval. It's been analyzed possible needs for changing and necessary changes made in the conceptual model.	
9	It's been asked the manufacturing, through machining, of metal parts and springs to the purchases responsible.	
10	A door has been built up with the needed slot for testing with the new locking system. An oven for testing had been set up on the door and the available oven. Alignments and adjustments were necessary in the components. The mechanism has been tested several times. The results were presented to director, engineering manager, chef cooks and the purchases responsible.	
11	Problem were identified and possible needs for improvement. Companies that reduced the samples of springs and machining of parts have been contacted, in order to improve results with the springs and simply machining. The machining company was visited for contacting with the responsible and creation of goal for improvements.	
12	Finally, it's been chosen the product. More locking prototypes have been made. Pneumatic devices were created for the product prototype wearing. Prices for large-scale production have been negotiate and ordered to produce the locks in the manufacturing process best suitable for each part.	

Table 2. Summary of the conduct action-research cycles in Company A

3.2.1 Identify the opportunity

Two reference ovens have been identified. One from a German company, a direct competitor in Brazil, and another one from an Italian company, that makes different

products, including locks. They were also used for comparisons purposes all four different of lock currently used in the company.

There were no problems concerning the acquisition, once the German oven had been previously bought by the factory also in order to make use of the RE technique to other parts of the oven.

The Italian lock was provided for the manufacturer, as a sample for possible future sales. Thus, there was no charge.

3.2.2 Collecting and preparing the initial information

All information has been collected by a employee inside the company, since the availability of the German and the Italian locks, besides the locks used at the factory.

To obtain further information, chef cooks, staff, engineering staff, managers, directors were consulted, as well as collected data from de CS (Customer Service), as well as searching the Internet.

3.2.3 Team building



The formed research team was composed by the chef cooks, engineering manager, plant manager, purchases responsible, and the researcher, who supplied the necessary information in all areas. Each one of the participants of the company has more than five years of experience in the development and manufacturing of ovens.







3.2.4 Disassemble (information about the product)



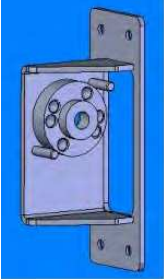

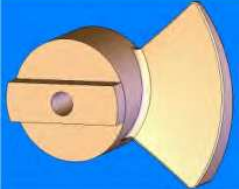



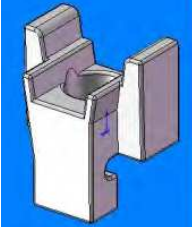

As for the locks used in the company, their virtual drawing was used, allowing to analyze each one regarding the assembly and each part separately, without having to disassemble the product.

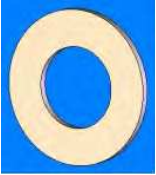
The locks of the German and the Italian ovens were disassembled and analyzed. Through photographs, important information was stored.

Table 3 shows the comparison between the current model EC10 oven lock system and the proposed system. To monitor the work, its whole operation has been registered in virtual drawing, photos and videos, focusing on further analysis.

BEFORE		AFTER	
	Name: Handle Material: Stainless Steel Manufacture: laser cutting, machining and welding Function/feature: lever to turn the system. Heavy and not ergonomic.		Name: Handle Proposed material: Plastic Manufacturing purpose: Injection Function/feature: lever to turn the ergonomic-shaped system to fit the hand.

BEFORE		AFTER	
	<p>Name: Base Material: Stainless Steel Manufacture: Laser cutting, bending, machining and welding. Function/feature: device to be mounted in the side door. It works as a knocker to stop rotating the drive system, ensure different stage of positioning for the set through the holes and supports other parts of the system.</p>		<p>Name: Base Proposed material: Steel Proposed manufacturing: Foundry Function/feature: device to be mounted on the door from inside. It works as a knocker to stop rotating drive system, in addition to host the return spring, nylon bushing component of the spin and snap ring.</p>
	<p>Name: rotating component Material: Bronze Manufacture: machining Function/device: it gets the rotating handle movement and locks the oven door through the conical propeller-shaped shaft.</p>		<p>Name: Rotating component Proposed material: Steel Proposed manufacturing: Foundry Function/feature: it remains inside the base of the lock; it moves fast returning springs, it is limited by rotating movements with knockers, it makes connection between the handle and the locking system.</p>
	<p>Name: Machined Allen screw Material: Steel Manufacture: machining Function/feature: machined part serve for fitting the screw fly; it ensures he attachment of the non-rotating component at the base, keeping the clearance for the movement.</p>		<p>Name: Snap ring Proposed material: Steel Proposed manufacture: on the market Function/feature: it ensures the positioning of the rotating components within the base, while keeping the clearance for the movement.</p>
	<p>Name: Screw fly Material: Steel Manufacture: On the market Function/feature: screwed into the rotating component with the function of limiting the movement of the machined Allen screw, precisely by the machine part.</p>		<p>Name: Base of the shaft/spring Proposed material: Steel Proposed manufacture: Foundry Function/feature: fixed on the spinning component through the screw. It ensures the positioning of the shaft/spring, so that it remains the same with the necessary deformation for the locking function.</p>

BEFORE		AFTER	
	Name: Conical shaft locking component Material: Plastic Manufacture: Foundry Function/feature: set on the side panel with the function of holding the propeller-shaped shaft and through friction, limits the movement and seals the oven chamber.		Name: Two-staged locking screw Proposed material: Steel Proposed manufacture: Foundry and machining Function/feature: fixed in the oven frontal side. It ensures a complete sealing of the oven chamber or a relief stage for releasing steams.
	Name: Washer Material: Brass Manufacture: Machining Function/feature: washer function.		Name: Washer Proposed material: Steel Proposed manufacture: On the market Function/feature: Beyond the function of washer, it is used on the two staged lock to ensure positioning adjustment.
	Name: Plate washer Material: Steel Manufacture: on the market Function/feature: to ensure there is no slack in the machined Allen screw and also allows its sliding.		Name: Bushing Proposed material: Nylon Proposed manufacture: Machining Function/feature: to ensure the rotating component positioning inside the base and avoid the friction between both.
	Name: Allen screw Material: Steel Manufacture: on the market Function/feature: to fix the handle on the rotating component.		Name: Allen Screw Proposed material: Steel Proposed manufacture: to fix the shaft/spring base on the rotating component, through the nut on the handle, which will be fixed on the set at this moment.
	Name: Sphere Material: Steel Manufacture: on the market Function/feature: It remains housed in the rotating component, partially occupying the base holes, at the moment the locking function happens at every stage.		Name: Shaft/spring Proposed material: Stainless steel and spring steel. Proposed manufacture: machining and spring adjustment. Function/feature: next to the two stages lock, it allows the complete sealing of the oven or the lock in the second stage, which allows the door to be relieved for the release of steams.

BEFORE		AFTER	
	Name: Spring Material: Spring steel Manufacture: Spring adjustment Function/feature: to press the housed spheres in the rotating component, so both stages may happens through the holes.		Name: Spring Material: Spring steel Proposed manufacture: Spring adjustment Function/feature: housed in the base and triggered by the rotating component, it makes there is a fast return to the initial position after its drive.

Table 3. Comparison between the current system and the proposed one for the oven lock.

3.2.5 Measure and test (information on the components)

At this phase, we identified the applicability of DFMA during the components analysis, observing:

- premature wear;
- components number reducing;
- alternative materials;
- equipment needed for manufacturing, quality and handling;
- layout of the factory floor.

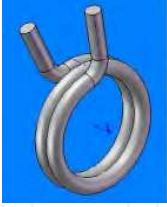
The operation of the locks used in the company was observed on their own ovens. The German lock was observed as how it works, once it could be assembled on its original oven. As for the Italian lock, it was possible to observe only through a simple manual fitting.

The DFMA applicability analysis were carried out and, once the company doesn't produce the lock components, it has been asked the expert professionals' help in manufacturing processes of this kind of component, once they work at two machining companies in the region.

3.2.6 Specify and document

The proposal of a new lock has been modeled through a parametric design software and taking into consideration the information from the previous phases, it has been defined the new product. Each of the new components has been designed, registered and documented accordingly.

3.2.7 Prototyping

All the lock components were prototyped at Federal University of Itajubá (UNIFEI), at the Dimension SST 768 machine, by the Fused Deposition Modeling (FDM), as Figure 6 shows.

3.2.8 Review results

As described in literature, the project went through all the previous phases and, upon completion of these phases, the prototype could be shown to the research team. Having identified new needs, it was necessary to return to some of the previous phases for re-assessment and redesign. After repeating this cycle many times, the final design concept was realized, as shown in Figure 7.

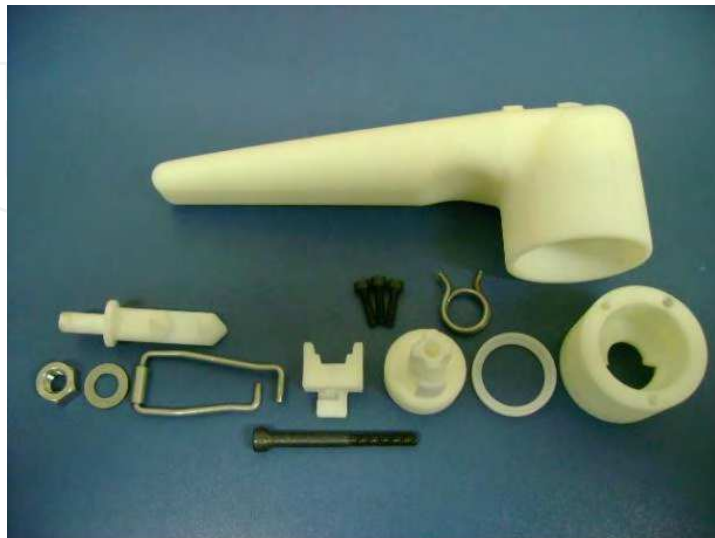

Fig. 6. Prototyped components of the proposed lock system



Fig. 7. Exploded view of the proposed design concept for a locking system

3.3 Company B

Company B is one of three major national suppliers of hour meters for manufacturers of agricultural machinery and parts. The hour meter (a special timer) is an electrical-mechanical device for controlling the length of engagement sessions on machines, equipment and stationary engines.

Among its major applications we find: tractors and general agricultural machinery, forklifts, marine engines, industrial machines and similar mechanisms. This product was chosen for being one of the higher revenue generators for the company, but lately its competitive edge in the market has been threatened by competition from suppliers with more technologically advanced products; as a result, the company is compelled to redesign its product, focusing on reducing its production cost in order to at least maintain its position in the market.

The research followed the steps of the integration model, proposed by Souza (2007), cited in Table 1, presented below.

3.3.1 Identify opportunity

As for the redesign through Reverse Engineering, an hour meter has been chosen as a reference product from a European company, which has commercial dealings in Brazil. This was a joint decision of the production department and the marketing department of the company being studied. The chosen product was considered as a reference for having such high sales in this market.

The technique of redesign, according to Otto and Wood (1998) was adaptive, in view of the need for new subsystems for the redesign of the hour meter to be produced by the company, object of study.

The acquisition of the reference product was possible thanks to the financial support offered by Minas Gerais Research Support Foundation (FAPEMIG), with the announcement "Young Doctors Program", process EDT-538/07, which provided a resource for the research. It is worth notice that the product, result of his research, didn't break any patent or commercial property, once que solutions for the generated subsystems were different from those observed on the reference product.

3.3.2 Collecting and preparing the initial information

This phase is the first one with involved technical characteristics. It has been carried out an initial survey of the marked on measuring instrument for machine panels, agricultural equipment and stationary engines.

All information has been brought together, which could contribute for the integration of reverse engineering with DFMA and the RP: elaboration of the product structures (definition of sets and their components), mapping and cronoanalysis of the hour meter assembling process, definition of standard time for each step of the assembling process and the product assembling raising costs.

A series of non structured interviews has been carried out with the mounting employees to identify their major difficulties on the hour meter assembling process. Table 4 shows some of the identified difficulties.





Set/Component	Illustration	Difficulties
Adaptor set		<p>Manual welding of wires on the adaptor (component injected in ABS). During welding, it could happen the melting of the component in ABS because of being close to the welding equipment, causing non-compliance of the component.</p>
Main support and coil support		<p>The sets were assembled through welding, which if underdone could cause non-compliance on some components produced by ABS injection. For being welded linked, when a non-compliance occurs on some components, the disassembling may cause loss of one or two of the sets.</p>
Support plate glass and display		<p>The assemble of steel plate, display and glass is very difficult, once the clean glass can be touched by the assembling employees, being stained, forcing its disassemble for new cleaning. The display is made on aluminum (more expensive than steel, for example) and its manufacturing process needs stamping and a complete silk-screen process for recording of traces of marking time and engraving for the black and white painting.</p>
Mug (external wrapping)		<p>A different model of mug for any of the three models of hour meters, available for trade (one with lighting with rubber cushioning, another without lighting and another with a smaller size for a specific client).</p>

Table 4. Diagnosis of the parts considered in the redesign

3.3.3 Team building

Table 5 shows a group of research formed for the development of work at the company B.

Member	Formation	Experience
Research coordinator	Doctor in industrial engineering	He works on product developing processes for more than 4 years.
Researcher	Doctor in industrial engineering	Mechanical projects expert.
Scientific initiation scholarship (two)	Graduate student in mechanical engineering	Mechanical projects designs.
Sales manager	Business management	More than five years at the trade of the hour meter.
Quality manager	Technician	More than 20 years on the hour meter production and quality control.

Table 5. Research Team at Company B

3.3.4 Disassemble (information about the product)

The studied hour meter has 11 systems and 87 components as a whole. For the redesign of this product, through reverse engineering, the reference product was totally disassembled, so the research group could analyze its constructive aspects, materials, (probable) assembling process, number of components etc.

The reference product analysis revealed several technical information that could be useful in the comparison of the components similar to the studied hour meter. Table 6 shows a comparison between some of these components.

3.3.5 Measure and test (information on the components)

After being disassembled the product, adopted as a reference, has been reassembled and taken to the lab of the company for testing the burn-in, among others. Some tractor model panels have been bought for testing the installation of the redesigned hour meter.

After this analysis, several meetings among the components of the research group were carried out in order to try to incorporate solutions to the current product, based on the reference product analysis and on the DFMA principles, to improve its assembling process and its cost-goal.

3.3.6 Specify and document

The studied company produced three hour meters models, one of them being to serve a client with a smaller mug (the mug is the wrapping that protects all the other components and helps in the fixation of the hour meter on the tractor panel), one with lighting and a damping rubber and another without lighting (for these two, the mugs are different to hold, or not, on their base a socket set for the bulb).







Reference hour meter		Studied hour meter	
	The main support assembling to the coil support is done through a slot, making it easy the disassemble and substitution of any component.		The main support assembling o the coil support is done through welding, making it difficult the disassembling and risky of damages to one of the supports, in case of substitution of any component.
	The display is made out of steel, in one-piece set, and its face in black was composed of a sticking glued to it.		The display is made out of aluminum and it needs a complex process of silkscreen for painting and recording of traces of time and paintings. It is composed of a glass support (steel) plate.
	Non-existence of the adaptor. The contact between the hour meter and the panel of the tractor was carried out simply by the terminals without the need of wires, used by hour meters of the studied company.		Adaptor (injected on ABS) with wires manually welded.

Table 6. Comparison of components between the studied hourmeter and the reference one

One of the group suggestions was to propose as well a single mug for the hour meter, to be projected. Other similar analyses were carried out for another sets and components. All the suggestions offered by the research group were documented and the changes on the components or sets were specified. Table 7 shows some of the proposed solutions for the company as a result of the product redesign.





Component	Illustration	Proposed solution
Solution 1: adaptor		<ul style="list-style-type: none"> - wires elimination; - wires welding process elimination; - contact through terminals.
Solution 2: main support and coil support		<ul style="list-style-type: none"> - welding eliminations for the junction of both plates; - ease assembling through fitting.
Solution 3: support plate glass and display		<ul style="list-style-type: none"> - single component instead of two; - display on steel instead of aluminum; - marking with adhesive instead of silkscreen; - fins to pass lightings (no longer by bulbs, but by leds); - reference fixation points to ease the assembling.
Solution 4: mug		<ul style="list-style-type: none"> - Possibility of a single mug type, of only one dimension, to serve all the clients and for products with and without lighting.

Table 7. Proposed solutions for the hour meter redesign

3.3.7 Prototyping

For the presentation of the proposed solutions were built rapid prototypes of components, to facilitate understanding by all involved and provide performing tests (dimensional and visual).

The prototypes were made in the rapid prototyping machine Strasys Dimension SST 768, of the Innovation Products Lab (Laboratório de Inovação de Produtos - LIP) from the Optimization of Manufacturing and Technology Innovation Nucleus (NOMATI) of the Federal University of Itajubá (UNIFEI) in Brazil.

For each changed system, it had built its corresponding prototype. Later a hybrid prototype has been built for discussion and the accomplishment of test by the team. Figure 8 shows the hybrid prototype built for the accomplishment of tests.



Fig. 8. Hybrid prototype

3.3.8 Review results

The tests have provided opportunities for improvement on the redesigned components. For example, the vibration test showed that the sets together by snaps showed a performance similar do the original product (union by welding).

This assured the company owners that the alteration proposals could be taken forward, minimizing the risks of failure. This information was registered on the company database as learned lessons.

4. Discussion

According to Coughlan and Coughlan (2002) the data critical analysis aspect in the action-research is that it is cooperative, and the researcher and the members of the client system (for example the managers' team, a group of clients etc.) carry it out together.

Such cooperating approach is based on the supposition that cooperators know much better their company, they know what is going to work and, mainly, they will be the ones to implement and follows the actions to be implemented. So, their involvement is crucial.

In this way, the criteria and tools for analysis were discussed between the researcher and his team of cooperators in the companies, so to be directly linked to the purpose of the research in the core of the interventions.

The following are the research result analysis in the companies A and B.

4.1 Company A

Twelve aspects were identified for comparison of the final results between the current lock system and the new proposed system. Table 8 shows, sparingly, these aspects.

The current lock has 13 components, as it is necessary two spheres and two springs. This is not necessary on the new lock, which has 11 components, representing about 15% reduction on the components number.

As for the current lock they use five manufacturing processes: laser cutting, bending, machining, welding and spring arrangement. As for the new lock, there are only four: plastic injection, machining, spring arrangement and casting, a 20% reduction on the process number. The current lock manufacturing time was informed by the supplier, which makes the product, involving the laser cutting, machining, welding, spring arrangement and finish, resulting in a total time of 220 minutes.

Beyond the manufacturing, the set assemble is also made by this supplier and the lock needs around 480 seconds to be ready for order. This service whole cost is of \$ 124.00.

Making contact with suppliers, discussing methods and making estimates for the new lock, one can estimate costs in around \$ 45.00 (a 64% cost reduction) involving all the necessary components and the time for manufacturing all the components and the necessary time for manufacturing them in around 20 minutes (a 91% reduction on the manufacturing time). Through the machined assembled prototype, one can estimate a 150 seconds time (reduction of 68%) for the system assembling.

Requisite	Before	After
Number of components	13	11
Number of manufacturing processes	5	4
Time of manufacturing components (minutes)	220	20
Product costs (\$)	124.00	45.00
Time of system assembling (seconds)	480	150
Difficulties/Problems	7	3
Benefits	Robust system, meets the requirements like locks and consolidated in the company.	Innovative lock, easy to use and good resources.
Maintenance	Difficult, normally the system is changed as a whole.	Easy assembling and disassembling.
Functions	3	5
Operation	OPENING: 90 degrees to the left, medium strength. RELIEF: 45 degrees to the left, medium strength. CLOSING: pressure on the door, 90 degrees to the right, great strength.	OPENING: 50 degrees to the left or to the right, maintains a small force. RELIEF: degrees to the left or to the right and release, small force. CLOSING: light pressure or by door slam.
Relief system	Inefficient.	It allows a 20 millimeter relief.
Ergonomics	Tough mechanism, handle with straight edges.	Lightweight mechanism, handle with rounded corners.

Table 8. Lock project system final comparative results analysis

Through a Customer Service system and technical personal assistance one could identify some problems on the current lock:

- expensive manufacturing process, due to the amount and machining complexity of some components;
- leftover material (scrap);
- over time or excessive handling, the system generates a gap caused by wear, once the lever presses the set at every closing of the door;
- for being a locking door system through friction between both parts, until they fit it's necessary to force a bit to overcome that friction, which makes the system to be a bit tough;
- There is no system to help spring returning movements.
- The existing relief generates a very small opening between the door and the trim, which is not perceived by the client, so it is not used. It also can be used when the client considers it to be inefficient for steam release;

- it is a complicate system for assembling and disassembling, due the presence of screw fly, spheres and springs, which can be used in a proper way for a lay person. Normally when a gap occurs, it is necessary to change the whole lock;
- for being made through the union of a three-millimeter layers, generating a six-millimeter cable, the squares end up being straight, which make the handling a bit painful, once there is the necessity of forcing one of the edges;
- if the lock, after the opening, gets back to the vertical position, after closing the oven the rotating component will crash on the panel and, quite probably, smash it.

After the first tests with the new lock, it was possible to reach preliminary conclusions as to some difficulties: since it is a system in which the shaft/spring must tightly fit into the lock, it is necessary to focus on the door positioning, assuring a perfect alignment; if, due to the oven manufacturing, there is some dimension error, which happens very frequently (due to the existence of processes like punching, bending, fitting with no feedback and welding), it is necessary the use of washers for the correct positioning of the two-stage lock; as some of the proposed components will be machined, it is necessary some big initial investments for the manufacture of machining model, so much for metals as for plastic, in an approximately cost of R\$ 35,000.00.

On the other hand to these difficulties, it was possible to see the benefits of each lock. The current one has a robust system, which complies the market demands and it's consolidated in the company. The new proposal is innovative (in relation to the models used in the company), easy to used and resourceful.

The current system is difficult to maintain, once the exchange of a component rarely solves the problem. Normally the system is substituted as whole, beyond the complexity of assembling and disassembling. The new lock is quite easy to assemble and disassemble, the major components can be exchanged with the removal of a screw. The system has less wear, once it suffers mostly axial strength.

As for its functions, it is possible to observe in the current lock the following: to ensure the oven total sealing; provide relieve system, to serve as a stem for opening and closing of the oven. The new lock closing features include the functions of the current system and more: to open the oven with a twist of the handle, for the right or for the left; to assure a fast return of the handle after been moved.

With regard to the operation, there has been an improvement related to the opening, relieve and closing.

The current lock relieve system is considered to be inefficient, as it allows a very short distance for steam relieve, normally not noticeable by clients. The new lock relieve system allows a 20 mm relieve, and can be used with light touch on the handle. It cannot be driven by choice, in case the handle is activated and remains at 50 degrees of twist at the opening.

The new lock allows the closing (lock) of the door, if it is moved with a light twist of the body when the operator is busy with his hands e doesn't want to leave the oven door open.

As for ergonomic, the current lock is considered by the team as a tough mechanism, needing to much strength for moving.

The handle has straight corners, which can hurt with daily use. On the new lock the mechanism is light, it can be operated with a single finger; it is easy to be closed and it has rounded square to fit the hand.

After getting all the components in material resistant enough for testing the mechanism, there has been a meeting with all the responsible team for a test. Figure 9 shows the prototype ready for testing.



Fig. 9. New lock assembled for a test

With the use of a new door with proper drilling for the new lock, a mechanism has been assembled in the proposed oven and its operation can be tested.

All the team members handled the lock on different ways, according to their perceptions of the demands the new product must accomplish.

The new lock has been approved by everybody, as some accounts showed. The Major Cook stated: "it doesn't make any difference for me the kind of lock; I like the current system, but the new one is really easier. The purchase responsible added: I liked it a lot, but now we must choose the materials, manufacturing processes and where it is going to be made. We are on the right path, the competitors are bringing on new things and this lock will be a difference for our oven". Finally, the Plant Director said: "the system is very cool. Let's define if it is really accomplished in this prototype, to make more functional prototypes and testing. We can use pneumatic actuators to check the wears and go on adjusting till it can be introduced in our line".

4.2 Company B

The proposal of solutions, among those presented at Table 7, provided several benefits for the studied product at Company B.

The **solution 1** (see Table 7) provided the reduction of two components (wires) and their welding onto the adaptor. Previously the adaptor had distinct model for each hourmeter model. Such proposal allowed that only one of the existing models kept on being used,

diminishing the components structure and improving their manufacturing planning. The passage of energy between the hour meter plate C1 and the terminal had to be made by two springs, internally assembled in their own accommodations in the mug. This assembling process is much faster than the previous one, beyond spring costs being inferior from the wire costs (including their cutting and preparation), as well as the insertion time to be inferior from that necessary one for the wire welding of the other components.

The **solution 2** provided mainly assembling ease of two sets. The welding process has been eliminated, taking advantage of the assembling concept through fitting of the reference product. However, the used concept in the solution proposal was different from the concept found in the reference product. In the proposal deep changes have been avoided in the components, to prevent the necessity of new models projects for the components injection. With the used concept, some small adjustments were enough in the existing models for the manufacturing of the new components. This proposed solution, beyond reducing the assembly time of these two sets, allows them to be disassembled at any time during the assembly process, in the case of non-compliance in any of the other components.

The **solution 3** helped reduce the cost component, since the display no longer needs to be produced in aluminum, and the new component can be produced in galvanized steel, as was the support of the glass. In addition, the use of an adhesive to the display, eliminating the silk screen process and all the involved sub-processes (cleaning, painting and silk), reducing cost and assembling time. The new component reduces the number of components, as it brought together two components into only one (simplification of product structure).

Finally, the **solution 4** was a natural result from previous ones, once it had been possible to propose only one mug as a wrapping and protection of the hour meter components. This solution simplifies the product structure, favoring a product standardization and reducing the failure possibility in the assembling because of the wrong mug for the right product model.

The proposed improvements will represent a significant reduction in the product several aspects and of its assembling/manufacturing process. Beyond, in case of testing failures, the hour meter can be disassembled and only those failing parts be exchanged, which is not possible in the current hourmeter.

Beyond the improvement on the assembling time, the proposed solutions will allow a significant reduction in the hour meter cost-goal, allowing an increase of its competitiveness on the market.

Table 9 shows a general final summary of the benefits provided with a redesigned product, not only for the four proposal shown in Table 7.

Regarding the reduction of the product cost-goal, the analysis of the research team evaluates a reduction of 33%, providing opportunities to the company to compete with its direct competitors for sharing the market.

In the previous Company B product redesign final results analysis they were not taken into account the improvements made in the product electronics parts, once they were not contemplate in the scope of the accomplished work.

CONJUNTO	COMPONENTS REDUCTION (%)	PROCESS REDUCTION (%)	ASSEMBLING AND MANUFACTURING TIME REDUCTION (%)
Adaptor	29	23	81
Complete plate	29	36	44
Embedding - several	17	0	30
Embedding - box	17	24	62
Embedding - socket	100	100	100
Embedding - accessories	0	8	13
Total	11	15	47

Table 9. Summary of the final results provided in the hour meter redesign

5. Conclusions

It is considered that the goals of this work have been achieved, once from the studied concepts in the theoretical consideration it was possible to analyze a model for the product redesign, which provided reduction in the components number in the assembling processes number, the assembling/manufacturing time and the product redesigning cost-goal.

Preliminary analyzing at Company A the difference between locks costs, manufacturing time, assembling time and facilities by the new model, one sees it will be a very positive change and, although some high cost with the machined model acquisition, such an amount will be rewarding with the time.

The recommendations for the Company B product were made with the care not to significantly alter the current company's infrastructure in terms of the machines and tools, facilitating the development of the presented solutions and not needing any big investment for its deployment.

The research showed too that the integration of design for manufacturing and assembly (DFMA) with the rapid prototyping, in a reverse engineering approach, as proposed by Souza (2007), is an adequate strategy for the improvement (redesign) of products in small sized companies. The reverse engineering allows the study of other technologies or manufacturing and assembly solutions, components standardization, secondary operations reduction, among others.

The model proposed by Souza (2007) showed consistent for making product redesigns. It is expected that the current work can contribute to the incremental validation of this model. It is advised that other researchers use this same model in another similar research, aiming a possible generalization of the same future.

6. Acknowledgments

The authors would like to thank FAPEMIG (process EDT-538/07 and TEC-PPM-00043-08) and CNPq (project DT 312419/09) for research funding provided by in the form of research projects and scientific initiation scholarship, without which this research would not be

possible. Our thanks also to employees and directors of the two researched companies, which allowed us to accomplish the current research.

7. References

- Back, N. *Metodologia de projeto de produtos industriais*. Rio de Janeiro, RJ, Editora Guanabara Dois, 1983.
- Back, N.; Dias, A.; Silva, J. C.; Ogliari, A. *Projeto Integrado de Produtos: Planejamento, Concepção e Modelagem*. Porto Alegre: Editora Manole, 2008.
- Bagci, E. Reverse engineering applications for recovery of broken or worn parts and re-manufacturing: Three case studies. *Advances in Engineering Software*, v. 40, p. 407-418, 2009.
- Boothroyd, G.; Dewhurst, P.; Knight, W. *Product development for manufacture and assembly*. Second edition revised and expanded. New York: Marcel Dekker, 2002.
- Bourreau, M.; Dogan, P. Cooperation in product development and process R&D between competitors. *International Journal of Industrial Organization*. Doi: 10.1016/j.ijindorg.2009.07.010, 2009.
- Chen, L. C. Reverse engineering in the design of turbine blades - a case study in applying the MAMDP. *Robotics and Computer Integrated Manufacturing*, v. 16, n. 2-3, p. 161-167, 2000.
- Choi, S. H.; Chan, A. M. M. A virtual prototyping system for rapid product development. *Computer-Aided Design*, v. 36, p. 401-412, 2004.
- Cooper, R. G.; Edgett, S. J. *Product Development for de Service Sector. Lessons from market leaders*. New York: Basic Books, 1999.
- Coughlan, P.; Coughlan, D. Action research for operations management. *International Journal of Operations & Production Management*, v. 22, n. 2, p.220-240, 2002.
- Dufour, C. A. *Estudo do processo e das ferramentas de reprojeto de produtos industriais, como vantagem competitiva e estratégia de melhoria constante*. Dissertação de mestrado. Universidade Federal de Santa Catarina, Florianópolis, 1996, 122p.
- Estorilio, C.; Simião, M. C. Cost reduction of a diesel engine using the DFMA method. *Product Management & Development*, v. 4, n. 2, p. 95-103, 2006.
- Gautam, N.; Singh, N. Lean product development: Maximizing the customer perceived value through design change (redesign). *International Journal of Production Economics*, v. 114, p. 313-332, 2008.
- Hobday, M.; Rush, H.; Bessant, J. Approaching the innovation frontier in Korea: the transition phase to leadership. *Research Policy*, v. 33, p. 1433-1457, 2004.
- Huang, G. Q.; Mak, K. L. Design for manufacture and assembly on the Internet. *Computers in Industry*. v. 38, p. 17-30, 1999.
- Hüsig, S.; Kohn, S. Computer aided innovation. State of the art from a new product development perspective. *Computers in Industry*, v. 60, p. 551-562, 2009.
- InglE, K. A. *Reverse Engineering*. McGraw-Hill, New York, 1994.
- Kang, Y.; Park, C.; Wu, C. Reverse-engineering 1-n associations from Java bytecode using alias analysis. *Information and Software Technology*, v. 49, p. 81-98, 2007.
- Kim, L.; Nelson, R. *Tecnologia, Aprendizado e Inovação: As Experiências das Economias de Industrialização Recente*. Edição do original estadunidense (2000). Campinas: Unicamp, 2005.

- Kochan, A. Rapid prototyping gains speed, volume and precision. *Assembly Automation*, v. 20, n. 4, p. 295-299, 2000.
- Mury, L. G. M. *Uma metodologia para adaptação e melhoria de produtos a partir da engenharia reversa*. Dissertação de mestrado. Programa de Pós-Graduação em Engenharia de Produção. Universidade Federal do Rio Grande do Sul - Escola De Engenharia, Porto Alegre, 2000, 89p.
- Ogliari, A. *Sistematização da concepção de produtos auxiliada por computador com aplicações no domínio de componentes de plástico injetado*. Tese de Doutorado, PPGEM da Universidade Federal de Santa Catarina, Florianópolis, 1999.
- Otto, K. N.; Wood, K. L. Product evolution: a reverse engineering and redesign methodology. *Research in Engineering Design*, v. 10, p. 226-243, 1998.
- Pahl, G.; Beitz, W.; Feldhusen, J.; Grote, K. H. *Projeto na Engenharia: fundamentos do desenvolvimento eficaz de produtos, métodos e aplicações*. 6ª edição, São Paulo: Editora Edgard Blücher, 2005.
- Rozenfeld, H.; Forcellini, F. A.; Amaral, D. C.; Toledo, J. C.; Silva, S. L.; Alliprandini, D. H.; Scalice, R. K. *Gestão de desenvolvimento de produtos: uma referência para a melhoria do processo*. São Paulo: Editora Saraiva, 2006.
- Rosenthal, S. R. *Effective Product Design and Development – How to cut lead time and increase customer satisfaction*. New York, N.Y. Irwin Professional Publishing, 1992.
- Salgado, E. G.; Mello, C. H. P.; Silva, C. E. S. Da; Oliveira, E. S.; Almeida, D. A. Análise da aplicação do mapeamento do fluxo de valor na identificação de desperdícios do processo de desenvolvimento de produtos. *Gestão e Produção*, v. 16, n. 3, p. 344-356, 2009.
- Silva, C. E. S. *Método para avaliação do desempenho do processo de desenvolvimento de produtos*. Tese (Doutorado em Engenharia de Produção). Universidade Federal de Santa Catarina, Florianópolis, 2001.
- Souza, J. F. *Aplicação de projeto para manufatura e montagem em uma abordagem de engenharia reversa: estudo de caso*. Dissertação de Mestrado. Programa de Pós-Graduação em Engenharia de Produção. Universidade Federal de Itajubá, Itajubá/MG, 135p, 2007.
- Stephenson, J.; Wallace, K. Design for reability in mechanical systems. *International Conference on Engineering Design, ICED 95*. Praha, August 22-24, 1995.
- Thiollent, M. *Metodologia da pesquisa-ação*. 15ª edição, São Paulo: Editora Cortez, 2007.
- Toledo, J. C.; Silva, S. L.; Alliprandini, D. R.; Martins, M. F.; Ferrari, F. M. Práticas de gestão no desenvolvimento de produtos em empresas de autopeças. *Produção*, v. 18, n. 2, p. 405-422, 2008.
- Vincent, G. *Managing new product development*. New York: Van Nostrand Reinold, 1989.
- Wheelwright, S. C.; Clark, K. B. *Revolutionizing product development – Quantum leaps in speed, efficiency, and quality*. New York: Free Press, 1992.
- Zhu, J.; Liang, X.; Xu, Q. The cause of secondary innovation dilemma in chinese enterprises and solutions. *Proceedings of the 2005 IEEE International Engineering Conference*, v. 1, p. 297-301, 2005.

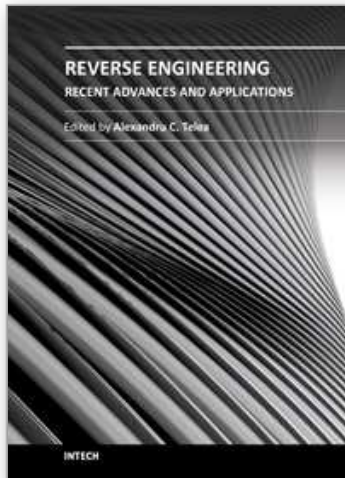

Reverse Engineering - Recent Advances and Applications

Edited by Dr. A.C. Telea

ISBN 978-953-51-0158-1

Hard cover, 276 pages

Publisher InTech

Published online 07, March, 2012

Published in print edition March, 2012

Reverse engineering encompasses a wide spectrum of activities aimed at extracting information on the function, structure, and behavior of man-made or natural artifacts. Increases in data sources, processing power, and improved data mining and processing algorithms have opened new fields of application for reverse engineering. In this book, we present twelve applications of reverse engineering in the software engineering, shape engineering, and medical and life sciences application domains. The book can serve as a guideline to practitioners in the above fields to the state-of-the-art in reverse engineering techniques, tools, and use-cases, as well as an overview of open challenges for reverse engineering researchers.

How to reference

In order to correctly reference this scholarly work, feel free to copy and paste the following:

Carlos Henrique Pereira Mello, Carlos Eduardo Sanches da Silva, José Hamilton Chaves Gorgulho Junior, Fabrício Oliveira de Toledo, Filipe Natividade Guedes, Dóris Akemi Akagi and Amanda Fernandes Xavier (2012). Integrating Reverse Engineering and Design for Manufacturing and Assembly in Products Redesigns: Results of Two Action Research Studies in Brazil, *Reverse Engineering - Recent Advances and Applications*, Dr. A.C. Telea (Ed.), ISBN: 978-953-51-0158-1, InTech, Available from:

<http://www.intechopen.com/books/reverse-engineering-recent-advances-and-applications/integrating-reverse-engineering-and-design-for-manufacturing-and-assembly-in-the-redesigns-of-product>

INTECH
open science | open minds

InTech Europe

University Campus STeP Ri
Slavka Krautzeka 83/A
51000 Rijeka, Croatia
Phone: +385 (51) 770 447
Fax: +385 (51) 686 166
www.intechopen.com

InTech China

Unit 405, Office Block, Hotel Equatorial Shanghai
No.65, Yan An Road (West), Shanghai, 200040, China
中国上海市延安西路65号上海国际贵都大饭店办公楼405单元
Phone: +86-21-62489820
Fax: +86-21-62489821

© 2012 The Author(s). Licensee IntechOpen. This is an open access article distributed under the terms of the [Creative Commons Attribution 3.0 License](#), which permits unrestricted use, distribution, and reproduction in any medium, provided the original work is properly cited.

IntechOpen

IntechOpen