

# We are IntechOpen, the world's leading publisher of Open Access books Built by scientists, for scientists

**4,800**

Open access books available

**122,000**

International authors and editors

**135M**

Downloads

Our authors are among the

**154**

Countries delivered to

**TOP 1%**

most cited scientists

**12.2%**

Contributors from top 500 universities



**WEB OF SCIENCE™**

Selection of our books indexed in the Book Citation Index  
in Web of Science™ Core Collection (BKCI)

Interested in publishing with us?  
Contact [book.department@intechopen.com](mailto:book.department@intechopen.com)

Numbers displayed above are based on latest data collected.

For more information visit [www.intechopen.com](http://www.intechopen.com)



# Hybrid Genetic Algorithm-Support Vector Machine Technique for Power Tracing in Deregulated Power Systems

Mohd Wazir Mustafa, Mohd Herwan Sulaiman\*,  
Saifulnizam Abd. Khalid and Hussain Shareef

*Universiti Teknologi Malaysia (UTM), Universiti Malaysia Perlis (UniMAP) and  
Universiti Kebangsaan Malaysia (UKM)  
Malaysia*

## 1. Introduction

The electric power industry is under deregulation in response to changes in the law, technology, market and competition. The aim of deregulation is to optimize the system welfare by introducing competitive environment, mainly among the power producers. Developing fair and transparent power flow and loss allocation method has been an active topic of research, with many transactions taking place at any time.

In the last decades, several power flow tracing algorithms have been proposed in literature mainly from physical flow approach (Bialek & Tam, 1996; Wu et al., 2000; Sulaiman et al., 2008; Pantos et al., 2005) and circuit theory approach (Teng, 2005; Wen-Chen et al., 2004; Mustafa et al., 2008a; Lo & Alturki, 2006). The concept of proportional sharing principle has been proposed by (Bialek & Tam, 1996). This approach has a drawback in handling the transmission losses by introducing fictitious nodes on every lossy branch which will causes the expansion of distribution matrix. The graph method was proposed by (Wu et al., 2000) where the method is basically using the searching technique of the paths and routes from a particular generator to a particular load. The adaptation of the methods from (Bialek & Tam, 1996) and (Wu et al., 2000) has been proposed in (Sulaiman et al., 2008) for tracing the power and loss in deregulated power system. However, the main disadvantage of this approach is it cannot be applied for the circular power flow system. Modification of (Bialek & Tam, 1996) has been done in (Pantos et al., 2005) to trace the real and reactive power by introducing decoupled power flow to overcome the lossy system problem. This method introduces equivalent model of a line for reactive power tracing. The effects of line charging to original generators and loads are integrated. Nevertheless, the actual power contribution from generators to loads has been ignored.

The uses of circuit theory in power tracing have been introduced in (Teng, 2005; Wen-Chen et al., 2004; Mustafa et al., 2008a; Lo & Alturki, 2006). In (Teng, 2005), a method that applies

---

\* Corresponding Author

superposition theorem to trace the power flow and loss in deregulated system has been proposed. The integration of Y-bus matrix with the equivalent impedance of load bus is performed before this integration matrix is inverted into Z-bus matrix. Then, the superposition theorem is applied so that the current injection can be allocated to individual generators. The method that uses basic circuit theory and partitioning the Y-bus matrix to decompose the voltage of load buses as function of the generators' voltage has been proposed in (Wen-Chen et al., 2004). This partitioning technique also has been extended in (Mustafa et al., 2008; Lo & Alturki, 2006). The method from (Wen-Chen et al., 2004) is re-evaluated to represent each load current as function of generators' current and load voltages named as modified nodal equations (MNE) (Mustafa et al., 2008a). However, there are some conditions where the tracing at certain lines or loads could be greater than the power produced by its generation. In (Lo & Alturki, 2006), partitioned Y-bus is applied to design a voltage participation index (VPI) together with the concept of current adjustment factors (CAF) for the reactive power tracing algorithm. CAF is the transformation of complex matrix coefficients for adjustment of non-linearity of the network due to real and imaginary factor interactions. The problem of CAF is it will be very complex if implemented for large system.

In related work based on machine learning, an application of Artificial Neural Network (ANN) into reactive power tracing has been proposed in (Mustafa et al., 2008b). The MNE technique has been utilized as a teacher to train the ANN model. However, ANN is time consuming in the training process. The hybrid of Genetic Algorithm (GA) and Least Squares Support Vector Machine (LS-SVM) to trace the transmission loss has been proposed in (Mustafa et al., 2011). The improvement from (Bialek & Tam, 1996) has been done in tracing the transmission losses. It then is used as a teacher to train the GA-SVM model. However, same with (Bialek & Tam, 1996; Wu et al., 2000; Sulaiman et al., 2008), the technique cannot handle the system with circular or loop flow.

This paper basically proposes the same hybrid technique as proposed in (Mustafa et al., 2011), where the GA-SVM is utilized to trace the real and reactive power from individual generators to loads simultaneously. GA is utilized as an optimizer to find the optimal values of LS-SVM hyper-parameters which are embedded in LS-SVM model. The supervised learning paradigm is used to train the LS-SVM model where the Superposition method (Teng, 2005) is utilized as a teacher. Based on converged load flow and followed by superposition method for power tracing procedure, the description of input and output of the training data are created. The GA-SVM model will learn to identify which generators are supplying to which loads in term of real and reactive power in concurrently. In this paper, IEEE 14 bus system is used to illustrate the effectiveness of proposed method compared to that of the superposition method.

## 2. Superposition method as a teacher

Superposition method was proposed by (Teng, 2005) where it is based on basic circuit theories including KCL, KVL and superposition law. Same with other tracing methods, this method also requires obtaining the solved load flow prior the tracing can be applied. After converged power flow solution, the power tracing is started by obtaining the contribution of voltages and currents which are using the superposition law concept, equivalent impedance and equivalent current injection. Generators in the system are treated as equivalent current

injection which injects the currents into the system by using the following expressions (Teng, 2005):

$$S_{n,G} = (P_{n,G} + jQ_{n,G}) \quad (1)$$

$$I_{n,G} = \left( \frac{P_{n,G} + jQ_{n,G}}{V_{n,G}} \right)^* \quad (2)$$

where  $n$  is number of generator,  $V_{n,G}$  is the generator bus voltage,  $P_{n,G}$  is the real power and  $Q_{n,G}$  is the reactive power for the generator bus.

For a load bus  $i$ , the corresponding equivalent impedance,  $Z_{i,L}$  can be obtained using the following expression:

$$Z_{i,L} = \frac{V_{i,L}}{I_{i,L}} = \frac{|V_{i,L}|^2}{P_{i,L} - j(Q_{i,L} - Q_c)} \quad (3)$$

where  $V_{i,L}$ ,  $I_{i,L}$  and  $S_{i,L} = [P_{i,L} - j(Q_{i,L} - Q_c)]$  are the voltage, current and apparent power of load bus  $i$  including the effect of injected MVAR that obtained from the converged load flow solution respectively. The equivalent impedance for each load now is integrated into  $Y$ -bus matrix where the vector of bus voltages,  $V_{BUS}$  can be obtained as follows:

$$V_{BUS} = Z_{MATRIX} I_G \quad (4)$$

where  $I_G$  and  $Z_{MATRIX}$  are the bus current injection vector and impedance matrix including the effects of the equivalent impedance, respectively.

By using the superposition law, the voltage contribution of each generator to each bus can be obtained as follows:

$$\begin{bmatrix} \Delta v_1^n \\ \vdots \\ \Delta v_n^n \\ \vdots \\ \Delta v_N^n \end{bmatrix} = \begin{bmatrix} z_{11} & \cdots & z_{1n} & \cdots & z_{1N} \\ \vdots & \ddots & \vdots & \ddots & \vdots \\ z_{n1} & \cdots & z_{nn} & \cdots & z_{nN} \\ \vdots & \ddots & \vdots & \ddots & \vdots \\ z_{N1} & \cdots & z_{Nn} & \cdots & z_{NN} \end{bmatrix} \quad (5)$$

where the effect of each current injection into the system is taken one by one. From (5), voltage at bus  $i$  contributed by generator bus  $n$  ( $\Delta v_i^n$ ) and the voltage of bus  $i$  contributed by all generator buses can be written as follow:

$$\Delta v_i^n = z_{in} I_{n,G} \quad (6)$$

$$V_i = \sum_{n=1}^{N_G} \Delta v_i^n \quad (7)$$

The next step is tracing the current in the system. By referring to Fig. 1, the line current from bus  $i$  to bus  $j$ ,  $\Delta i_{ij}^n$  and from bus  $j$  to bus  $i$ ,  $\Delta i_{ji}^n$  which are corresponding to the voltage contribution of generator bus  $n$ , can be obtained using the following equations:

$$\Delta i_{ij}^n = (\Delta v_i^n - \Delta v_j^n) * (g_{ij} + jb_{ij}) + (jc / 2) * \Delta v_i^n \quad (8)$$

$$\Delta i_{ji}^n = (\Delta v_i^n - \Delta v_j^n) * (g_{ij} + jb_{ij}) + (jc / 2) * \Delta v_j^n \quad (9)$$

where  $(g_{ij} + jb_{ij})$  is the line admittance from bus  $i$  to  $j$  and  $c/2$  is the line charging susceptance.

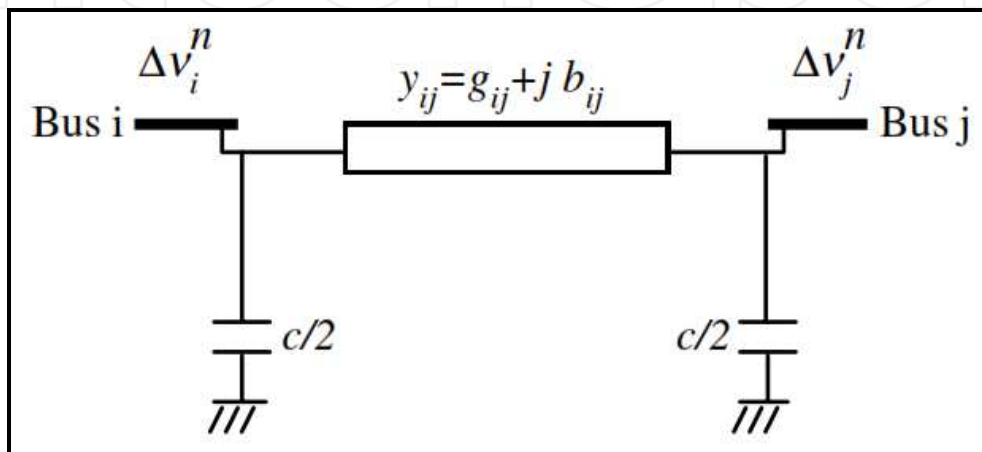

Fig. 1.  $\pi$ -model of transmission line

By referring to (Teng, 2005), the bus voltage can be considered as the force or pressure, which is pushing the current contributed by different generators through the line. Therefore, with a proper manipulation, the power flow contributed by the generator bus  $n$  and total power flow can be calculated as follow:

$$\Delta s_{ij}^n = (\Delta v_1^1 + \dots + \Delta v_i^n + \dots + \Delta v_i^{N_G}) (\Delta i_{ij}^n)^* = V_i (\Delta i_{ij}^n)^* \quad (10)$$

$$S_{ij} = \sum_{n=1}^{N_G} \Delta s_{ij}^n \quad (11)$$

where  $\Delta s_{ij}^n$  is the line power flow produced by generator bus  $n$  from bus  $i$  to bus  $j$ .

To obtain the contribution of individual generator to loads, the same procedure is applied. The current injection from generator  $n$  into load bus  $i$ ,  $\Delta i_{i,L}^n$  and the total current injection,  $I_{i,L}$  can be calculated as follow:

$$\Delta i_{i,L}^n = \frac{\Delta v_i^n}{Z_{i,L}} \quad (12)$$

$$I_{i,L} = \sum_{n=1}^{N_G} \Delta i_{i,L}^n \quad (13)$$

Since the voltage and current contributions of individual generator have been identified, the power of load bus  $i$  contributed by generator bus  $n$ ,  $\Delta s_{i,L}^n$  and the total power of load bus,  $S_{i,L}$  can be accounted as follow:

$$\Delta s_{i,L}^n = V_i \left( \Delta i_{i,L}^n \right)^* \quad (14)$$

$$S_{i,L} = \sum_{n=1}^{N_G} \Delta s_{i,L}^n \quad (15)$$

Vector  $\Delta s_{i,L}^n$  is used as a target in the training process of proposed hybrid GA-SVM technique.

### 3. Function estimation using LS-SVM

Support vector machine (SVM) is known as a powerful methodology for solving problems in nonlinear classification, function estimation and density estimation. SVM has been introduced within the context of statistical learning theory and structural risk minimization. Least squares support vector machine (LS-SVM) is reformulations from standard SVM (Vapnik, 1995) which lead to solving linear Karush-Kuhn-Tucker (KKT) systems. LS-SVM is closely related to regularization networks and Gaussian processes but additionally emphasizes and exploits primal-dual interpretations (Espinoza et al., 2006).

In LS-SVM function estimation, the standard framework is based on a primal-dual formulation. Given  $N$  dataset  $\{x_i, y_i\}_{i=1}^N$ , the goal is to estimate a model of the form:

$$y(x) = w^T \varphi(x) + b + e_i \quad (16)$$

where  $x \in R^n, y \in R$  and  $\varphi(\cdot): R^n \rightarrow R^{n_h}$  is a mapping to a high dimensional feature space. The following optimization problem is formulated (Suykens et al., 2002):

$$\min_{w,b,e} J(w,e) = \frac{1}{2} w^T w + \gamma \frac{1}{2} \sum_{i=1}^N e_i^2 \quad (17)$$

$$\text{such that } y_i = w^T \varphi(x_i) + b + e_i, i=1, \dots, N.$$

With the application of Mercer's theorem (Vapnik, 1995) for the kernel matrix  $\Omega$  as  $\Omega_{ij} = K(x_i, x_j) = \varphi(x_i)^T \varphi(x_j)$ ,  $i, j=1, \dots, N$ , it is not required to compute explicitly the nonlinear mapping  $\varphi(\cdot)$  as this is done implicitly through the use of positive definite kernel functions  $K$  (Espinoza et al., 2006). From the Lagrange function (Suykens et al., 2002):

$$\zeta(w,b,e;\beta) = \frac{1}{2} w^T w + \gamma \frac{1}{2} \sum_{i=1}^N e_i^2 - \sum_{i=1}^N \beta_i (w^T \varphi(x_i) + b + e_i - y_i) \quad (18)$$

where  $\beta_i$  are Lagrange multipliers. Differentiating (18) with  $w, b, e_i$  and  $\beta_i$ , the conditions for optimality can be described as follow (Suykens et al., 2002):

$$\left\{ \begin{array}{l} \frac{d\zeta}{dw} = 0 \rightarrow w = \sum_{i=1}^N \beta_i \phi(x_i) \\ \frac{d\zeta}{db} = 0 \rightarrow \sum_{i=1}^N \beta_i = 0 \\ \frac{d\zeta}{de_i} = 0 \rightarrow \beta_i = \gamma e_i, i = 1, \dots, N \\ \frac{d\zeta}{d\beta_i} = 0 \rightarrow y_i = w^T \phi(x_i) + b + e_i, i = 1, \dots, N \end{array} \right. \quad (19)$$

By elimination of  $w$  and  $e_i$ , the following linear system is obtained (Suykens et al., 2002):

$$\left[ \begin{array}{c|c} 0 & 1^T \\ y & \Omega + \gamma^{-1}I \end{array} \right] \left[ \begin{array}{c} b \\ \beta \end{array} \right] = \left[ \begin{array}{c} 0 \\ y \end{array} \right] \quad (20)$$

with  $y = [y_1, \dots, y_N]^T$ ,  $\beta = [\beta_1, \dots, \beta_N]^T$ . The resulting LS-SVM model in dual space becomes:

$$y(x) = \sum_{i=1}^N \beta_i K(x, x_i) + b \quad (21)$$

Usually, the training of the LS-SVM model involves an optimal selection of kernel parameters and regularization parameter. For this paper, the RBF Kernel is used which is expressed as:

$$K(x, x_i) = e^{-\frac{\|x-x_i\|^2}{2\sigma^2}} \quad (22)$$

Note that  $\sigma^2$  is a parameter associated with RBF function which has to be tuned. There is no doubt that the efficient performance of LS-SVM model involves an optimal selection of kernel parameter,  $\sigma^2$  and regularization parameter,  $\gamma$ . In (Espinoza et al., 2007), these parameters selection are tuned via cross-validation technique. Even though this technique seemed to be simple, the forecasting performance by using this technique is at average accuracy (Lean et al., 2009). Thus by using GA as an optimizer, a more accurate result is expected. In addition, GA is known as a powerful stochastic search and optimization technique. The hybridization of GA and LS-SVM should give better accuracy and good generalization, especially in real and reactive power tracing problem.

#### 4. Genetic algorithm

Genetic Algorithm (GA) is known as a subset of evolutionary algorithms that model biological processes which is influenced by the environmental factor to solve various numerical optimization problems. GA allows a population composed of many individuals or called chromosomes to evolve under specified rules to a state that maximizes the fitness or minimizes the cost functions. Traditionally, GA is utilizing binary numbers as a representation, but the using of floating and real numbers as representation are becoming popular lately. This paper will focus on the technique that using floating numbers which has been developed by (R. L & S. A. Haupt, 1998).

If the chromosome has  $N_{par}$  parameters (an  $N$ -dimensional optimization problem) given by  $p_1, p_2, \dots, p_{N_{par}}$ , then the single chromosome is written as an array with  $1 \times N_{par}$  elements as follows:

$$chromosome = [p_1, p_2, p_3, \dots, p_{N_{par}}] \quad (23)$$

GA does not work with a single string but with a population of strings, which evolves iteratively by generating new individuals taking the place of their parents. Normally, the initial population is generated at random. The performance of each string is evaluated according to its fitness. Fitness is used to provide a measure of how individuals have performed in the problem domain. The choice of objective and fitness function is proposed in the next section.

With an initial population of individuals and evaluated through its fitness, the operators of GA begin to generate a new and improved population from the old one. A simple GA consists of three basic operations: selection, crossover and mutation. Selection determines which individuals are chosen for crossover and a process in which individual chromosomes are copied according to their fitness. Parents are selected according to their fitness performance and this can be done through several methods. For this paper, *roulette wheel* selection method is used (Goldberg, 1989).

Crossover is a process after the parents chromosomes are selected from *roulette wheel* method. It is a process that each individual will exchange information to create new structure of chromosome called offspring. It begins by randomly selecting a parameter in the first pair of parents to be crossover at point:

$$\alpha = round\{random * N_{par}\} \quad (24)$$

Let

$$parent_1 = [p_{m1}, \dots, p_{m\alpha}, \dots, p_{mN_{par}}] \quad (25)$$

$$parent_2 = [p_{d1}, \dots, p_{d\alpha}, \dots, p_{dN_{par}}] \quad (26)$$

where  $m$  and  $d$  subscripts discriminate between the *mom* and *dad* parent. Then the selected parameters are combined to form new parameters that will appear in the offspring, as follow:

$$p_{new1} = p_{m\alpha} - \beta[p_{m\alpha} - p_{d\alpha}] \quad (27)$$

$$p_{new2} = p_{d\alpha} + \beta[p_{m\alpha} - p_{d\alpha}] \quad (28)$$

where  $\beta$  is also a random value between 0 and 1. In this paper, small modification of extrapolation and crossover methods which has been proposed in (R. L & S. A. Haupt, 1998) was done in equations (29) and (30) to obtain the offsprings, as follow (Sulaiman et al., 2010):

$$offspring_1 = [p_{m1}, \dots, p_{new1}, \dots, p_{mN_{par}}] \quad (29)$$



$$offspring_2 = [p_{d1}, \dots, p_{new2}, \dots, p_{dNpar}] \quad (30)$$

Although selection and crossover are applied to chromosome in each generation to obtain a new set for better solutions, occasionally they may become overzealous and lose some useful information. To protect these irrecoverable loss or premature convergence occur, mutation is applied. Mutation is random alteration of parameters with small probability called probability of mutation (0-10%). Multiplying the mutation rate by the total number of parameters gives the number of parameters that should be mutated. Next, random numbers are chosen to select of the row and columns of the parameters to be mutated. A mutated parameter is replaced by a new random parameter.

### 5. GA-SVM for power tracing

In LS-SVM function estimation, the standard framework is based on a primal-dual formulation as explained in section 3. Usually, the training of the LS-SVM model involves an optimal selection of kernel parameters and regularization parameter. In order to find the optimal value of regularization parameter,  $\gamma$  and Kernel RBF parameter,  $\sigma^2$ , the hybrid genetic algorithm (GA) with LS-SVM is proposed. Each chromosome consists of two parameters representing  $\gamma$  and  $\sigma^2$  in continuous floating numbers that generated randomly. Then each variable are concatenated to construct multivariable string. Fig. 2 shows the example of the chromosome which is can be said as the candidate for solution; for this case is  $\gamma$  and  $\sigma^2$ . The main objective is to find the best combination of these two variables that will produces good generalization of LS-SVM model. The evaluation process is done by using these values in LS-SVM model for training and testing to obtain the mean squares error (MSE) between the output and the target that have been created. The objective function is the value of MSE to be minimized,  $H$  as follows:

$$H = \min(MSE) \quad (31)$$

After evaluating each chromosome, the objective function in equation (31) is transformed and normalized to a fitness scheme to be maximized as follows:

$$f = \frac{1}{1 + H} \quad (32)$$

The GA properties to find the optimal  $\gamma$  and  $\sigma^2$  are as follow:

- Selection: roulette wheel
- Crossover probability = 0.9
- Mutation probability = 0.1
- Population = 20
- Maximum iteration = 30

The proposed tracing method is elaborated by designing an appropriate GA-SVM model using LS-SVMlab Toolbox (Pelkmans et al., 2002) for the modified IEEE 14-bus system as shown in Fig. 3. This system consists of 14 buses and 20 transmission lines. The modification has been made for this test system. Initially, the synchronous condenser at bus 3, 4 and 5 are only supporting the reactive power supply for the system. For this case, these synchronous

condensers are treated and work as normal generators to alleviate the real power support at generator bus 1. In addition, the modification is made to see the performance of design GA-SVM model for the system with more than two generators. The input samples for training is assembled using daily load curve and performing load flow analysis for every hour of load demand using MATPOWER software package (Zimmerman et al., 2011). Daily load curves for every bus for real and reactive power are shown in Figs. 4 and 5 respectively. Input data and target data for real and reactive power allocation problem for GA-SVM model are tabulated in Table 1. The flow of GA-SVM is depicted in Fig. 6.

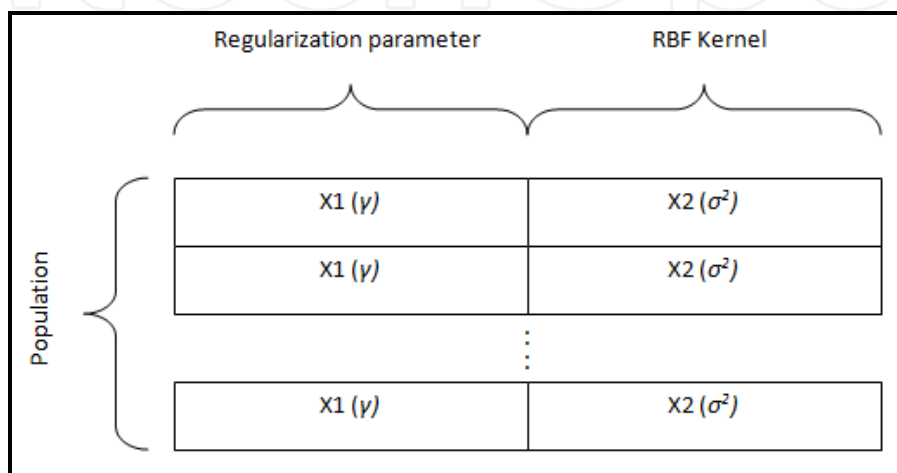

Fig. 2. Chromosome for solution

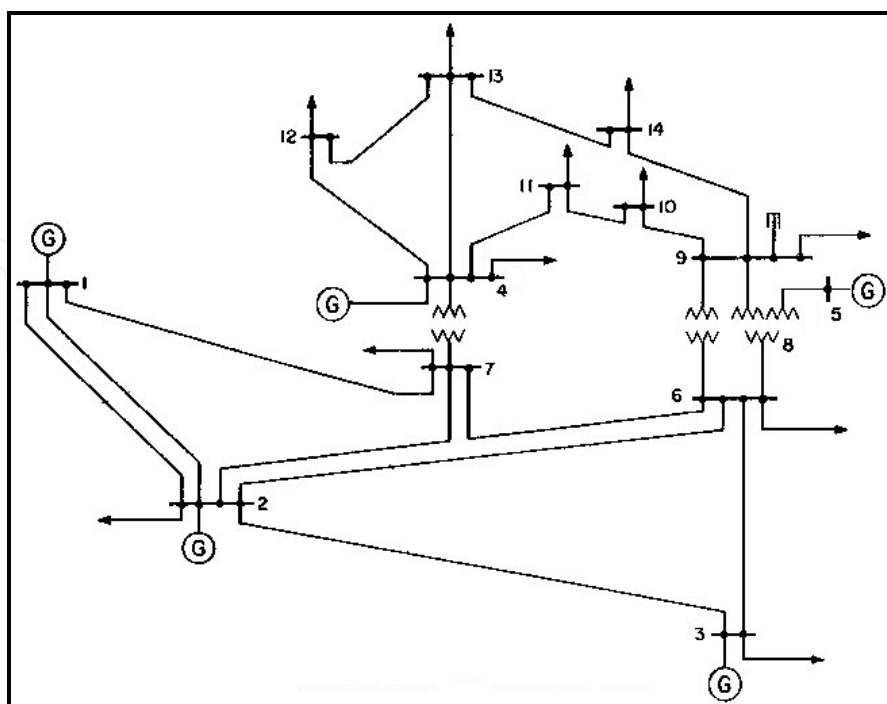

Fig. 3. Modified IEEE-14 bus system

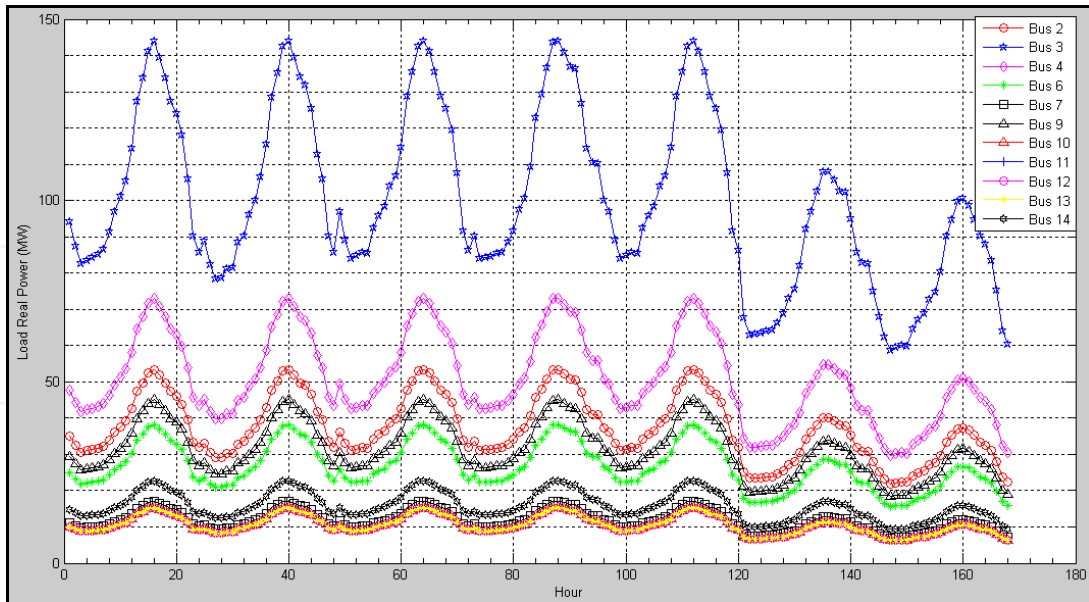

Fig. 4. Daily load curve for real power

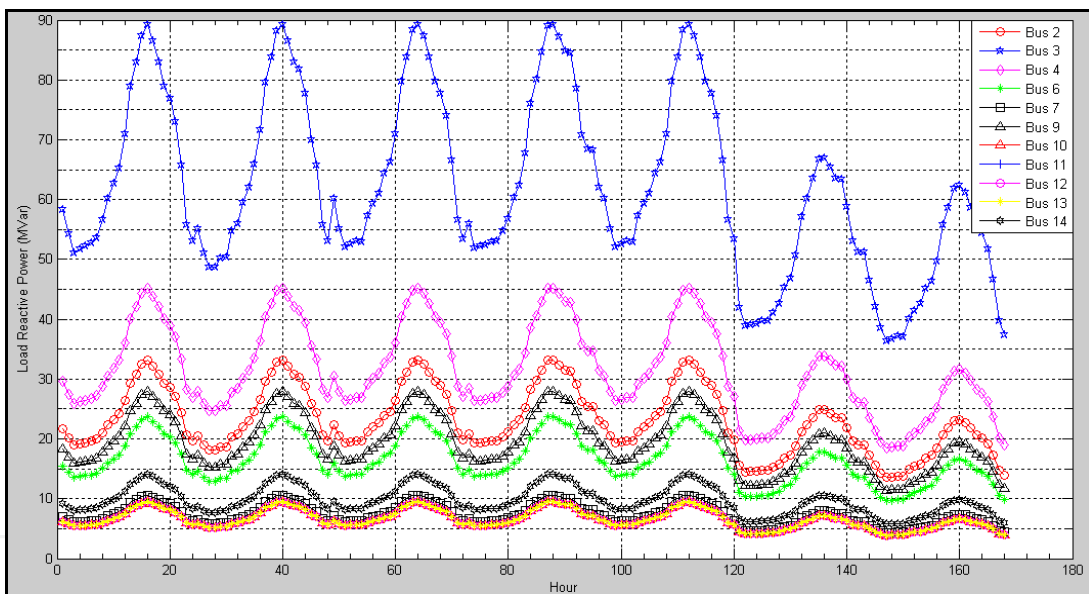

Fig. 5. Daily load curve for reactive power

Input and Output	Description
$I_1$ to $I_{11}$	Real load demand ( $Pd_2, Pd_3, Pd_4, Pd_6, Pd_7, Pd_9, Pd_{10}, Pd_{11}, Pd_{12}, Pd_{13}, Pd_{14}$ )
$I_{12}$ to $I_{22}$	Reactive load demand ( $Qd_2, Qd_3, Qd_4, Qd_6, Qd_7, Qd_9, Qd_{10}, Qd_{11}, Qd_{12}, Qd_{13}, Qd_{14}$ )
$I_{23}$ to $I_{26}$	Scheduled real power generation ( $P_{G2}$ to $P_{G5}$ )
$O_1$ to $O_{140}$	5 generators' contributions to all buses

Table 1. Description of inputs and outputs of the GA-SVM model

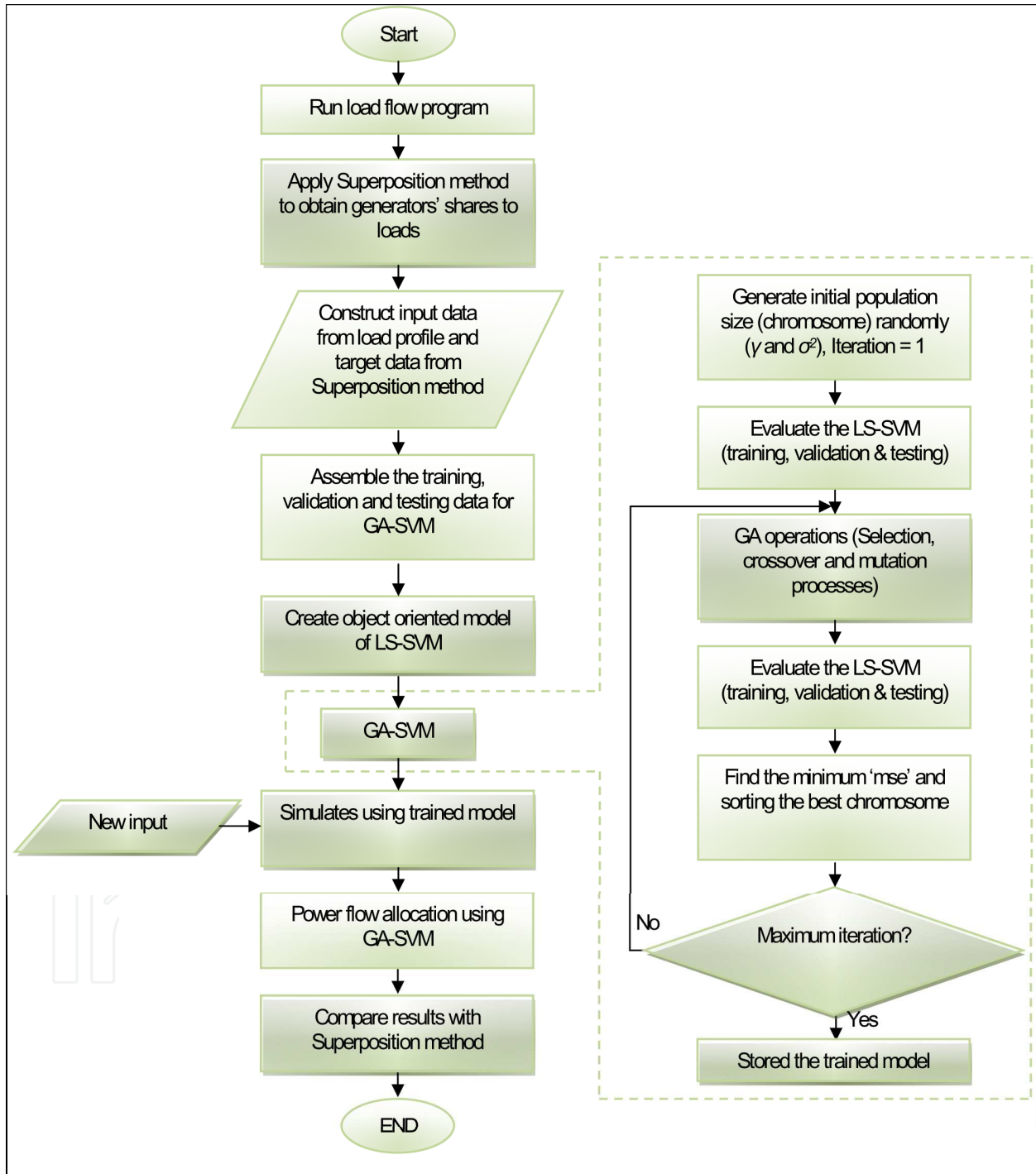

Fig. 6. Flow of proposed GA-SVM

## 6. Results and discussion

### 6.1 Training, validation and testing processes

After the input and target of training data have been created, the next step is to divide the data (D and T) up to training, validation and testing subsets. In this case, one week of load profiles data is used for these processes. 48 samples of data (Monday and Sunday) are used for the training, 72 samples (Tuesday, Wednesday and Saturday) for validation and 48 samples (Thursday and Friday) for testing out of one week (168 hours).

The values of regularization parameter,  $\gamma$  and RBF Kernel,  $\sigma^2$  are decided through the hybrid GA-SVM model that has been discussed previously. From the simulation of GA-SVM model, the final value  $\gamma$  of is set to 913.7632 and  $\sigma^2$  is set to 9.9813 yields reasonable accuracy of the output of the predictive model that has been designed. The mean square error (MSE) for validation is  $3.8322 \times 10^{-5}$  and for validation is  $5.3981 \times 10^{-5}$  which shows that the estimation process by GA-SVM model is successful. The mean squares error (MSE) versus iteration for GA-SVM model is shown in Fig. 7.

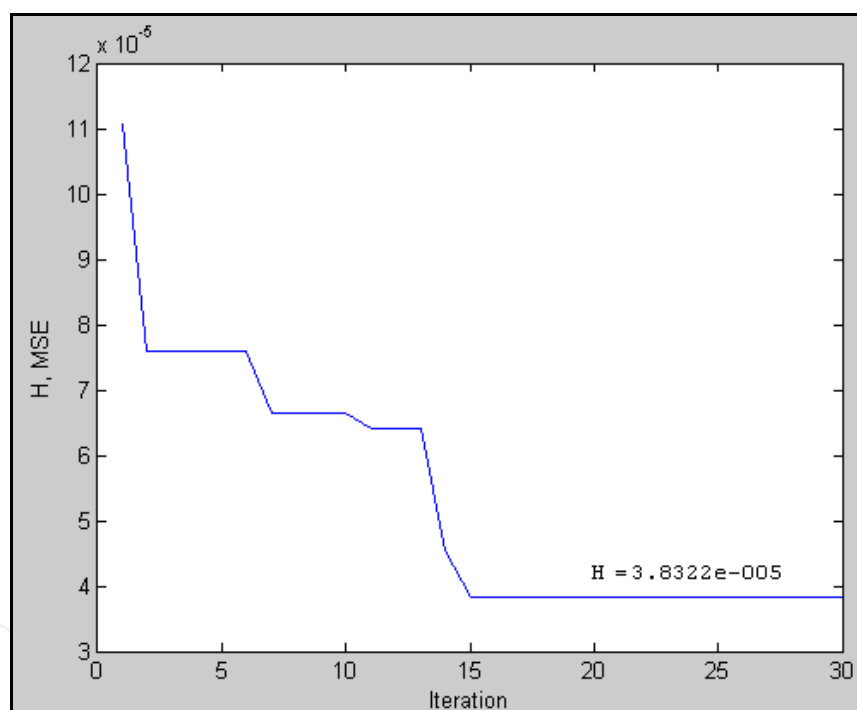

Fig. 7. MSE versus Iteration

### 6.2 Pre-testing

Once the GA-SVM model has been trained in MATLAB based, the pre-testing process is done where the entire sample of data is used to simulate the model. The obtained result from the trained model then is evaluated with the linear regression analysis. The regression analysis that refers to Generator 2 to real load bus 10 is shown in Fig. 8. The correlation coefficient, (R) for this particular real power allocation is equal to one indicates the perfect correlation between trained GA-SVM with Superposition method results. The MSE value for pre-testing is  $4.5401 \times 10^{-5}$ .

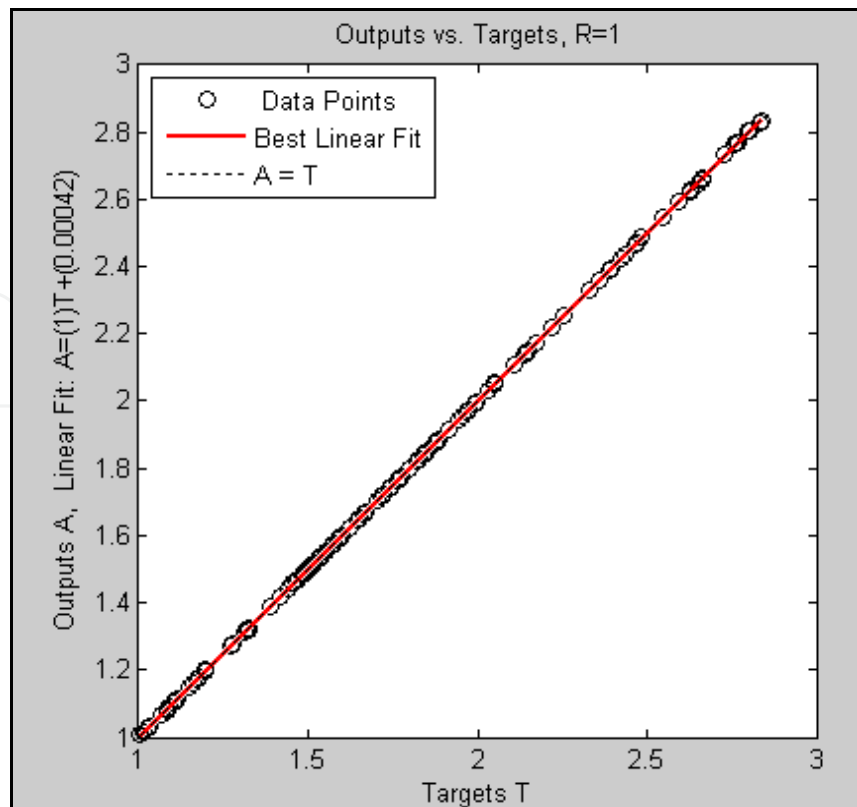

Fig. 8. Regression analysis between hybrid GA-SVM output and corresponding target

### 6.3 Simulation

The case scenario is that real and reactive power at each load is assumed to increase by 10% from hours 1 to 12 and 20 to 24; and to decrease 15% from hours 13 to 19 from the nominal trained pattern. This also assumed that all generators increase and decrease their production proportionally according to the variation of demands. This simulation aims to observe the effect of increment and decrement of the schedule in load demands. Figs. 9 and 10 show the results of generators' shares at load bus 2 for real and reactive power respectively within 24 hours. The GA-SVM output is indicated by solid lines while the Superposition method is indicated by the points 'o'. From this result, it can be observed that the GA-SVM model can allocate the power flow from individual generators to loads with the same pattern of Superposition method's output.

Contributions of real and reactive power from individual generators to loads on hours 14 out of 24 hours using proposed GA-SVM model and Superposition method are tabulated in Tables 2 and 3 respectively. The results obtained by GA-SVM are compared well with the results from Superposition method. The largest discrepancy between generators' share of real and reactive power allocation using GA-SVM and Superposition method are 0.0232 MW at load bus 3 for generator 1 and 0.0187 MVar at load bus 3 for generator 3 respectively. It can be seen that the results obtained utilizing GA-SVM was in conformity with the actual load demand from load flow study although there were small variations in the predicted results. However, the prediction of GA-SVM model was successful since it ables to allocate the ouput of power allocation for new input data with more that 99% accuracy.

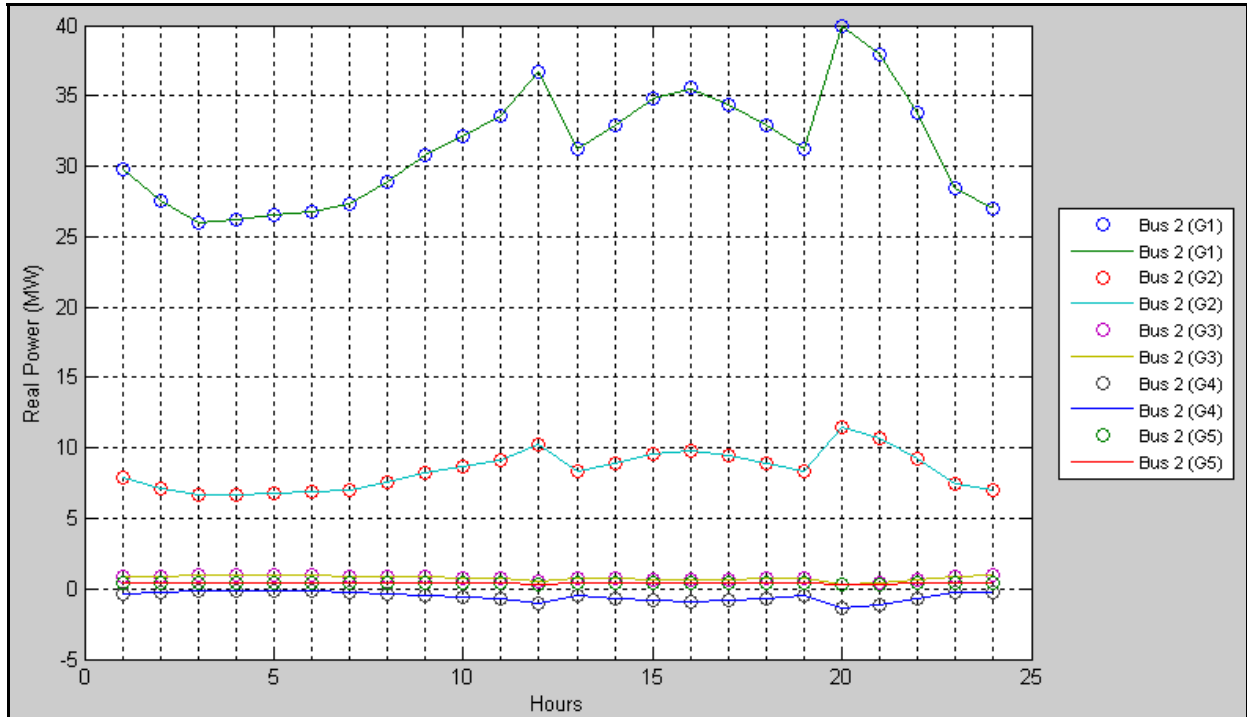

Fig. 9. Real power flow allocation from individual generators to load bus 2 within 24 hours using GA-SVM and Superposition method

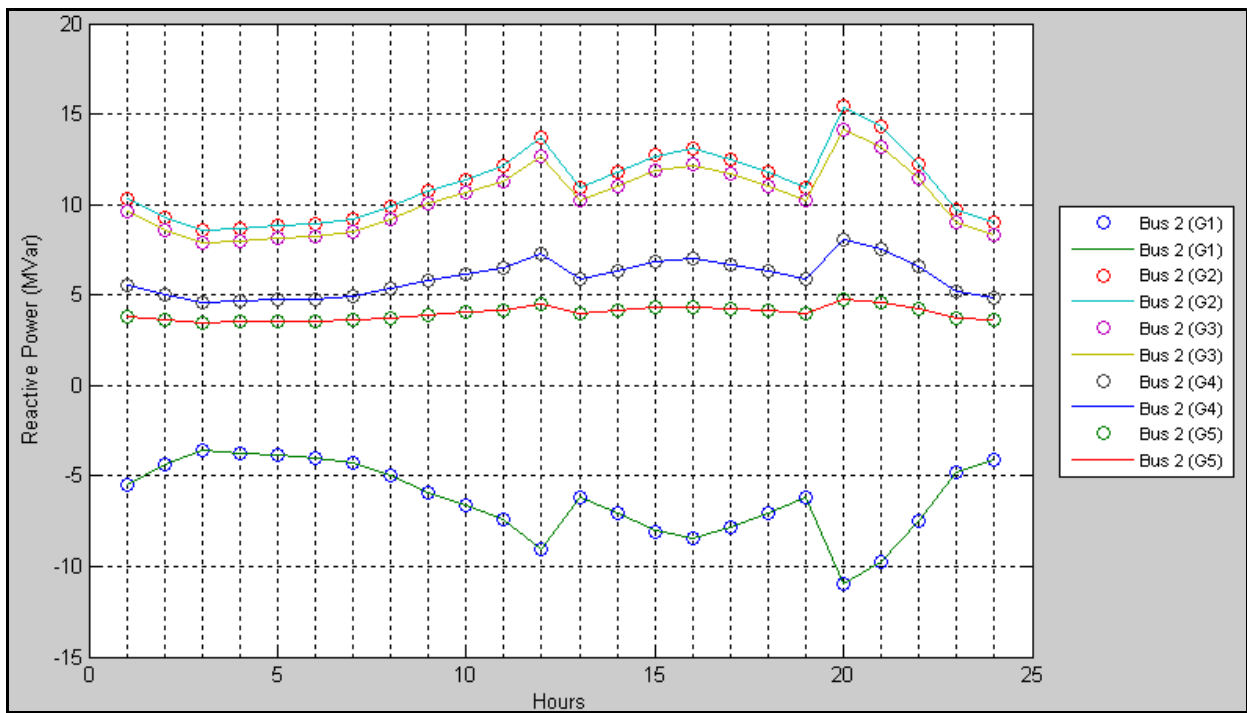

Fig. 10. Reactive power flow allocation from individual generators to load bus 2 within 24 hours using GA-SVM and Superposition method

Bus\Gen	G1		G2		G3		G4		G5		Total		From loadflow	
	P	Q	P	Q	P	Q	P	Q	P	Q	P	Q	P	Q
1	0.0	0.0	0.0	0.0	0.0	0.0	0.0	0.0	0.0	0.0	0.0	0.0	0.0	0.0
2	32.9	-7.1	8.9	11.8	0.7	11.0	-0.7	6.3	0.4	4.1	42.3	26.2	42.3	26.2
3	78.9	-18.5	21.4	27.7	12.0	34.4	-0.4	16.4	2.0	10.6	113.9	70.6	113.9	70.6
4	9.2	-2.0	2.3	3.2	0.4	3.2	1.2	2.7	0.5	1.3	13.5	8.4	13.5	8.4
5	0.0	0.0	0.0	0.0	0.0	0.0	0.0	0.0	0.0	0.0	0.0	0.0	0.0	0.0
6	42.6	-9.9	11.2	14.9	2.3	15.2	0.2	9.4	1.5	6.2	57.8	35.8	57.8	35.8
7	22.8	-5.2	5.8	7.9	0.9	7.8	0.1	5.1	0.6	3.2	30.2	18.7	30.2	18.7
8	0.0	0.0	0.0	0.0	0.0	0.0	0.0	0.0	0.0	0.0	0.0	0.0	0.0	0.0
9	24.9	-5.4	6.3	8.7	1.1	8.8	1.3	5.9	2.1	4.0	35.7	22.1	35.7	22.1
10	8.4	-1.8	2.1	2.9	0.4	3.0	0.6	2.1	0.6	1.3	12.1	7.5	12.1	7.5
11	8.3	-1.8	2.1	2.9	0.3	2.9	0.8	2.2	0.5	1.3	12.1	7.5	12.1	7.5
12	8.2	-1.8	2.1	2.9	0.3	2.9	1.0	2.4	0.4	1.2	12.1	7.5	12.1	7.5
13	8.2	-1.8	2.1	2.9	0.3	2.9	1.0	2.3	0.5	1.2	12.1	7.5	12.1	7.5
14	12.4	-2.7	3.2	4.4	0.5	4.4	1.0	3.2	0.9	1.9	18.0	11.2	18.0	11.2

Table 2. Analysis of generators' contributions to loads on hours 14 using GA-SVM in MW and Mvar

Bus\Gen	G1		G2		G3		G4		G5		Total		From load flow	
	P	Q	P	Q	P	Q	P	Q	P	Q	P	Q	P	Q
1	0.0	0.0	0.0	0.0	0.0	0.0	0.0	0.0	0.0	0.0	0.0	0.0	0.0	0.0
2	32.9	-7.1	8.9	11.8	0.7	11.0	-0.7	6.3	0.4	4.1	42.3	26.2	42.3	26.2
3	78.9	-18.5	21.4	27.7	12.0	34.4	-0.4	16.4	2.0	10.6	113.9	70.6	113.9	70.6
4	9.2	-2.0	2.3	3.2	0.4	3.2	1.2	2.7	0.5	1.3	13.5	8.4	13.5	8.4
5	0.0	0.0	0.0	0.0	0.0	0.0	0.0	0.0	0.0	0.0	0.0	0.0	0.0	0.0
6	42.6	-9.8	11.1	14.9	2.3	15.2	0.2	9.4	1.5	6.2	57.8	35.8	57.8	35.8
7	22.7	-5.2	5.8	7.9	0.9	7.8	0.1	5.1	0.6	3.1	30.2	18.7	30.2	18.7
8	0.0	0.0	0.0	0.0	0.0	0.0	0.0	0.0	0.0	0.0	0.0	0.0	0.0	0.0
9	24.9	-5.4	6.3	8.7	1.1	8.8	1.3	5.9	2.1	4.0	35.7	22.1	35.7	22.1
10	8.4	-1.8	2.1	2.9	0.4	3.0	0.6	2.1	0.6	1.3	12.1	7.5	12.1	7.5
11	8.3	-1.8	2.1	2.9	0.3	2.9	0.8	2.2	0.5	1.3	12.1	7.5	12.1	7.5
12	8.2	-1.8	2.1	2.9	0.3	2.9	1.0	2.4	0.4	1.2	12.1	7.5	12.1	7.5
13	8.2	-1.8	2.1	2.9	0.3	2.9	1.0	2.3	0.5	1.2	12.1	7.5	12.1	7.5
14	12.4	-2.7	3.2	4.4	0.5	4.4	1.0	3.2	0.9	1.9	18.0	11.2	18.0	11.2

Table 3. Analysis of generators' contributions to loads on hours 14 using Superposition method in MW and MVar



In addition, the GA-SVM model computes the results within 750 ms whereas the Superposition method took about 15 seconds to calculate the same real and reactive power allocation in this simulation process. It would be worth to highlight that better computation time is crucial to improve the online application. For that, the GA-SVM provides the results in a faster manner with good accuracy.

## 7. Conclusion

The effectiveness of GA in determining the optimal values of hyper-parameters of LS-SVM to solve power tracing problem has been discussed in this paper. The developed hybrid GA-SVM adopts real and reactive power tracing output determined by Superposition method as an estimator to train the model. The results show that GA-SVM gives good accuracy in predicting the generators' output and compared well with Superposition method and load flow study. It is worth to highlight the proposed GA-SVM possesses the following feature:

- The proposed method adopted Superposition method which based on well-known circuit theories as a teacher in training, validating and testing processes.
- Power contributed by each generator may have positive and negative values indicate the direction of the power at load.
- Since the Superposition method is used as a teacher, the tracing method can be utilized in circular or loop flow system.
- The integration of GA and LS-SVM is straight forward and simple by utilizing the toolbox.
- The proposed method provides the results in a faster manner with good accuracy.

The proposed hybrid method can be utilized as generation forecasting management since the power produced by each generator has been traced and identified. Thus the transmission congestion problem can be easily avoided by proper generation scheduling which can be proposed and studied in the future works.

## 8. Acknowledgment

The authors wish to acknowledge the Ministry of Higher Education (MOHE), Malaysia and Universiti Teknologi Malaysia (UTM) for the funding of this project.

## 9. References

- Bialek, J., & Tam, D. B. (1996). Tracing the generators' output. *Proceeding of International Conference on Opportunities and Advances in International Electric Power Generation*, pp. 133-136, March 19-20, 1996
- Espinoza, M.; Suykens, J.; & Moor, B. (2006). Fixed-size Least Squares Support Vector Machines: A Large Scale Application in Electrical Load Forecasting. *Computational Management Science*, Vol. 3, No. 2, pp. 113-129
- Espinoza, M.; Suykens, J. A. K.; Belmans, R.; & De Moor, B. (2007). Electric Load Forecasting. *IEEE Control Systems Magazine*, Vol. 27, No. 5, pp. 43-57. ISSN 1066-033X

- Goldberg, D. E. (1989). *Genetic algorithms in search, optimization, and machine learning*. Addison-Wesley, ISBN 0-201-15767-5, Reading, Mass
- Haupt, R. L., & Haupt, S. E. (1998). *Practical genetic algorithms*. Wiley Pub, ISBN 0-471-45565-2, New York
- Lean, Y.; Huanhuan, C.; Shouyang, W.; & Kin Keung, L. (2009). Evolving Least Squares Support Vector Machines for Stock Market Trend Mining. *IEEE Transactions on Evolutionary Computation*, Vol. 13, No. 1, pp. 87-102. ISSN 1089-778X
- Lo, K. L., & Alturki, Y. A. (2006). Towards reactive power markets. Part 1: reactive power allocation. *IEE Proceedings-Generation, Transmission and Distribution*, Vol. 153, No. 1, pp. 59-70. ISSN 1350-2360
- Mustafa, M. W., Khalid, S. N., Shareef, H., & Khairuddin, A. (2008a). A new method for real power transfer allocation using modified nodal equations. *Proceeding of IEEE 2nd International Power and Energy Conference (PECon 2008)*, Johor Bahru, Malaysia. December 1-3, 2008
- Mustafa, M. W., Khalid, S. N., Shareef, H., & Khairuddin, A. (2008b). Reactive power transfer allocation method with the application of artificial neural network. *IET Generation, Transmission & Distribution*, Vol. 2, No. 3, pp. 402-413. ISSN 1751-8687
- Mustafa, M. W., Sulaiman, M. H., Shareef, H., & Khalid, S. N. A. (2011). Transmission Loss Allocation in Deregulated Power System Using Hybrid Genetic Algorithm-Support Vector Machine Technique. *Cyber Journals: Multidisciplinary Journal in Science and Technology, Journal of Selected Areas in Renewable and Sustainable Energy (JRSE), January Edition*, pp. 10-19. ISSN 1925-2676
- Pantos, M., Verbic, G., & Gubina, F. (2005). Modified topological generation and load distribution factors. *IEEE Transactions on Power Systems*, Vol. 20, No. 4, pp. 1998-2005. ISSN 0885-8950
- Pelkmans, K.; Suykens, J. A. K.; Gestel, T. V.; Brabanter, J. D.; Lukas, L. & Hamers, B. (2002). *LS-SVMLab: A Matlab/C Toolbox for Least Squares Support Vector Machines*. Leuven, Belgium: ESAT-SISTA, K. U. Leuven. Available from <http://www.esat.kuleuven.be/sista/lssvmlab/>
- Sulaiman, M. H.; Aliman, O. & Rahim, S. R. A. (2010). Optimal embedded generation allocation in distribution system employing real coded genetic algorithm. *Proceeding of International Conference on Power Systems Engineering (ICPSE 2010)*, pp. 591-596, ISSN 1307-6892, Penang, Malaysia. February 24-26, 2010
- Sulaiman, M. H., Mustafa, M. W., & Aliman, O. (2008). Power flow and loss tracing in deregulated transmission system using proportional tree method. *International Review of Electrical Engineering (IREE)*, Vol. 3, No. 4, pp. 691-698. ISSN 1827-6660
- Suykens, J. A. K.; Gestel, T. V.; Brabanter, J. D.; Moor, B. D.; & Vandewelle, J. (2002). *Least Squares Support Vector Machines*. World Scientific, ISBN 981-238-151-1, Singapore
- Teng, J.-H. (2005). Power flow and loss allocation for deregulated transmission systems. *International Journal of Electrical Power & Energy Systems*, Vol. 27, No. 4, pp. 327-333. ISSN 0142-0615

- Vapnik, V. N. (1995). *The Nature of Statistical Learning Theory 2nd ed.* Springer-Verlag, ISBN 0-387-98780-0, New York
- Wen-Chen, C., Bin-Kwie, C., & Chung-Hsien, L. (2004). Allocating the costs of reactive power purchased in an ancillary service market by modified Y-bus matrix method. *IEEE Transactions on Power Systems*, Vol. 19, Np. 1, pp. 174-179. ISSN 0885-8950
- Wu, F. F., Yixin, N., & Ping, W. (2000). Power transfer allocation for open access using graph theory-fundamentals and applications in systems without loopflow. *IEEE Transactions on Power Systems*, Vol. 15, No. 3, pp.923-929. ISSN 0885-8950
- Zimmerman, R. D.; Murillo Sanchez, C. E. & Thomas, R. J. (2011). MATPOWER: Steady-State Operations, Planning, and Analysis Tools for Power Systems Research and Education. *IEEE Transactions on Power Systems*, Vol 26, No. 1, pp. 12-19. ISSN 0885-8950

IntechOpen

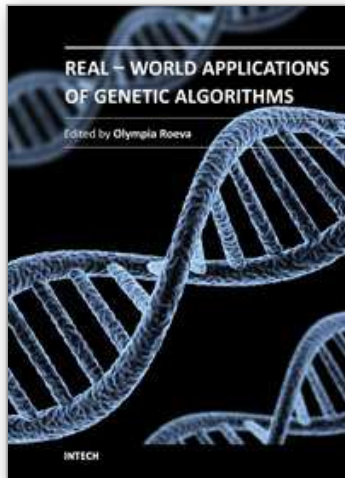

## **Real-World Applications of Genetic Algorithms**

Edited by Dr. Olympia Roeva

ISBN 978-953-51-0146-8

Hard cover, 376 pages

**Publisher** InTech

**Published online** 07, March, 2012

**Published in print edition** March, 2012

The book addresses some of the most recent issues, with the theoretical and methodological aspects, of evolutionary multi-objective optimization problems and the various design challenges using different hybrid intelligent approaches. Multi-objective optimization has been available for about two decades, and its application in real-world problems is continuously increasing. Furthermore, many applications function more effectively using a hybrid systems approach. The book presents hybrid techniques based on Artificial Neural Network, Fuzzy Sets, Automata Theory, other metaheuristic or classical algorithms, etc. The book examines various examples of algorithms in different real-world application domains as graph growing problem, speech synthesis, traveling salesman problem, scheduling problems, antenna design, genes design, modeling of chemical and biochemical processes etc.

### **How to reference**

In order to correctly reference this scholarly work, feel free to copy and paste the following:

Mohd Wazir Mustafa, Mohd Herwan Sulaiman, Saifulnizam Abd. Khalid and Hussain Shareef (2012). Hybrid Genetic Algorithm-Support Vector Machine Technique for Power Tracing in Deregulated Power Systems, Real-World Applications of Genetic Algorithms, Dr. Olympia Roeva (Ed.), ISBN: 978-953-51-0146-8, InTech, Available from: <http://www.intechopen.com/books/real-world-applications-of-genetic-algorithms/hybrid-genetic-algorithm-support-vector-machine-technique-for-power-tracing-in-deregulated-power-sys>

**INTECH**  
open science | open minds

### **InTech Europe**

University Campus STeP Ri  
Slavka Krautzeka 83/A  
51000 Rijeka, Croatia  
Phone: +385 (51) 770 447  
Fax: +385 (51) 686 166  
[www.intechopen.com](http://www.intechopen.com)

### **InTech China**

Unit 405, Office Block, Hotel Equatorial Shanghai  
No.65, Yan An Road (West), Shanghai, 200040, China  
中国上海市延安西路65号上海国际贵都大饭店办公楼405单元  
Phone: +86-21-62489820  
Fax: +86-21-62489821

© 2012 The Author(s). Licensee IntechOpen. This is an open access article distributed under the terms of the [Creative Commons Attribution 3.0 License](#), which permits unrestricted use, distribution, and reproduction in any medium, provided the original work is properly cited.

IntechOpen

IntechOpen