

We are IntechOpen, the world's leading publisher of Open Access books Built by scientists, for scientists

4,800

Open access books available

122,000

International authors and editors

135M

Downloads

Our authors are among the

154

Countries delivered to

TOP 1%

most cited scientists

12.2%

Contributors from top 500 universities



WEB OF SCIENCE™

Selection of our books indexed in the Book Citation Index
in Web of Science™ Core Collection (BKCI)

Interested in publishing with us?
Contact book.department@intechopen.com

Numbers displayed above are based on latest data collected.

For more information visit www.intechopen.com



Seismic Behavior and Retrofit of Infilled Frames

Mohammad Reza Tabeshpour¹, Amir Azad¹ and Ali Akbar Golafshani²

¹*Mechanical Engineering Department,*

²*Civil Engineering Department
Sharif University of Technology, Tehran,
Iran*

1. Introduction

The most important recent earthquakes showed the importance of seismic behavior of various types of structures such as infilled frames: Japan 2011 (Takewaki et al., 2011), Haiti 2010 (Eberhard et al.) and Newzealand 2010 (Ismail et al. 2011). There are many important questions in the field of infilled frames, such as:

1. What are the negative and positive effects of infill walls in various types of buildings (local and global)?
2. Where infills should be considered (in which type of structures, considering lateral resisting system)?
3. When it is better to have interaction between frame and infill? In what type of structures considering the number of stories?
4. When it is better to have a gap between frame and infill?
5. What is the state of the art in this field?
6. Comparing National and international codes, what is the state of the practice?
7. What are the suitable strategies to retrofit existing infilled frames?

The aim of this chapter is to answer some of these questions. A categorized discussion is presented here to classify the problems solved or to be solved.

An ideal model of structure (bare frame) is considered usually in order to analyze and design the structure, which undoubtedly has important differences with its actual model. The actual model has also some differences with the considered model such as effects of infill walls. Existence of the infill walls basically provides higher stiffness and strength for the frames, but their detrimental effects on the structure performance is ignored due to lack of adequate information about the behavior of frames and infill walls. Meanwhile, recent studies have shown that different arrangements of stiffness, mass and strength by each other can have significant effect on structure behavior and their response. One of the most common failure modes of structures in earthquakes is soft story failure which causes by discontinuity of lateral force resisting elements such as braces, shear walls or infill walls in the first story. In this case columns are imposed to large deformation and also plastic hinges are formed at top and bottom of the columns. This case usually is named as story mechanism. Due to eccentricity of the center of mass and stiffness, which causes by asymmetrical arrangement of infill walls, high torsional moment is produced. Other failure mode is short column that is a common mode in concrete structures.

Tabeshpour (2009d) has presented a comparative study of several building codes about masonry infill wall for design purposes. Tabeshpour et al. (2011d) investigated the lateral drift of concrete infilled frames to answer the following question: When and how is it better to separate infill from frame?

2. Masonry infill walls

Regarding to the combined behavior from the infill wall and structural frame which observed in many earthquakes, researchers predicted these events with modeling the masonry infill walls based on Fig. 1 as a compression strut elements. The existence of infill walls can change the structural behavior from flexural action into axial action. The advantages in the conversion of flexural action to axial action are:

- Reduce contribution of frame in lateral resisting;
- Reducing the lateral deformations.

The disadvantages of converting the flexural action to axial action:

- Increase of the axial load in the column and foundation,
- Creation of the concentrated shears at top and bottom of the column,
- Creation concentrated shears at beginning and end of the beam,
- Creation of huge shears on the foundation.

The equivalent struts of infill wall may be modeled in 3 different types: beam-to-beam (Fig. 2), column-to-column (Fig. 3) and node-to-node (Fig. 4). If it take places-to-column model like Fig. 3 then some forces would be exchanged between walls and column. This part of column is known as short column.

Because of significant stiffness and strength of the infill walls, they may cause severe irregularities in stiffness and strength in the building's elevation and plan. Various effects of masonry infill walls are summarized in table 1.

3. The history of modeling

Finite element modeling of masonry infill wall is a very complex and unreliable task due to several parameters such as: mortar characteristics, brick specifications, the interaction between brick and mortar, the interaction between masonry infill wall and frame. Possible discussions on this issue would be:

1. Modeling of infill walls categorized in two methods:
 - Detailed models (Micro)
 - Simple models (Macro)

The former is offered based on the finite element of the masonry infill wall which has utilized common methods in theories of elasticity and plasticity. The behavior of macro models are based on physical behavior of infill walls that can be modeled by using one or some structural elements.

2. The second important issue is related to the capacity of model to cover some/all of the related nonlinear phenomena. For example, actual stiffness in some models are not considered in the elastic limit. Some other models take into account its stiffness and decrease carefully as well as the decline in strength. That is how the structural behavior can be studied before reaching the fracture.
3. Another issue is to study the effects of one directional and cyclic loading on behavior and characteristics of the system.

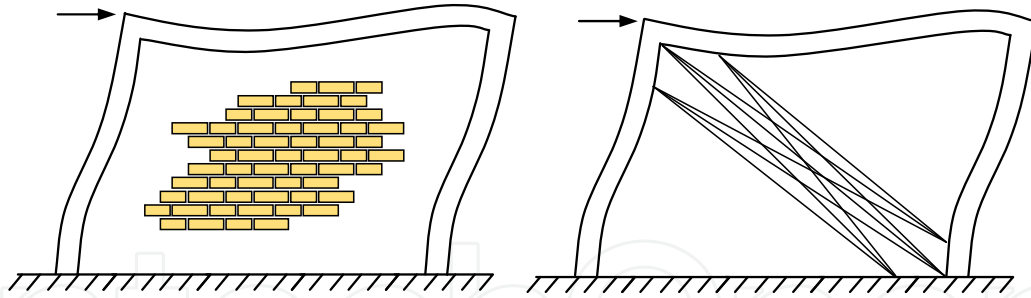

Fig. 1. Model with 9 struts

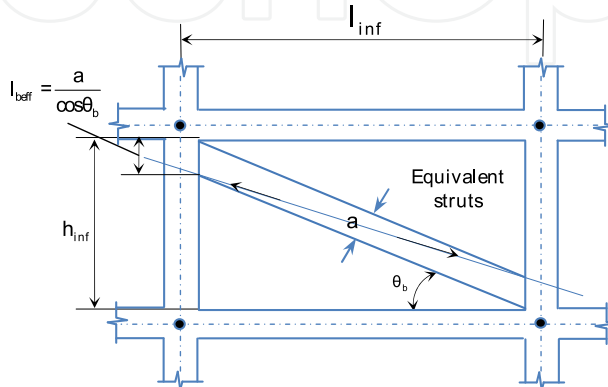

Fig. 2. Beam-to-beam model

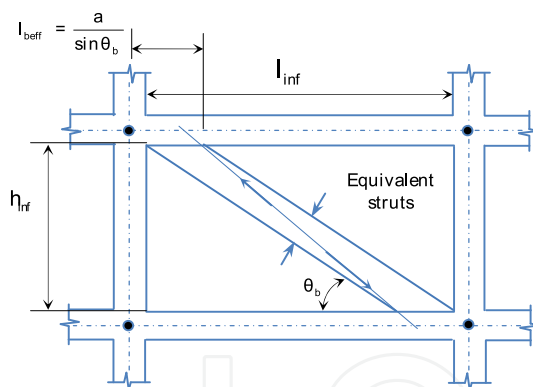

Fig. 3. Column-to-column model

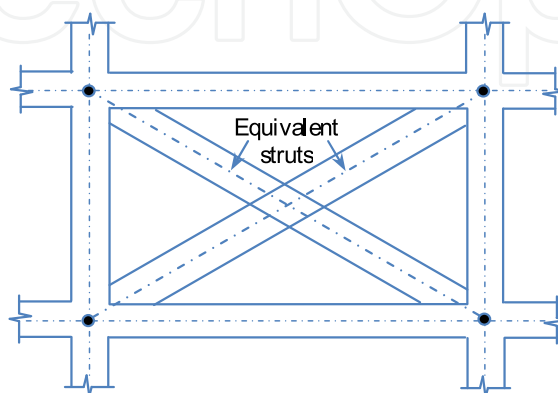

Fig. 4. Corner to corner model

No.	Advantages	Disadvantages
1	Higher stiffness and lower displacement	Stiffness irregularity in height (soft story)
2	Higher strength	Strength irregularity in height (weak story)
3	Lower ductility requirements	Stiffness irregularity in plan (torsion)
4	Higher base level in special conditions	Improper distribution of force between columns of a concrete frame
5	Ductile shear fracture in the steel short column	Improper distribution on force in plan (steel short column)
6	Frame design for small lateral loads	Increase in load design because of lower periods
7	Creation of couple system with axial action of frame	Increase on load design because of lower behavior factor for joint system

Table 1. Advantages and disadvantages of masonry infill walls on steel or concrete frame

3.1 Micro modeling

All models discussed here are based on the finite element method which generally utilize 3 types of elements for providing the masonry infill wall, frame and the interaction between them. In most cases, special attention has been focused on the contacting elements between frame and masonry infill walls. Then, it has been clarified that numerical simulation of the infill wall is very important and their nonlinear phenomena must be modeled with great levels of accuracy. Research on this problem is closely related to develop elements used in masonry structures (Tabeshpour, 2009b).

Mallick and Severn (1967), have taken into account the contact of wall to frame particularly. The masonry infill walls were modeled as the rectangular elastic elements with 2 degree of freedom. The frame was also modeled using the elements without axial deformation. The slip of the frame against wall was also noticed along with the friction between them. They compared the results of analyses with experimental works and offered accurate presentation of the stiffness.

Goodman et al. (1968) developed an element in order to simulate the interaction between frame and wall. The rectangular element of the plain strain with 4 nodes and 2 transitional freedom degree in each node was modified to consider the contact condition properties. The shear strength of the element is dependent on adhesion and friction. This study has proposed a moderate mode between wall and frame with given length and zero initial width.

Researches from Malik and Garg (1971) modeled the effect of existence of shear slot between frame and masonry wall. They used the rectangular element of plain strain for the wall similar to the above mentioned technique. They also proposed that in the model of beam member for frame, the rotational degree of freedom must not be considered, which means that the frame must only be deformed under the shear and axial loads. This model was used to study 2 issues: the effect of openings available in the masonry infill wall in addition to the effect of shear slot available between frame and infill walls. Experimental work was also launched to evaluate the validity of the results.

Koset et al. (1974) observed that infill walls and frame cracks are occurred and developed even in little lateral loads. This is attributed to the low tensile strength at the contact between infill walls and frame. Therefore, in order to simulate the system's response under

the lateral load, opening/closing of gaps between masonry infill walls and frame must be considered.

King and Pandey (1978) used the element proposed by Goodman and his coworkers. Primary tests showed that the curves of shear stress were elasto-plastic in contact between the elements. Tangential stiffness characteristics (K_n and K_s) of the moderate elements were defined as functions of these elements. That was how the frictional slip of connection/separation between the elements was studied. They achieved acceptable results from Mallick and Severn (1967) models.

Liau and Kwan (1984) advanced a plastic theory which allowed three different fracture modes. Based on the relative strength of columns, beams and masonry infill walls behaviour, three type of failure are mention below.

- Corner crushing of infill walls and fracture in columns
- Corner crushing of infill walls and fracture in beams
- Diagonal crack of masonry infill walls

Rivero and Walker (1984) developed a nonlinear model for simulating the response of the frame system which is Infilled by walls and is under stimulus of earthquake. 2 types of element were developed base on surface between frame and walls. Gap element and the connection element. The former was used aiming to show the distance between frame and infill walls in no tangential conditions, while the later was utilized to model the contact mode. The process of crack formation and development was studied carefully.

Shing et al. (2002) simulated the nonlinear behavior of the masonry wall elements using the plasticity theory. The cracks through bricks and mortar as well as the cracks between mortar joint and members of reinforced concrete were modeled and studied. In this model, overall behavior of the combined system before cracking was considered homogeneously and isotropically. The behavior of materials was presumed elasto-plastic based on the Von Mises yield criterion with tensions of Rankeen type. After calibrating the model by using experimental studies, the finite element model was capable to simulate the actual behavior of the system properties.

3.2 Macro modeling

The idea of using a simple member for simulating infill walls inside the frame has always been attractive, and has several advantages in the process of analysis and design. At the beginning, it was explained that a diagonal strut with appropriate mechanical properties can be a suitable candidate for walls. By using the diagonal strut model, it will be possible to enter the following items to the model:

- Shear stiffness of the infill wall,
 - Small shear and tensile stress of column at the contact between wall and frame,
- Although this simple model cannot notice the following complexities in the model:
- Decreasing the stiffness and strength under cyclic loads,
 - Out of plane behavior for masonry infill walls when diagonal crack occurred,
 - Shear slip along joints which occurs at the middle height of infill walls.

These problems were solved to some extent in the equivalent strut model. For example, Klinger and Bertero (1976) modeled masonry infill walls with two equivalent struts and noted the effects of stiffness dimming. Polyakov (1956) studied the normal and shear stresses at the middle of infill walls, using the variation calculation method and offered a numerical technique to estimate the load which cause diagonal crash.

Holmz (1961) presented formula for a diagonal strut for the first time. He assumed that the width of equivalent strut is equal to one third of the diagonal length. After that, several studies were performed to define the width of the equivalent strut.

Stafford Smith (1968) observed that the equivalent diagonal strut has many simplifications and some modifications must be done on its equivalent width. He assumed that the distribution of the interactional forces between frame and infill walls is triangular. This idea has a very high accuracy and is still in use. Based on the interaction length between infill walls and frame, other proposals were introduced by Mainstone (1971) and Kadir (1971).

Klinger and Bertero (1976) provided the first diagonal member with cyclic behavior which was able to consider the stiffness dimming behavior through the modeling procedure.

Chrysostomou (1991) investigate the behavior of the frame and the infill wall system under the earthquake loading regarding the effects of decreasing of stiffness and wall strength. He modeled the wall in any diagonal direction with three bars based on Fig. 8. The αL length is equal to the plastic hinge in column or beam. These members act compressively.

The effective width of equivalent strut in the infill wall proposed by different researchers has severe variation from 10 to 35%. Table 1 summarizes different relations for the effective width of equivalent brace in the masonry infill walls and Tabeshpour recommends some values for effective width in Hand book, part 18 (page 65) (2009). Modeling of infill wall using commercial softwares is needed for design purposes (Tabeshpour, 2009e).

Researcher		Effective Width (b_w)	λh	
Holmes (1961)		$b_w = [0.33]d_w$	-	170 (max)
Mainstone (1971)		$b_w = 0.16(\lambda h)^{-0.3} d_w$	5	50
Klingner and Bertero (1978)		$b_w = 0.175(\lambda h)^{-0.4} d_w$	5	45(min)
Liau and Kwan (1984)		$b_w = 0.95h_w \cos \theta (\lambda h)^{-0.5}$	5	90
Paulay and Priestley (1992)		$b_w = [0.25]d_w$	-	125
Recommended	Upper band, Negative Effect	$b_w = [0.2]d_w$	-	100
	Lower band, Positive Effect	$b_w = [0.1]d_w$	-	50

Table 2. Different formulae of equivalent masonry strut's effective width

3.3 Yung’s modulus of masonry materials

The important point about Young’s modulus of masonry materials is the range of values obtained from the relations proposed by different researchers which is attributed to the nature of masonry materials. Table 2 lists some relations presented by some researchers as well as the value of Yung’s modulus for 15 Kg/cm² compressive stress (Tabeshpour Hand book, part 18, 2009). Shear strength of materials are usually demonstrated in codes by static friction relation as show in follow:

$$\tau = \tau_0 + \mu\sigma_y \tag{1}$$

τ_0 : Joint shear strength

$\mu\sigma_y$: Frictional strength component

μ : Internal frictional factor

σ_y : Normal stress component along the horizontal direction

Researcher	Module of Elasticity	$E_m(\text{kg/cm}^2)$ $f_m=15 \text{ kg/cm}^2$
Sahlin (1971)	$E_m = 750 f_m$	1100
Paulay and Priestley (1992)	$E_m = 750 f_m$	1100
Sanbartolome (1990)	$E_m = 500 f_m$	7500 (min)
Sinha&Pedreschi (1983)	$E_m = 1180 f_m$	16000
Hendry (1990)	$E_m = 2116 f_m$	25000 (max)
Some others	$E_m = 1000 f_m$	15000

Table 3. Module of elasticity for equivalent masonry struts

Researcher	Shear bond strengths, τ_0
Hendry (1990)	0.3 to 0.6 MPa
Shrive (1991)	0.1 to 0.7MPa
Paulay and Priestley (1992)	0.1 to 1.5MPa

Table 4. Shear bond strength for equivalent masonry struts

Researcher	μ
Sahlin (1971)	0.1 to 1.2
Stöckl and Hofmann (1988)	0.1 to 1.2
Atkinson <i>et al.</i> (1989)	0.7 and 0.85
Hendry (1990)	0.1 to 1.2
Paulay and Priestley (1992)	0.3 for design purposes

Table 5. Ductility for equivalent masonry struts

4. Failure modes

4.1 Soft Story

The base floors of the existing buildings are generally arranged as garages or offices. No walls are built in these floors due to its prescribed usage and comfort problems. But upper floors have walls separating rooms from each other for the residential usage. In these arrangements, the upper floors of most buildings are more rigid than their base floors. As a result, the seismic behaviors of the base and the upper floors are significantly different from each other. This phenomenon is called as the weak-story irregularity. Weak stories are subjected to larger lateral loads during earthquakes and under lateral loads their lateral deformations are greater than those of other floors so the design of structural members of weak stories is critical and it should be different from the upper floors.

Sattar and Liel (2000) shown in their results of pushover analysis that infill walls were increased the initial stiffness, strength, and energy dissipation of the infilled frame, compared to the bare frame, despite wall's brittle failure modes. Vulnerability and damage analysis of existing buildings using damage indices have been presented by Golafshani et al. (2005). Such studies can be used for quantitative investigation of existing buildings. A case-study structure that collapsed because of a soft-story mechanism during the 2009 L'Aquila earthquake was studied with Verderame et al. (2009). Their study presented some peculiar details and results, but it could not be stated. It represents a common practice in the L'Aquila building stock.

Haque and Amanat (2009) shows that, when RC framed buildings having brick masonry infill on upper floor with soft ground floor is subjected to earthquake loading, base shear can be more than twice to that predicted by equivalent earthquake force method with or without infill or even by response spectrum method when no infill in the analysis model.

Tena-Colunga (2010) evaluated how the soft first story irregularity condition should be defined: (a) as a significant reduction of the lateral shear stiffness of all resisting frames within a given story, as established in the seismic provisions of Mexican building codes or, (b) as a substantial reduction of the lateral shear stiffness of one or more resisting frames within a given story, as proposed by the author.

Kirac et al. (2010) studied the seismic behavior of weak-story. Calculations were carried out for the building models which are consisting of various stories with different storey heights and spans. Some weak-story models were structural systems of existing buildings which were damaged during earthquakes. It was observed that negative effects of this irregularity could be reduced by some precautions during the construction stage. Also some recommendations were presented for the existing buildings with weak-story irregularity.

A conceptual and numerical analysis for investigating the effect of masonry infills on seismic behavior of concrete frames considering various type of infill arrangements was presented by Tabeshpour et al (2004). It was found that a large drift is concentrated in soft story (the story with no infill). Design of columns in soft stories is an important problem to have an acceptable mechanism in severe earthquakes. In order to avoid from soft story failure, columns should be designed for increased loads, Tabeshpour (2009f) has investigated increasing design load in specific columns and presented a simple formula for this purpose.

Researcher	$\delta_{cr}(\%)$	$\delta_{max}(\%)$			Other note
	URM	URM	Frame + Infill	Bare Frame	
Fiorato (1970)			1.1		
Zarnic & Tomazevic (1984)	0.2		1	3	
Govindan et al. (1986)			3	1.5	
Valiasis & Stylianidis (1989)			0.6	1	$\tau_u \approx 0.25 - 0.3 \text{ Mpa}$
Carydis et al. (1992)					Good system behaviour up to 0.14% drift; steel frame with infill
Pires&Carvalho (1992)	0.1		0.5		$\tau_u \approx 0.27 - 0.51 \text{ Mpa}$
Shing et al. (1992)					$\tau_u \approx 0.34 \text{ Mpa}$
Valiasis et al. (1993)	0.2 to 0.3				
Fardis & Calvi (1995)					δ_{max} for URM is 0.1 δ_{max} for frame
Zarnic (1995)	0.1	0.3	0.6	2	
Pires et al. (1995)			0.3	2	$V = 0.8, V_{max}$ at 6% drift
Manos et al. (1995)	0.15		0.3	1	$\tau_u \approx 0.3 \text{ Mpa } V = 0.8,$ V_{max} at 2% drift for infill frame
Michailidis et al. (1995)	0.1	0.25-0.35			
Mehrabi et al. (1996)	0.3		0.6	3.1	$\tau_u \approx 0.5 \text{ Mpa}, V = 0.8,$ V_{max} at 1.5% drift for infilled frame, 6.8% for bare frame
Negro & Verzeletti (1996)	<0.3		1.1	2.4	$V_{max} = 0.4W$ for bare frame. $V_{max} = 0.62W$ for infilled frame
Aguilar (1997)			1.3		
Marjani (1997)	0.5				
Zarnic & Gostic (1997)		0.2	1	>1	
Zarnic (1998)			0.3		$V = V_{max}$ for 0.3% < δ < 2% Used in mathematical model of URM infill
Kappos et al. (1998)	0.3		3		
Schneider et al. (1998)	0.2		2		
Mosalam, White and Ayala (1998)	$\pm 0.1\%$ and $\pm 0.2\%$		0.5		
Mehrabi & shing (1998)	0.013% to 0.037%		2% to 4.3%		
Lili Anne Akin (2004)	0.3		0.7		
Al-Chaar et al. (2002)	0.25% to 1%				
Santiago et al. (2008)	1				$K_{infill} = 5K_{bare}$ $f_{infill} = 2f_{bare}$

Table 6. Deformation limitations

4.1.1 Conceptual discussion

One of the main reasons of failure of structures due to earthquakes is discontinuity of lateral force resisting elements like bracing, shear wall or infill in the first story as show conceptually in Fig. 5. So first story act as soft story, in this case columns are imposed to large deformation and plastic hinges are formed at top and bottom of the element. Conceptual figure is obtained from actual earthquake observation as shown in fig. 6. This phenomena is so-called story mechanism (severe drift of the story). Most of these buildings have collapsed. The upper stories have infills and consequently their stiffness is much more than the first story.

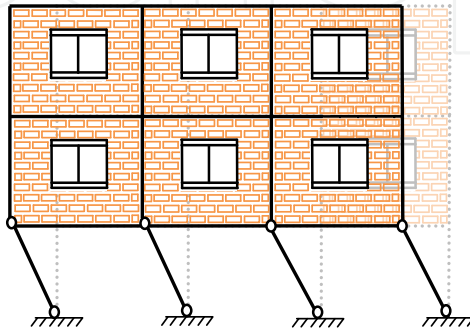

Fig. 5. Schematic view of soft story mechanism

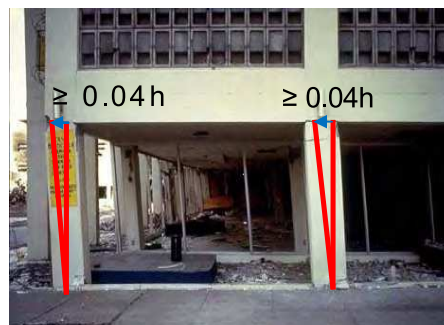

Fig. 6. Soft story failure in a building during earthquake (Italy 1976)

The performance of a building in earthquake is shown in Fig. 6. This building is RC structure and has parking in the first story; there is no infill in the parking story. Deformations are localized in the first story and the columns of this story undergo large deformation, passing collapsed limit (4% of height).

4.2 Torsion

The effects of masonry infill walls in the structures are significant and very important in seismic responses of structures due to the experiences of the previous earthquakes. Many existing buildings are irregular in plan or elevation because of asymmetric placement of masonry infills. This kind of torsion should be considered by engineers.

The inelastic seismic response of a class of one-way torsionally unbalanced structures is presented By Bozorgnia et al. (1986). Tso (1988) shown that much better correlation exists between inelastic torsional responses and strength eccentricity than the traditionally used stiffness eccentricity parameter. Tso and Ying (1990) used a single mass three-element

model, a study was made on the effect of strength distribution among elements on the inelastic seismic responses of eccentric systems. Additional ductility demands on elements and additional edge displacements are taken as response parameters of interest in optimizing the strength distribution.

Yoon and Stafford Smith (1995) presented a method to predict the degree of translational-torsional coupling of mixed-bent-type multistory building structures subject to dynamic loading.

Chopra and De la Llera (1996) focused on the description of two recently developed procedures to incorporate the effects of accidental and natural torsion in earthquake analysis and design of asymmetric buildings. Basu and Jain (2004) presented the definition of center of rigidity for rigid floor diaphragm buildings has been extended to unsymmetrical buildings with flexible floors.

Stefano et al. (2007) presents an overview of the progress in research regarding seismic response of plan and vertically irregular building structures. Dai Junw et al. (2009) shown some analytical results from 3D temporal characteristics of the responses of an RC frame building subjected to both a large aftershock and the main shock of Wenchuan $M_s = 8.0$ earthquake.

4.2.1 Conceptual discussion

Fig. 6 is a sample of previous earthquakes that shown the response of plan asymmetric structure. As a result, design codes incorporate procedures to account for such irregular plan-wise displacement distribution, leading to different stiffness's and capacities of resisting planes. Several researchers have carried out numerical and experimental investigations to understand these effects. The stiffness of masonry infill is a considerable value relating to that of the structure. Because of architectural and structural considerations, sometimes there is an eccentricity between center of mass and center of rigidity and the structure is irregular in plan called asymmetric building. The structure is also might be asymmetric as an irregular arrangement of infills in plan, which leads to unbalance distribution of stiffness. Produced torsion from eccentricity because of infill stiffness leads to extra forces and deformations in structural members and diaphragms. An appropriate alternative to solve this problem especially in existing buildings is using dampers.

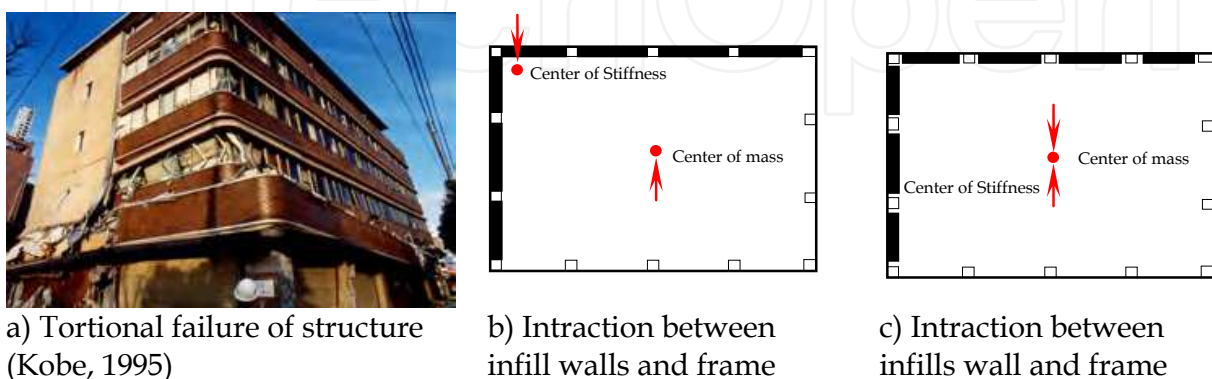

Fig. 7. Torsion of building

4.3 Short column

Shear failure is a critical kind of concrete column failure that occurs in short columns as repeatedly demonstrated during recent earthquake. Due to high brittle behavior and low ductility of these types of columns, it is important to investigate the behavior of short columns.

Moehle et al. (2000) examined loss of lateral and vertical load capacities by a study of columns tested in the laboratory. Correlations with geometric, materials, and loading characteristics were identified. They gathered test data to understand the effects of materials, geometry, and loading on failure mechanisms. Sezen and Moehle (2006) shown that columns with inadequate transverse reinforcement were vulnerable to damage including shear and axial load failure by earthquakes and laboratory experience. To study this behavior, they tested four full scale columns with light transfers reinforcement under unidirectional lateral load with either constant or varying axial load. Their tests shown that response of columns with nominally identical properties varied considerably with magnitude and historical and lateral loads. Kwon (2007) presented back-analysis result of a RC building in Ica, Peru which was severely damaged during the Pisco-Chincha Earthquake. Kwon confirmed in analysis results that shear force demand on columns with infill walls was significantly higher than those without infill walls. Turel Gur et al. (2007) made three surveys of damage to concrete structures following the 1999 Marmara and Düzce earthquakes. They observed that the sole severely damaged structure was damaged not by failure in the ground story, as all the other school buildings, but by failure of captive columns at basement level as a result of discontinuity of the foundation walls in height. The structural walls of the building, which were not damaged at all, prevented the collapse of the building by providing sufficient lateral strength and enhancing the gravity load capacity. Their observation was that the presence of structural walls improved the behavior of reinforced concrete systems drastically. Tabeshpour et al. (2005) presented numerical study of short column failure using IDARC. Non-ductile behavior of short columns was modeled for nonlinear damage analysis. Tabeshpour and Mousavy (2011b) presented plastic hinge properties for short column surveying because of masonry infill wall using nonlinear static analysis.

4.3.1 Conceptual discussion

4.3.1.1 Local short column

4.3.1.1.1 Flexural failure

Flexural failure in columns depends on the shear span ratio that is:

$$a_s = M / (VH) \quad (2)$$

Slender columns ($a_s > 3.5$) are characterized by a flexural type of failure. This type of damage consists of spalling of the concrete cover and then crushing of the compression zone, buckling of longitudinal bars and possible fracture of hoops due to the expansion of the core (Elnashai and Sarno, 2008).

4.3.1.1.2 Shear failure

Short columns ($a_s < 2$) are characterized by a shear failure presented a brittle failure. This type of failure occur when columns have conventional reinforcement (hoops and

longitudinal bars) and high axial load, when subjected to cyclic loading results in cross-inclined shear cracks. This behavior may be improved if cross-inclined reinforcement is utilized, and particularly if multiple cross-inclined reinforcement (forming a truss) is used. Some columns in RC frames may be considerably shorter in height than the other columns in the same story. Short columns are stiffer, and require a larger force to deform by the same amount than taller columns that are more flexible. Regarding to earthquake damage photos due to short column phenomena increased force generally incurs extensive damage on these columns. The upper portion of the column next to the window behaves as a short column due to the presence of the infill wall, which limits the movement of the lower portion of the column. In many cases, the heights of the columns in each story are the same, as there are no walls adjoining them. When the floor slab moves horizontally during an earthquake, the upper ends of all columns undergo the same displacement. Effective height of columns is shorter when masonry infills added during construction. Consequently these columns attract a larger force as compared to a regular column. The damage in these short columns as shown in fig. 7 is often in the form of X-shaped cracks, which is characteristic for shear failure. In new buildings, the short column effect should be avoided during the architectural design process.

4.3.1.2 Global short column (very stiff non-ductile story)

Earthquake observation indicates that, total collapse of the story occurs, due to shear failure of the columns in the story. If the negative effects of infill walls are not consider in design procedure, brittle failure in low drift ratio may occur and it makes detritions drop in strength.

4.4 Interaction

Interaction between infill walls and concrete columns cause the brittle failure as repeatedly demonstrated during recent earthquake. Existing of infill walls and adjacent to concrete frames is the most important and determinant effects in behavior of concrete structures during earthquake. During recent earthquake great damage occur because of interaction phenomena.

Smith & Coull (1991) presented a design method for infilled frame based on diagonally braced frame criteria. They proposed a method that considered three possible failure modes of infill: shear along the masonry, diagonal crushing of infill walls and corner crushing of infill. Paulay & Priestley (1992) proposed a theory about the seismic behavior of masonry infilled frame and a design method for infilled frames. They said that although masonry infill may increase the overall lateral load capacity, it can result in altering structural response and attracting forces to different or undesired part of structure with asymmetric arrangement. This means that masonry infill may affect on structural behavior in earthquake.

Bell and Davidson (2001) reported on the evaluation of a reinforced concrete frame building with brick infill walls. They used in their evaluation an equivalent strut approach for modeling the infill walls. Their results indicated that infill walls, where presented in a regular arrangement, had a significant beneficial influence on the behavior of RC buildings that contrasted with New Zealand guidelines which gave an impression that infill masonry walls had a detrimental influence on the behavior of buildings due to interaction effects.

Naseer et al. (2007) overviewed buildings damaged during October 08, 2005 Kashmir earthquake. They understood that most of the buildings in the earthquake affected area were non-engineered. The following conclusions were drawn from the analysis of data collected in the post-earthquake damage assessment surveys that most of the buildings are either non-engineered or semi-engineered before October 08, 2005 earthquake. Mohyeddin-Kermani et al. (2009) focused specifically on observations made on concrete construction with masonry infill walls during the Sichuan earthquake with identification of damage and key of failure modes. This will be related to the damage and failure modes observed in past earthquakes because of interaction between masonry infill walls and concrete frame. Baran and Sevil (2010) studied on behavior of infilled frames under seismic loading. They considered hollow brick infills as “structural” members during the structural design process. They emphasized that since the behavior is nonlinear and closely related to the interaction conditions between frame and infill, analytical studies should be revised and supported by experimental data.

4.4.1 Conceptual dissection

Earthquake reports indicate the negative effect of infill wall as shown in fig. 7-9. Due to observation, damage of structure because of interaction effects categorize in two groups:

- a. Interaction between masonry infill walls and concrete frame (Fig. 8)
- b. Interaction effects in confined masonry structure (Fig. 9)

Design procedure of infilled frame structure in most codes is base on the bare frame. Earthquake observation indicate that infill frame have effective role in response of structure. Local damage of infill walls in recent earthquake indicate that the actual behavior of structure adjust to the material strength basis.

Confined masonry building is commonly used structure both in small cities and rural areas. This type of structure is very similar to infilled frames with two differences: masonry walls carry vertical loads and tie beams are not moment frames and don't carry vertical loads. Fig. 10 shows the interaction effect between tie beams and masonry wall. Because of concentrated shear force, the corner part of the beams is very vulnerable and shear cracks occur in earthquakes (Fig. 9).

In order to have a deep view on the structural behavior of infilled frames, simplified models of infills and frames are presented in table 7.



Fig. 8. shear failures in columns (California 1994)



Fig. 9. Shear failure of column (Italia 2002)



Fig. 10. interaction between infill wall and vertical tie beam

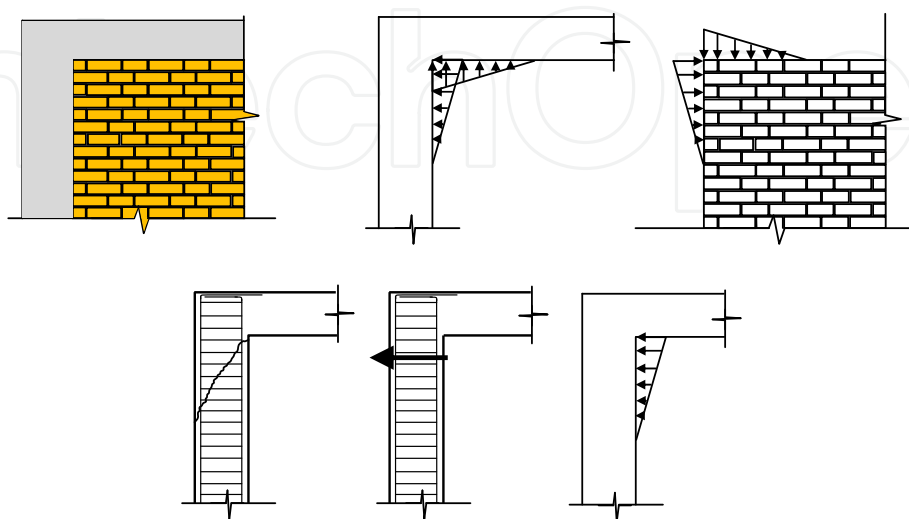

Fig. 11. Impose force from masonry wall into vertical tie beam

Capacity Curve	Strength (F_y)	Stiffness (k)	System
	0	0	
	$\frac{A_m}{l} f_m \cos \theta =$ $\frac{t \times a}{l} f_m \cos \theta =$ $t \times a \times f_m \cos \theta$	$\frac{A_m E_m}{l} \cos^2 \theta =$ $\frac{t \times a \times E_m}{l} \cos^2 \theta =$ $t \times a \times E_m \cos^2 \theta$	
	$\frac{4M_p}{h}$	$\frac{24E_s I}{h^3}$	
	$\frac{4M_p}{h} + t \times a \times f_m \cos \theta$	$\frac{24E_s I}{h^3} +$ $t \times a \times E_m \cos^2 \theta$	
	$\frac{0.5\sqrt{f'_c}}{h'/d} \sqrt{1 + \frac{P}{0.5\sqrt{f'_c} A_g}} 0.8A_g$ $+ A_m f_m \cos \theta$	$\frac{24E_s I}{h'^3}$	
	$\frac{0.5\sqrt{f'_c}}{h'/d} \sqrt{1 + \frac{P}{0.5\sqrt{f'_c} A_g}} 0.8A_g$ $+ A_m f_m \cos \theta$	$\frac{24E_s I}{h'^3}$	
	$2M_p \left(\frac{1}{h} + \frac{1}{h'} \right)$ $+ A_m f_m \cos \theta$	$\frac{24E_s I}{h'^3}$	

Table 7. Simplified models for capacity curves

5. Case study

Tabeshpour et al. (2011c) showed that the infill walls can lead to severe torsion increase through the frame which can be solved by using friction damper device. We can say that in the irregularities and changes in structural properties because of infill walls will not be considered, the structural design may be inefficient and the seismic response of the structures may not be acceptable. Tabeshpour and Ebrahimian, (2010) have presented design of friction/yielding damping devices. Considering the infill walls leads to determine the period of the structure in high accuracy and therefore, the seismic responses will be reliable and the design of a friction damper will be performing in a correct way. Many control devices have been developed to achieve the first purpose, and they have been applied to high-rise buildings and towers such as friction damper device (FDD) (Mualla and Belev, 2002). Friction damper is the simplest kind of dampers and easy to construct and install. The second purpose of vibration control is to prevent of imparting damage to the main elements of a structure during severe earthquakes. In seismic design of friction dampers, the structural stiffness and fundamental period directly affect the damper properties.

5.1 Modeling of masonry infill walls

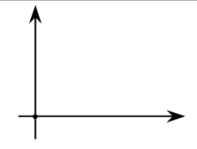
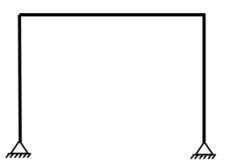
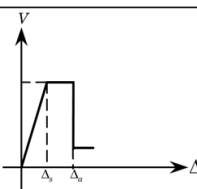
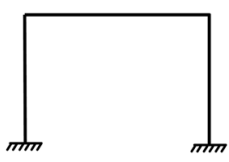
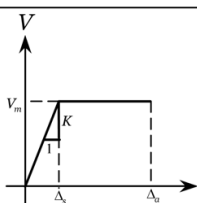
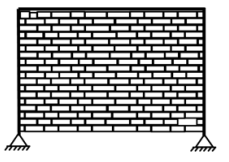
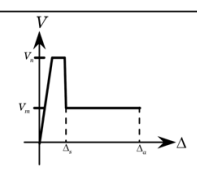
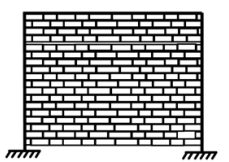
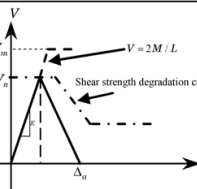
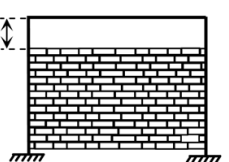
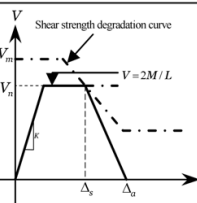
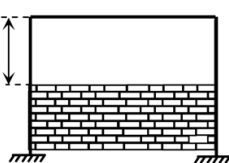
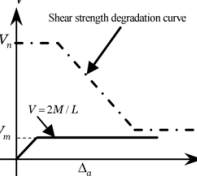
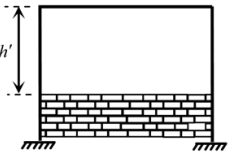
From experimental observations, it is evident this type of structure exhibits a highly nonlinear inelastic behavior, even at low-level loading. The nonlinear effects mentioned above introduce analytical complexities, which require sophisticated computational techniques in order to be properly considered in the modeling. Due to the stiffness and strength degradation occurring under cyclic loading, the infilled frame structures cannot be modeled as elasto-plastic systems, while models that are more realistic should be used to obtain valid results, especially in the dynamic analysis of short period structures, such as infilled frames. The aim of this chapter is to introduce the modeling of a masonry infill walls, which will implement in the analysis in the following chapter. The elastic in-plane stiffness of a solid unreinforced masonry infill walls prior to cracking shall be represented with an equivalent diagonal compression strut of width, a , given by the following equation:

$$a = 0.25(\lambda h_{col})^{-0.4} r_{inf} \quad (3)$$

$$\lambda_1 = \left(\frac{10E_{me}t_{inf} \sin 2\theta}{E_{fe}I_{col}h_{inf}} \right)^{0.25} \quad (4)$$

where:

h_{col} = Column height between centerlines of beams, cm

h_{inf} = Height of infill walls, cm.

E_{fe} = Expected modulus of elasticity of frame material, kg/cm

E_{me} = Expected modulus of elasticity of infill material, kg/cm

I_{col} = Moment of inertia of column, cm

L_{inf} = Length of infill walls, cm.

r_{inf} = Diagonal length of walls panel, cm.

t_{inf} = Thickness of infill walls and equivalent strut, cm

θ = Angle (it's tangent is the infill height-to length, radians)

λ_1 = Coefficient used to determine equivalent width of infill strut

The equivalent strut shall have the same thickness and modulus of elasticity which is represented in fig. 4.

E_{me} (kg / cm ²)	t_{inf} (cm)	λ_1	a (cm)
12000	20	0.009043	71.95

Table 8. Summary of calculated masonry parameters

5.2 Parameters of compression equivalent strut

In this research equivalent compression strut used instead of masonry infill walls. This strut is in a diagonal and node-to-node manner whose length is equal to the diameter of the frame and its effective width is 0.2 of the diameter of the frame. The thickness of strut is same as the wall's thickness.

In order to obtain the masonry materials of strut, Australia's building code was used concerning the conventional compression bricks and mortars which produce stress-strain curves below relating to the mode of a 23cm one. The equation of stress-strain of masonry materials (bricks) in compression is considered as a parabolic function up to the maximum stress (f_{m0}) based on Table 9. Then with increase in strain, the value of stress decreases linearly, therefore it remains constant. These values are described in details in appendix.

Parameter	Value
Thickness	23 (Cm)
f_{m0}	4 (Mpa)
ϵ_{m0}	0.0014
f_{mu}	0.8 (Mpa)
ϵ_{mu}	0.0028

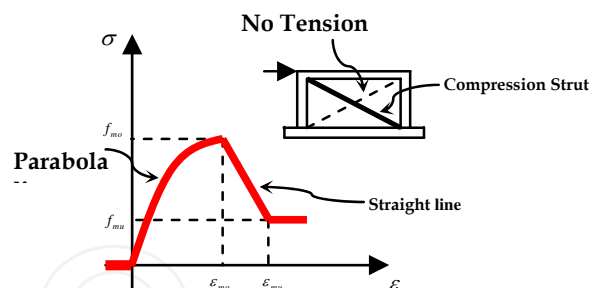

Table 9. Equivalent masonry strut's material properties

5.3 Damper description and principle of action

Friction dampers have often been employed as a component of these systems because they present high energy-dissipation potential at relatively low cost, easy to install and maintain. A friction damper is usually classified as one of the displacement-dependent energy dissipation devices, because its damper force is independent from the velocity and frequency-content of excitations. A friction damper is activated and starts to dissipate energy only if the friction force exerted on its friction interface exceeds the maximum friction force (slip force); otherwise, an inactivated damper is no different from a regular bracing. This device used to dissipate the energy not only in the usual structure (building) but also it used in platforms and jackets (offshore structure) as well (Komachi et al., 2011).

The damper main parts are the central (vertical) plate, two side (horizontal) plates and two circular friction pad discs placed in between the steel plates as shown in Fig. 11. The central plate has length h and is attached to the girder mid span in a frame structure by a hinge. The hinge connection is meant to increase the amount of relative rotation between the central and side plates, which in turn enhances the energy dissipation in the system. The ends of the two side plates are connected to the members of inverted V-brace at a distance r from the FDD center. The bracing makes use of pretension bars in order to avoid compression stresses and subsequent buckling. The bracing bars are pin-connected at both ends to the damper and to the column bases. The combination of two side plates and one central plate increases the frictional surface area and provides symmetry needed for obtaining plane action of the device. When a lateral force excites a frame structure, the girder tends to displace horizontally. The bracing system and the forces of friction developed at the interface of the steel plates and friction pads will resist the horizontal motion. Fig. 11 explain the functioning of the FDD under excitation. As is shown, the device is very simple in its components and can be arranged within different bracing configurations to obtain a complete damping system.

5.4 Numerical study

A 3-story frame with 3 bays has been investigated in this study. Fig. 12 show plan and elevation of the building. Frame A has been filled by masonry walls with thickness of 23 cm. Lateral force resisting system is intermediate steel moment frame and the type II of soil according to Iranian seismic code of practice (Standard No. 2800). Since investigating the effects of masonry infill walls is the main goal of this research, the considered frames are designed according to last version of Iranian building codes without considering infill walls. Dimensions of the elements have been shown in Table 10. Dead and live loads of stories are considered $600 \text{ (kg/m}^2\text{)}$ and $200 \text{ (kg/m}^2\text{)}$ respectively. These parameters are considered $550 \text{ (kg/m}^2\text{)}$ and $150 \text{ (kg/m}^2\text{)}$ respectively for roof story. Dead load is considered $133 \text{ (kg/m}^2\text{)}$ for 23 cm thick walls respectively.

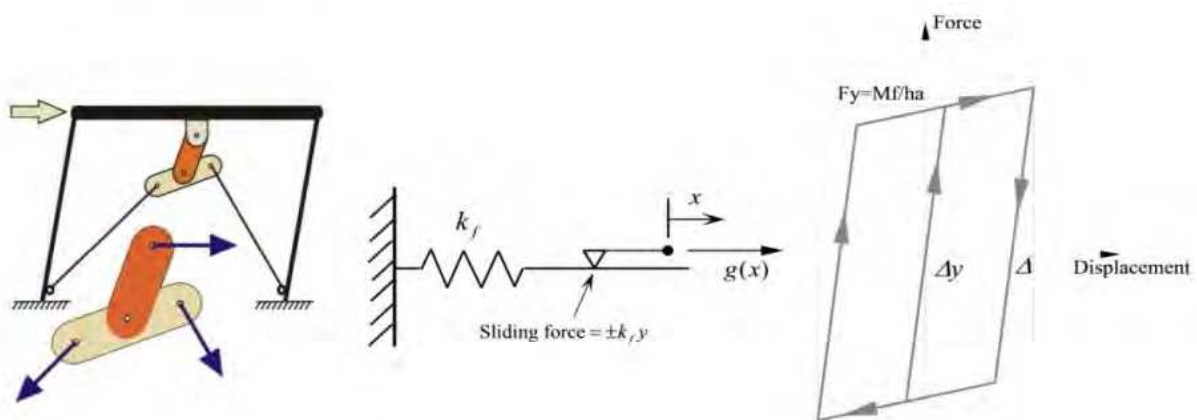

Fig. 12. Component of FDD

In order to compare the behavior of the original structure and equipped structure, the pushover curves of three cases are shown in Fig. 13. Infill walls lead to increase stiffness and strength of buildings compared to a building without considering infill walls. Changing the slope in pushover curves shows this phenomenon. In the push over curves with friction

damper, stiffness and strength of buildings in the elastic part of analysis are increased. Since infill walls are brittle material and have a high stiffness, these walls absorb a large amount of lateral load until they fail. After failure of infill walls, we have a drop of stiffness (slope) and strength in curves. As it can be seen in the figure after failure of the infill walls, the slope of the curve will be the same as bare frame. The local interaction between frame A and infill walls is not considered. These results are achieved when the shear strength of columns are sufficient. This can be supposed in steel structures. In order to have a clear sense of the effect of infill and friction damper on the structural behavior, Fig.14 shows the scaled deformations of 3 cases named on Fig.13 as a, b and c.

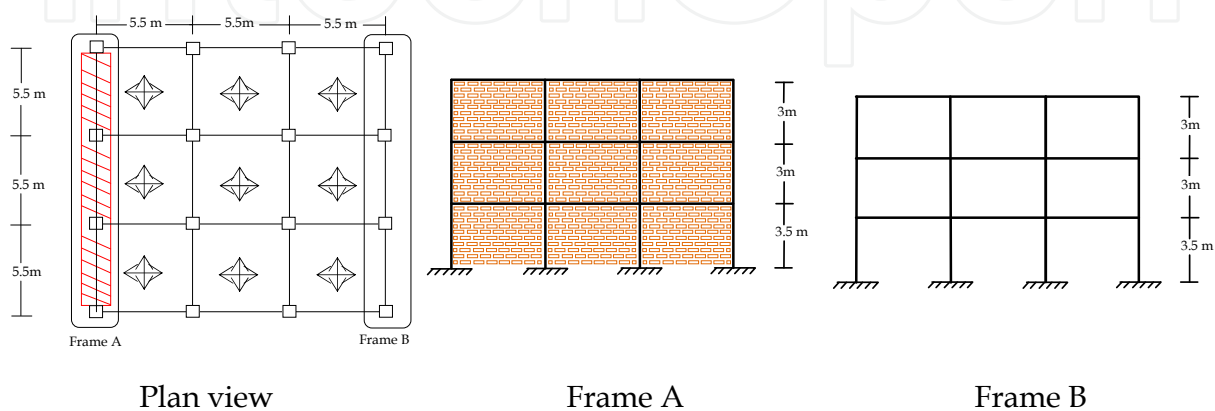

Fig. 13. Building elevation

Story	Column		Exterior Beam		Interior Beam	
	Dimension (cm)	Thickness (cm)	Web (cm)	Flange (cm)	Web (cm)	Flange (cm)
1	25×25	1	30×1	12×1	30×1	15×1
2	20×20	1	30×1	12×1	30×1	15×1
3	20×20	1	30×1	12×1	30×1	15×1

Table 10. Details of element sections

As shown in Fig. 14 by adding infill walls to the bare frame they lead to increase the stiffness of the system and the torsional problems occurs. This torsion leads to structural failure because of concentration of stress in one side and concentration of deformations in the other side. By using friction damper, eccentricity can be omitted and the distance between the center of mass and center of stiffness will be controlled to satisfy code requirement. In region I with increasing lateral deformation, rotation is increased both in infilled frame and equipped frame. However in this region the rotation at equipped frame is considerably less than infilled frame. This reduction of rotation is because of transforming asymmetric system (infilled frame) to a symmetric system (equipped frame). When infill walls start to fail, rotation starts to reduce Region II in the case of equipped frame. But for asymmetric infilled frame, the rotation increases with increasing lateral drift. In region III failing the infill walls cause to reduce the eccentricity and torsional rotation. Therefore the rotation decreases with

increasing lateral displacement. In the case of equipped frame, failing the infill walls leads to increase rotation clockwise.

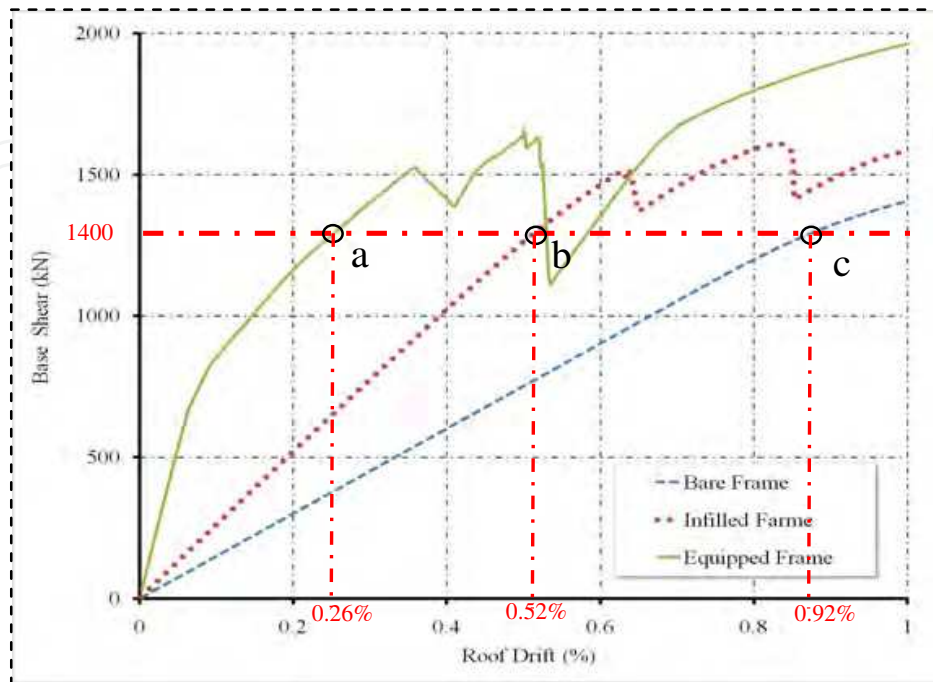

Fig. 14. Pushover curves

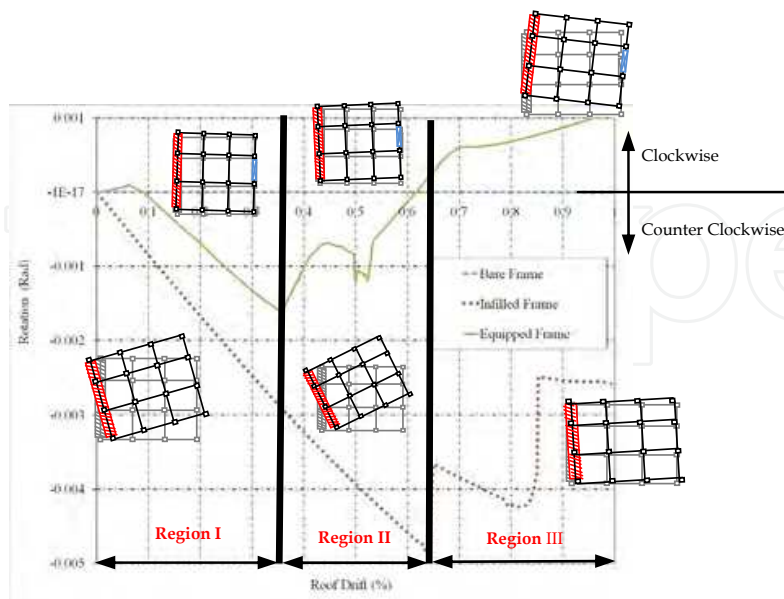

Fig. 15. Rotation curves for center of mass

After record selection procedure the maximum response of the structure with this arrangement are selected. In this type of structure, in Y direction infill wall is applied in one side and it changes the center of mass and stiffness in the structure. This eccentricity makes torsion in the plan. By applying the FDD in the perpendicular directions decreasing the eccentricity is possible.

Acceleration time history of Loma Perita earthquake has been shown in Fig. 15. Displacement time history response for bare and infilled frame under Loma Perita earthquake has been shown in Figs. 16 and 17 respectively. Comparing Figs. 17 and 18 it is seen a considerable reduction in response when it is equipped by FDD.

Earthquake	Data	Site	Station and Component	M	R(km)	PGA (g)	PGV (cm/s)	PGA/PGV (s)
Loma perieta	24.4.1989	Soil	Holister - South & Pine	6.9	27.9	1.298	37.1	15.8

Table 11. Details of records

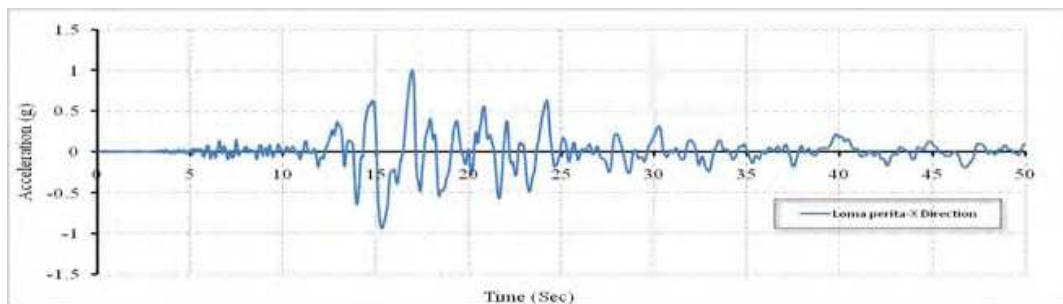

Fig. 16. Acceleration Time History of Loma Perita Earthquake

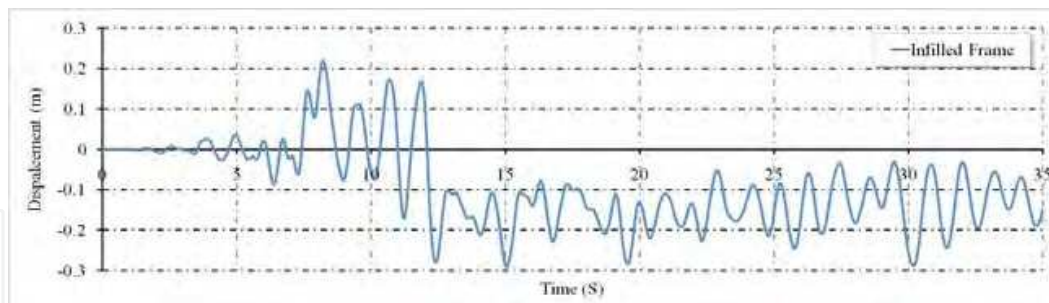

Fig. 17. Time history response for bare frame under Loma perita earthquake

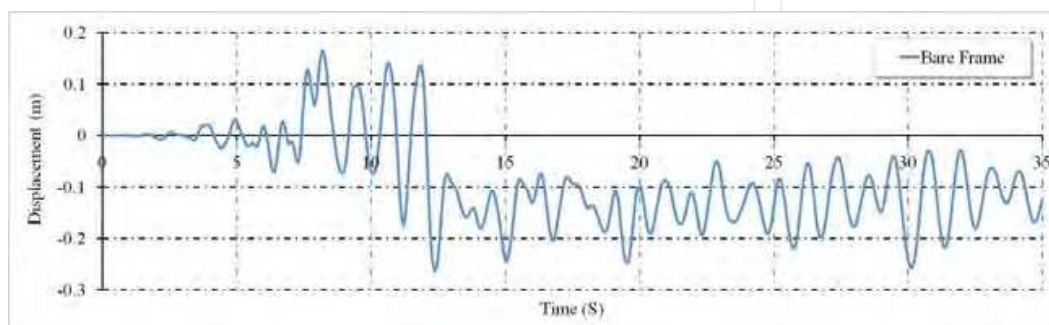

Fig. 18. Time history response for Infilled frame under Loma perita earthquake

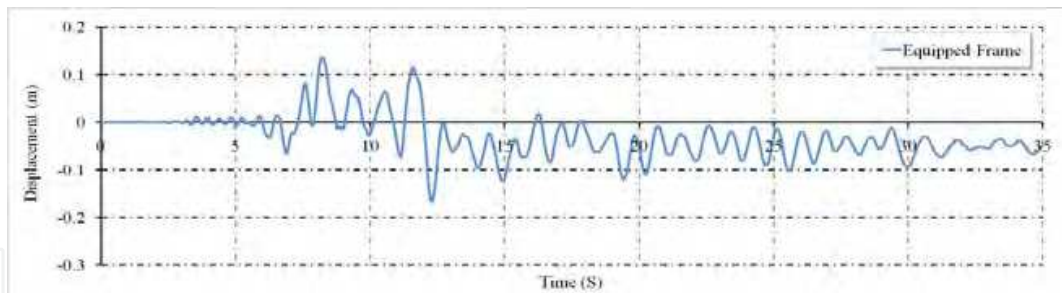

Fig. 19. Time history response for equipped frame under Loma perita earthquake

5.5 Summary and conclusion

Because of high stiffness of the infill walls, considering them as structural elements leads the initial stiffness of structures to increase. Such elements show high strength at the first step of seismic loading, but by reaching to the maximum strength, the infill walls fail and high loss of strength occurs in small drifts. This drop down of strength can be seen in push over curves of the structures. A relatively complete review on the positive and negative effects of masonry infills were presented in a categorized manner. As an example for numerical study torsion produced by infills were discussed as an engineering problem. Existing of these walls causes high differences between a center of mass and center of stiffness. Therefore by applying the lateral forces in center of mass, high torsional torque is generated in the diaphragm. For solving this problem, the FDD is used. Sensitivity analysis on effective variables on the FDD behavior shows that increasing sliding force causes decreasing the differences between the center of mass and center of stiffness, so the problem would be solved. It can be seen that, the FDD modifies structural torsion under earthquake excitation. By increasing PGA the positive effect of FDD in structural behavior is reduced, but equipped structure has better performance related to other structures without FDD. Seismic code requirements are considered. A detailed structural model has been produced using OpenSees. Both static and dynamic nonlinear analyses have been carried out. Because of sensitivity of the friction damper to pulse type excitation, near filed input motion has been considered as excitation force.

6. Acknowledgement

The authors gratefully acknowledge the contribution of Afsaneh Mousavi, graduated student of earthquake engineering, for helping in this research.

7. References

- Aguilar, R. G. (1997). *Efecto del Refuerzo Horizontal en el Comportamiento de Muros de Mampostería Confinada Ante Cargas Laterales*. MSCE. Thesis, Universidad Nacional Autónoma de México.
- Al-Chaar, G. Issa, M. & Sweeney, S. (2002). Behavior of masonry-infilled nonductile reinforced concrete frames, *J. Struct. Eng.*, ASCE 128, 1055-1063.
- Arturo Tena-Colunga, (2010), Review of the Soft First Story Irregularity Condition of Buildings for Seismic Design, *The Open Civil Engineering Journal*, 4, 1-15.

- Atkinson, R.H., Amadei, B.P., Saeb, S. and Sture, S. (1989). Response of Masonry Bed Joints in Direct Shear, *ASCE Journal of Structural Division*, Vol. 115, No. 9, pp. 2276-2296
- Australian Standard, AS 3700–2001, “Masonry Structures “ , prepared by Committee BD-004, published on 27 November 2001
- Baran, M. & Sevil, T. (2010), Analytical and experimental studies on infilled RC Frames , *International Journal of the Physical Sciences* Vol. 5(13), pp. 1981-1998, 18 October
- Basu ,D. & Jain, S. K. (2004), Seismic Analysis of Asymmetric Buildings with Flexible Floor Diaphragms, *Journal of structural engineering*, AUGUST
- Bell, D.K. & Davidson, B.J. (2001), Evaluation of Earthquake Risk Buildings with Masonry Infill Panels, *NZSEE Conference, 2001*
- Bozorgnia1, Y., Tso, W. K. & M. ASCE. (1986), Inelastic earthquake rresponse of asymmetric structures, *Journal of Structural Engineering*, Vol. 112, No. 2, February
- Carydis, P.G. Mouzakis, H.P. Taflambas, J.M. and Vougioukas, E.A. (1992). Response of infilled frames with brickwalls to earthquake motions. *Proceedings of the 10th World Conference on Earthquake Engineering*, Madrid, A.A. Balkema, Rotterdam, Vol. 5, pp. 2829-2834.
- Chrysostomou, C.Z. (1991). *Effect of Degrading Infill Walls on the Nonlinear Seismic Response of Two-Dimensional Steel Frames*, PhD dissertation, Cornell University, Ithaca, N.Y
- Chopra, A.K.& Juan C. De la Llera. (1996). Accidental and natural torsion in earthquake response and design of building, *eleventh word conference on earthquake Engineering*
- Eberhard, M.O., Baldrige, S., Marshall, J. Mooney, W. & Rix, G.J. (2010). The Mw7.0 Haiti earthquake of january 12, 2010: USGS/EERI Advance Reconnaissance Team
- Elnashai, A. S. & Sarno L. D. (2008), *Fundamentals of Earthquake Engineering*, John Wiley & Sons, Ltd. ISBN: 978-0-470-02483-6
- Fardis, M.N. and Calvi, M.C., 1995. Effects of infills on the global response o reinforced concrete frames, *Proceedings of the 10th European Conference on Earthquake Engineering*, Vol. 4, pp.2893-2898.A.A. Balkema, Rotterdam
- Fiorato, A. E., Sozen, M. A. and Gamble, W. L.(1970), An Investigation of the Interaction of Reinforced Frames with Masonry Filler Walls, *Structural Research Series*, No. 370, November ,University of Illinois, Urbana, Illinois, Civil Engineering Studies.
- Gerardo M. Verderame, Flavia De Luca, Paolo Ricci and Gaetano Manfredi. (2010), Preliminary analysis of a soft-storey mechanism after the 2009 L’Aquila earthquake, *Earthquake Engng Struct. Dyn*
- Golafshani, A.A., Bakhshi, A. & Tabeshpour, M.R. (2005). Vulnerability and damage analysis of existin buildings, *Asian Journal of Civil Engineering*, No. 1, 6, 85-100.
- Goodman, R.E.; Taylor, R.L.; Brekke, T.L., (1968). *A model for the mechanics of jointed rock*. ASCE, Div.,94(3), pp. 637-659, USA
- Govindan, P., Lakshmiathy, M., and Sanathkumar, A.R. (1986). Ductility of infilled frames. *American Concrete Institute Journal*, 83: 567 - 576.
- Gur, T., Cihan Pay, A., Ramirez, J. A., Sozen, M. A., Johnson, A. M. & Ayhan Irfanoglu, (2007), Performance of School Buildings in Turkey during the 1999 Düzce and the 2003 Bingöl Earthquakes, *Submitted to Earthquake Spectra*, EERI
- Hendry, A.W. (1990) *Structural Masonry*, Macmillan Education Ltd, London, England.
- Holmes M. (1963). Combined Loading on Infilled Frames, *Proceeding Of The Institution Of Civil Engineers*, Volume 25: 31-38

- Iranian Code of Practice for Seismic Design of Buildings, Standard No. 2800, 3rd Edition, Building and housing research center, 2006
- Ismail, N., Griffith, M. & Ingham J.M. (2011) Performance of masonry buildings during the 2010 Darfield (New Zealand), 11th NAMC
- Junwu, D., Yanru, W., Qingsong, G., Xiaozhai, Q., Xueshan, Y., Mai, T. & Lee, G. C. (2009), Three dimensional temporal characteristics of ground motions and building responses in Wenchuan earthquake, *Earthq Eng & Eng Vib*, 8:287-299
- Kadir M.R.A. (1974). *The structural behavior of masonry infill panels framed structures*, University of Edinburgh, PhD thesis
- Kappos, A.J. Stylianidis, K.C. and Michailidis, C.N. (1998). Analytical models for brick masonry infilled r/c frames under lateral loading. *Journal of Earthquake Engineering*, Vol. 2(1), pp. 59-87
- King G.J.W. & Pandey P.C. (1978). The analysis of infilled frames using finite elements. *Proc. Instn Civ. Engrs*, Part 2, 65, 749-760
- Klingner, R.E. Rubiano, N.R. Bashandy, T.R. & Sweeney, S.C. (1996). Evaluation and Analytical Verification of Shaking Table Data from Infilled Frames, Part 2: Out-of-Plane Behavior, *Proceedings of the 7th North American Masonry Conference*, Notre Dame.
- Klinger, R.E. & Bertero, V.V. (1976). *Infilled frames in earthquake resistant construction*. Earthquake Engineering Research Center, University of California, Berkeley, CA, Rep. EERC 76-32, Dec
- Komachi, Y. Tabeshpour, M.R. & Mualla, I. & Golafshani, A.A. (2011). Retrofit of Ressalat Jacket Platform (Persian Gulf) using Friction Damper Device. *Journal of Zhejiang University*, in press
- Koset, E.G. et al. (1974). Non-linear dynamic analysis of frames with filler panels, *Am. Soc. Civ. Engrs*, J. struct. Div., 100, 743-757
- Kwon, O. (2008). Damaging Effects of the Pisco-Chincha (Peru) Earthquake on an Irregular RC Building, *The 14th World Conference on Earthquake Engineering* October 12-17, Beijing, China 2008
- Lili Anne Akin. (2004). behavior of reinforced concrete frames with masonry infills in seismic regions. PHD Thesis in Purdue University
- Liau, T.C. & Kawn, K.H. (1984). New Development in Research of Infilled Frames, *Proc. 8th World Conf. on Earthq. Engng*, San Francisco, 4, 623-630
- Mainstone, R. J. (1971). *On the stiffness and strengths of infilled frames*, *Proceedings, Institution of Civil Engineers*, Supplement IV, 57-90
- Mallick D.V. & Severn R.T. (1967). *The Behavior of Infilled Frames under Static Loading*, The Institution of Civil Engineers, *Proceedings*, 39, 639-656
- Mallick, D. V. & Garg, R. P. (1971). *Effect of openings on the lateral stiffness of infilled frames*, *Proceedings of the Institution of Civil Engineers* 49, 193-209
- Manos, G.C. Triamataki, M. & Yasin, B. (1995). Experimental and numerical simulation of the influence of masonry infills on the seismic response of reinforced concrete framed structures. *Proceedings of the 10th European Conference on Earthquake Engineering*, A.A. Balkema, Rotterdam, Vol. 3, pp. 1513-1518.
- Marjani, F. & Ersoy, U. Behavior of Brick Infilled Reinforced Concrete Frames Under Reversed Cyclic Loading. 06/23/2004.

- Mehrabi, A. B., Shing, P. B., Schuller, M.P. and Noland, J.L. (1996). Experimental Evaluation of Masonry-Infilled RC Frames. *ASCE Journal of Structural Engineering*, Vol. 122, No. 3, pp. 228-237.
- Mehrabi, A. B., and Shing, P. B. (1998). Seismic Resistance of Masonry- Infilled RC Frames. *Proceedings of the 8th North American Masonry Conference*, The Masonry Society, USA, pp. 465-476.
- Michailidis, K., Sklavounos, S., and Plimer, I. (1995). Chromian dravite from the chromite ores of Vavdos area, Chalkidiki peninsula, Northern Greece. *Neues Jahrbuch fur Mineralogie. Monatshefte*, 1995, 513-528.
- Moehle, J. P., Elwood, K. J. & Sezen, H., Shear strength and axial load collapse of existing reinforced concrete columns
- Moghadam, Hasan. (2001). Earthquake Engineering, Basic and Application Seismic design of buildings-2800 code. 3. S.I:Building and housing research center
- Mohyeddin-Kermani, A. et al. (n.d).The Behaviour of RC Frames with Masonry Infill in Wenchuan Earthquake
- Mosalam, K.M., White, R.N., & Gergely, P. (1997). Static Response of Infilled Frames using Quasistatic Experimentation. *ASCE Journal of Structural Engineering*, Vol. 123, No. 11, pp. 1462-1469.
- Mualla, IH, Belev B. Performance of steel frames with a new friction damper device under earthquake excitation, *Engineering Structures*, 24 (2002) 365-371
- Naseer, A. et al. (2007). Building code of Pakistan: before and after the October 08, 2005 Kashmir earthquake, *Sixth National Conference on Earthquake Engineering*, 16-20 October, Istanbul, Turkey.
- Negro P. and Verzeletti G. (1996). Effect of Infills on the Global Behaviour of R/C Frames: Energy Considerations from Pseudodynamic Tests. *Earthquake Engineering and Structural Dynamics*, 25, 753-773
- Nevzat, Kirac. Mizam, Dogan, Hakan, Ozbasaran. (2010). Failure of weak-storey during earthquakes, *Engineering Failure Analysis*
- Paulay, T. & Priestley, M.J.N. (1992). *Seismic Design of Reinforced Concrete and Masonry Buildings*, John Wiley & Sons, New York, United States
- Paulay, T. & Priestley, M. J. N. (1992). *Seismic Design of Reinforced Concrete and Masonry Buildings*”, John Wiley & Sons, Inc
- Polyakov, S. V. (1956). *Masonry in Framed Buildings (An investigation into the strength and stiffness of masonry infilling)*, Moscow.
- Pires, F. & Carvalho, E.C. (1992). The behaviour of infilled reinforced concrete frames under horizontal cyclic loading. *Proceedings of the 10th World Conference on Earthquake Engineering*, Madrid, A.A. Balkema, Rotterdam, Vol. 6, pp. 3419-3422.
- Rivero C.E. & Walker W.H. (1984), An Analytical Study of The Interaction of Frames and Infill Masonry Walls, *Proc. 8th World Conf. on Earthq. Engng.*, San Francisco, 4, 591-598.
- Sahlin, S. (1971). *Structural Masonry*, Prentice-Hall Inc., New Jersey, United States.
- San Bartolomé, A. (1990). *Collección del Ingeniero Civil*, (in Spanish), Libro No. 4, Colegio de Ingenieros del Peru.E
- Santiago, P. Amadeo, B.C. Mario, E. R. and Paul Smith-Pardo, J. masonry infill walls: an effective alternative for seismic strengthening of low-rise reinforced concrete

- building. *The 14th World Conference on Earthquake Engineering* October 12-17, 2008, Beijing, China
- Schneider, S.P. Zagers, B.R. and Abrams, D.P. (1998). Lateral strength of steel frames with masonry infills having large openings. *ASCE Journal of Structural Engineering*, Vol. 124(8), pp. 896-904.
- Sezen, H. Moehle, J. P, (2006), Seismic Test of Concrete Columns With Light Transverse Reinforcement, *ACI Structural Journal*, V.103, No.6, November-December
- Sharany Haque & Khan Mahmud Amanat. (2009), Strength and drift demand of columns of RC framed buildings with soft ground story, *Journal of Civil Engineering (IEB)*, 37 (2) (2009) 99-110
- Shing, P. B. & Mehrabi, A. B. (2002). Behaviour and analysis of masonry-infilled frames, *Progress in Structural Engineering and Materials*, 4(3), 320-331.
- Shrive, N.G. (1991). Materials and Material Properties, *Reinforced and Prestressed Masonry*, A.W.Hendry, Longman Scientific and Technical, London, England
- Siamak Sattar & Abbie B. Liel, (n.d), Seismic performance of reinforced concrete frame structures with and without masonry infill walls
- Sinha, B.P. & Pedreschi, R. (1983). Compressive Strength and Some Elastic Properties of Brickwork, *International Journal of Masonry Construction*, Vol. 3, No. 1, pp. 19-27.E
- Smith, B. S. & Coull, A. (1991), *Tall Building Structures: Analysis and Design*, John Wiley & Sons, Inc
- Stafford-Smith B.S. (1968). Model Test Results of Vertical and Horizontal Loading of Infilled Frames, *ACI Journal*, Volume 65, No. 8: 618-625
- Stefano, Ma. D. & Pintucchi, B. (2007), *A review of research on seismic behaviour of irregular building structures since 2002*, Springer Science+Business Media B.V. 2007.
- Stöckl, S. & Hofmann, P. (1988). Tests on the Shear Bond Behaviour in the Bed-joints of Masonry, *Proceedings of the 8th International Brick and Block Masonry Conference*, Dublin, Ireland.
- Tabeshpour, M. R. Ghanad, M. A. Bakhshi, A. & Golafshani, A. A. (2004). Effect of masonry infills on seismic behavior of concrete frames, *1th national conference of civil engineering*, sherriff University, Tehran, Iran.
- Tabeshpour, M. R. (2005). Numerical study of short column failure, *Earthquake research letters*, IISEE, Tehran, Iran.
- Tabeshpour, M.R. (2009a). *Masonry infills in structural frames (Handbook, Part 18)*, FadakIssatis Publisher, Tehran, Iran.
- Tabeshpour, M.R. (2009b). *Seismic retrofit of infilled frames (Handbook, Part 19)*, Fadak Issatis Publisher, Tehran, Iran.
- Tabeshpour, M. R. (2009c). *Requirements of infills in Iranian seismic code of practice, Standard No. 2800 (Handbook, Part. 20)*, Fadak Issatis Publisher, Tehran, Iran.
- Tabeshpour, M. R. (2009d) A comparative study of several codes about masonry infill wall, *4th national conference of seismic design code of buildings (standard No. 2800)*, Tehran, Iran.
- Tabeshpour, M. R. (2009e) Modeling of infill wall using commercial software, *4th national conference of seismic design code of buildings (standard No. 2800)*, Tehran, Iran.
- Tabeshpour, M. R. (2009f) Increasing design load in specific columns, *4th national conference of seismic design code of buildings (standard No. 2800)*, Tehran, Iran.

- Tabeshpour, M.R. Ebrahimian, H. (2010). Seismic retrofit of existing structures using friction dampers, *Asian Journal of Civil Engineering*, No. 4, 11, 509-520.
- Tabeshpour, M. R. Azad, A., & Golafshani, A. A. (2011a). Nonlinear static analysis of steel frame with asymmetric arrangement of masonry infill wall, *3rd national conference of urban management and retrofitting*, Tehran, Iran.
- Tabeshpour, M. R. Mousavy, A. (2011b). Short column surveying because of masonry infill wall existence using nonlinear static analysis, *6th national conference of civil engineering*, semnan, Iran.
- Tabeshpour, M.R. Azad, A. Golafshani, A.A. (2011c). Seismic Retrofitting by using Friction damper in Horizontally Irregular Infilled Structures, *6th National Congress on Civil Engineering*, Semnan University, Semnan, Iran.
- Tabeshpour, M. R. Kalatjari, V.R. & Karimi, K. (2011d), Investigation of lateral drift of concrete infilled frames, *1st National conference on earthquake and lifelines*, Tehran, Iran.
- Takewaki, I.; Murakami, S. & Fujita, K. & Yoshitomi, S. & Tsuji, M. (2011). The 2011 off the Pacific coast of Tohoku earthquake and response of high-rise buildings under long-period ground motions, *Soil Dynamics and Earthquake Engineering*, In Press
- Tso, W.K. (1988), Strength eccentricity concept for inelastic analysis of asymmetrical structures, *Eng. Struct.* 1989, Vol. 11
- Tso, W. K. & Ying, H. (1992), Lateral strength distribution specification to limit additional inelastic deformation of torsionally unbalanced structures, *Eng. Struct.* Vol. 14, No 4, July
- Valiasis, T. Stylianidis, K. (1989). Masonry Infilled R/C Frames under Horizontal Loading experimental Results. *European Earthquake Engineering*, Vol. 3, No. 3, pp. 10-20
- Valiasis, T.N. Stylianidis, K.C. and Penelis, G.G. (1993). Hysteresis model for weak brick masonry infills in R/C frames under lateral reversals. *European Earthquake Engineering*, Vol. 7(1), pp. 3-9.
- Yoon, Y. & Stafford Smith, B. (1995), Assessment of translational-torsional coupling in asymmetric uniform wall-frame structures, *Journal of structural engineering*, October
- Zarnic, R. (1994). Inelastic Model of R/C Frame with Masonry Infill – Analytical Approach. *Engineering Modelling*, 1-2, 47-54.
- Zarnic, R. & Tomazevic, M. (1985). Study of Behaviour of Masonry Infilled Reinforced Concrete Frames Subjected to Seismic Loading. *Proc. 7th International Brick Masonry Conference*, Brick Dev. Res. Inst. & Dept. of Arch. And Bldg., University of Melbourne, 2, 1315-1325.
- Zarnic, R. Gostic, S. (1998). Non Linear Modelling of Infilled Frames. *11th European Conference Earthquake Engineering*, Paris, Balkema: Rotterdam.

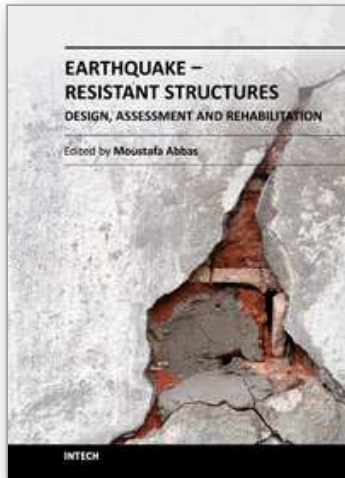

Earthquake-Resistant Structures - Design, Assessment and Rehabilitation

Edited by Prof. Abbas Moustafa

ISBN 978-953-51-0123-9

Hard cover, 524 pages

Publisher InTech

Published online 29, February, 2012

Published in print edition February, 2012

This book deals with earthquake-resistant structures, such as, buildings, bridges and liquid storage tanks. It contains twenty chapters covering several interesting research topics written by researchers and experts in the field of earthquake engineering. The book covers seismic-resistance design of masonry and reinforced concrete structures to be constructed as well as safety assessment, strengthening and rehabilitation of existing structures against earthquake loads. It also includes three chapters on electromagnetic sensing techniques for health assessment of structures, post earthquake assessment of steel buildings in fire environment and response of underground pipes to blast loads. The book provides the state-of-the-art on recent progress in earthquake-resistant structures. It should be useful to graduate students, researchers and practicing structural engineers.

How to reference

In order to correctly reference this scholarly work, feel free to copy and paste the following:

Mohammad Reza Tabeshpour and Amir Azad (2012). Seismic Behavior and Retrofit of Infilled Frames, Earthquake-Resistant Structures - Design, Assessment and Rehabilitation, Prof. Abbas Moustafa (Ed.), ISBN: 978-953-51-0123-9, InTech, Available from: <http://www.intechopen.com/books/earthquake-resistant-structures-design-assessment-and-rehabilitation/seismic-design-and-retrofit-of-infilled-frames>

INTECH
open science | open minds

InTech Europe

University Campus STeP Ri
Slavka Krautzeka 83/A
51000 Rijeka, Croatia
Phone: +385 (51) 770 447
Fax: +385 (51) 686 166
www.intechopen.com

InTech China

Unit 405, Office Block, Hotel Equatorial Shanghai
No.65, Yan An Road (West), Shanghai, 200040, China
中国上海市延安西路65号上海国际贵都大饭店办公楼405单元
Phone: +86-21-62489820
Fax: +86-21-62489821

© 2012 The Author(s). Licensee IntechOpen. This is an open access article distributed under the terms of the [Creative Commons Attribution 3.0 License](#), which permits unrestricted use, distribution, and reproduction in any medium, provided the original work is properly cited.

IntechOpen

IntechOpen