

We are IntechOpen, the world's leading publisher of Open Access books Built by scientists, for scientists

4,800

Open access books available

122,000

International authors and editors

135M

Downloads

Our authors are among the

154

Countries delivered to

TOP 1%

most cited scientists

12.2%

Contributors from top 500 universities



WEB OF SCIENCE™

Selection of our books indexed in the Book Citation Index
in Web of Science™ Core Collection (BKCI)

Interested in publishing with us?
Contact book.department@intechopen.com

Numbers displayed above are based on latest data collected.
For more information visit www.intechopen.com



Adaptable PID Versus Smith Predictive Control Applied to an Electric Water Heater System

José António Barros Vieira¹ and Alexandre Manuel Mota²

¹*Polytechnic Institute of Castelo Branco, School of Technology of Castelo Branco,
Department of Electrical and Industrial Engineering,*

²*University of Aveiro,
Department of Electronics Telecommunications and Informatics,
Portugal*

1. Introduction

Industry control processes presents many challenging problems, including non-linear or variable linear dynamic behaviour, variable time delay that means time varying parameters. One of the alternatives to handle with time delay systems is to use prediction technique to compensate the negative influence of the time delay. Smith predictor control (SPC) is one of the simplest and most often used strategies to compensate time delay systems. In this algorithm it is important to choose the right model representation of the linear/non-linear system. The model should be accurate and robust for all working points, with a simple mathematical and transparent representation that makes it interpretable.

This work is based in a previews study made in modelling and controlling a gas water heater system. The problem was to control the output water temperature even with water flow, cold water temperature and desired hot water temperature changes. To succeed in this mission one non-linear model based Smith predictive controller was implemented. The main study was to identify the best and simple model of the gas water heater system.

It has been shown that many variable industry linear and non-linear processes are effectively modelled with neural and neuro-fuzzy models like the chemical processes (Tompson & Kramer, 1994). Hammerstein and Wiener models like pH-neutralization, heat exchangers and distillation columns (Pottman & Pearson, 1992), (Eskinat et al., 1991). And hybrid models like heating and cooling processes, fermentation (Psichogios & Ungar, 1992), solid drying processes (Cubillos et al., 1996) and continues stirred tank reactor (CSTR) (Abonyi et al., 2002).

In this previews work there were explored this three different modelling types: neuro-fuzzy (Vieira & Mota, 2003), Hammerstein (Vieira & Mota, 2004) and hybrid (Vieira & Mota, 2005) and (Vieira & Mota, 2004a) models that reflex the evolution of the knowledge about the first principles of the system. These kinds of models were used because the system had a non-linear actuator, time varying linear parameters and varying dead time systems. For dead time systems some other sophisticated solutions appear like in (Hao, Zouaoui, et al., 2011)

that used a neuro-fuzzy compensator based in Smith predictive control to achieved better results. Or other solutions for unknown dead time delays like (Dong-Na, Guo, et al., 2008) that use gray predictive adaptive Smith-PID control because the dead time variation is unknown. There is an interesting solution to control processes with variable time delay using EPSAC (Extended Prediction Self-Adaptive Control) (Sbarciog, Keyser, et al., 2008) that could be used in this systems because the delay variations is caused by fluid transportation.

At the beginning there was no knowledge about the physical model and there were used black and grey box model approaches. Finally, the physical model was found and a much simple adaptive model was achieved (the physical model white box modelling).

This chapter presents two different control algorithms to control the output water temperature in an electric water heater system. The first approach is the adaptive proportional integral derivative controller and second is the Smith predictive controller based on the physical model of the system. From the previews work it is known that the first control approach is not the best algorithm to use in this system, it was used just because it has a simple mathematical structure and serves to compare results with the Smith predictive controller results. The Smith predictive controller has a much more complex mathematical structure because it uses three internal physical models (one inverse and two directs) and deals with the variable time delay of the system. The knowledge of the physical model permits varying the linear parameters correctly in time and gives an interpretable model that facilitate its integration on any control schemes.

This chapter starts, in section 2, with a full description of the implemented system to control the electric water heater, including a detailed description of the heater and its physical equations allowing the reader to have a comprehension of the control problems that will be explained in later sections.

Section 3 and 4, describes the two control algorithms presented: the adaptive proportional integral derivative control structure and the Smith predictive control based in the physical models of the heater. These sections show the control results using the two approaches applied in to a domestic electric water heater system. Finally, in section 5, the conclusions are presented.

2. The electric water heater

The overall system has three main blocks: the electric water heater, a micro-controller board and a personal computer (see figure 1).

The micro-controller board has two modules controlled by a flash-type micro-controller from the ATMEL, ATMEGA168 with 8Kbytes on FLASH. The interface module has the necessary electronics to connect the sensors and control the actuator. The communication module has the RS232 interface used for monitoring and acquisition of all system variables in to a personal computer.

After this small description of the prototype system, the electric water heater characteristics are presented and its first principles equations are presented.

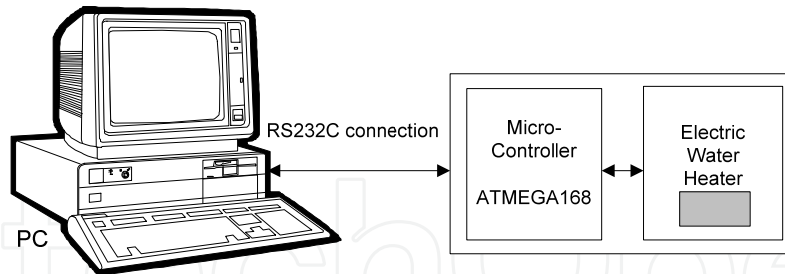

Fig. 1. System main blocks.

2.1 Electric water heater description

The electric water heater is a multiple input single output (MISO) system. The controlled output water temperature will be called hot water temperature ($hwt(t)$). This variable depends of the cold water temperature ($cwt(t)$), water flow ($wf(t)$), power ($p(t)$) and of the electric water heater dynamics. The hot and cold water temperature difference is called delta water temperature ($\Delta t(t)$).

The electric water heater is physically composed by an electric resistance, a permutation chamber and several sensors used for control and security of the system as shown on figure 2.

Operating range of the $hwt(t)$ is from 20 to 50°C. Operating range of the $cwt(t)$ is from 5 to 25°C. Operating range of the $wf(t)$ is from 0,5 to 2,5 liters / minute. Operating range of the $p(t)$ is from 0 to 100% of the available power.

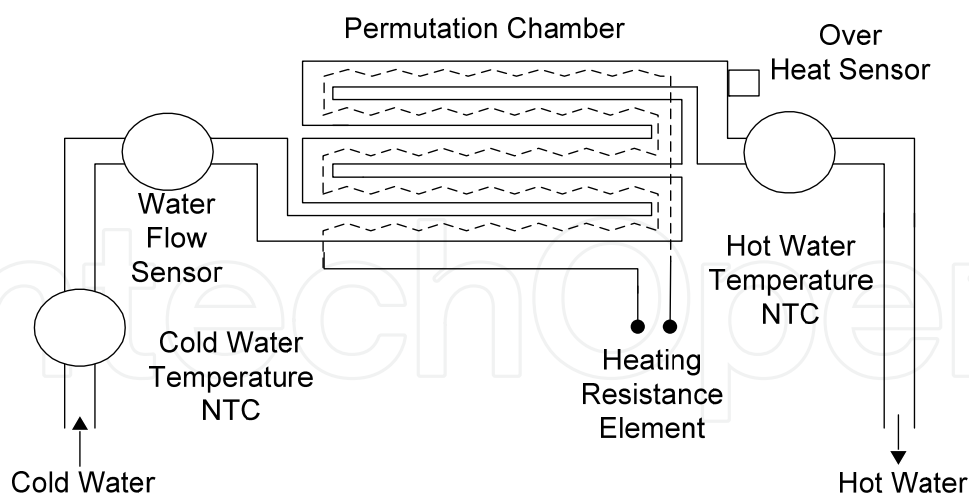

Fig. 2. Schematic of the electric water heater: sensors and actuator.

The applied energy in to the heating resistance is controlled using 100 alternated voltage cycles (one second). In each sample, the applied number of cycles is proportional to the delivery energy to the heating element.

Figure 3 shows one photo of the electric water heater and the micro-controller board.

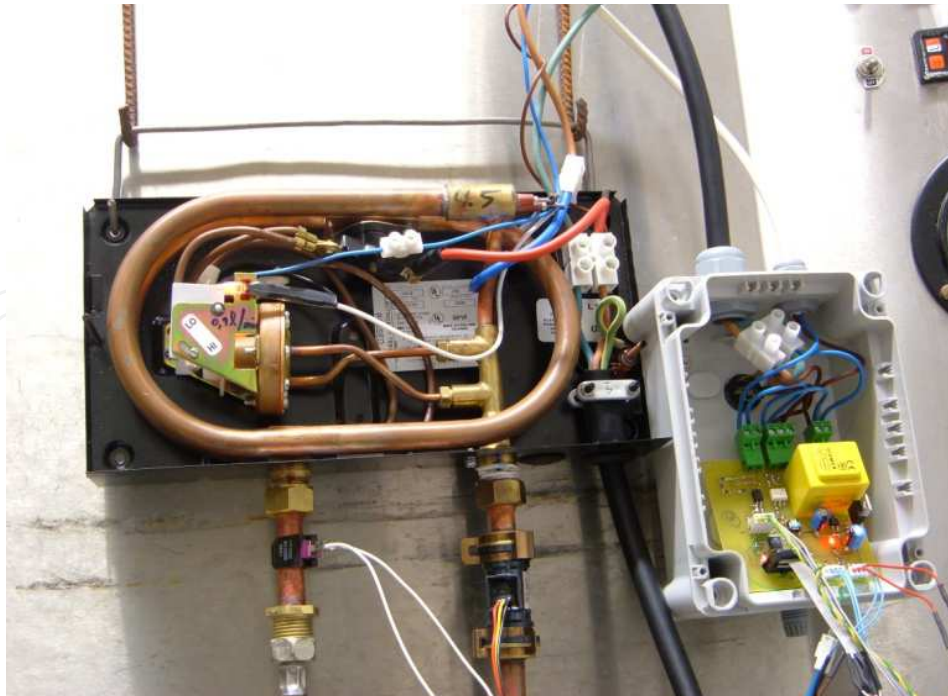

Fig. 3. Photo of the electric water heater and the micro-controller board.

2.2 Electric water heater first principles equations

Applying the principle of energy conservation in the electric water heater system, equation 1 could be written. This equation was based in a previous work made in modelling a gas water heater system, first time presented in [11].

$$\frac{dEs(t)}{dt} = Qe(t - td) - wf(t)hwt(t)Ce - wf(t)cwt(t)Ce \quad (1)$$

Where $dEs(t)/dt = M Ce (d\Delta t(t)/dt)$ is the energy variation of the system in the instant t , $Qe(t)$ is the calorific absorbed energy, $wf(t)cwt(t)Ce$ is the input water energy that enters in the system, $wf(t)hwt(t)Ce$ is the output water energy that leaves the system, and Ce is the specific heat of the water, M is the water mass inside of the permutation chamber and td is the variable system time delay.

The time delay of the system has two parts: a fixed one that became from the transformation of energy and a variable part that became from the water flow that circulates in the permutation chamber.

M is the mass of water inside of the permutation chamber (measured value of 0,09Kg) and Ce is the specific heat of the water (tabled value of 4186 J/(KgK)). The maximum calorific absorbed energy $Qe(t)$ is proportional to the maximum electric applied power of 5,0 KW.

The absorbed energy $Qe(t)$ is proportional to the applied electric power $p(t)$. On each utilization of the water heater it was considered that $cwt(t)$ is constant, it could change from utilization to utilization, but in each utilization it remains approximately constant. Its dynamics does not affect the dynamics of the output energy variation because its variation is too slow.

Writing equation 1 in to the Laplace domain and considering a fixed water flow $wf(t) = Wf$ and fixed time delay td , it gives equation 2.

$$\frac{\Delta t(s)}{Qe(s)} = \frac{\frac{1}{WfCe}}{\frac{M}{Wf}s+1} e^{-s td} = \frac{\frac{1}{WfCe} \frac{Wf}{M}}{s + \frac{Wf}{M}} e^{-s td} \quad (2)$$

Passing to the discrete domain, with a sampling period of $h=1$ second and with discrete time delay $\tau d(k) = \text{int}\left(\frac{td(t)}{h}\right) + 1$, the final discrete transfer function is illustrated in equation 3.

$$\Delta t(k+1) = \left(e^{-\frac{Wf}{M}} \right) \Delta t(k) + \left(\frac{1}{WfCe} \left(1 - e^{-\frac{Wf}{M}} \right) \right) (Qe(k - \tau d(k))) \quad (3)$$

The real discrete time delay $\tau d(k) = \tau d_1(k) + \tau d_2(k)$ is given in equation 4, where $\tau d_1(k) = 3s$ is the fixed part of $\tau d(k)$ that became from the transformation of energy $\tau d_2(k)$ and is the variable part of $\tau d(k)$ that became from the water flow $wf(k)$ that circulates in the permutation chamber.

$$\tau d(k) = \begin{cases} 4 & \text{to } wf(k) \geq 1,75l / \text{min} \\ 5 & \text{to } 1,00l / \text{min} < wf(k) < 1,75l / \text{min} \\ 6 & \text{to } wf(k) \leq 1,00l / \text{min} \end{cases} \quad (4)$$

Considering now the possibility of changes in the water flow, in the discrete domain $Wf = wf(k)$ and $\tau d_2(k)$, the final transfer function is given in equation 5.

$$\Delta t(k+1) = \left(e^{-\frac{wf(k - \tau d_2(k))}{M}} \right) \Delta t(k) + \left(\frac{1}{wf(k - \tau d_2(k))Ce} \left(1 - e^{-\frac{wf(k - \tau d_2(k))}{M}} \right) \right) (Qe(k - \tau d(k))) \quad (5)$$

Observing the real data of the system, the absorbed energy $Qe(t)$ is a linear static function $f(\cdot)$ proportional to the applied electric power $p(t)$ as expressed in equation 6.

$$Qe(k - \tau d(k)) = f(p(k - \tau d(k))) \quad (6)$$

Finally, the discrete global transfer function is given by equation 7.

$$\Delta t(k+1) = \left(e^{-\frac{wf(k - \tau d_2(k))}{M}} \right) \Delta t(k) + \left(\frac{1}{wf(k - \tau d_2(k))Ce} \left(1 - e^{-\frac{wf(k - \tau d_2(k))}{M}} \right) \right) (f(p(k - \tau d(k)))) \quad (7)$$

If $A(k)$ and $B(k)$ are defined as expressed in equation 8, the final discrete transfer function is given as defined in equation 9.

$$A(k) = e^{-\frac{wf(k-\tau d_2(k))}{M}} \quad (8)$$

$$B(k) = \frac{1}{wf(k-\tau d_2(k))Ce} \left(1 - e^{-\frac{wf(k-\tau d_2(k))}{M}} \right) \quad (8)$$

$$\Delta t(k+1) = A(k)\Delta t(k) + B(k)(f(p(k-\tau d(k)))) \quad (9)$$

2.3 Physical model validation

For validation of the presented discrete physical model, it is necessary to have open loop data of the real system. This data has been chosen to respect two important requirements: frequency and amplitude spectrum wide enough (Psichogios & Ungar, 1992). Respecting the necessary presupposes, the collect data is made via RS232 connection to the PC. The validation data and the physical model error are illustrated in figure 4.

Figure 4 shows the physical model error signal $e(k)$, which is equal to the difference between delta and estimated delta water temperature $e(k) = \Delta t(k) - \Delta t_{estimated}(k)$. It can be seen from this signal, that the proposed model achieved very good results with a mean square error (MSE) of $1,32^{\circ}\text{C}^2$ for the all test set (1 to 1600).

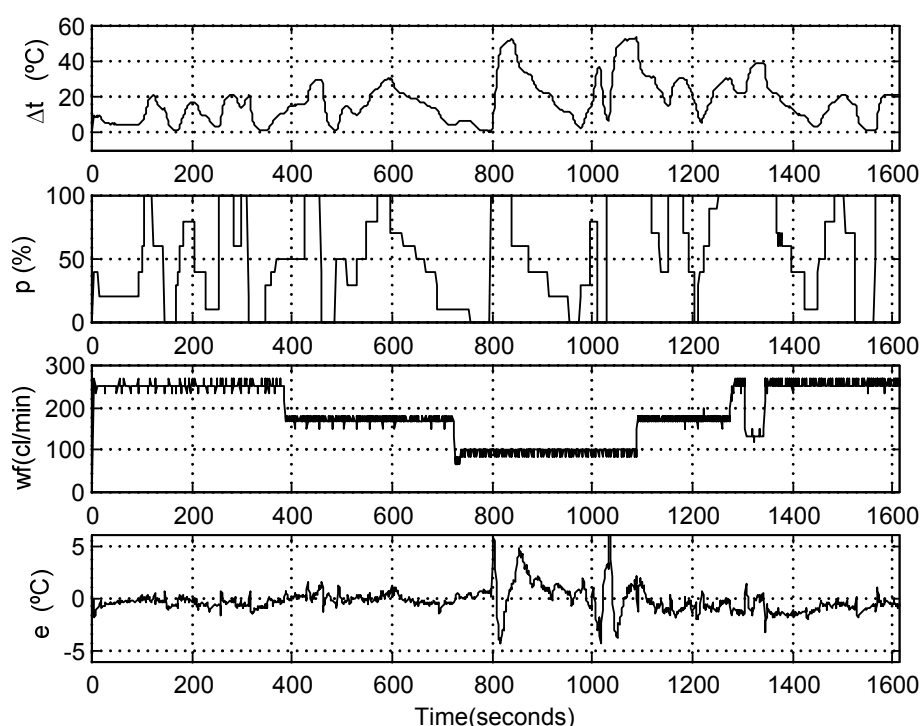

Fig. 4. Open loop data used to validate the model.

From the validation test, figure 5 shows the two linear variable parameters expressed in equation 8 of the physical model used.

As can be seen the $A(k)$ parameter that multiply with the regressor delta water temperature changes significantly with water flow $wf(k)$ and the $B(k)$ parameter that multiply with the regressor applied power $f(p(k - \tau d(k)))$ presents very small changes with the water flow $wf(k)$.

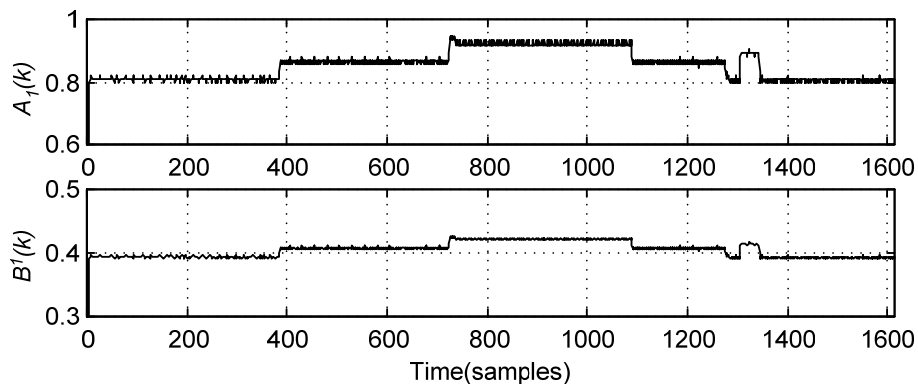

Fig. 5. The two linear variable parameters $A(k)$ and $B(k)$.

From the results it can be seen that for the small water flows the model presents a bigger error signal. This happens because of the small resolution of the water flow measurements and of the estimated integer time delays forced (a multiple of the sampling time h it is not possible fractional time delays).

3. Adaptive PID controller

The first control loop tested is the adaptive proportional integral derivative control algorithm. Adaptive because we know that gain and time constant of the system changes with the input water flow. First it is described the control structure and its parameters and second the real control results are showed.

3.1 Adaptive PID control structure

This is a very simple and well known control strategy that has two control parameters K_p and K_d that are multiplied by the water flow, as illustrated in figure 6. The applied control signal is expressed in equation 10:

$$f(p(k)) = f(p(k-1)) + wf(k)K_p e(k) + wf(k)K_d(e(k) - e(k-1)) \quad (10)$$

The P block gives the error proportional contribution, the D block gives the error derivative contribution and the I block gives the control signal integral contribution.

The three control parameters were adjusted after several experimental tests in controlling the real system. This algorithm has some problems dealing with time constant and time delay variations of the system. With this control loop it is not possible to define a close loop

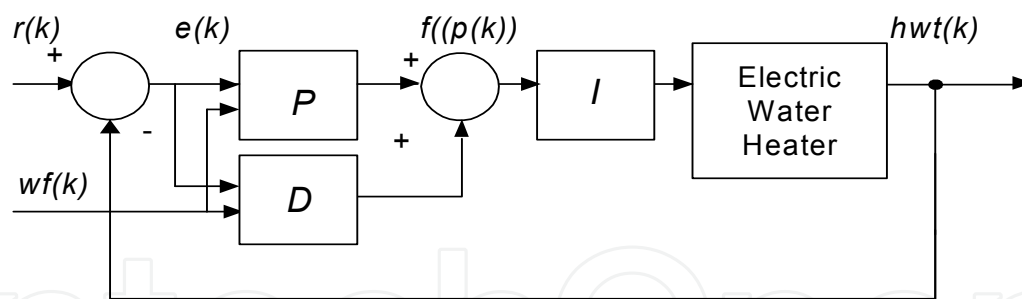

Fig. 6. APID controller constituent blocks.

system with a fixed time constant. The time delay is also a problem that is not solved with this control algorithm.

It was define a reference signal $r(t)$ that is the desired hot water temperature and a water flow $wf(t)$ with several step variations similar to the ones used in real applications. The cold water temperature was almost constant around 13,0 °C.

For testing the controllers it can be seen that error signal $e(t)=r(t)-hwt(t)$ is around zero excepted in the input transitions. In reference step variations it can be seen that the overshoots for the different water flows are similar but the rise times are clearly different, for small water flows the controller presets bigger rise times. In water flow variations the control loop have some problems because of the variable time delay. This control loop only reacted when error appears.

3.2 Adaptive PID control results

With the proposed tests signals, the tuned adaptive PID control structure was tested in controlling the electric water heater. The APID control results are shown in figure 7.

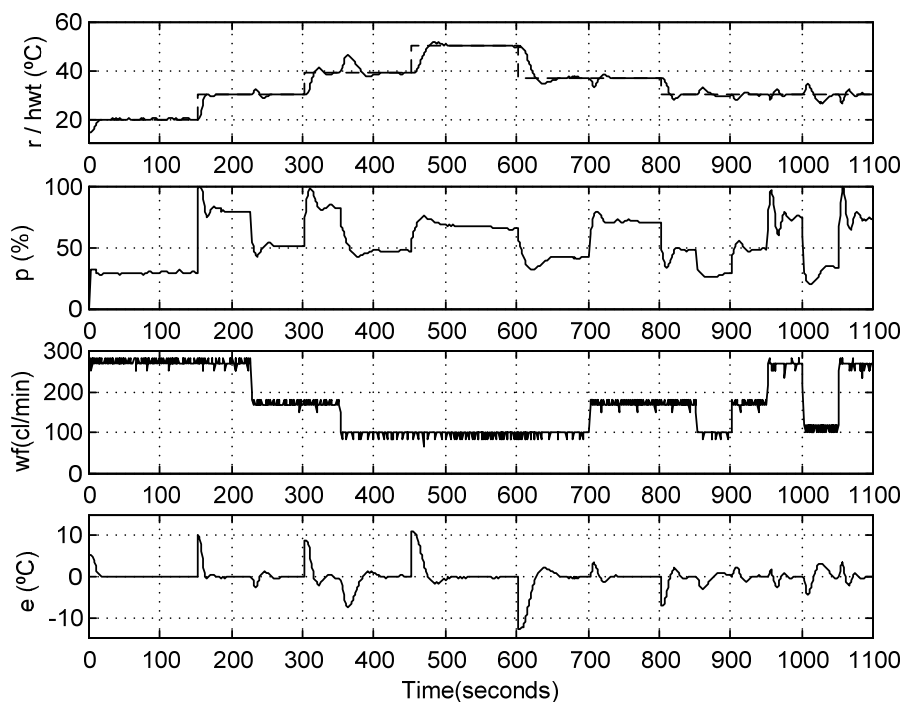

Fig. 7. Adaptive PID control results.

As it was predicted the results have shown some problems in water flow variations because the controller just reacts when it feels an error signal different from zero.

The evaluation control criterion used is the mean square error (MSE). The MSE in the all test is presented in table 1.

Algorithm	MSE Test Set
APID	5,97

Table 1. Mean square errors of the control results.

4. Smith predictive controller

The second control loop tested is the Smith predictive control algorithm. This control strategy is particularly used to control systems with time delay. First it is described the control structure and its parameters and second the control results are showed.

4.1 Smith predictive control structure

The Smith predictive controller is based in the internal model controller architecture that uses the physical model presented in section II, as illustrated in figure 8. It uses two physical direct models one with time delay for the prediction loop and another with out the time delay for the internal model control structure.

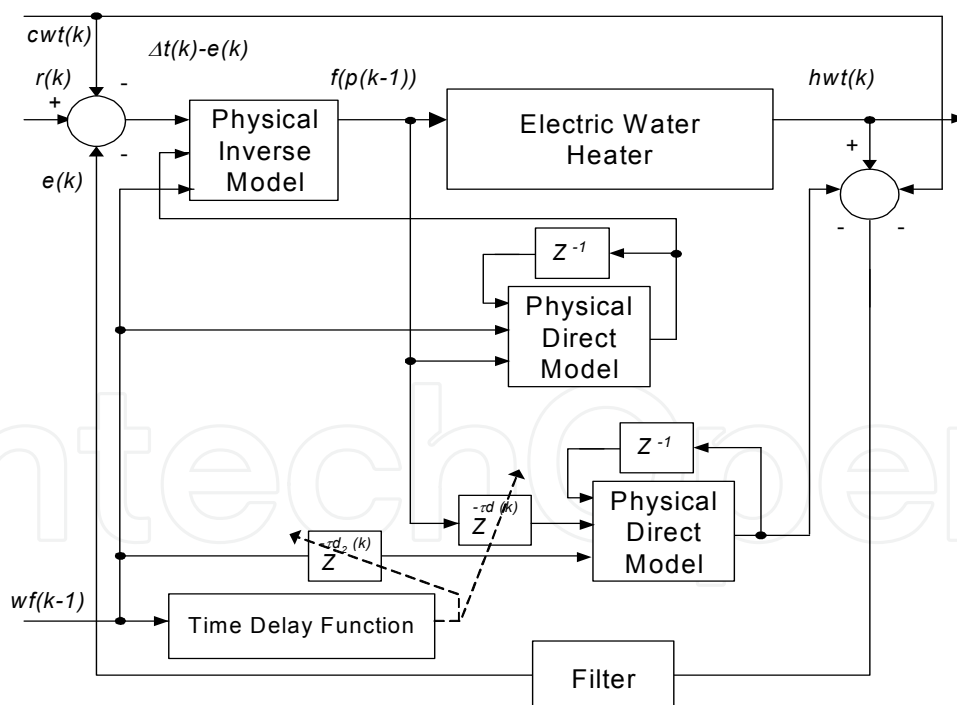

Fig. 8. SPC constituent blocks.

The Smith predictive control structure has a special configuration, because the systems has two inputs with two deferent time delays so it uses two direct models, one model with time delay for compensate its negative effect and another with out time delay needed for the internal model control structure.

The SPC separates the time delay of the plant from time delay of the model, so it is possible to predict the $\Delta t(k)$, $\tau d(k)$ steps earlier, avoiding the negative effect of the time-delay in the control results. The time delay is a known function that depends of the water flow $wf(k)$. The incorrect prediction of the time delay may lead to aggressive control if the time delay is under estimated or conservative control if the time delay is over estimated (Tan & Nazmul Karim, 2002), (Tan & Cauwenberghe, 1999).

The physical inverse model is mathematically calculated based in the physical direct model presented in section 2 used with out time delay.

The low pass filter used in the error feedback loop is a digital first order filter used to filter the feedback error and indirectly to filter the control signal $f(p(k))$. The time delay function is a function of the water flow, which is explained in section 2 and expressed in equation 4.

To test the SPC based in the physical model it was used the same reference signals $r(t)$ and water flow $wf(t)$ used to test the adaptive PID controller.

4.2 Smith predictive control results

The SPC results are shown in figure 9. As it was predicted from previews work the results are very good in reference and in water flow changes. The behaviour of the closed loop system is very similar in every working point.

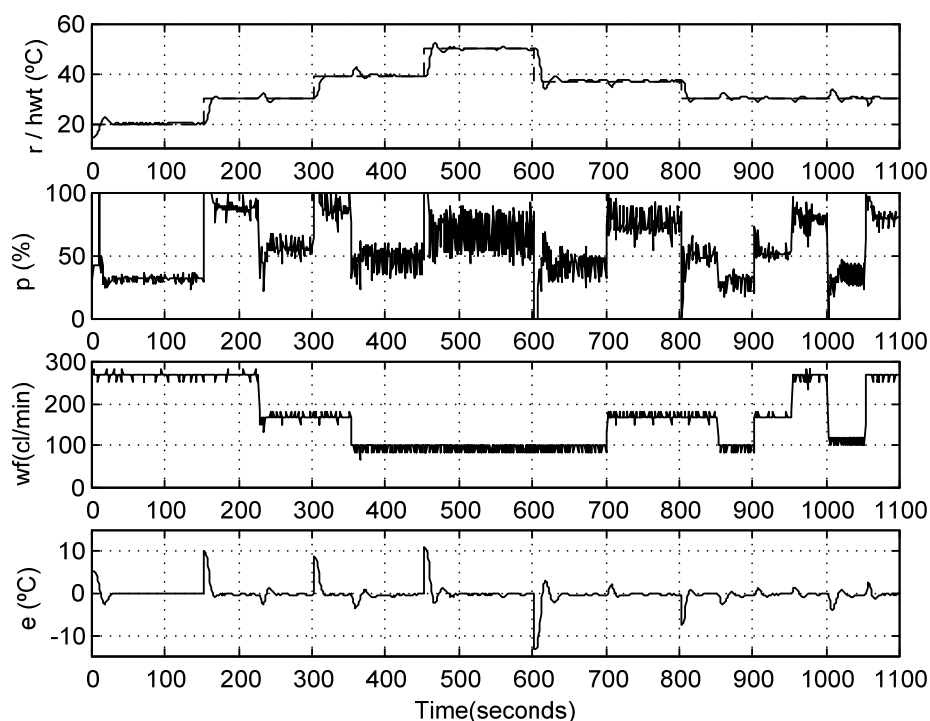

Fig. 9. SPC control results.

It can be seen that for small water flows the resolution of the measure is small that makes the control signal a bit aggressive but it does not affect the output hot water temperature.

For small water flows there is another problem with the multiplicity of the time delay and its resolution. With a sampling period of 1 second it is more difficult to use fractional time delays that happen in reality. This makes the control results a bit aggressive.

The final MSE evaluation control criterion achieved with the SPC is presented in table 2.

Algorithm	MSE Test Set
SPC	3,56

Table 2. Mean square errors of the control results.

The physical model includes à priori knowledge of the real system and has the advantage of been interpretable. This characteristic facilitates the implementation and simplicity the Smith predictive control algorithm.

5. Conclusions

For comparing the two control algorithms, APID and SPC, the reference signals were applied in controlling the system and the respective mean square errors were calculated as showed in table 1 and 2.

This work present and validate the physical model of the electric water heater. This model was based in the model of a gas water heater because of the similarities of both processes.

The MSE of the validation test is very small which validate the physical electric water heater model accuracy.

Finally, the proposed APID and SPC controllers were successful applied in the electric water heater system. It is verify that the SPC achieved much better results than the adaptive proportional integral derivative controller did as it was expected because of the system characteristics.

The best control structure for varying first order systems with varying large time delay is the Smith predictive controller based in physical model of the system as presented in this work. The SPC controller proposed in opposition to the APID controller reacts also very well in cold water temperature variations.

This controller is mathematically simple and easily implemented in a microcontroller with reduce resources.

For future work some improvements should be made as the enlargement of the resolution of the used water flow and the redefinition of the time delay function.

6. References

- Tompson M. L. and Kramer M. A., (1994). Modelling chemical processes using prior knowledge and neural networks, *A. I. Ch. E. Journal*, 1994, vol. 40(8), pp. 1328-1340.
- Pottman M., Pearson R. K., (1998). Block-Oriented NARMAX Models with Output Multiplicities, *AICHE Journal*, 1998, vol. 44(1), pp. 131-140.
- Eskinat E., Johnson S. H. and Luyben W., (1991). Use of Hammerstein Models in Identification of Non-Linear Systems, *AICHE Journal*, 1991, vol. 37(2), pp. 255-268.

- Psichogios D. C. and Ungar L. H., (1992). A hybrid neural network-first principles approach to process modelling, *AIChE Journal*, 1992, vol. 38(10), pp. 1499-1511.
- Cubillos F. A., Alvarez P. I., Pinto J. C., Lima E. L., (1996). Hybrid-neural modelling for particulate solid drying processes. *Power Thecnology*, 1996, vol. 87, pp. 153-160.
- Abonyi J., Madar J. and Szeifert F., (2002). Combining First Principles Models and Neural Networks for Generic Model Control, *Soft Computing in Industrial Applications - Recent Advances*, Eds. R. Roy, M. Koppen, S. O., T. F., F. Homann Springer Engineering Series, 2002, pp.111-122.
- Vieira J., Mota A. (2003). Smith Predictor Based Neural-Fuzzy Controller Applied in a Water Gas Heater that Presents a Large Time-Delay and Load Disturbances, *Proceedings IEEE International Conference on Control Applications*, Istanbul, Turkey, 23 a 25 June 2003, vol. 1, pp. 362-367.
- Vieira J., Mota A. (2004). Parameter Estimation of Non-Linear Systems With Hammerstein Models Using Neuro-Fuzzy and Polynomial Approximation Approaches, *Proceedings of IEEE-FUZZ International Conference on Fuzzy Systems*, Budapest, Hungary, 25 a 29 July 2004, vol. 2, pp. 849-854.
- Vieira J., Dias F. and Mota A. (2005). Hybrid Neuro-Fuzzy Network-Priori Knowledge Model in Temperature Control of a Gas Water Heater System, *Proceedings of 5th International Conference on Hybrid, Intelligent Systems*, Rio de Janeiro, 2005.
- Vieira J. and Mota A. (2004a). Water Gas Heater Non-Linear Physical Model: Optimization with Genetic Algorithms. *Proceedings of IASTED 23rd International Conference on Modelling, Identification and Control*, February 23-25, vol. 1, pp. 122-127.
- Psichogios D. C. and Ungar L. H. (1992) A hybrid neural network-first principles approach to process modelling, *Journal AIChE*, vol. 38(10), pp. 1499-1511.
- Tan Y. and Nazmul Karim M. (2002) Smith Predictor Based Neural Controller with Time Delay Estimation. *Proceedings of 15th Triennial World Congress*, IFAC.
- Tan Y. and Van Cauwenberghe A. R. (1999) Neural-network-Based d-step-ahead Predictors for Nonlinear Systems with Time Delay. *Engineering Applications of Artificial Intelligence*. Vol. 12(1), pp. 21-35.
- Hao Chen, Zouaoui, Z. and Zheng Chen (2011) A neuro-fuzzy compensator based Smith predictive control for FOPLDT process. *Proceedings of International Conference on Mechatronics and Automation (ICMA)*, 2011, pp. 1833 - 1838.
- Dong-Na Shi, Guo Peng and Teng-Fei Li (2008) Gray predictive adaptive Smith-PID control and its application. *Proceedings of International Conference on Machine Learning and Cybernetics*, 2008, vol. 4, pp. 1980 - 1984.
- M. Sbarciog, R. De Keyser, S. Cristea and C. De Prada (2008) Nonlinear predictive control of processes with variable time delay, A temperature control case study. *Proceedings of IEEE Multi-conference on Systems and Control Applications*, San Antonio, Texas, USA, September, 2008, pp. 3-5.



Frontiers of Model Predictive Control

Edited by Prof. Tao Zheng

ISBN 978-953-51-0119-2

Hard cover, 156 pages

Publisher InTech

Published online 24, February, 2012

Published in print edition February, 2012

Model Predictive Control (MPC) usually refers to a class of control algorithms in which a dynamic process model is used to predict and optimize process performance, but it is can also be seen as a term denoting a natural control strategy that matches the human thought form most closely. Half a century after its birth, it has been widely accepted in many engineering fields and has brought much benefit to us. The purpose of the book is to show the recent advancements of MPC to the readers, both in theory and in engineering. The idea was to offer guidance to researchers and engineers who are interested in the frontiers of MPC. The examples provided in the first part of this exciting collection will help you comprehend some typical boundaries in theoretical research of MPC. In the second part of the book, some excellent applications of MPC in modern engineering field are presented. With the rapid development of modeling and computational technology, we believe that MPC will remain as energetic in the future.

How to reference

In order to correctly reference this scholarly work, feel free to copy and paste the following:

José António Barros Vieira and Alexandre Manuel Mota (2012). Adaptable PID Versus Smith Predictive Control Applied to an Electric Water Heater System, *Frontiers of Model Predictive Control*, Prof. Tao Zheng (Ed.), ISBN: 978-953-51-0119-2, InTech, Available from: <http://www.intechopen.com/books/frontiers-of-model-predictive-control/adaptable-pid-versus-smith-predictive-control-apliyed-to-an-electric-water-heater-system->

INTECH
open science | open minds

InTech Europe

University Campus STeP Ri
Slavka Krautzeka 83/A
51000 Rijeka, Croatia
Phone: +385 (51) 770 447
Fax: +385 (51) 686 166
www.intechopen.com

InTech China

Unit 405, Office Block, Hotel Equatorial Shanghai
No.65, Yan An Road (West), Shanghai, 200040, China
中国上海市延安西路65号上海国际贵都大饭店办公楼405单元
Phone: +86-21-62489820
Fax: +86-21-62489821

© 2012 The Author(s). Licensee IntechOpen. This is an open access article distributed under the terms of the [Creative Commons Attribution 3.0 License](#), which permits unrestricted use, distribution, and reproduction in any medium, provided the original work is properly cited.

IntechOpen

IntechOpen