

We are IntechOpen, the world's leading publisher of Open Access books Built by scientists, for scientists

4,800

Open access books available

122,000

International authors and editors

135M

Downloads

Our authors are among the

154

Countries delivered to

TOP 1%

most cited scientists

12.2%

Contributors from top 500 universities



WEB OF SCIENCE™

Selection of our books indexed in the Book Citation Index
in Web of Science™ Core Collection (BKCI)

Interested in publishing with us?
Contact book.department@intechopen.com

Numbers displayed above are based on latest data collected.
For more information visit www.intechopen.com



Electro-Luminescence Based Pressure-Sensitive Paint System and Its Application to Flow Field Measurement

Yoshimi Iijima and Hirotaka Sakaue
*Japan Aerospace Exploration Agency,
Japan*

1. Introduction

Pressure-sensitive paint (PSP) relates a static or oxygen pressure in a testing fluid to a luminescent signal. It uses a photophysical process of oxygen quenching [Lakowicz]. A PSP measurement system requires an illumination source to excite the PSP that can be a xenon lamp, an LED array, and a laser. These are a point illumination that creates a distribution of the illumination on a PSP coated surface. This distribution results in a pressure-independent luminescence from the PSP surface. By rationing with a reference image, the pressure-independent luminescence is cancelled [Liu and Sullivan]. The reference image is obtained under a constant pressure. It is only related to the pressure-independent luminescence mainly due to the distribution of the illumination and a movement and/or distortion in a testing article. The rationing method is valid when there is no movement and/or distortion in the article. If there is such a case, a misalignment of the images may occur that causes a substantial error to a PSP measurement. In addition to the illumination problem, a PSP in general has a temperature dependency [Liu and Sullivan]. This also creates an error to a PSP measurement. For example, a platinum-porphyrin based PSP changes about 1% of the luminescent signal by 1 °C change in temperature. This is equivalent to the 1 kPa change in the luminescence signal.

Electro-luminescence (EL) gives a surface illumination instead of a point illumination. This may reduce the misalignment error. An inorganic EL has a potential to spray on a testing article. This will open our application to provide a testing article with an illumination layer mounted. Previous studies reported that an EL has a temperature dependency [Airaghi *et al*, Schulze *et al*]. The illumination output of the EL increased with an increase of the temperature. The temperature dependency is opposite to that of a conventional PSP. The combined system of the PSP and EL may reduce the overall temperature dependency of the PSP system.

In this chapter, we introduce an EL-based PSP system. A spectral characterization as well as a spatial uniformity of an EL is described. The temperature and pressure calibrations of the system are included. The resultant system is demonstrated to obtain a pressure distribution created by an impinging jet.

2. Background

2.1 Inorganic electro-luminescence

An electro-luminescence (EL) uses a luminescent particle, which is electrically excited to give an illumination output [Destriau]. An EL can be categorized as an inorganic and organic EL based on a material of the particle and an illumination mechanism. An inorganic EL, which is commercially available, uses a phosphor as a luminescent particle. It can be a powder or a thin-film. A powder-type EL can be applicable to spray on a testing article. Fig. 1 shows a schematic of a powder-type inorganic EL. It consists of multi-layers in addition to a phosphor layer.

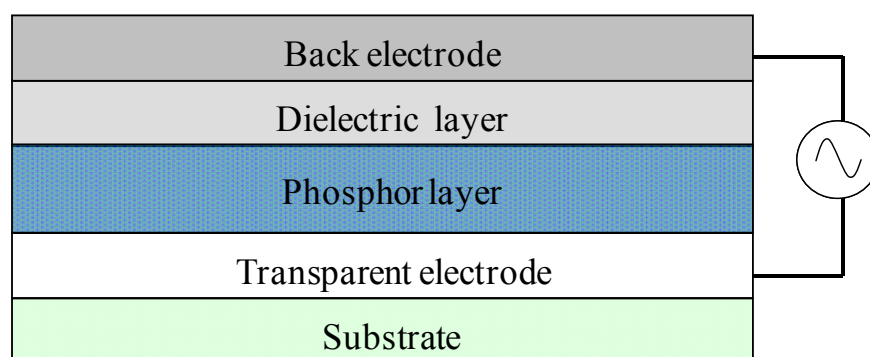

Fig. 1. Multi-layer construction of an electro-luminescence (EL)

2.2 Pressure-Sensitive Paint (PSP)

Based on the oxygen quenching, the luminescent signal, I , can be related to a static pressure by using the Stern-Volmer equation [Liu and Sullivan].

$$\frac{I_{ref}}{I} = A_p + B_p P \quad (1)$$

Where A_p and B_p are calibration coefficients. As a pressure calibration, B_p denotes the pressure sensitivity, σ . A high σ gives more sensitive to the pressure.

$$\sigma = \left. \frac{d(I_{ref}/I)}{dp} \right|_{p=p_{ref}} = B_p \text{ (\%/kPa)} \quad (2)$$

A temperature characterization of a PSP can be described as the second order polynomial in Eq. (3):

$$\frac{I}{I_{ref}} = c_{T0} + c_{T1}T + c_{T2}T^2 \quad (3)$$

Here, c_{T0} , c_{T1} , and c_{T2} are calibration constants at atmospheric conditions. The luminescent signal is denoted as I , and T denotes the temperature. The subscript *ref* denotes the reference conditions. The reference conditions were at 100 kPa and 23 °C. Throughout the

temperature and pressure calibrations as well as the application to the flow measurement, we used these reference conditions. We defined the temperature dependency, δ , which is a slope of the temperature calibration at the reference conditions.

$$\delta = \left. \frac{d(I/I_{ref})}{dT} \right|_{T=T_{ref}} = c_{T1} + 2c_{T2}T_{ref} \quad (\%/^{\circ}\text{C}) \quad (4)$$

If the absolute value of δ is large, it tells us that the change in I over a given temperature change is also large. This is unfavorable condition as a pressure sensor of a PSP. On the contrary, zero δ means the PSP is temperature independent, which is a favorable condition.

3. Development of Electro-Luminescence based Pressure-Sensitive Paint system

3.1 Characterization setup

Fig. 2 shows the characterization setup for an EL, PSP, and EL-PSP system. We can control the temperature and pressure inside a test chamber. An EL, PSP, and EL-PSP was placed in the chamber under controlled temperature and pressure. The EL was excited by a sinusoidal voltage (Yokogawa, FG300) that creates an AC input. The input was amplified (NF Electronic Instrument, High Speed Power Amplifier 4055) to give the EL illumination. We set the illumination frequency at 1 kHz throughout this chapter. A spectrometer (Hamamatsu Photonics, Photonic Multichannel Analyzer) was used to obtain the luminescent output related to the wavelength. When obtaining the PSP output, we placed a high-pass filter of 600 nm in front of the spectrometer to exclude the illumination. The characterization setup also used a 16-bit CCD camera (Hamamatsu Photonics) to acquire the PSP intensity. Depending on the pressure dye used for a PSP, we placed a band-pass filter in front of the camera to acquire the PSP image (section 3.3). As a comparison, a xenon lamp with a band-pass filter of 400 ± 50 nm was used as a conventional illumination source.

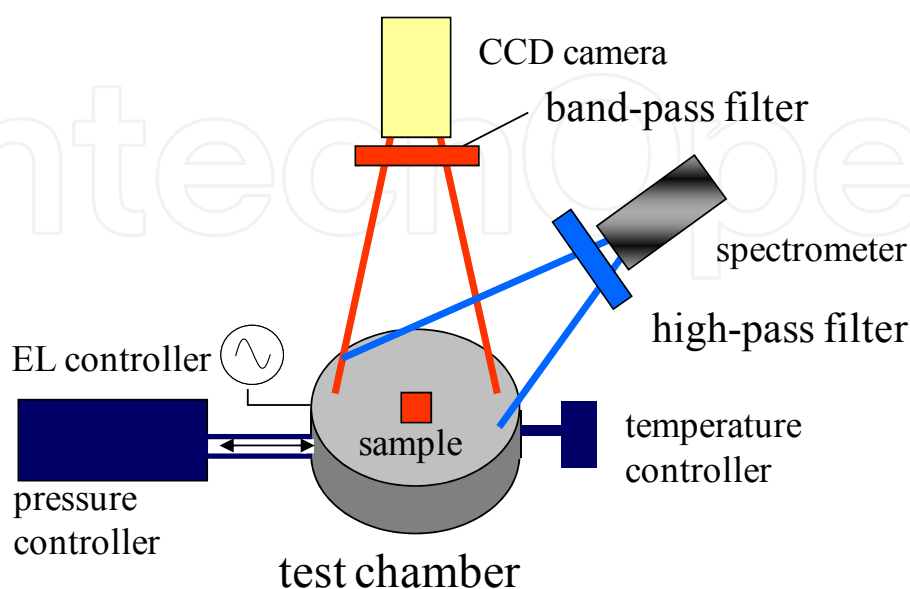

Fig. 2. Schematic of the characterization setup

3.2 EL characterization

Fig. 3 shows the temperature spectra of the inorganic EL used (Nippon Membrane). A peak exists at 500 nm with a broad spectrum from 400 to 650 nm. The output was normalized at the peak illumination at the reference temperature. As we can see, the illumination output increases with an increase of the temperature.

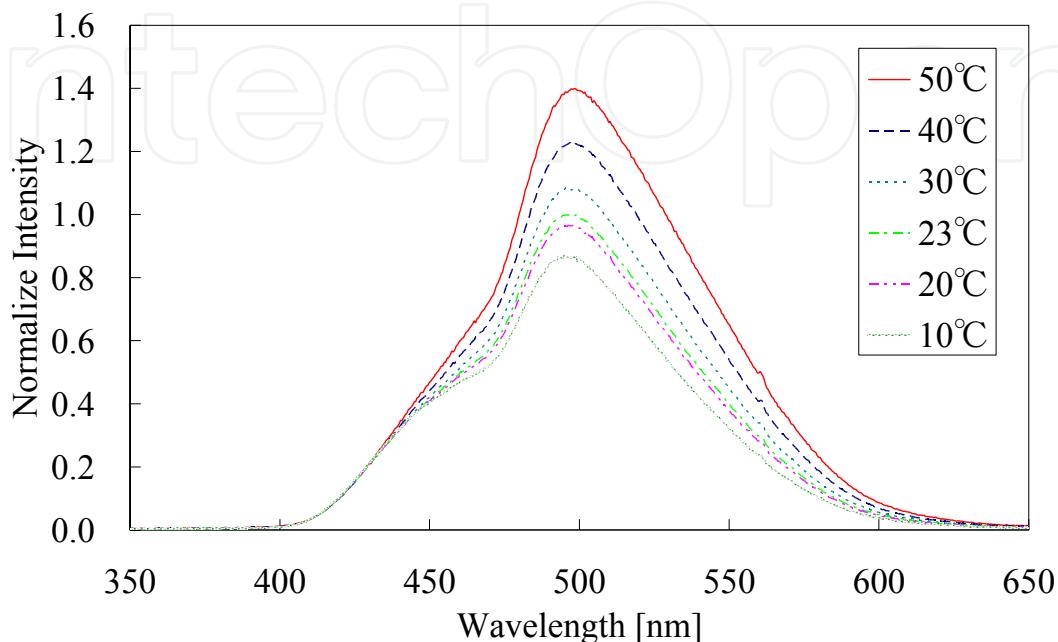

Fig. 3. The temperature spectra of the inorganic EL used

We integrated the spectrum from 400 to 600 nm to determine the illumination intensity. Fig. 4 (a) and (b) show a temperature and pressure calibration. The temperature calibration was obtained under atmospheric conditions. For the temperature calibration, Eq. (3) was fitted to the calibration data. For the pressure calibration, Eq. (1) was fitted to the calibration data. The values of δ and σ were 1.1 %/°C and 0 %/kPa, derived from Eqs. (4) and (2), respectively. As seen in the illumination spectra (Fig. 3), the intensity increased with an increase of the temperature. As described in section 3.3, the temperature dependency of the EL was opposite to that of the PSP; the EL increases its intensity with temperature but the PSP decreases its intensity. On the other hand, the intensity was independent of the pressure.

Fig. 5 (a) shows the illumination uniformity of the EL. As a comparison, an illumination image was obtained from the xenon lamp (Fig. 5 (b)). The images were acquired by the CCD camera with the fixed distance from the illuminated surface. The same area of 30-mm in square was shown. This includes non-illuminated area, which is shown as dark area in Fig. 5. The EL has the size of 25-mm square. For the xenon lamp, it illuminated the EL surface, while the EL was switched off. An illumination tip of a xenon lamp was adjusted to place at the edge of the EL square. The dark area was used as the minimum illumination to normalize the illumination output. The mean output at the center of the illuminated area was used as the maximum illumination for the normalization. Here, d denotes the length of the image area to extract the trend in the illumination in the horizontal axis. Because a xenon

lamp is a point illumination source, it showed a non-uniform illumination over the square. On the other hand, the EL showed a uniform illumination over the square. To compare the illumination uniformity, cross sectional distributions given in lines 1 through 4 were shown below each illumination image. The difference from the area averaged value of illumination was shown. As we can see, the EL showed fairly identical in the distributions, while the xenon source showed variations in the illumination.

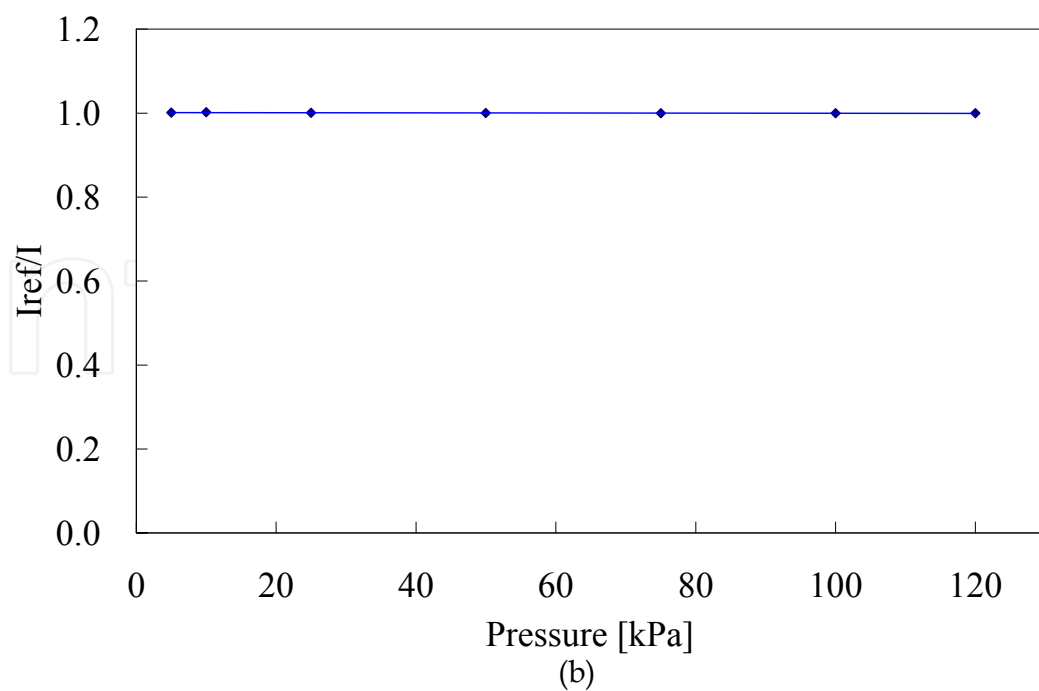
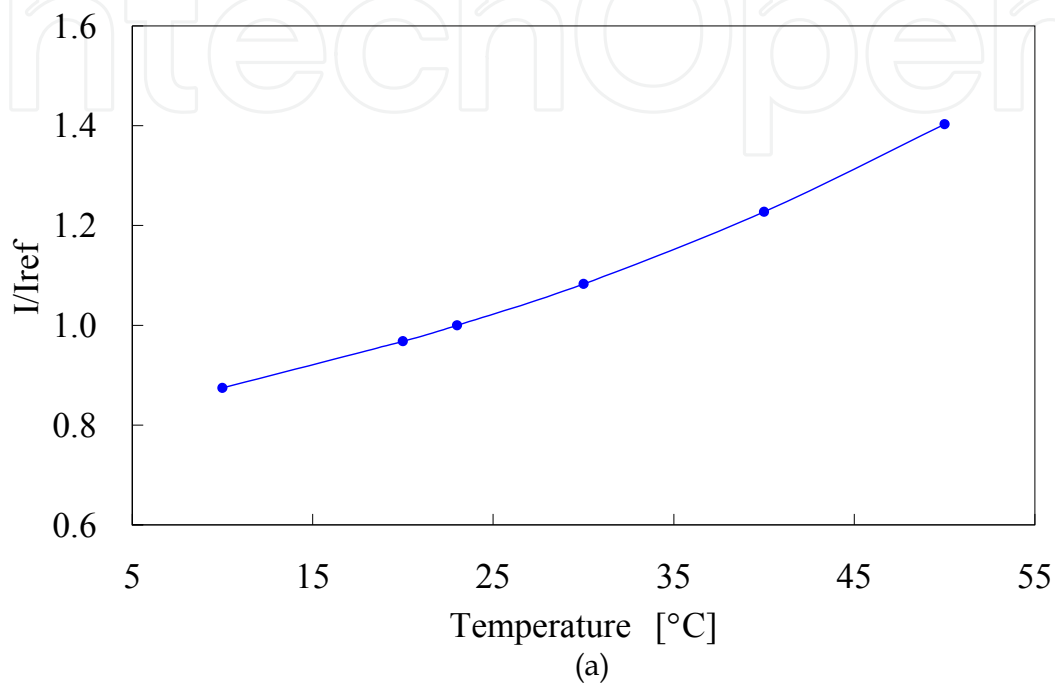

Fig. 4. (a). The temperature calibration of the EL used; (b). The pressure calibration of the EL used

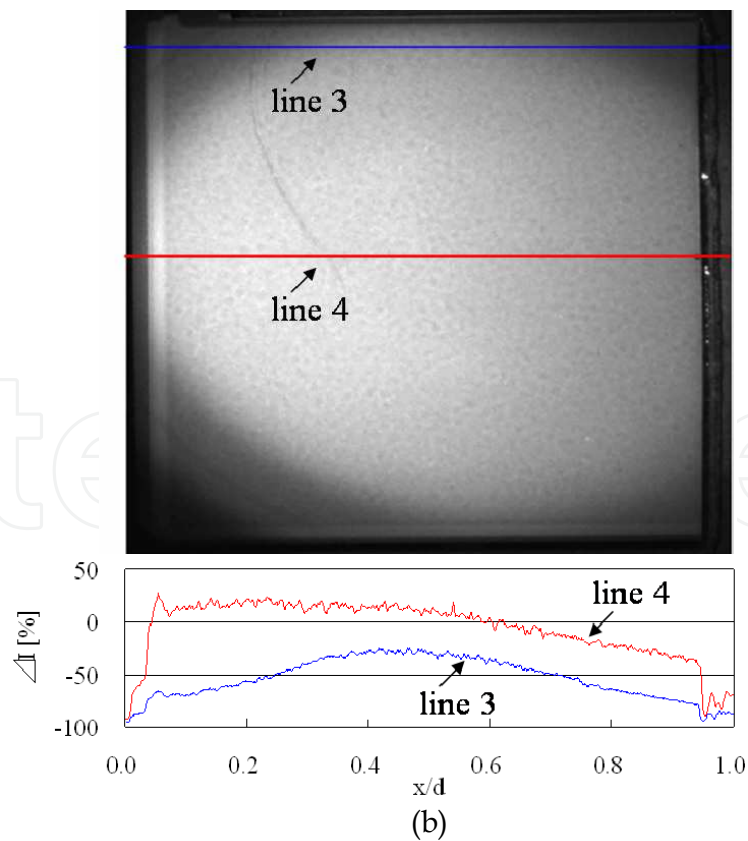
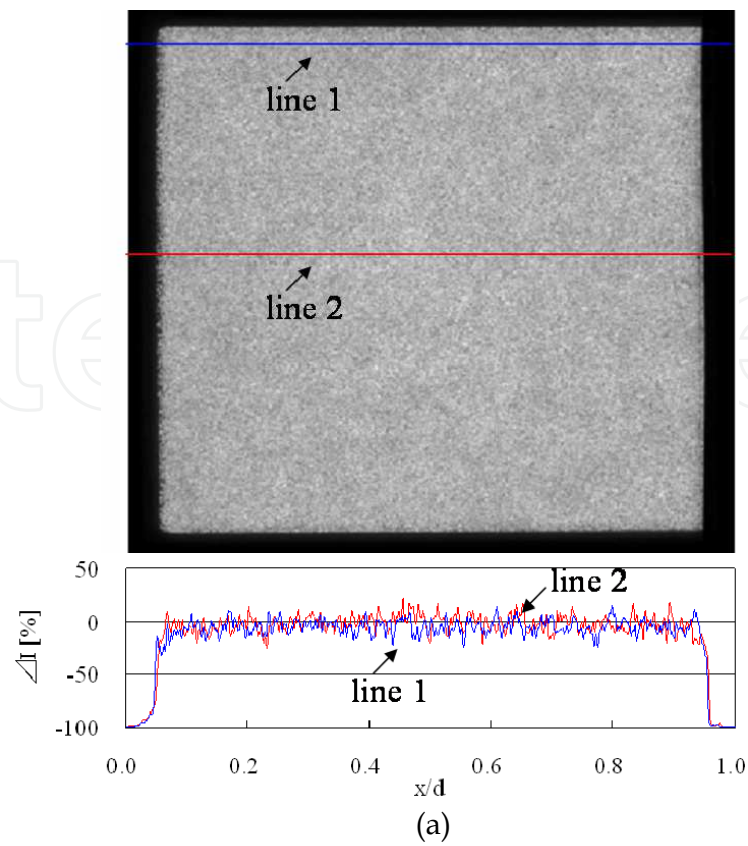

Fig. 5. (a). Illumination uniformity of the EL; (b). Illumination uniformity of a xenon lamp. ΔI denotes the difference in the illumination outputs

3.3 EL-PSP characterization

To tailor the EL as an illumination source for a PSP system, we need to exclude the overlaid spectra between the EL and a PSP emission. We used platinum porphyrin (PtTFPP) and bathophen ruthenium (Ru(dpp)) as a pressure dye in a PSP component, which is commonly used for a conventional PSP system. We inserted a band-pass filter (Fujifilm, BPB50) to exclude the spectral overlay. It is a sheet filter made of a tri acetyl cellulose with its thickness of 90 μm . Fig. 6 shows the transmittance of the band-pass filter. This filter cuts off from 580 to 680 nm, which corresponds to the emission of the PSPs for the EL-PSP system.

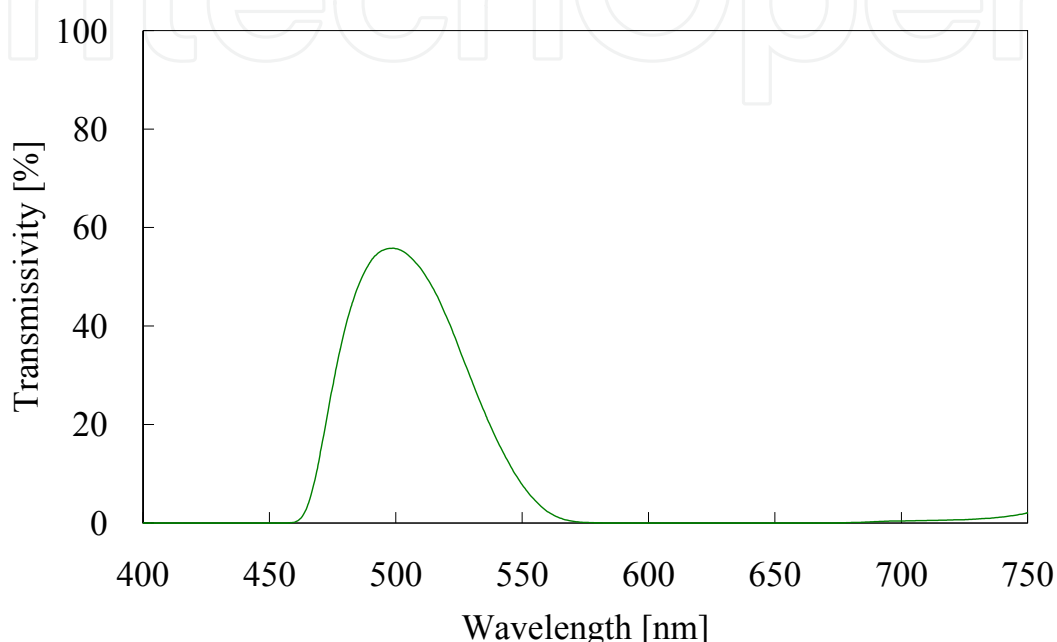

Fig. 6. Transmittance (%) of a sheet band-pass filter to prevent a spectral overlay between the EL illumination of PSP emission.

The developed EL-PSP system consists of the EL, the band-pass filter, and a PtTFPP based PSP. This PSP uses poly-IBM-co-TFEM as a polymer. Similar to PtTFPP, Ru(dpp) based EL-PSP system consist of the EL, the same band-pass filter, and a Ru(dpp) based PSP. This PSP uses RTV118 as a polymer. Overall thickness of the EL-PSP layer was 0.9 mm. In the present case, an EL-PSP layer was provided. It can be applied on a simple curvature, such as a cylinder. If a spraying process would be developed for an inorganic EL, it would be possible to spray the EL-PSP on a complex geometry. Fig. 7 showed the spectral outputs of PtTFPP based EL-PSP system and Ru(dpp) based EL-PSP system, respectively. The former emitted at 650 nm peak, while the latter emitted a broad region with a peak at 600 nm. Note that, due to the sheet filter, the EL illumination did not exist over 580 nm. Because the PSP emission was on top of this filter, the emission was not influenced. Therefore, the PSP emission of Ru(dpp) showed its emission below 580 nm.

Fig. 8 shows the temperature calibrations of the EL-PSP systems. We used a band-pass filter of 650 ± 20 nm in front of the CCD camera to determine the luminescent intensity for PtTFPP based EL-PSP systems, while a band-pass filter of 600 – 750 nm for Ru(dpp) based EL-PSP system. As a comparison, the results of a conventional PSP system were shown. Here, a conventional PSP system uses the same luminophore and polymer as the EL-PSP

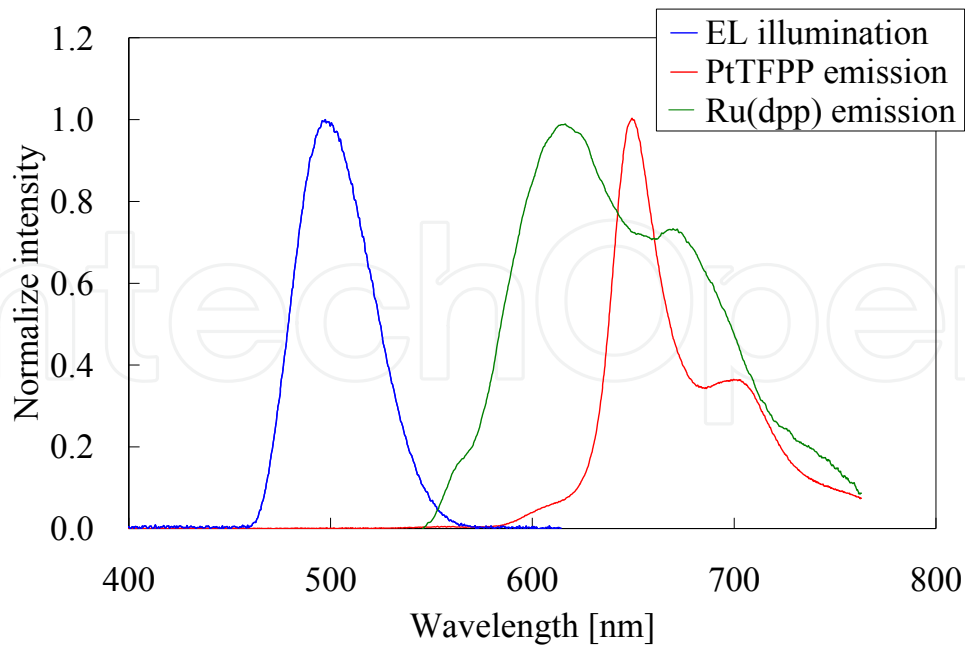

Fig. 7. Luminescent spectra of PtTFPP based EL-PSP system and Ru(dpp) based EL-PSP system

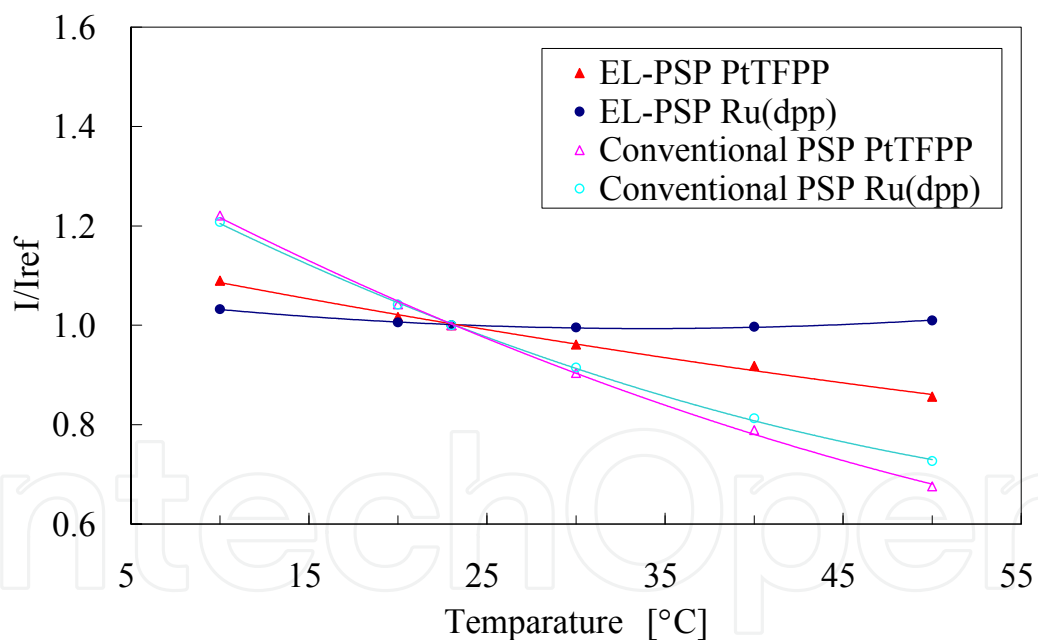

Fig. 8. The temperature calibration of the EL-PSP systems compared to that of a conventional PSP system

systems but uses a xenon lamp as an illumination. PtTFPP based EL-PSP system showed δ of $-0.6 \text{ \%}/^\circ\text{C}$, while the corresponding conventional PSP showed $-1.3 \text{ \%}/^\circ\text{C}$, respectively. This EL-PSP system could reduce δ by 54%. On the other hand, Ru(dpp) based EL-PSP system showed δ of $-0.1 \text{ \%}/^\circ\text{C}$, while the corresponding conventional PSP showed $-1.2 \text{ \%}/^\circ\text{C}$, respectively. This EL-PSP system could reduce δ by 92%. The temperature calibrations tell that the combination of an EL and PSP greatly influences the temperature dependency.

Fig. 9 shows the pressure calibrations of the EL-PSP systems. Similar to the temperature calibration, the pressure calibrations of conventional PSPs were shown for comparisons. As we can see from the calibration results, similar trends can be seen for all results. Based on Eq. (2), σ of the EL-PSP systems and conventional PSPs were 0.8 %/kPa.

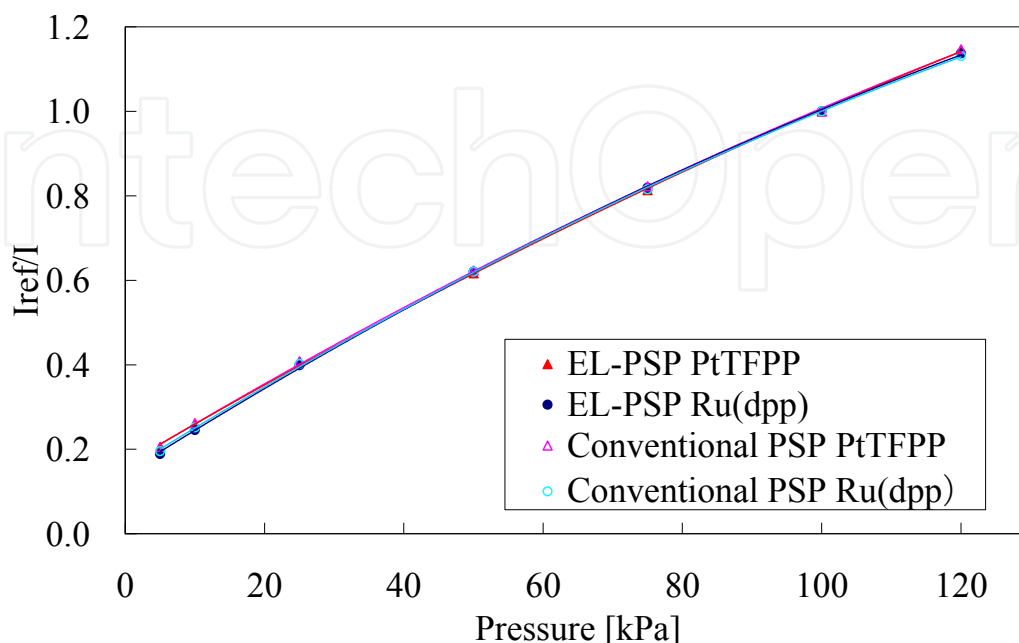

Fig. 9. The pressure calibration of the EL-PSP systems compared to that of a conventional PSP system

4. Demonstration

4.1 Demonstration setup

We applied the developed system to a sonic jet impingement for comparison. A schematic of the experimental setup is shown in Fig. 10. A sonic jet from a 2-mm orifice was impinged on the EL-PSP surface. The same camera and optical filter in calibrations (section 3.1) were used to acquire the luminescent image from the system. The camera was placed above the system as shown in Fig. 10. To discuss a temperature dependency of the measurement, we acquired two reference images: one at the ambient temperature of 23 °C, and the other at a higher temperature of 30 °C. These reference images were acquired when there was no flow that provided the constant pressure at 100 kPa over the EL-PSP surface. As a comparison, a conventional PSP system was used to acquire the same flow. In this system, a xenon lamp through 400 ± 50 nm instead of the EL illumination was used as an excitation. The EL was switched off during this measurement.

4.2 Global pressure measurement and discussion

Fig. 11 (a) and (b) show pressure maps obtained from PtTFPP based and Ru(dpp) based EL-PSP systems. *A priori* pressure calibration obtained in Fig. 9 was used to convert the luminescent image to the pressure map. The ambient reference was used as a reference image. It showed a clear diamond shock pattern created by the sonic jet impingement. We can notice small scratch-like spots in the pressure maps. These were created during the preparation process of the EL-PSP layer, which can be improved to layer the EL, the sheet filter, and PSP.

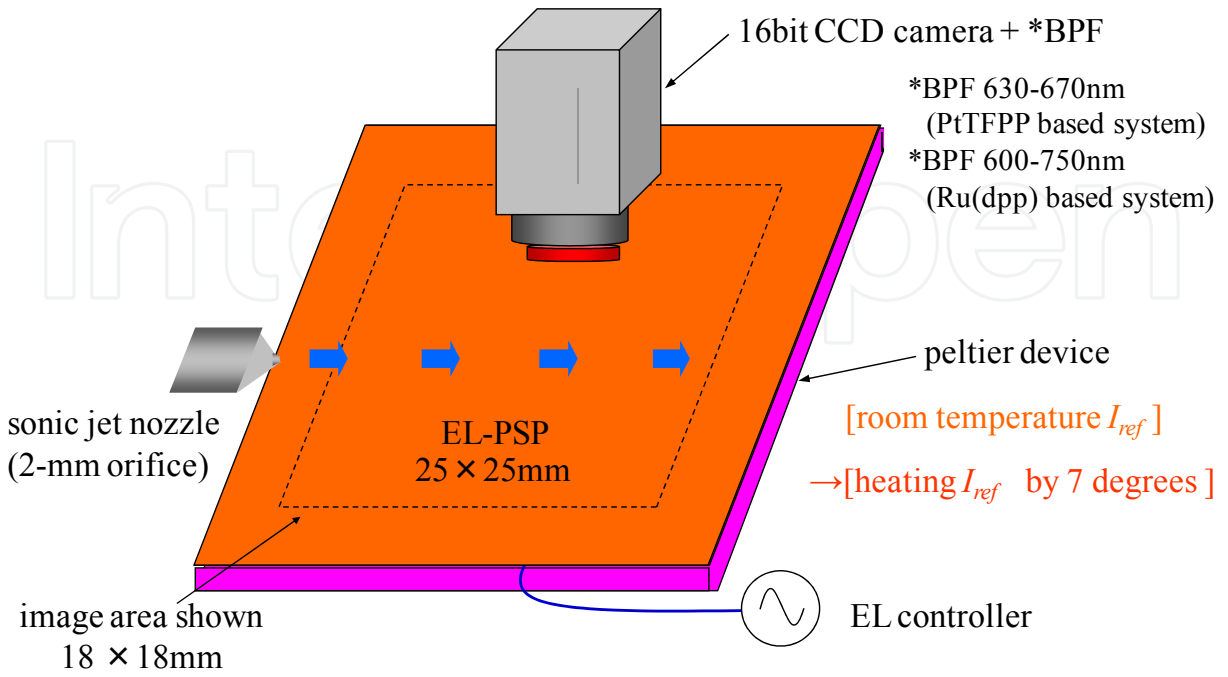
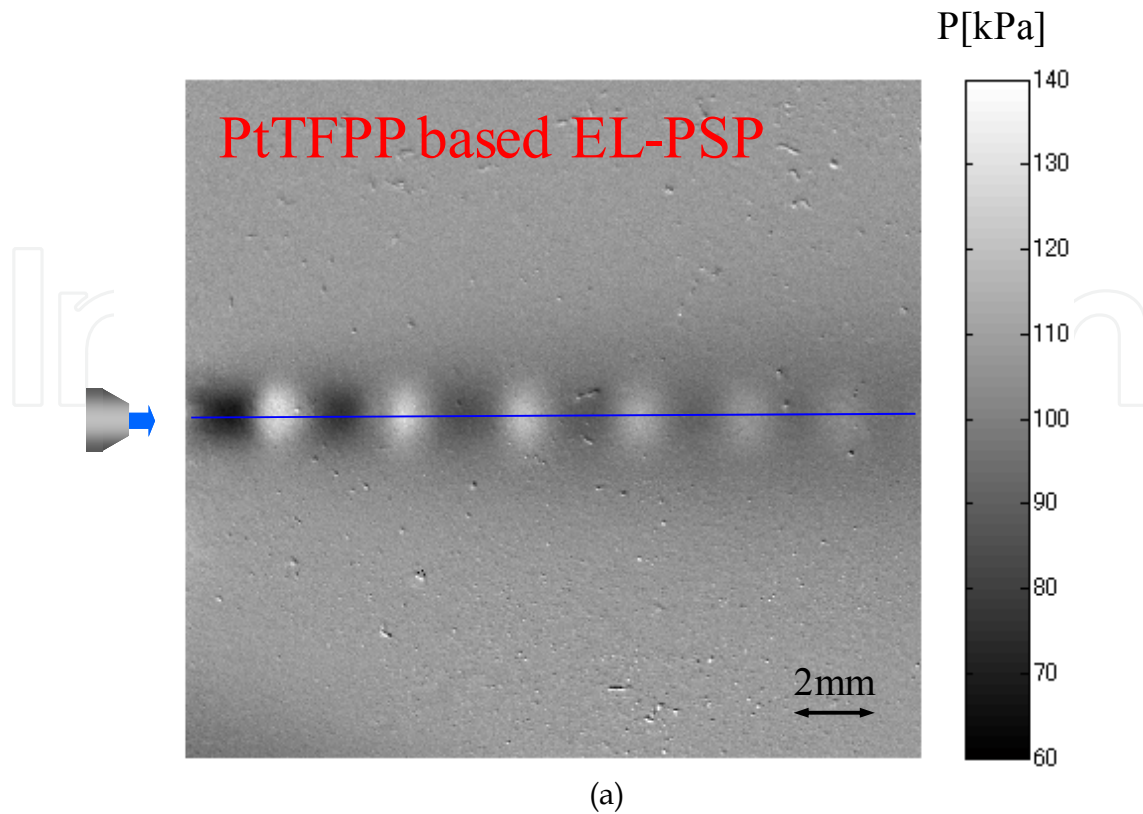

Fig. 10. Schematic description of the demonstration setup



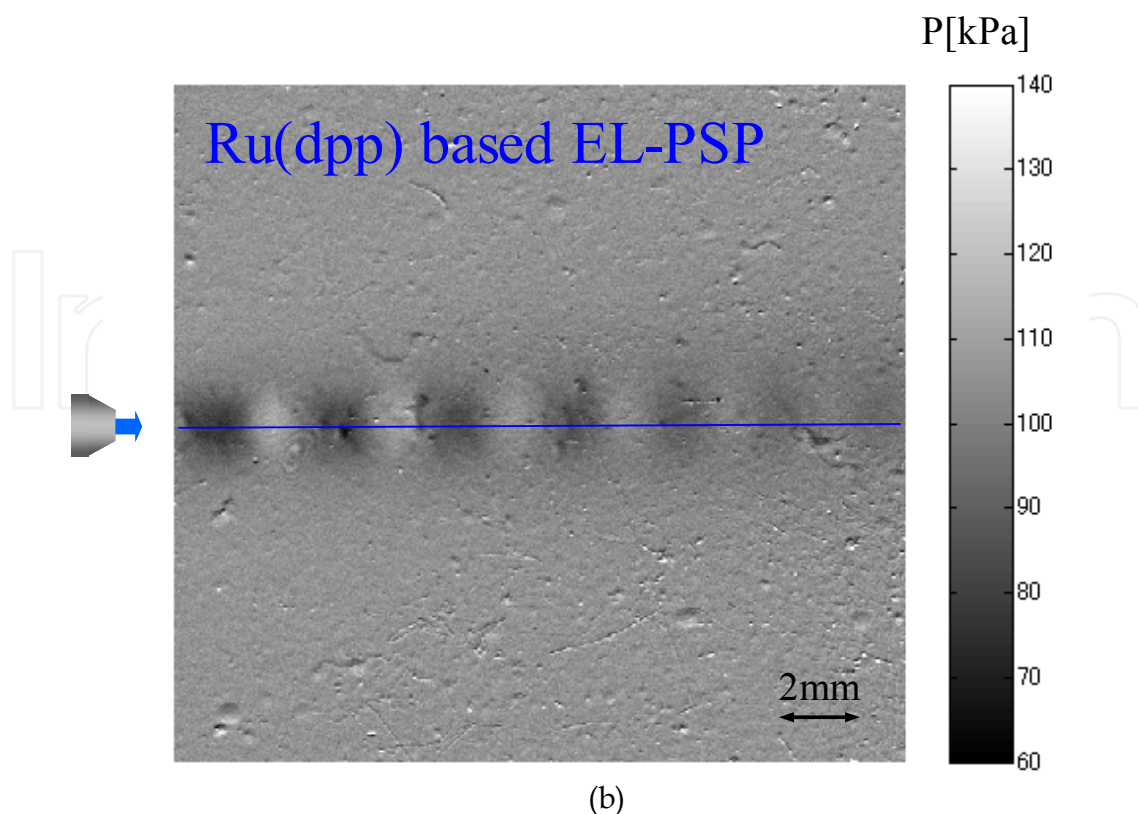
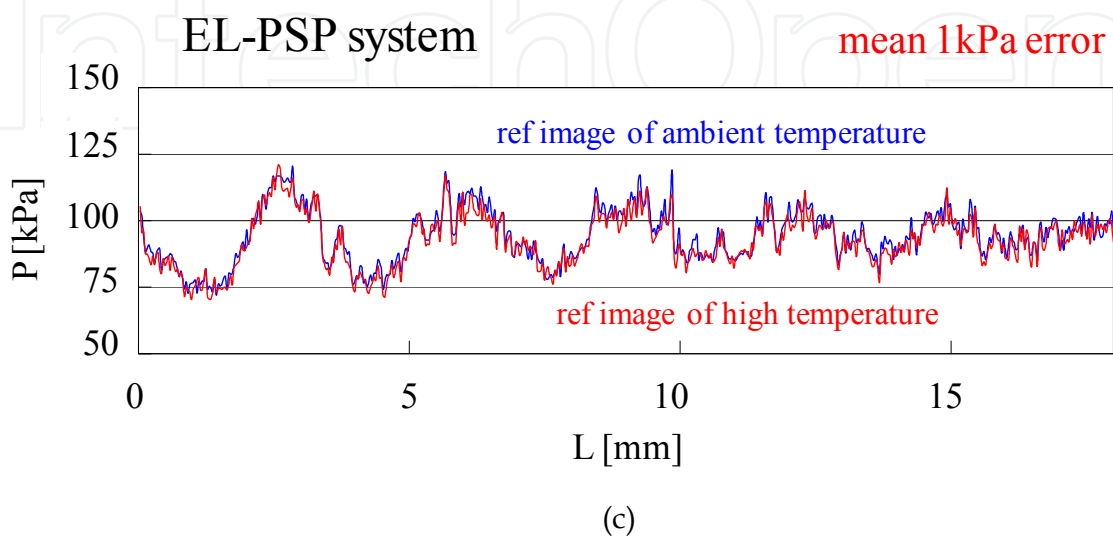
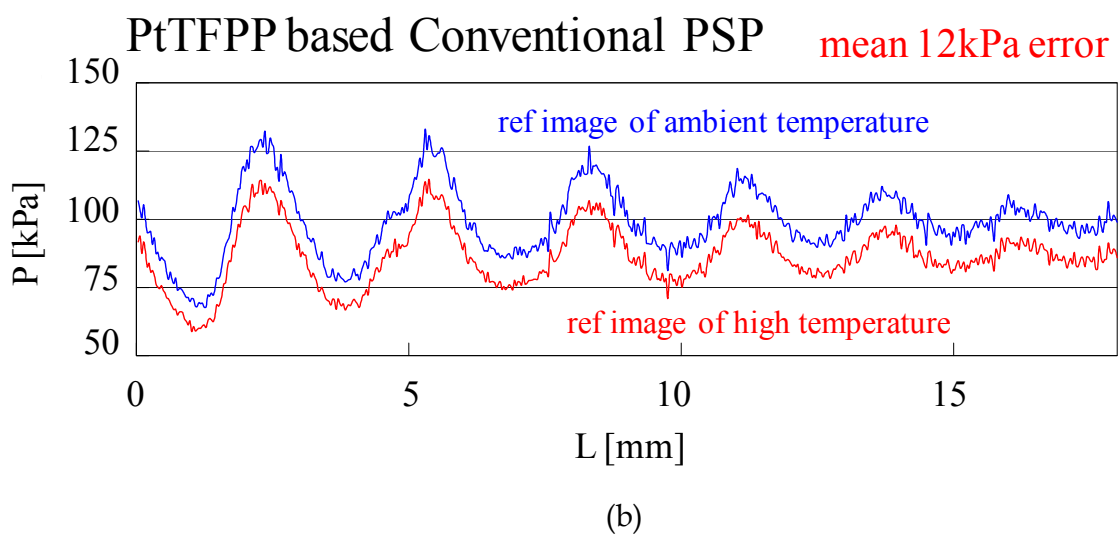
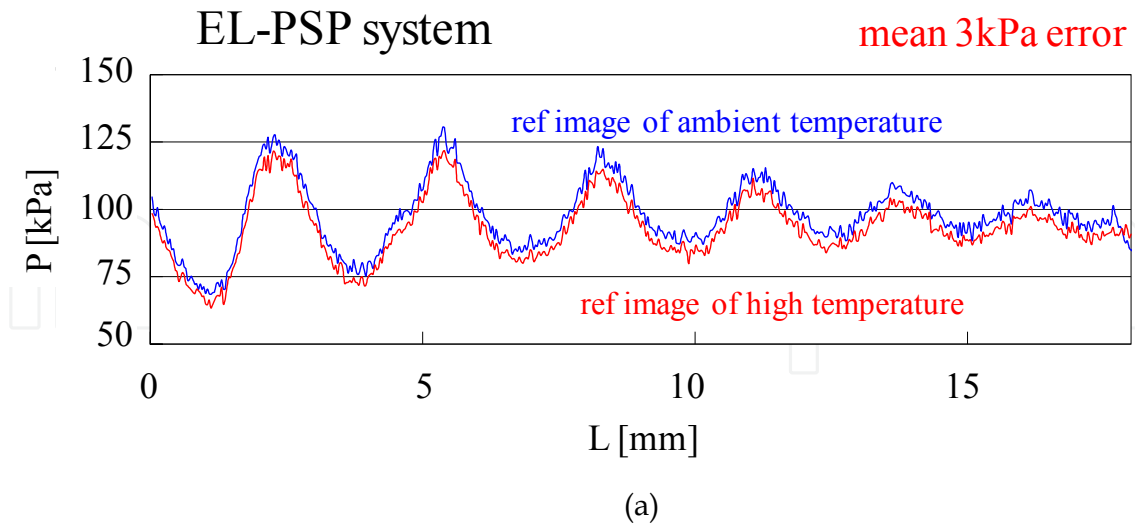

Fig. 11. Pressure maps created by a sonic jet impingement obtained from (a) PtTFPP based EL-PSP system and (b) Ru(dpp) based EL-PSP system

Fig. 12 (a) through (d) show cross-sectional pressure distributions along the centerline of the jet impinging surface. The location of the centerline was shown as a solid line in Fig. 11. Here $L = 0$ denotes the left edge of the solid line in Fig. 11. Fig. 12 (a) showed the distribution from PtTFPP based EL-PSP system, and Fig. 12 (b) showed the results from the conventional PSP system, respectively. Similarly, Fig. 12 (c) and (d) are a comparison between Ru(dpp) based EL-PSP system and Ru(dpp) based conventional PSP. The scratch-like spots discussed in Fig. 11 was obvious for the pressure distributions from Ru(dpp) based EL-PSP system. For each figure, the pressure distributions obtained from the pressure map results under the ambient and the high temperature reference were shown. As increasing the temperature, the luminescent intensity was reduced (Fig. 8). The high temperature reference, therefore, gave lower luminescent ratio in the left hand side of Eq. (1). This results in an underestimated pressure. We can see that both systems showed the underestimation of the pressure distributions. For the EL-PSP system, the pressure distribution showed smaller change in the pressure measurement compared to that of the conventional PSP system. The difference in the pressure measurement was an average of 3 kPa for PtTFPP based EL-PSP system, while the corresponding conventional PSP was an average of 12 kPa. There was a 75% improvement in the temperature dependency for the pressure measurement obtained from PtTFPP based EL-PSP system. Because Ru(dpp) based EL-PSP system showed very small temperature dependency ($-0.1 \text{ \%}/^{\circ}\text{C}$, section 3.3), pressure distributions obtained from the different references were almost identical. The difference in the pressure measurement was an average of 1 kPa. On the other hand, Ru(dpp) based conventional PSP showed the difference of an average of 15 kPa. For Ru(dpp) based EL-PSP system, there was a 93% improvement in the temperature dependency.



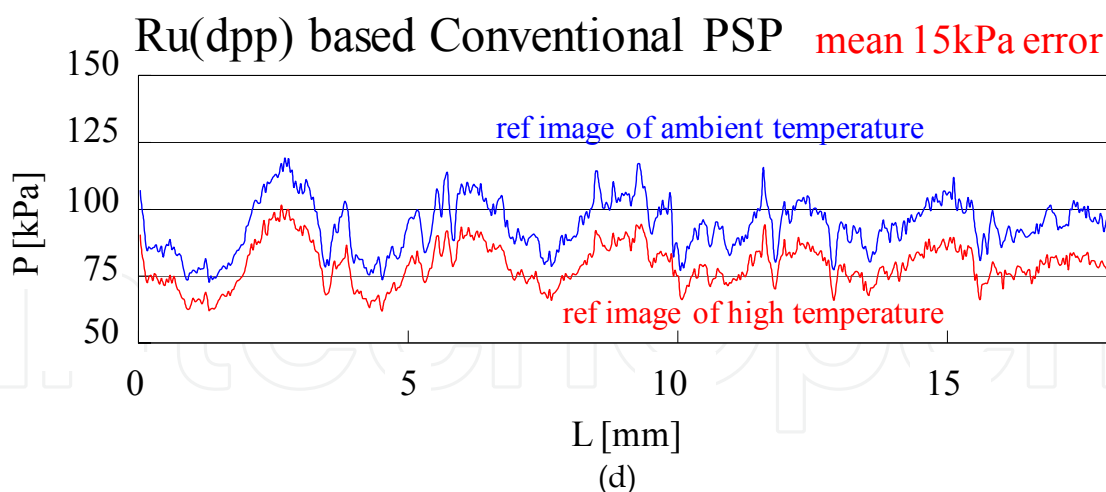

Fig. 12. Cross-sectional pressures obtained from (a) PtTFPP based EL-PSP system, (b) PtTFPP based conventional PSP system, (c) Ru(dpp) based EL-PSP system, and (d) Ru(dpp) based conventional PSP system. Pressures under ambient temperature and a high temperature were shown for each figure

The reference image was shifted about 2 mm towards the downstream to provide a misalignment of the image. This changed the distribution in the pressure independent luminescence between the reference and jet impinged images. The shifted reference was aligned by an image processing as commonly used for a PSP measurement. Fig. 13 (a) and (b) show the pressure maps obtained from PtTFPP based EL-PSP system and conventional PSP system with the image alignment process, respectively. Because the 2-mm width of the upstream area was not acquired it was shown as a shaded area. The EL-PSP system can provide a pressure distribution as seen in Fig. 11 (a). This tells us that a uniform illumination of the EL can reduce the pressure-independent luminescence and extract the pressure distribution. On the other hand, a point illumination of the conventional PSP system showed a distribution which is not caused by the pressure (Fig. 11 (a)). The processed image could not remove the pressure independent luminescence caused by a non-uniform illumination. This was because the distribution in the pressure independent luminescence obtained by the point illumination was different from the reference and jet impinged images. By using the EL as a surface illumination, the EL-PSP system greatly reduced the misalignment error.

5. Conclusion

We introduced a pressure-sensitive paint (PSP) measurement system based on an electro-luminescence (EL) as a surface illumination. This consisted of an inorganic EL as the illumination, a band-pass filter, and a PSP. The band-pass filter, which passed below 580 nm, was used to separate an overlay of the EL illumination and the PSP emission. In this chapter, two types of PSPs were used to construct the EL-PSP system. One is platinum porphyrin (PtTFPP) based PSP, which gave the emission at 650-nm peak. The other is bathophen ruthenium (Ru(dpp) based PSP, which gave a broad emission with a peak at 600 nm. The EL showed an opposite temperature dependency to that of the PSPs; the illumination intensity of the EL increased with increase temperature with the temperature dependency of 1.1 %/°C. The EL gave a uniform illumination compared to that of a point illumination source such as a xenon lamp.

IntechOpen

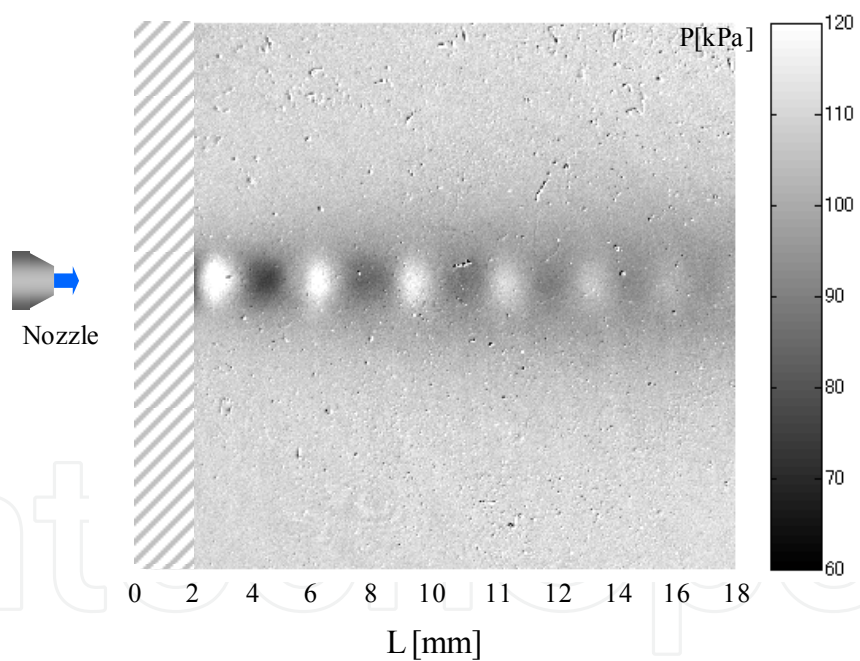
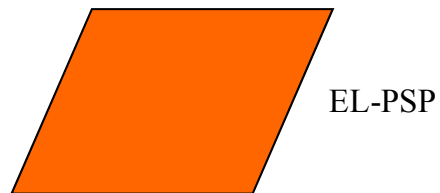
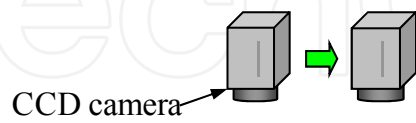

(a)

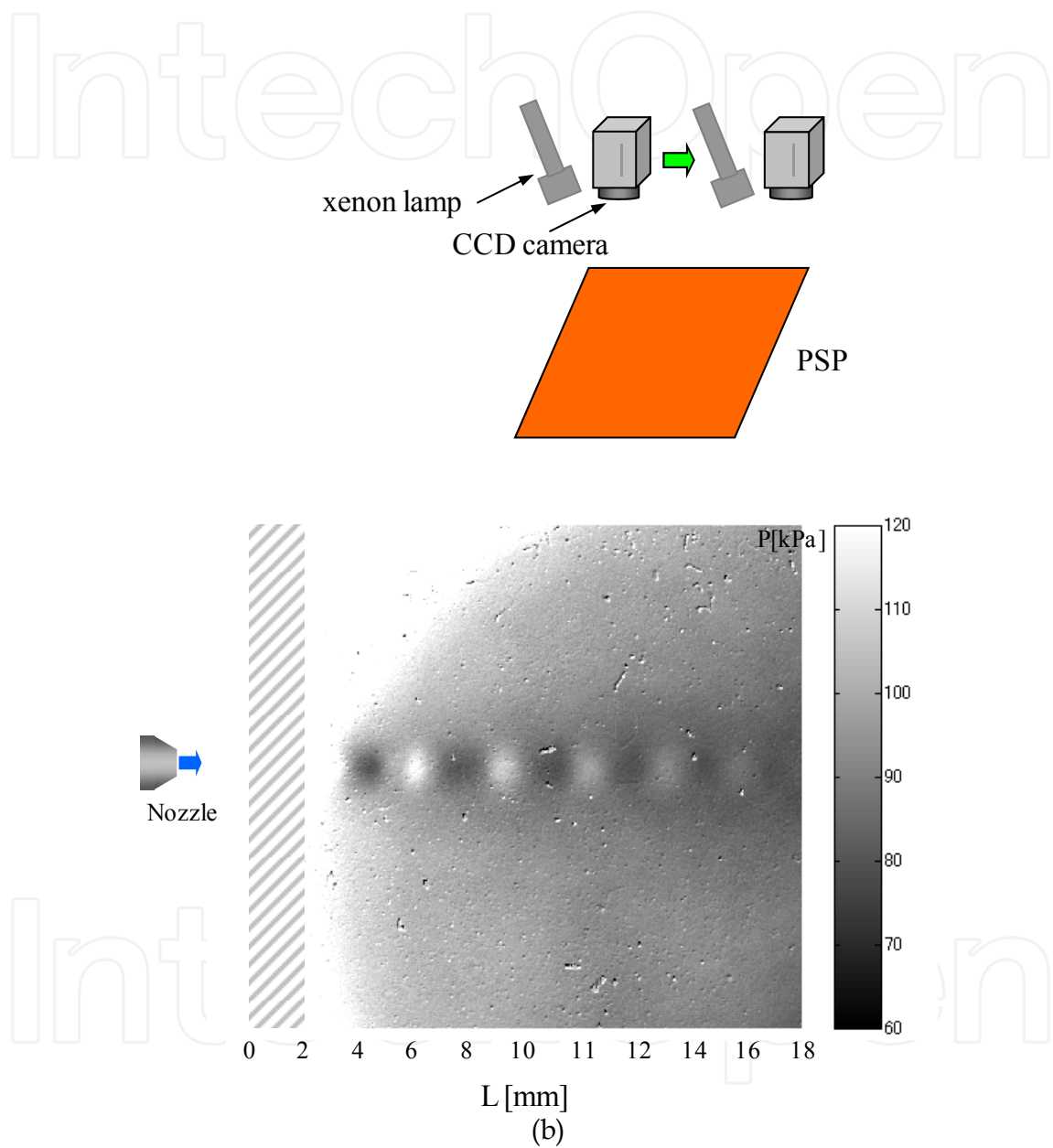

Fig. 13. Pressure maps processed from a misaligned reference image obtained from (a) PtTFPP based EL-PSP system and (b) PtTFPP based conventional PSP system

A combination of EL and PSP greatly influenced the temperature dependency, while a minimal influence could be seen for the pressure sensitivity. Under atmospheric conditions, PtTFPP based EL-PSP system reduced the temperature dependency by 54% compared to that of a conventional PSP system. For Ru(dpp) based EL-PSP system, the temperature dependency was greatly reduced by 92% compared to that of a conventional PSP system. Both EL-PSP systems showed the pressure sensitivity of 0.8 %/kPa, which was the same for conventional PSP systems.

An application of the EL-PSP systems to a sonic jet impingement showed that the systems demonstrated the reduction of the temperature dependency compared to that of the conventional PSP system. The temperature dependency was reduced by 75% in a pressure measurement for PtTFPP based EL-PSP system, while by a reduction of 93% was obtained for Ru(dpp) based EL-PSP system. Because of a uniform illumination, the EL-PSP system could reduce an image misalignment error compared to that of the conventional PSP system.

6. References

- B. Schulze, C. Klein, ICIASF05, Sendai, Japan, August 29-September 1, 274 - 282, (2005)
- G. Destriau, *J. Chem. Phys.*, 33, 587, 1936
- J. R. Lakowicz, *Principles of Fluorescence Spectroscopy*, Kluwer Academic/Plenum Publishers, New York, USA, 1999, Chapter 1
- Liu, T. & Sullivan, J. P. (2004). *Pressure and Temperature Sensitive Paints*, Springer, ISBN 3-540-22241-3, Heidelberg, Germany (Chapter 1 and Chapter 3)
- S. Airaghi, T. Rösger, M. Guille, *Proceedings of 11th International Symposium on Flow Visualization*, University of Notre Dame, Notre Dame, Indiana, USA, paper id number 198, Aug. 9 - 12, (2004)

IntechOpen

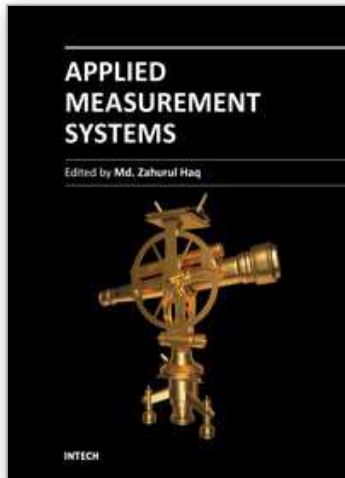

Applied Measurement Systems

Edited by Prof. Zahurul Haq

ISBN 978-953-51-0103-1

Hard cover, 390 pages

Publisher InTech

Published online 24, February, 2012

Published in print edition February, 2012

Measurement is a multidisciplinary experimental science. Measurement systems synergistically blend science, engineering and statistical methods to provide fundamental data for research, design and development, control of processes and operations, and facilitate safe and economic performance of systems. In recent years, measuring techniques have expanded rapidly and gained maturity, through extensive research activities and hardware advancements. With individual chapters authored by eminent professionals in their respective topics, Applied Measurement Systems attempts to provide a comprehensive presentation and in-depth guidance on some of the key applied and advanced topics in measurements for scientists, engineers and educators.

How to reference

In order to correctly reference this scholarly work, feel free to copy and paste the following:

Yoshimi Iijima and Hiroataka Sakaue (2012). Electro-Luminescence Based Pressure-Sensitive Paint System and Its Application to Flow Field Measurement, Applied Measurement Systems, Prof. Zahurul Haq (Ed.), ISBN: 978-953-51-0103-1, InTech, Available from: <http://www.intechopen.com/books/applied-measurement-systems/electro-luminescence-based-pressure-sensitive-paint-system-and-its-application-to-flow-field-measure>

INTECH
open science | open minds

InTech Europe

University Campus STeP Ri
Slavka Krautzeka 83/A
51000 Rijeka, Croatia
Phone: +385 (51) 770 447
Fax: +385 (51) 686 166
www.intechopen.com

InTech China

Unit 405, Office Block, Hotel Equatorial Shanghai
No.65, Yan An Road (West), Shanghai, 200040, China
中国上海市延安西路65号上海国际贵都大饭店办公楼405单元
Phone: +86-21-62489820
Fax: +86-21-62489821

© 2012 The Author(s). Licensee IntechOpen. This is an open access article distributed under the terms of the [Creative Commons Attribution 3.0 License](#), which permits unrestricted use, distribution, and reproduction in any medium, provided the original work is properly cited.

IntechOpen

IntechOpen