

We are IntechOpen, the world's leading publisher of Open Access books Built by scientists, for scientists

4,800

Open access books available

122,000

International authors and editors

135M

Downloads

Our authors are among the

154

Countries delivered to

TOP 1%

most cited scientists

12.2%

Contributors from top 500 universities



WEB OF SCIENCE™

Selection of our books indexed in the Book Citation Index
in Web of Science™ Core Collection (BKCI)

Interested in publishing with us?
Contact book.department@intechopen.com

Numbers displayed above are based on latest data collected.
For more information visit www.intechopen.com



Nanocomposite Materials with Oriented Functionalized Structure

Petrișor Zamora Iordache, Nicoleta Petrea,
Rodica Mihaela Lungu, Răzvan Petre, Ciprian Său and Ioan Safta
*Scientific Research Center for CBRN Defense and Ecology
Romania*

1. Introduction

Functionalized materials are material structures able to meet certain functions and tasks in well established interaction conditions. The functionality of a nanostructured material is completely conditioned by the well-defined relation holding between the functionality of the host structure (carrier support - CS) and the structure upon which it is carried out (target structure - TS). The functionality and the functions of a material are carried out by means of its physical, chemical or other characteristics, and by means of which it interacts with neighbour material systems, in order to fulfil the assigned functions. The most well-known examples of functionalities are those of: chemical reticulation, detection, controlled stimulation, chemical separation, etc. (fig.1). Most of the natural material structures are found in the form of nano or micrometrically structured composites, and dependency and interaction relations are established between their structural elements, depending on the internal structure and the physical and chemical characteristics of the neighbouring material structures. Composite materials are mixtures of material phases, either amorphous, or structurally well delimited, varied from a morphostructural and morphochemical point of view. The basic structure of composite materials is represented by nanostructured material phases, as material superior form of organization of atomic and molecular structures. As a result of physical and chemical interactions, the structural components of natural composites establish complex physical and chemical equilibrium states, characterised by the fact that the functional structure of this type of composites is masked or cancelled.

The functionality concept is a relatively defined concept, taking as a reference point the investigation and order needs of the surrounding material structures. Basically, the function of a functionalized material defines the way in which the functional structure affects a certain process or a certain material structure, not necessarily neighbouring it. All material structures are carriers of certain types of inherent functionalities, by means of which they specifically interact with the exterior, but which do not have selectivity for certain target structures. Most modern scientific and technological applications need nanostructured or nanocomposite materials, having an oriented functional structure. These constraints impose that natural composite materials (CM) should be submitted to morphostructural and morphochemical modelling processes, in order to use them as oriented functionality materials. From the point of view of the sense of functionality orientation, the materials with oriented functional structure (M_{OF}) can be defined as materials whose structure and

characteristics model and transform in sequences that are phenomenologically ordered in space and time, the structural evolution and the properties of the target structures (TS).

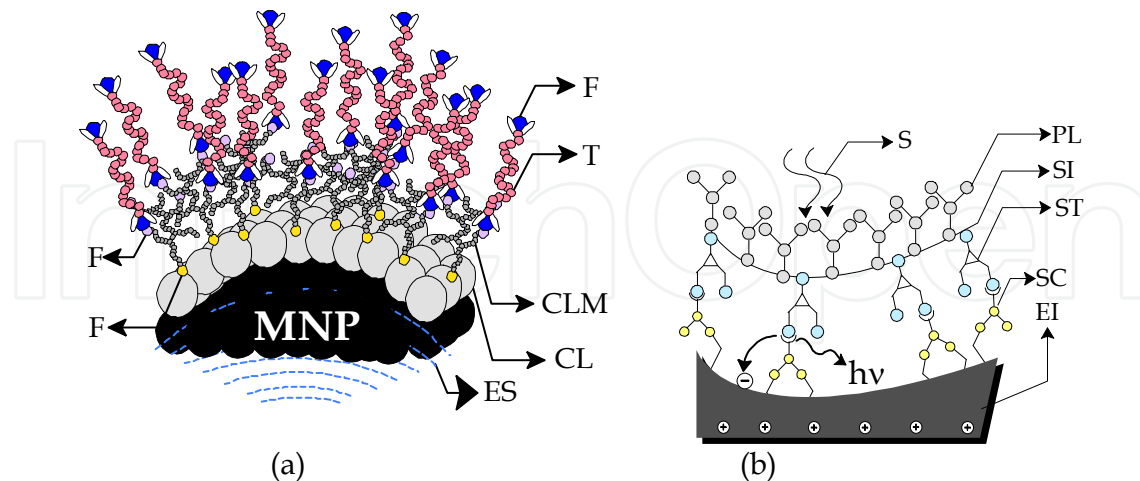

Fig. 1. Some typical examples of nanostructures with orientated functionality (a) Polyfunctional structure with macromolecular separation tasks (ES – external magnetic field stimulus; CL – coated layer; MNP – magnetic nanoparticles; T – target macromolecules; CLM – reticulation molecules; F – functionalities) (b) Functional structure of an interface with sensitization tasks (EI – electric interface; SC – signal carrier; ST – signal transducer; SI – structural interface; PL – protective layer; S – external stimulus)

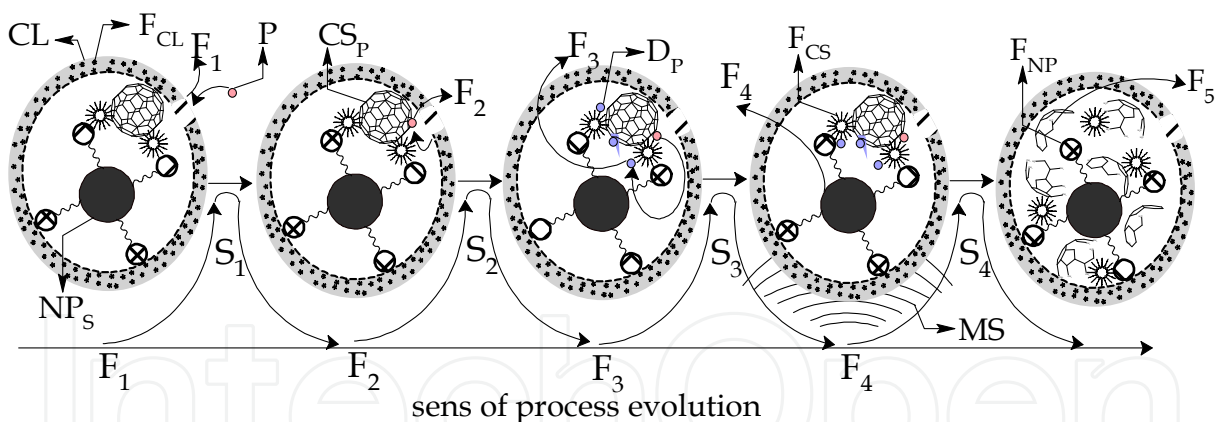

Fig. 2. Typical diagram of an orientated process for controlled separation of organic

Figure 2 presents the functional diagram of a MOF intended for the reticulation, degradation and controlled separation of the organic pollutants in the surface waters. The material obtained by means of controlled functionalising processes was modelled so that it could carry out the nano- and microfiltering (F_1), reticulation (F_2), degradation (F_3), magnetic separation (F_4) and biodegradation (F_5) functions of the organic pollutants in the surface waters, containing chemical functionalities of the aminated, hydroxylated, carboxylated, phenolated, carbonylated, thiolated and halogenated types, derivatives or chemical structures having mixed functionality. In phase S_1 , the material comes in contact with the pollutants (P), reticulating them at the level of the functional structures of the CL and CS_P structural components of the composite. CL carries out the composing functions of the CS_P

and NP_5 structural elements (fig.2) and the filtering functions at molecular level of the contaminated water. In order to carry out the reticulation function of the pollutants, the CL, CS_P and NP_5 structural components have been chemically functionalized with glutaraldehyde (F_{CS}) and epyclorhidrine (F_{CL}), so that, we might obtain, by means of a compositing process, a material having a nanometric porous structure and usable in the molecular filtering processes (fig.2). The pollutants' reticulation (F_2) at the level of the three structural components takes place in S_2 phase, each of them separating a certain category and type of target pollutants. Following the reticulation processes, it is likely that the reticulated pollutants should be partially or totally degraded, as a result of the chemical crosslinking interactions holding between the functional groups and the pollutants. The degradation function of the pollutants (D_P) is carried out at the level of all the structural elements of M_{OF} , and is due to the polyfunctional structure and to the nano- and micro-fiberlike morphostructure of the composite. In order to degrade the pollutants (F_3), M_{OF} was functionalized and composited, so that, due to the density of functional groups and due to the space distribution of its structural components, nano and microchannel structures may be formed, which may degrade and encapsulate the pollutants and the resulting degradation products, without offering the possibility for them to escape in the filtered environment. The controlled separation process of the depolluting products is done by means of the F_4 function, carried out by the NP_5 nanostructural component.

NP_5 contains Fe_3O_4 nanoparticles functionalized with glutaraldehyde, which assures the separation of the composite filled with pollutants. These nanoparticles can be stimulated, in order to be separated in a controlled manner, by means of an external magnetic field (MS) (fig.2). The NP_5 structural component can reticulate organic pollutants that have chemical aminated functions, by means of the F_{NP} functional structure.

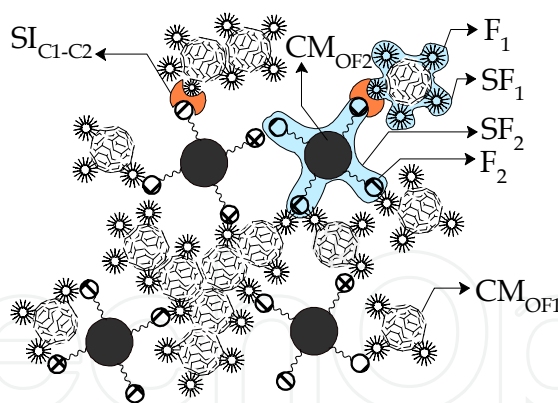

Fig. 3. Typical structural and interfacing diagram of a composite material (CM_{OF1} , M_{OF2} - component material phase of M_{OF} ; F_1 , F_2 - functional elements of CM_{OF} ; SF_1 , SF_2 - microsurfaces distributions of functionalities; SI_{Cl-C2} - compositing interfaces of CM_{OF})

The biodegradation function (F_5) is the result of the appropriate modelling of the morphological and morphochemical structure of M_{OF} , so that, when the composite charged with pollutants is exposed to the environment factors, it might be degraded and assimilated, without modifying the structure and the functionality of the environment. The CL structural component encapsulates the reticulated pollutants and the degradation products, so that the environment may assimilate more easily the M_{OF} charged with pollutants, without generating short or long term toxic effects.

There is not a well defined limit between the intelligent materials and the functionalized materials, as in both cases material structures which are “programmed” to execute pre-settled tasks are involved. The polyvalent functionalization of M_{OF} involves the discretization of the obtaining processes, the carrier material phases being integrated in stages and by different processes. The most sensitive stage in the obtaining process of M_{OF} involves the preserving and quantification of the functional structure and of the carried out functions, so that they are not lost, masked or modified, following the compositing processes. The preservation and quantification of the functionality need the interposition of material phase connection, which should link the material structures that enter the composites structure (CM_{OF}) (fig.3). These connecting structures are called interface structures (IS) and have the role to protect and connect each structural component, as well as to preserve their functions. IS (fig.1) establish transition microregions between structural components (fig.3), the most widespread being the chemical interfaces.

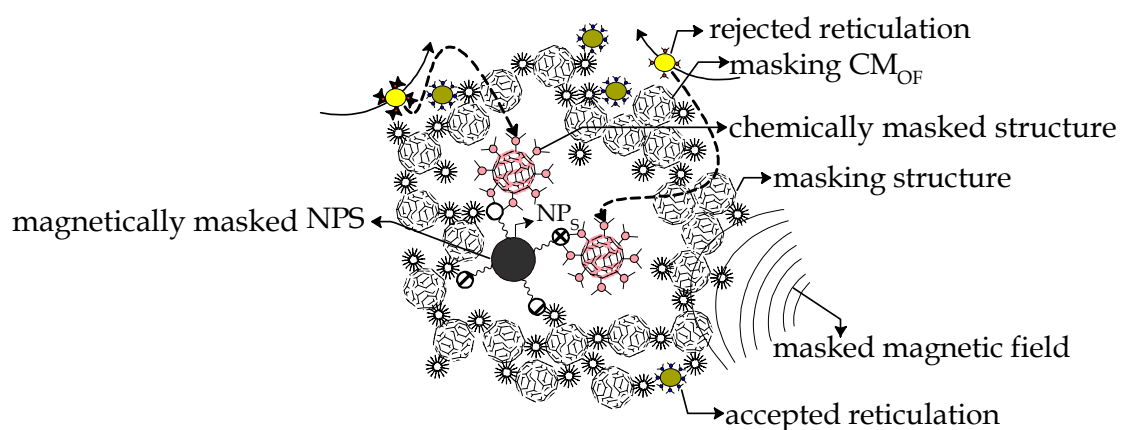

Fig. 4. General mechanism for functional structure masking of polyfunctionalized M_{OF}

Chemical interfaces favour the interposition between two homogenous material phases, different in point of structure and physicochemical properties of the functional groups, coated layers or molecular phases. As it is difficult to find the structural interface which may realise, at the same time, the connecting and preserving functions of the functionality, in most cases, between the nanomaterial composites and its structural components, molecular layers interpose to meet one of the two imposed conditions. Depending on the application and the type of functionalised composite, IS has an important role in stabilizing the morphochemical and morphostructural functionality by establishing complex physicochemical equilibria, which influence the dielectric structure, chemical and thermal stability, electric conductivity, magnetic moment, radiative stimulation, molecular diffusion, etc. The dimensions, the morphological structure, the morphochemical structure and the manner of distribution of IS are strictly conditioned by the chemical structure of the interfaced material phases and by the functionality we seek to obtain. For instance, in the case of the magnetically stimuable nanostructures, the thickness of the coating layer may affect, by screening, the magnetical separation processes (fig.4). In order to obtain structural interfaces that would not mask or cancel the functionality of the composite, each material structure of the composite is obtained and functionalised separately, following that the compositing processes of the different structural components would be carried out in a controlled manner and in distinct stages. The functionalised nanocomposite materials have

become indispensable tools in most scientific and technological fields, due to the flexibility of the structural and functional modelling mechanisms, as well as due to the available manipulation and control possibilities. Environment science and protection (water depollution, waste control dispersion, water purification, water filtration, etc.), biochemical sensing, detection and nanomedicine are the most promising fields in which this type of materials can be applied.

2. Mono- and polyvalently functionalized nanocomposite materials

By definition, mono- or polyvalently functionalised nanocomposite materials (CM) are the carriers of one or more functionalities. The structural and functional modelling of composites depends on the type of application and functions that the composite must carry out. In depolluting applications, the polyvalently functionalised composites have the advantage that they may be structurally and functionally modelled in an oriented manner, so that they might reticulate, encapsulate and separate a large number of organic pollutants.

2.1 Functional structure modeling of orientated functionalized materials

Chemical functionalization compounds are those chemical compounds able to establish stable polydirectional chemical bonds, not only with the carrier support, but also with the target molecular structure. Some applications (analytical applications, molecular separations, etc.) constrain the use of MOF, imposing that the reticulation processes should not degrade the crosslinked structure. Compounds with high chemical aggressiveness are not proper to be used in the analytical processes of sensitization, reticulation, or macromolecular separation, which are specific to the biological compounds, organic pollutants, nanoprobe, etc. Highly aggressive reticulation chemical compounds can degrade, alter and disperse the morphochemical structure of reticulated target structures.

The most used classes of chemical functionalization compounds are triazines (fig. 5), sulphochlorides (fig.6), periodates (fig.7), cyanate compounds and their derivatives (BrCN, ClCN, hydrazine - fig.8), aldehydes (glutaraldehyde, N-hydroxysuccinimide, benzoquinone, etc. - fig. 9) and the epoxidic compounds (epichlorhydrine - fig. 10).

The glutaraldehyde is the most proper compound to be used in macromolecular functionalizing processes, as it can easily form stable functional structures, which do not degrade reticulated structures. The rest of the functionalization chemical compounds mentioned in the literature (antibodies, biological markers, functionalization compounds for the noble metals or for those with low reactivity, etc.) is characterized by the fact that they are specific to a certain carrier support layer and reticulate a strictly limited spectre of target structures. As functionalizable carrier supports, different types of polymeric nanostructures may be used (cellulose, dextrans, elastomers, glycols, amines, acetamides, etc.), nanostructured elements (oxidic structures, metals, fullerenes, quantum dots, etc.), other nanostructured materials having their surface and depth structure enriched with chemical groups (-H, -OH, -SH, H₂O, etc.) that may establish chemical reticulation reactions. The compositing process of the structural components of composites may take place in one or more stages, depending on the functionality and the assigned functions, in relation to the affinity and chemical stability of each functional component, as well as depending on the morphological and morphochemical structure of the structural components and of the composite we seek to obtain.

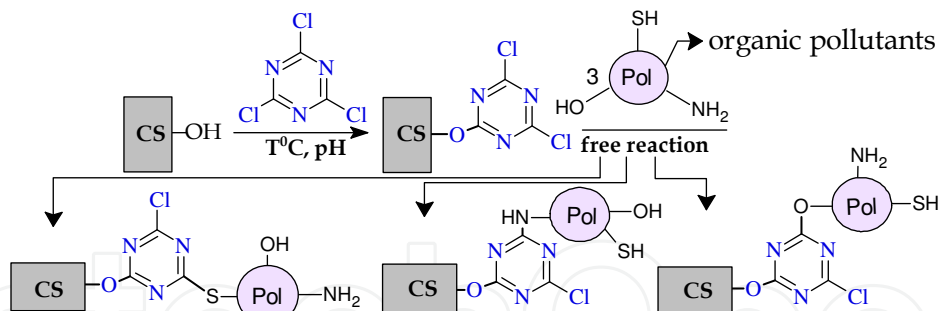

Fig. 5. General mechanisms of the macromolecular reticulation of triazinic-functionalized carrier supports (hidroxy-enriched carrier support)

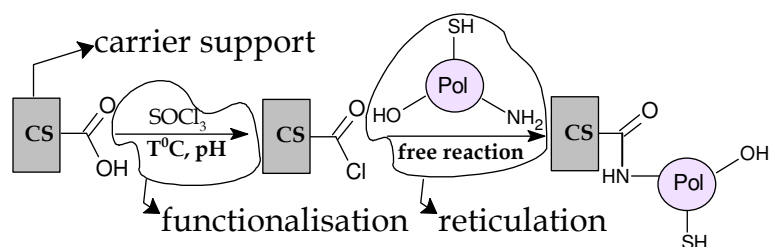

Fig. 6. General mechanisms of the macromolecular reticulation of halidic-functionalized carrier supports (carboxy-enriched carrier support)

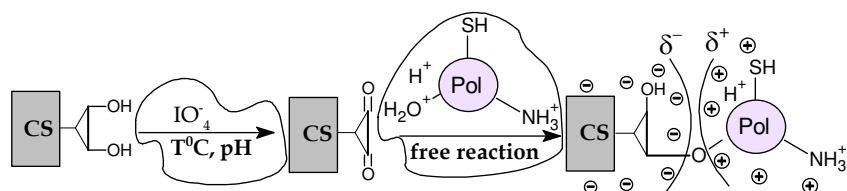

Fig. 7. General mechanisms of the macromolecular reticulation of IO₄⁻-functionalized carrier supports (poliol-enriched carrier support)

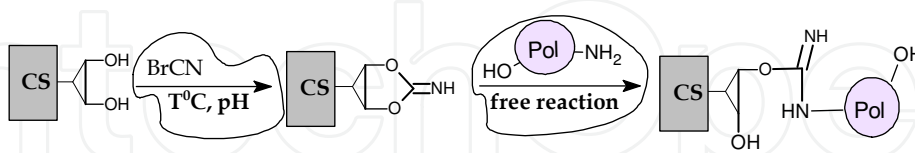

Fig. 8. General mechanisms of the macromolecular reticulation of cyan-functionalized carrier supports (hidroxy-enriched carrier support)

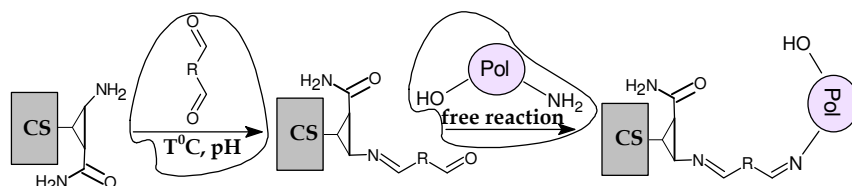

Fig. 9. General mechanisms of the macromolecular reticulation of aldehydic-functionalized carrier supports (amino-enriched carrier support)

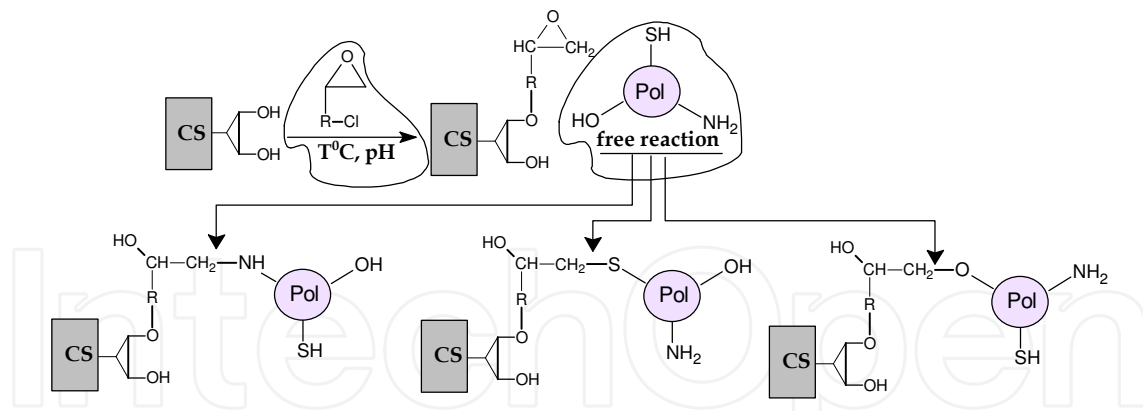

Fig. 10. General mechanisms of the macromolecular reticulation of epoxy-functionalized carrier supports (polyol-enriched carrier support)

2.2 Morphological and morphochemical structure of nanostructured materials

The surface and depth morphological and morphochemical structure of the orientedly functionalized composite materials is radically modelled by the reticulation and self reticulation processes, and by the local physical and chemical processes, established between the structural elements of the composite (self reticulation, induced mechanical tensions, magnetic and electric dipole moments, hydrogen bonds, molecular or atomic reticulation sites) (fig.11).

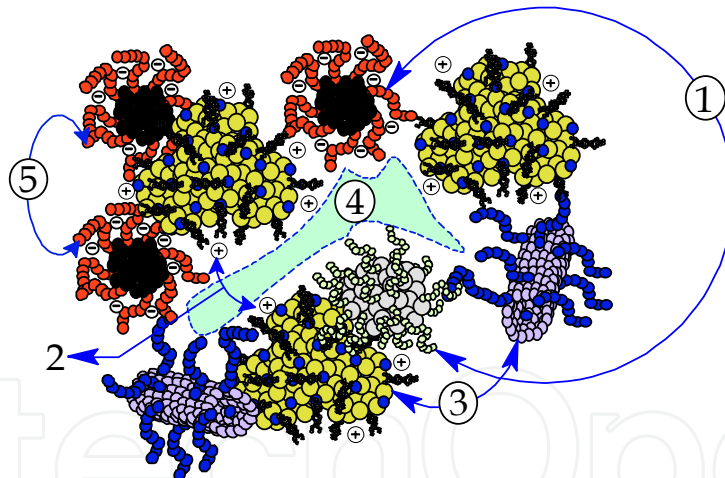

Fig. 11. General mechanisms of the morphological and morphochemical modelling of CM_{OF}
 1 - functional constraints; 2 - charge constraints; 3 - mechanical and morphotopological constraints; 4 - free space; 5 - functional self-constraints

The agglomeration processes are specific both for the nanostructured materials, and for the functionalized nanocomposite materials, due to self reticulation processes, surface impurities, the electrostatic and micromagnetic polarization, superficial tensions between solvents and the dispersed functionalized material. Self reticulation is due to functionalization imperfections, which lead to the formation of ununiformly functionalized surfaces that favour the occurrence of atomic and molecular sites, able to initiate and establish reticulation bonds with the chemical functions of the neighbouring morphostructures. M_{OF} morphology is modelled by the morphology of its structural

component, by the compositing techniques and conditions, by the expression mechanisms of the functionality and by the molecular association processes at a nanotopological level. The functionality and the morphostructure of the structural components are conditioned by the physical and chemical equilibria established between the structural elements of the composite. The morphological structure of MOF may be modelled by choosing the adequate compositing methods (reverse micelle, photolysis, hydrolysis, etc.) and by the strict control of conditions and of the compositing phases (temperature, solvation effects, rate of agitation, etc.). The morphological and morphochemical depth structure of the composites cannot be modified during the compositing process, and the external modelling factors may lead to loosing of the functionality of the composite or of its structural components. Reverse micelle method is the most convenient technique of obtaining nanostructured materials and functionalized composites.

3. Nanostructured material interfaces

Material interfaces (MI) are material structures that favour the stable binding of two or more material structures having different chemical and physical properties. The surface chemical structure of most of the inorganic structures does not bear direct chemical functionalization processes, and the growth of material interfaces is needed (functionalization molecule layers, coating layers) which should favour stable chemical bonds between the involved material structures (fig.12). Impurities, microsurface defects and the reduced reactivity of microspheres are the main elements that condition the functionality of this type of nanostructures. In order to favour the physical and chemical interaction processes between the organic and inorganic material phases, in most cases, a series of processes and chemical compounds are used to modify their surfaces energetically and chemically: silans, acid or basic chemical treatments, chemical passivations, etc.

In the case of high functionalized oriented structure composites, each structural component of the composite needs the deposition of one interfaceable chemical structures having a certain specificity in relation to the rest of the composited structures. Preliminary chemical treatments due to eliminate impurities and to modify the treated microspheres energetically aim to favour chemical reticulation reactions and to obtain uniformly distributed functional interfaces. The elimination of surface impurities is indicated in the case of oxidic nanomaterials and amorphous material structures, whose surface is likely to be impurified with traces of water, hydroxyl groups, metals, ions, etc. The most efficient method to eliminate these impurities from the surface of oxidic structures or of amorphous material structures consists of treating the interest surfaces with acid mixtures (HNO_3 , H_2SO_4 , H_3PO_4) (Lucas et al., 2007). As a result of the acid treatments, part of the treated support structure is partially degraded, and the metals and metal ions are removed. After having carried out the acid treatment, the composite nanoparticles are washed with solvents, which should remove the resulted degradation compounds. In most cases, acid treatments are followed by chemical treatments intended to passivate the modified nanostructures electrostatically. Organometallic salts are usually used (citrate, oxalate, etc.) in order to eliminate the electric charge density induced in the surface structure (Campos et al., 2002).

Prevention of the agglomeration and flocculation processes can be made by introducing some additional repulsion forces, so that the support phase, chemically and energetically modified, should be positioned in a chemical, electrostatic and micromagnetostatic equilibria with the host fluid. The spreading of the ionic phases in aqueous host medium is influenced by the

presence of the residual ions (Na^+ , $(\text{CH}_3)\text{NH}_3^+$, NH_4^+ , NO_3^- , ClO_4^- , etc.) and by the dielectrical intrinsic structure of the cristaline structure of the dispersed phase, establishing electrostatic Van-der-Waals bonds with the amphoteric hydroxyl groups (Campos et al., 2002).

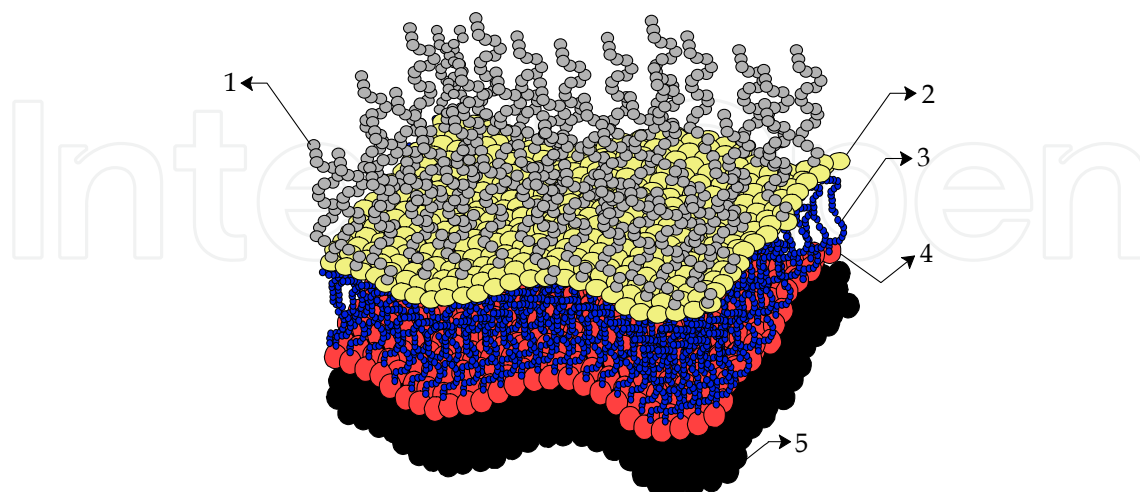

Fig. 12. General morphological and morphochemical structure of material interfaces
1 - crosslinking molecules; 2 - reticulation interface; 3 - organic laid-down coated layer; 4 - energetically and chemically modified surfaces structures; 5 - inorganic substrate

The favouring of dispersion may be done by inducing some negative (dispersion in acid environments) or positive (dispersion in alkaline medium) electric charges at the level of dispersed phase surface (Massart et al., 1995). The dispersion of the inorganic phase in organic host medium (cyclic hydrocarbons, paraffine oils, linear caten hydrocarbons, etc.) involves coating them with an amphiphilic molecule layer, in order to initiate the steric repulsion processes. Molecular reticulation prevention is due to the thermic agitation movement of the terminal hydrocarbons that lead to the formation of specific cristaline structures. The most used surfactants are sodium bis (2-ethylhexyl) sulphosuccinate (AOT), cetyl trimethyl ammonium bromide (CTAB), lipids (lecithin, phosphatidyl glycerol dihexadecyl phosphate, etc.), oleic acid, stearic acid, etc.

Silanes and cyanides are the most indicated chemical agents to modify the nanostructured surfaces chemically and energetically, so that they should establish easily stable chemical bonds with OH-, H-, -O-, M-O and M (M - metal atom) groups found on most of the material structure surfaces. Cyanates compounds (BrCN , ClCN) favorise the forming of a large spectrum of reactive chemical groups on oxidic surfaces, of the type: nitrile: (-CN), isonitrilic, cianamidic ($-(\text{R})_2\text{N-CN}$), azinic (C=N-_2), isocianic ($-\text{N=C=O}$), carbodiimidic (N=C=N), aminated (primar, secondary, tertiary), compounds having nitrogen and mixed functionality. This type of reactive chemical groups have reticulation properties which are similar to those mentioned in figures 5-10. The organofunctional silanes reaction with -OH groups surfaces is a substitution reaction at the silicium atom, resulting silylated surfaces in which the Si atoms fix on the surface by covalent chemical bonds, via oxygen (fig. 13).

These bonds may be established directly or in the presence of water, through of an intermediary silanol. The reactivity of the hydroxilated surfaces with the silans decreases in the following order: $\text{Si-NR}_2 > \text{SiCl} > \text{Si-NH-Si} > \text{Si-O}_2\text{CCH}_3 > \text{Si-OCH}_3 > \text{Si-OCH}_2\text{CH}_3$. Si-O-microsurface bonds are the critical factor that sustains the reaction, not only in aprotic conditions, but also in non aprotic ones.

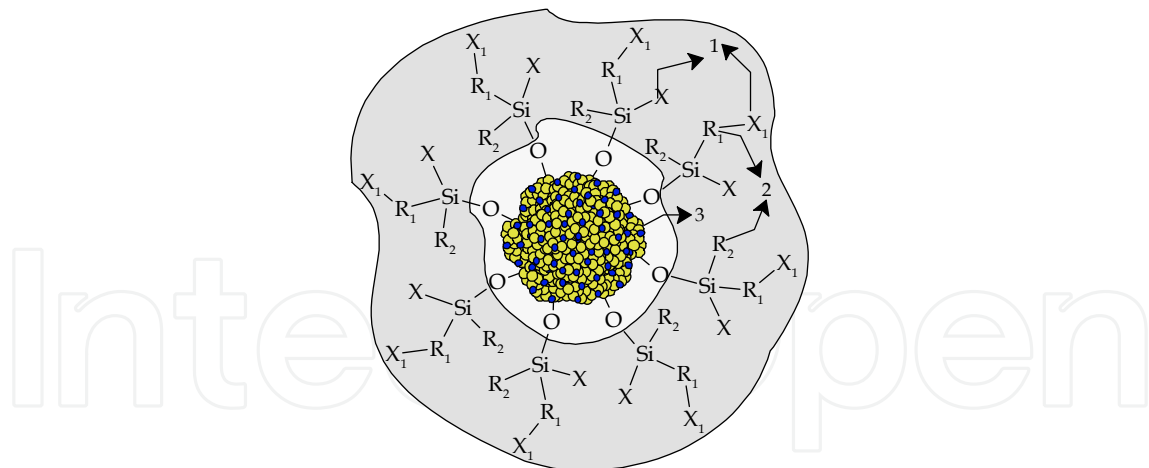

Fig. 13. General structure of an organosilane organic-inorganic interface (1 – hidrolisable functionalities: -OH, NH₂, O-O, etc.; 2 – space linkers; 3 – inorganic modified substrate)

Methoxysilanes are able to sustain reactions with the surfaces from an energetic and chemical modification point of view, not only in aprotic and non aprotic conditions, having lower reactivity compared to the ethoxylans and needing catalytic conditions for sustaining. An important control factor of the physical and chemical characteristics of the chemically modified microspheres is given by the length of the chemical linkers interposed between the organic functionalities and the Si atom fixed on the modified surface, imposing a series of specific chemical reactivity constraints (Jall et al., 2004; Chechik et al., 2000). The organic surface imposes a series of steric limitations on the accessibility of the functional groups which are placed in their vicinity, and the space linkers with appreciable length confer an increased mobility in order to functionalize the entire target surface. Aluminium and titanium form stable surface oxides by hydrolytic processes. Their oxidized surfaces have enough -OH groups to allow the coupling of the organofunctional silanes in the same conditions with those applied to the silicides layers.

Copper, zinc and iron form surface oxides, which are instable from a mechanic and hydrolytic point of view. The reticulation process of the silanes on these types of surfaces involves two or more silanes, one of which is a chelate agent (polyamines, polycarboxylic acids). The second silane is chosen depending on the chemical reactivity of the organic component and on its capacity to initiate condensing reactions with the first silane.

In the case of weak reactive metals (Ni, Au, Pt, etc.), the reticulation of silanes on their surface involves the formation of coordinative bonds (phosphines, mercapto, amino-functionalized silanes). In order to do this, a second silane must be used, which may present reactivity towards the organic component. Titan, zirconium and nickel form stable hydrides. The ability of several metals to form amorphous alloys with hydrogen is exploited in order to adsorb and coordinate the silicon hydrides on the metal surface. The functionalization hydride of silanes and the treated surface of the metal release hydrogen in the presence of bases or noble metals.

4. Physical and chemical properties of functionalized nanosurfaces

Nanocomposites and nanostructured functionalised materials are those materials which carry their own chemical and physical properties, showing them in their next vicinity. The physical and chemical characteristics of structural components and of their composites

depend completely on how they have been obtained: precursors, solvents, physical and chemical properties of the structural interfaces, temperature, pH, etc. The main processes responsible for the morphostructural, morphochemical and morphofunctional modification of depth material interfaces are: a. chemical or electrostatic adsorption sites of: neighbouring molecular radicals, metallic ions, molecules with high diffusion degree and small molecular mass (fig.14); b. hydrogen bonds or other similar chemical bonds (fig.14); c. the type, density and length of molecular space-linkers (fig.14); d. the type of chemical bonds established by the material interfaces with the organic and/or inorganic interfaced structures.

In the case of organosilanic interfaces, the chemical and electrostatic sites are due to functional groups of silane which carry out functions in the reticulation of the target structures and in the molecular or atomic sites which possess electric dipole moment. The structural modelling process is a dynamic one, taking place in the phase of nucleation of the organosilane sites and at the level of the growing surface of the laid-down functionalization interface. As a direct consequence, micro- and nanostructures empty sites (space) are generated in the depth structure, favouring the diffusion of charged ions and of the structures with lower molecular mass (fig.14). The impurities reticulated in the depth structure come from the reaction medium, as most silanization processes are catalyzed processes (alcohols, NH_4OH , etc.), that may generate in the reaction medium different molecular structures ($\text{R}_n\text{Si}(\text{OH})_{4-n}$, $\text{N}^j\text{H}_n(\text{OH})_m$ ($j+n+m=5$), H^+ , $-\text{OH}^-$, H_3O^+ , etc.) that may diffuse and reticulate in the depth of the laid-down functionalized interface. Self assembled monolayer (SAM) material interfaces have the advantage that they suppress morphochemical and morphostructural processes, but they do not present the same variety and functional affinity by comparison with layered material interfaces. The obtaining of layered material interfaces with varied and stable functionality may be an advantage for a series of applications in detoxification, depollution and decontamination, as they may reticulate, encapsulate and host a wide spectrum of toxic compounds in their structure.

Interfaces with high content of hydrogen bonds and chemical bonds with hydrophobic character can reticulate and host large amounts of aminated, carboxylated, hydroxylated, hydration water, active hydrogen sites and molecular radicals. Using silanes of the $\text{NH}_2\text{R}_n\text{-Si}(\text{-O-})_m$ ($n+m = 4$) type in processes of deposition of functionalized interfaces leads to the formation of polymeric silanic structures of the $n[\text{SiO}_{1.5\gamma}\text{-R}(\text{NH}_2)](\text{NH}_2)_{n\delta}$ type, enriched with $-\text{OH}$, amino, free water and reticulated H_3O^+ functional forms (γ characterizes the degree of cohydrolysis of $\text{Si}(\text{-O-})_m$; δ characterizes the amount of aminated groups) (Iordache et al., 2009). The thickness of the laid-down organosilane layer and the amount of reticulated aminated groups depends on the type of the used silane, the cohydrolysis time and the type of the used catalyzer. In the case of F_3O_4 nanoparticles coated with organosilane polymer by cohydrolysis of the (3-aminopropyl)triethoxysilane, functionalized interfaces of the $\text{F}_3\text{O}_4\text{-}n[\text{SiO}_{1.5\gamma}\text{-(CH}_2)_3(\text{NH}_2)](\text{NH}_2)_{n\delta}$ type have been obtained. On the basis of the analysis of the acquired experimental data by energy-dispersive X-ray spectroscopy (tab.1), the growth rate of the coated layer has been determined, as being modelled by the analytic relation (1). The graph representation of the analytic relation (1) is presented in figure 16.

Nano and micro-sites established in the depth of the laid-down organosilane coated layer favour the diffusion of the lower mass molecular compounds, due to the type of space-linkers and to the flexibility of Si-O-Si ($120^\circ < \theta < 180^\circ$) bonds (Tolstoy et al., 2003). This fact is due to the unhydrolyzable character of molecular space-linkers, which orientate the neighbouring hydrolyzable structures depending on the electric dipole moment, the

chemical interaction potential and the mechanic tensions established between them and their neighbouring macromolecules.

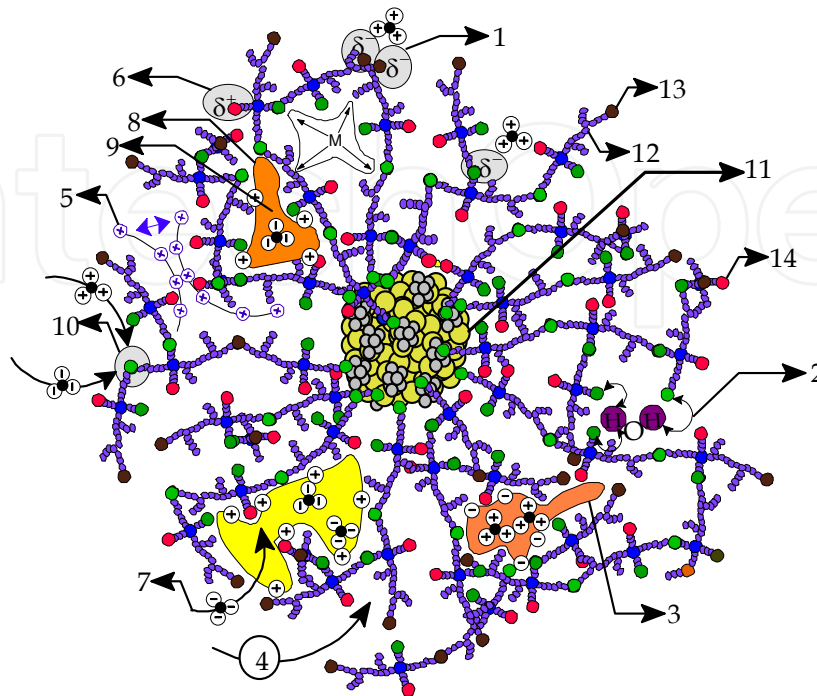

Fig. 14. General physical and chemical mechanisms who model the morphochemical and morphological structure of functionalized nanosurfaces (1 - positively charged molecular radicals; 2 - hydrogen bonds; 3 - free space sites filed with positive charged molecular radicals; 4 - acces pathway for small molecules; 5 - positively charged nanosurfaces; 6 - molecules with strong electric dipole; 7 - negatively charged molecular radicals; 8 - positively charged topological nanosites; 9 - free space for negatively charged molecular radical retaining; 10 - bonds susceptible for breaking; 11 - inorganic interfaced nanostructure; 12 - space linkers; 13 - organic functionality; 14 - space linkers)

The size of the free micro-sites established in the depth of the coated layer has the magnitude of dimensions comparable with that of molecular space-linkers, modelling the mechanic tensions and the charge distribution. Functional organosilane groups (fig.14) could be inserted on the surface and in the depth of interfaced structures, using as silanization agent: silanols, amino silanes, siloxanes, epoxy silanes, carbinolic-functionalized silanes, acrylate/metacrylate-functionalized silanes, carboxy silanes, mercapto silanes or anhydrides-functionalized silanes (Denmark & Sweis, 2002). Functional organosilanic groups may reticulate nucleation macromolecular structures of the $n[\text{SiO}_{1.5\gamma}\text{-RX}]\text{Y}_{n\delta}$ type (X functional silanic group: $-\text{NH}_2$, $-\text{SH}$, OH , $-\text{COOH}$, etc.) or the sites or molecular radicals (Y) in the reaction volume, modifying the morphochemical and morphofunctional distribution, as well as the electric charge density established on surfaces of the deep micro- or nanosites of material interfaces. In the case of the aminosilanes catalyzed by NH_4OH , the following bonds Si-O-Si , Si-NH-Si , $\text{Si-O}(\text{NH}^+_3)\text{-Si}$, SiNH^+_3 , $[\text{M}(\text{NH}_3)_n]^{m+}$, result during the process of the $n[\text{SiO}_{1.5\gamma}\text{-R}(\text{NH}_2)](\text{NH}_2)_{n\delta}$ laid-down coated layer. These bonds can be easily broken by the molecular radicals present in the reaction medium, resulting new types of functional group: Si-OH , Si-NH_2 , etc.

Crt.	N (Wt%)	O (Wt%)	Si(Wt %)	Fe(Wt%)
P1	0.00	60.45	17.62	21.93
P2	1.97	42.10	22.02	33.91
P3	3.93	60.79	8.56	26.72
P4	2.49	51.40	19.08	24.20
P5	2.90	53.09	26.98	13.02
P6	4.06	53.22	14.05	17.74
P7	1.04	55.87	18.47	22.30
P8	3.50	44.06	20.93	13.76

Table 1. Contents of Fe, Si, N and O found on SEM investigated microspheres

$$\ln\{([N] + [Fe])t^2\} - \frac{t}{[Si][Fe] \ln\{([N] + [Fe])t^2\}} = f(t) \quad (1)$$

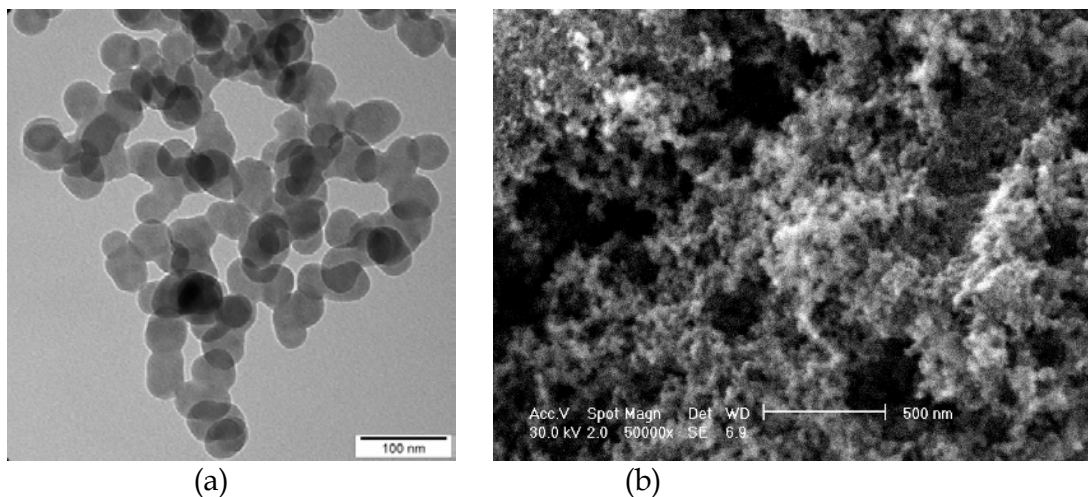
Fig. 15. $\text{Fe}_3\text{O}_4\text{-}n[\text{SiO}_{1.5\gamma}\text{-(CH}_2\text{)}_3\text{(NH}_2\text{)}](\text{NH}_2)_{n\delta}$ nanoparticles
(a) TEM image (180.000x) (b) SEM image

In the case of Fe_3O_4 nanoparticles coated with $n[\text{SiO}_{1.5\gamma}\text{-(CH}_2\text{)}_3\text{(NH}_2\text{)}](\text{NH}_2)_{n\delta}$, the experimental data we have obtained by electronic transmission microscopy (ETM), electronic scanning microscopy (ESM) and EDX prove that the morphostructural and morphochemical modelling takes place at the level of the laid-down organosilane layer and at the level of the $n[\text{SiO}_{1.5\gamma}\text{-(CH}_2\text{)}_3\text{(NH}_2\text{)}](\text{NH}_2)_{n\delta}$ nucleation sites. This fact entails that chemical stabilization and passivation of the laid-down interfaces take place directly during the coating process, by microlocal passivation of nucleation sites and at the level of the growth surface, in the presence of the reaction medium content.

For biochemical reticulation applications, unstable chemical reticulated impurities on the surface and in the depth of coating layers can be removed by washing them with H_2O , NaCl or organometallic salts (citrate), having the role to stabilize the suspension nanoparticles from a chemical and isoelectrical point of view. The obtained suspensions (4%) are used with the pH adjusted to 7÷8 by proper dilution.

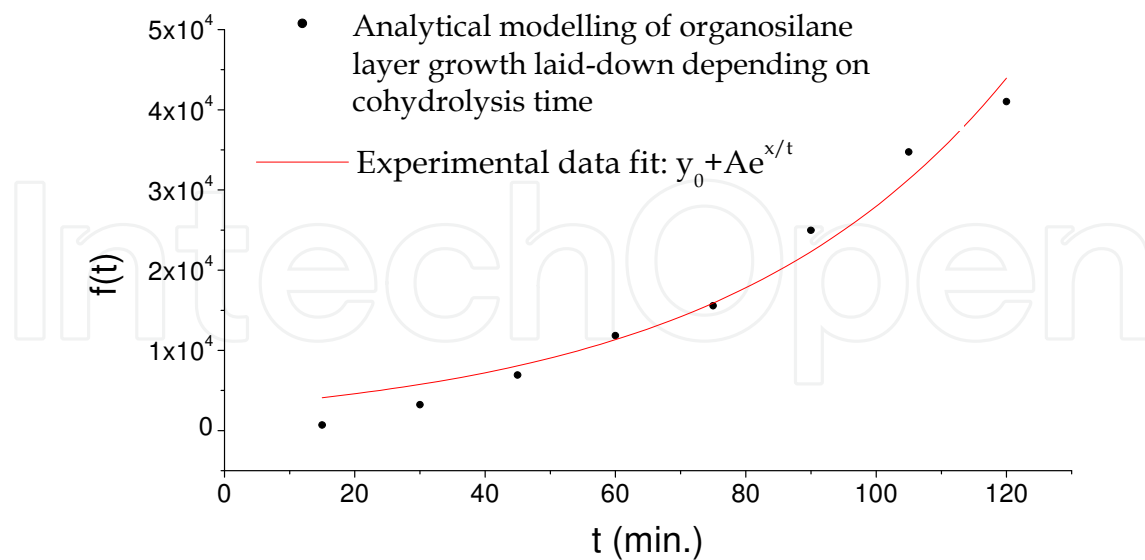

Fig. 16. $f(t)$ function graph

5. External stimutable nanocomposite materials

Externally stimutable nanocomposites represent one of the latest priorities and needs in nanoscience and nanotechnology field, having applications in various fields, such as: chemical and biochemical detection (sensors, differentiated and undifferentiated prelevation of biochemical analytes, etc.) (Festag et al., 2005), nanomedicine (Murcia & Naumann; Bekyarova Haddon & Parpura; Gao; Zheng & Huang; Watanabe & al.; Meziani & al.; Lévy & Doty; Hattory & Maitani; Lellouche; Kommareddy, Shenoy & Amiji; 2005), environment science and protection (depollution, decontamination), chemistry (molecular and macromolecular separation). The stimulation concept designates that way by which a material structure registers a change in its energetic or structural structure under the influence of an external stimulation factor. In this sens, electromagnetic stimulation processes are very well know (fluorescence, phosphorescence, photocatalysis, semiconductor stimulation), magnetic (RMN, RES), radiative (elementary particles, nuclear and molecular radiation). By implementation of some control functions at the level of a stimutable material nanostructure, oriented controlled stimutable nanostructures can be obtained in order to measure, quantify and control the stimutable induced states. Polyvalently functionalized nanocomposite structures are hard to obtain, especially in reticulation applications with targets coming from systems with complex morphochemical and morphostructural, biochemical and biological organisation. Kinematic and dynamic control methods of the stimutable material structures placed in carrier host medium with complex molecular structure are relatively limited and reduced to control by magnetic, electric and electromagnetic stimulation. These nanoparticles have been functionalized so that they should reticulate undifferentiatedly and undestructively the target biological structures, which vary from a morphostructural and morphofunctional point of view.

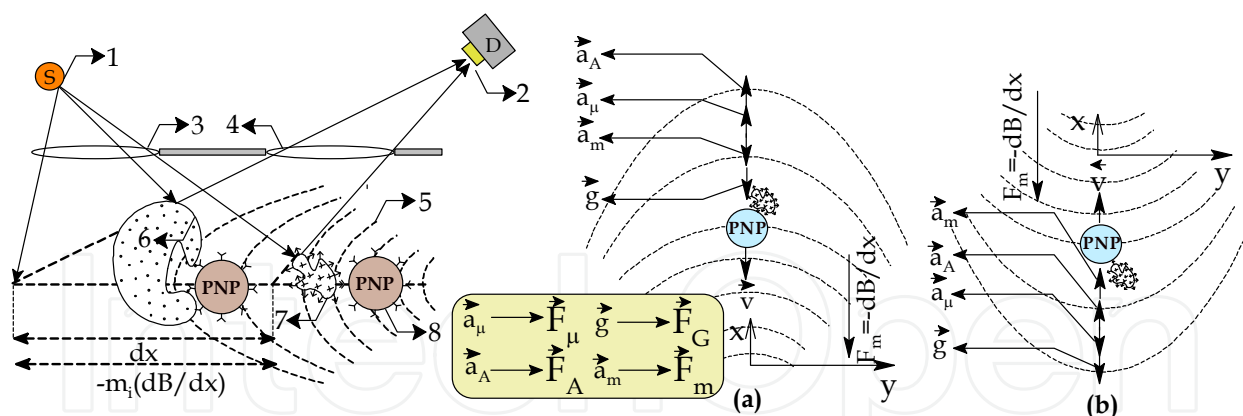

Fig. 17. Diagram of the configuration of constant metric biological detection technique 1 – scan source; 2 – detection sensor; 3 – scan gain; 4 – detector gain; 5 – magneti field stimulus; 6 – reticulated microorganism; 7 – other type of reticulated microorganism; 8 – functionalised magnetic stimuable nanostructure (PNP); M_i – mass of NPB

Analytical techniques with constant metrics use only a stimulation factor for the sensitization of a large spectrum of analytes. Existent analytical methods for biological sensitization (Bhunia, 2008; Jasson, 2010) are variant in respect of a specific required stimulation factor, being unfriendly in respect of sensitization of a large analite spectrum. The analytical method proposed in figure 17 starts from the assumption that the set of values formed by the magnetic moment attached to biochemical structures (m) by reticulation processes and the mass (M) attached to reticulation macrocomplexes are uniquely determined for each type of biochemical structure. As the prelevation and magnetic discrimination processes of the analytes take place in a host carrier fluid, we started from the assumption that the friction force (F_μ), weight force (F_G), archimedic force (F_A) and micromagnetical force (F_m) (fig.17) are the only ones that can model the kinematics and the dynamics of the magnetic dicrimination. In order to reduce the number of the observables and degrees of freedom that affect the kinematics and the dynamics of the Fe_3O_4 nanoparticles reticulated on the surface of the targeted biostructures (NPB), a force field configuration was proposed (fig.17a, fig. 17b), in which NPB movement is orientated, as follows: a. parallel with the gravitational acceleration vector (fig.17.b); b. opposed to the gravitational acceleration vector (fig.17.a). The observables attached to the configured biochemical sensitization process are the specific speeds (v_i) of NPB movement in magnetic field and the specific surface fluorecence of the reticulated biochemical structures (τ_i), so that an univoque analytical relation can be established between the discriminated biostructure and its specific surface macromolecular fluorecence mark. From an analytical point of view, the set of observables (v_i , τ_i) can be correlated by software, so that, for each v_{1i} (a), v_{2i} (b) of sensitized NPB_i , according to the configurations proposed in figure 17, one may identify those sequences that present the same fluorecence mark (τ_i), according to relations (4) and (5). The index „i” designates the type of the sensitized biochemical structure and is defined on the entire reticulation and sensitivization-detection spectrum. Analytical equations (4) and (5) model and describe the proposed constant metric analytical model, which is deducted from fundamental equations (2) and (3), which describe the NPB movement in configurations 17a and 17b.

$$F_{ARH} + F_F = F_{EM-1} + Mg \quad (2)$$

$$F_{EM-2} + F_{ARH} = Mg + F_F \quad (3)$$

where: F_{ARH} is the archimedic force, $F_{EM-1/2}$ are the magnetic field gradients, F_F is the friction force opposed to NPB movement in the host fluid, $F_F = -kx$, M is the mass of NPB.

$$M_{NPB}(i) = 2m \left(\frac{dB_1}{dx_1} - \frac{dB_2}{dx_2} \right) / \sqrt{2c^5 v_f} \left(\frac{1}{x_2} - \frac{1}{2x_1} \right) \quad (4)$$

$$M_{NPB}(i) = m \left(\frac{dB_1}{dx_1} - \frac{dB_2}{dx_2} \right) / \left\{ \frac{\sqrt{2v_2^5 v_f}}{2x_2} + \frac{\sqrt{2v_1^3 v_f}}{2x_1} \ln \frac{v_1 + (v_2 - v_1)e^{\sqrt{\frac{2v_2}{v_f}}}}{v_2} - \frac{\sqrt{2v_1^5 v_f}}{4x_1} \right\} \quad (5)$$

where: dB_1/dx_1 și dB_2/dx_2 are the gradients of the magnetic field realized on the sensitization distance, x_1 and x_2 are the sensitization distances, v_1 and v_2 are the characteristic speeds of each NPB, v_f is the speed of the carrier fluid which hosts the NPB.

In the above mentioned conditions, equation (4) describes those NPB that, following the magnetic acceleration process, achieve a constant speed (c), at the moment of the sensitization of discrimination and for a certain value of the field gradient (dB/dx). Equation (5) is specific for those NPB that, after the magnetic acceleration process, did not achieve a constant limit speed (c). According to equations (4) and (5) it results that analytical methods with invariant metric may be configured for biological detection and monitoring by selective magnetic discrimination. Also, according to these equations, it results that the sensitization domain may be improved by modifying the magnetic field parameters (dB/dx) of the external stimulation factors. The magnetic field represents a convenient method for the undestructive stimulation of magnetic dipole carrier functionalized material structures, which, having a considerable action range, as compared to the rest of the known stimulation factors. Due to the fact that most organic compounds are diamagnetic, the magnetic field substantiates new undestructive selective techniques for controlled stimulation, as the stimuable material nanostructures are not masked by their neighbouring material structures.

6. Structure and functionality modelling of nanocomposite materials designed for undestructive reticulation of biological structures

The functionalization of nanoparticle and nanocomposite structures for biochemical reticulation requires a set of conditions involving: the specificity and the recognition of the reticulated structure, the chemical and functional stability, avoidance of the biochemical interaction with the host carrier, avoidance of self reticulation and agglomeration processes. Most of the applications, especially the analytical one, require undestructive biological and biochemical reticulation in respect to the targeted biochemical structure. Glutaraldehyde is the chemical functionalization and reticulation compound frequently used in the analytical biological process (fig.10), as it presents a weighted chemical aggressiveness and it preserves the internal morphochemical structure of the reticulated structures. Glutaraldehyde is a dialdehyde whose functional molecular residue (CHO) can reticulate undifferentiatedly the hydrogen active, amino- and tiol- sites, present on the surface and in the depth structure of most of biochemical structures. Polyvalent functionalizations require a series of cautions intended for the chemical stabilization of the functionalized nanostructures, so that different

implemented functional groups may not mask or cancel each other's functionality and functions. In order to investigate this aspect, Fe_3O_4 nanoparticles have been coated with $n[\text{SiO}_{1.5\gamma}-(\text{CH}_2)_3(\text{NH}_2)](\text{NH}_2)_{n\delta}$ and functionalized monovalently (with glutaraldehyde - GL) and polyvalently (with glutaraldehyde and epichlorhydrine - GL+ECH) (Iordache et al., 2009). For their morphochemical structure, the following structural relations have been proposed $\text{Fe}_3\text{O}_4 - \{n[\text{SiO}_{1.5\gamma}-(\text{CH}_2)_3(\text{NH}_2)](\text{NH}_2)_{n\delta} - (\text{GL})_{n\epsilon}\} (\text{np}-(\text{GL})_{n\epsilon})$, $(\text{ECH})_{n\beta} - [\text{Fe}_3\text{O}_4 - n[\text{SiO}_{1.5\gamma}-(\text{CH}_2)_3(\text{NH}_2)](\text{NH}_2)_{n\delta}] - (\text{GL})_{n\epsilon}$ ($(\text{ECH})_{n\beta} - (\text{np}-(\text{GL})_{n\epsilon})$) (ϵ and β - modelling coefficients for functional fractions CHO, respectively Cl-C and $-\text{CH}(\text{O})\text{CH}-$) (Iordache et al., 2009). For the functionalization of nanoparticles, 4 grams of chemically stabilized coated nanoparticles have been used (4% suspension), in the presence of 7 ml of glutaraldehyde (25%) ((6)). Polyvalently functionalized particles have been obtained by the functionalization of $\text{np}-(\text{GL})_{n\epsilon}$ with an epichlorhydrine solution, previously prepared (NaOH, H_2O , acetone and 0.5 ml epichlorhydrine) (fig.9).

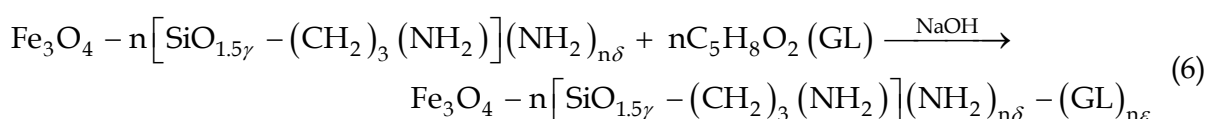

Glutaraldehyde functionalized nanoparticles have been exposed to air in order to investigate the undifferentiated reticulation potential of the saprophyte microorganisms, as the prelevated samples have been investigated by TEM (fig. 18). The same type of investigations has been carried out on *B. Cereus*, *St. Aureus*, *E. Coli*, *Ps Aeruginosa*, and the obtained results have been presented in figure 19. Also, the biochemical reticulation potential of $\text{np}-(\text{GL})_{n\epsilon}$ and $(\text{ECH})_{n\beta} - (\text{np}-(\text{GL})_{n\epsilon})$ has been investigated, by ricin reticulation (Petrea et al., 2009). The samples have been investigated by scanning electron microscopy (fig. 20) and by confocal microscopy (fig.23). Before the investigations were performed by confocal microscopy, the functionalized nanoparticles were marked fluorochromically with rhodamine B, right in the phase of the laying down of the coated layer (cyan color in fig.23). The ricin was marked fluorochromically with fluorescein isothiocyanate (FITC) (green colour in fig.23). The results of the biological and biochemical reticulation investigations have proved that the obtained functionalized nanoparticles present a well defined functionality, and that the morphochemical structure of the reticulated structures has not been degraded (fig.18, fig.19).

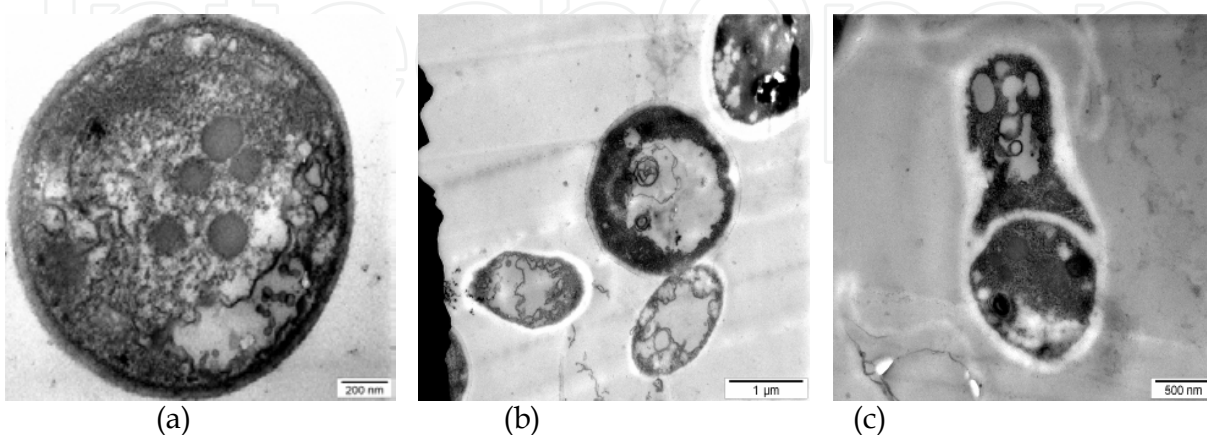

Fig. 18. Investigation images of the $\text{np}-(\text{GL})_{n\epsilon}$ biochemical reticulation potential on saprophyte microorganisms (images acquired by Philips S208 TEM microscope)

It was observed that $\text{np}-(\text{GL})_{\text{ne}}$ are specifically distributed on the reticulated surfaces, according to the surface morphochemical structure of microorganisms. Most likely, distribution maps of the reticulated nanoparticles follow the patterns of the morphochemical distribution of aminated, thiolated, carboxylated, and carbonilated functional groups placed on the surface of microorganisms. The obtained data emphasize the $\text{np}-(\text{GL})_{\text{ne}}$ potential in the field of specific biochemical reticulation, as nanoprobes, or in the field of undestructive biochemical investigation (fig.18).

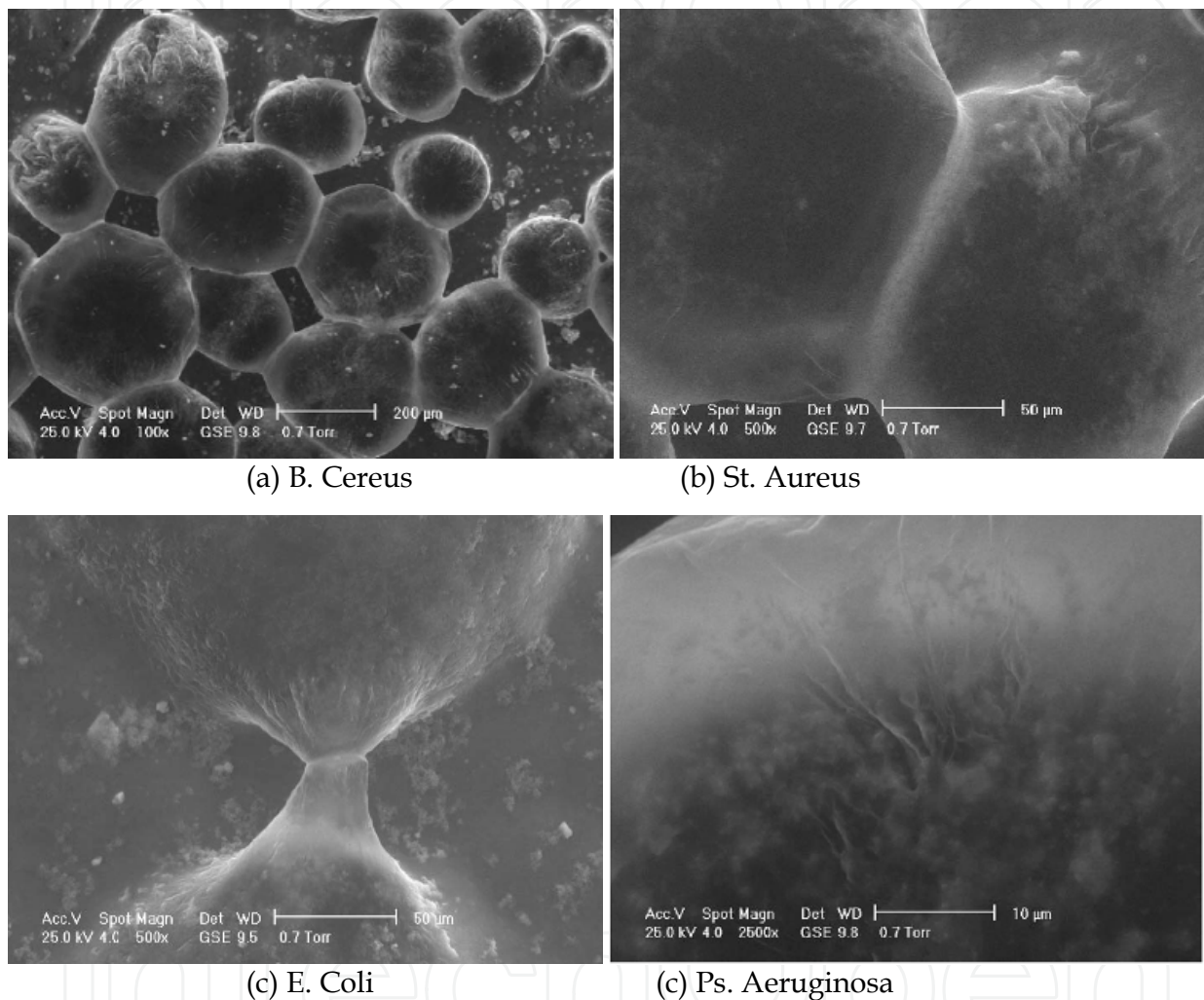

Fig. 19. Investigation images of $\text{np}-(\text{GL})_{\text{ne}}$ biochemical reticulation potential on B. Cereus, St. Aureus, E. Coli, Ps. Aeruginosa (images acquired by ESEM XL30 SEM microscope)

Using the elementary morphological segmentation method (Iordache et al., 2009), in order to determine the elementary morphostructural parameters, it was proved that the main agglomeration mechanism is micromagnetic. Also, it was proved that the functional structure of the obtained functionalized nanoparticle suspension is stable, and it does not initiate self-reticulation bonds. In the case of $\text{np}-(\text{GL})_{\text{ne}}$ and $(\text{ECH})_{\text{n}\beta}\text{-np}-(\text{GL})_{\text{ne}}$, which include Fe_3O_4 nanoparticles obtained by coprecipitation, the agglomeration domains present a spherical form (fig.20a, fig.20d, fig.21b). In the case of functionalized particles containing Fe_3O_4 obtained by reverse micelle technique, the agglomeration domains present an acicular form (fig.20b, fig.20c, fig.21a). These results prove the polyvalent functional structure of

$(\text{ECH})_{n\beta}\text{-np-(GL)}_{n\epsilon}$, according to the specific functionalization mechanisms proposed in figure 22b.

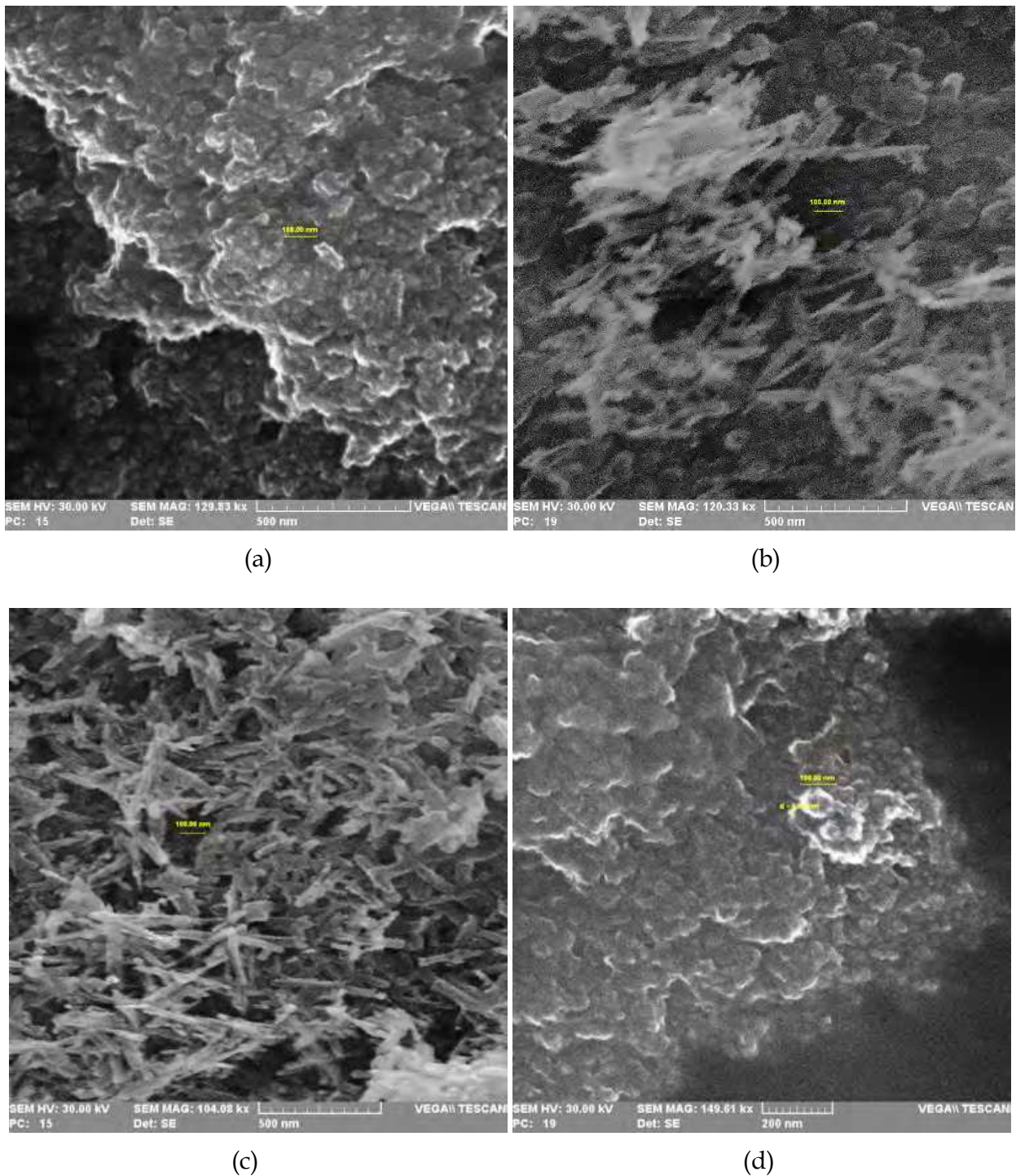

Fig. 20. Investigation images of $(\text{ECH})_{n\beta}\text{-npa-(GL)}_{n\epsilon}$ and $\text{npa-(GL)}_{n\epsilon}$ biochemical reticulation potential on ricin (images acquired by VEGA II LMU SEM microscope) (a) $\text{np-(GL)}_{n\epsilon}$ (Fe_3O_4 obtained by coprecipitation) (b) $\text{np-(GL)}_{n\epsilon}$ (Fe_3O_4 obtained by reverse micelle) (c) $(\text{ECH})_{n\beta}\text{-np-(GL)}_{n\epsilon}$ (Fe_3O_4 obtained by reverse micelle) (d) $(\text{ECH})_{n\beta}\text{-np-(GL)}_{n\epsilon}$ (Fe_3O_4 obtained by coprecipitation)

Reticulation investigations carried out on ricin have proved that there is no significant difference between the reticulation mechanisms of microorganisms and those of ricin. Ricin reticulation tests have proved that the reticulation processes specific to toxins are degenerated, and a single functionalized nanoparticle crosslinks more macromolecules on ricin by contiguity.

The results demonstrate that the morphological and morphochemical structure of macromolecular biological structures play an important role in the evolution of reticulation processes, conditioning the mechanisms and their specificity, as well as the morphological and morphochemical structure, physicochemical properties and the stability of the resulted agglomeration domains. Morphochemical structure relations and the proposed functionalization mechanisms (fig.22) have been deduced by taking into account the obtaining conditions of the structure functionalities and the experimental data acquired during the chemical and biochemical reticulation investigation processes. Chemical and functional stability of the functionalized nanoparticle suspension, as well as the uniformity and the specificity of the biochemical reticulation processes, can be explained only if we accept the fact that the layer of functionalizing molecules, laid down on the coated layer, is continuous and uniform.

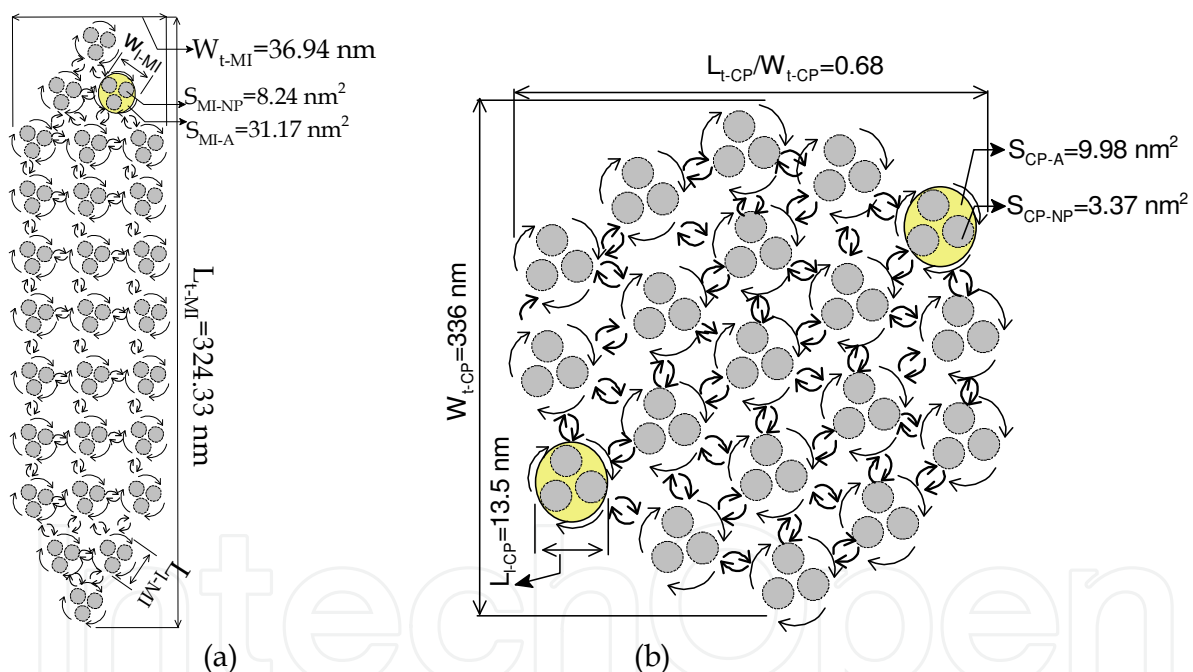

Fig. 21. The adopted elementary and bulk morphostructure domains for (a) $(ECH)_{n\beta}\text{-np-(GL)}_{n\epsilon} (Fe_3O_4 \rightarrow MI)$ și (b) $(ECH)_{n\beta}\text{-np-(GL)}_{n\epsilon} (Fe_3O_4 \rightarrow CP)$ reticulated nanoparticles on ricin surface (W_t, W_l, L_t, L_l = geometrical dimension of elementary and bulk domains)

The discontinuities on the functional structure of surfaces involve the existence of more different biochemical reticulation sites, favouring self-reticulation processes of nanoparticles in suspension. The acquired experimental data disprove the existence of masking, neutralisation or repeal processes between the CHO, CCl or CH(O)CH functional groups. Most likely, a stable chemical equilibrium is established between the CHO, CCl and CH(O)CH functional groups, as they are distributed on the surface of functionalized nanoparticles, according to a well determined morphochemical distribution map.

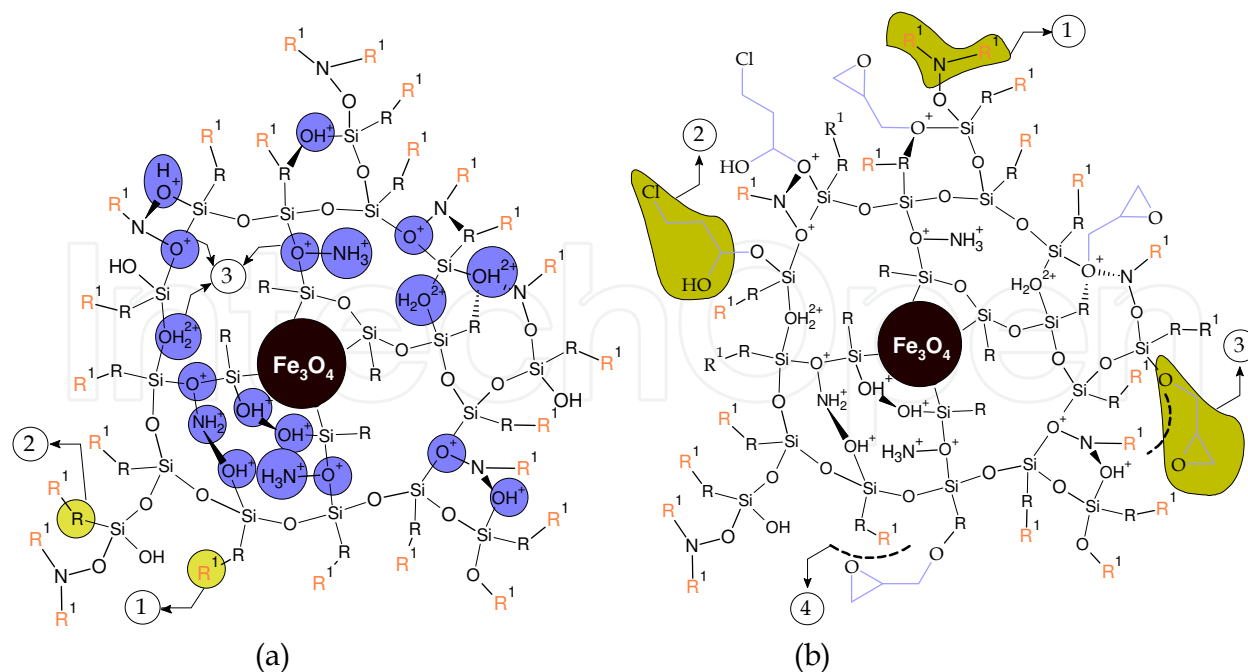

Fig. 22. Proposed morphochemical and morphofunctional structure for (a) $\text{npa}-(\text{GL})_{\text{ne}}$ and (b) $(\text{ECH})_{\text{n}\beta}\text{-np}-(\text{GL})_{\text{ne}}$ nanoparticles ((a): 1 - GL; 2 - propylamine chemical residues; 3 - the most probable morphochemical distribution of chemical functionalities in the depth of coated layer; (b): 1 - CHO functionalities; 2 - Cl functionalities; 3 - epoxy functionalities; 4 - masked CHO functionalities)

7. Structure and functionality modelling of nanocomposites intended for ecological depollution

Research in the waste water and solid waste management usually encounters three main challenging problems: the huge quantities to be processed, the large varieties of contaminants and impurities, and the conversion of solid residuals coming from specific treatments into chemically and biologically inert materials for their safe disposal. Additionally, the useful compounds recycling are preferential design target for most of researches, but in many cases the safe disposal of inactivated residuals is prevailing. In spite of the many advances in waste water treatment, the problem of removal the organic pollutants is still pending around the elaborated technologies developed under the tertiary waste waters treatment concept. Thus, oxidative technologies are expensive and degradation products are still polluting (Gogate & Pandit, 2004). Flocculation and coagulation (Cheremisinoff, 2002) as well as ionic exchange technologies (Robinson & al., 2001), are limited in their efficiency for the removal of organic compounds. Chlorination is often use in the treatment of organic polluted waters, but its drawback is well known, when a large number of pollutants are converted into other compounds with the same toxicity. Microbiological technologies (Tedder & Pohland, 1990) and photocatalytic technologies (Hashimoto & al., 2005) are very selective ones and totally inappropriate for a broad spectrum of organic pollutants in the treated waste waters. Membrane materials (Cassano & al., 2001), particulate nanomaterials and functionalized hybrid nanomaterials as well as functionalized composite material adsorbents seems to be the best solutions for treatment of waste waters highly contaminated with a large number of organic compounds from different classes. Only the prices of these materials are restrictive for

their application at larger scale. The main factors that restrict depollution methods and technologies of surface waters charged with organic pollutants are due to: a. a great number (spectrum) of organic pollutants (OP) contained by contaminated waters; b. morphostructural and morphofunctional varieties of pollutants; c. dispersion mechanisms of pollutants in the environment; d. lack of controlled separation possibilities of pollutants from the source of pollution; e. lack of control upon degrading products, resulted during depollution processes; f. collecting, stocking, storage and management depollution waste.

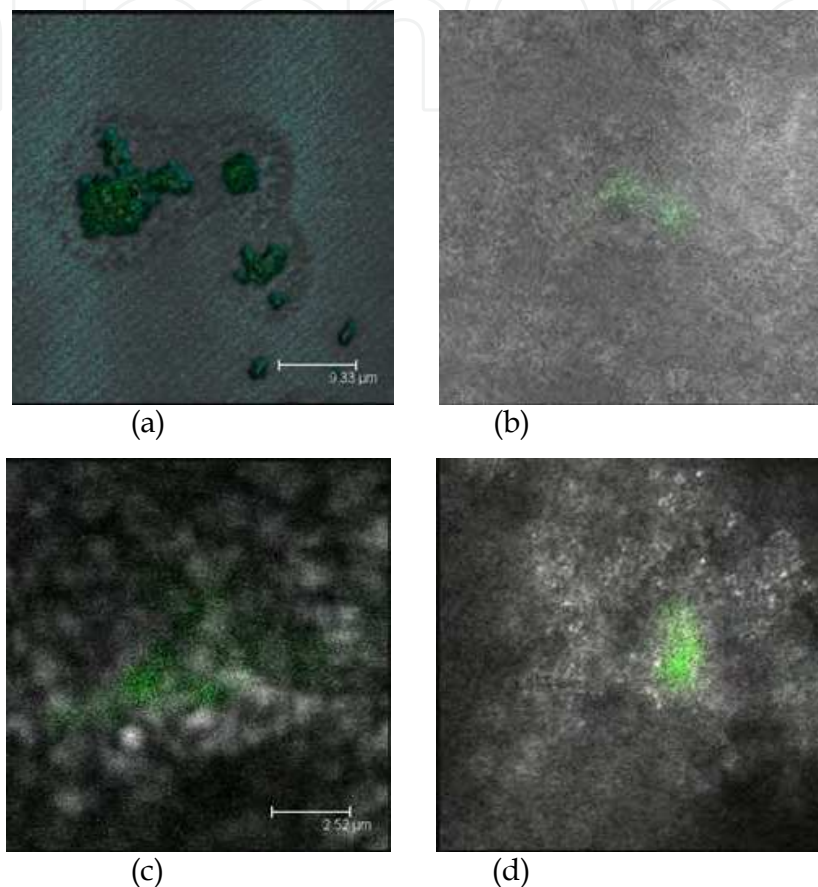

Fig. 23. Investigation images of $(ECH)_{n\beta}$ -np-(GL)_{ne} and np-(GL)_{ne} biochemical reticulation potential on ricin (confocal investigation using a multifoton broadband Leica TCS SP 2 microscope) (a) np-(GL)_{ne} (Fe₃O₄ obtained by coprecipitation) (b) $(ECH)_{n\beta}$ -np-(GL)_{ne} (Fe₃O₄ obtained by coprecipitation) (c) np-(GL)_{ne} (Fe₃O₄ obtained by reverse micelle) (d) $(ECH)_{n\beta}$ -npa-(GL)_{ne} (Fe₃O₄ obtained by reverse micelle)

The spectrum and the morphostructural and morphofunctional variety (SVM) specific to the content of organic pollutants are due to the variety and diversity of the materials used in industrial and domestic activities. SVM limitation, control and determination is a complex issue, which cannot be solved by conventional procedures, as it is conditioned by the exigence, necessities and material needs of the society. From the point of view of the morphochemical type and variety, surface contaminated waters contain inorganic pollutants (salts and metal derivates, mineral acid salts, mixed composition suspensions and amorphous material structures, simple metallic oxides, mixed metallic oxides, etc.), carrier vectors of radioactive elements, organic pollutants (hydrocarbons, alcohols, phenols, dervivates of benzen, organic acids and their derivates, carbonylic compounds and their

derivates, amines, organic halogens and their derviates, aromatic derivates, organometallic compounds, detergents, etc.), biological pollutans (bacteria, viruses) and biochemical pollutants (toxines, proteins, peptines, sugar, etc.) (Evangelhelou, 1998). Most of the organic pollutants degradate in time, generating other polluting compounds that may present high toxicity. Not only the organic pollutants, but also their degradation products, may affect on long and medium term human health and the functionality of the environment.

The dispersion and the diffusion of pollutants is constrained by their physical and chemical properties. Once introduced in the external water circuit, pollutants become uncontrollably, randomly and irreversibly dispersed on wide surfaces. Due to the complexity of the above mentioned factors, the separation processes of the organic pollutants in surface waters and industrial contaminated flux water will be carried out incrementally, using complex technologies and solutions. In most cases, separation processes are only realised partially, as used tehnologies and materials are oriented towards the removal of certain pollutants or of some limited classes of organic pollutants.

Oxidic materials with oriented functional structure (M_{OF}) offer promising development and new implementing solutions for the development of new methods to control depollution of contaminated waters, due to the modelling possibilities of functional structure, and to extend the spectrum of separate pollutants.

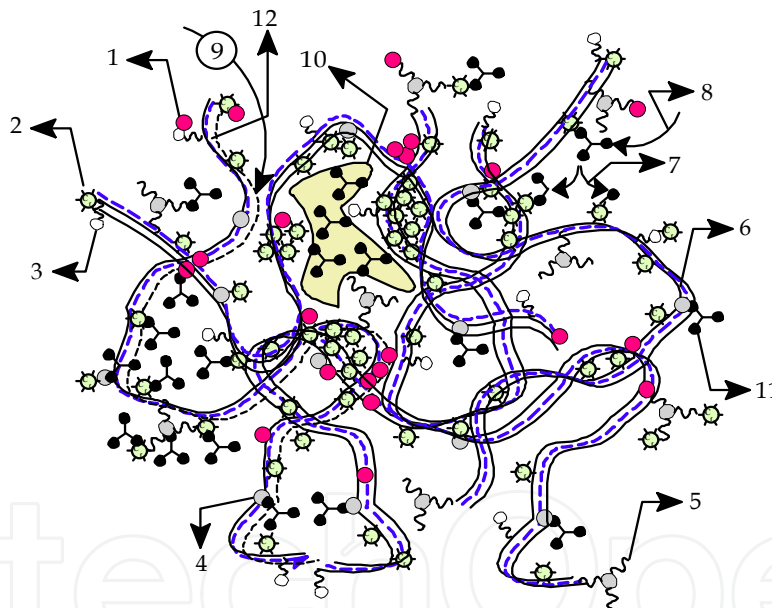

Fig. 24. General mechanisms for the retention, degradation and encapsulation of pollutants 1 - Su; 2 - functionalised magnetite; 3 - OH functional groups; 4 - amino-functionalities; 5 - epoxy-functionalities; 6 - fiberlike cellulose; 7- ways of pollutant degradation; 8 - retention of pollutants; 9 - paths for pollutant diffusion in the depth of composites; 10 - free space for encapsulation; 11 - pollutants; 12 - paths of pollutant host carrier in the depth of composite

M_{OF} separated pollutants spectrum depends directly on the type, polyvalency and stability of the obtained functional structure. Natural oxidic materials, with mixed nanostructures are the ideal candidates in order to obtain polyvalently functionalized materials, due to the complexity of the surface chemical structure, rich in reactive molecular fractions: $-O-M$, $M-OH$, H , $-O-O-$, hydrolizable molecular residue, electrically charged sites, embedded organic compounds, etc. Moreover, for the applications involving depollution, as well as for the

obtaining and functionalization of M_{OF} , there is no need for special chemical and technological conditions, as their usability is constrained by the enrichment and the stabilization of the functionality structure. The stability of this type of materials involves the morphochemical and morphofunctional stability, in order to preserve the morphostructural, morphochemical and morphofunctional characteristics, as well as to prevent the degradation of the support material, carrier for the reticulated pollutants.

In most depollution situations, the chemical and morphostructural stabilization of the functionalized composites is done under water, so that the depolluting applications are conditioned by the possibility of the composite to reticulate the pollutants in free chemical conditions (fig.5÷10). According to the above proposed morphostructural and morphofunctional modelling mechanisms, a polyvalently functionalized composite has been obtained. This composite integrates in its structure a mixture of natural oxides (Su), functionalized with BrCN (~100 grams, about 10 grams of $np-(GL)_{ne}$ nanoparticles and 100 grams of cellulose acetate functionalized with epichlorohidrine ((7)). The chemical composition of Su was determined by Wavelength Dispersive X-ray Fluorescence (WDXRF), and it was found that Su contains the following main fractions: SiO_2 (70.13%), Al_2O_3 (14.33%), Fe_2O_3 (4.36%), K_2O (2.78%), Na_2O (0.46%), MgO (0.87%), P_2O_5 (0.26%), TiO_2 (0.58%), CaO (0.87%).

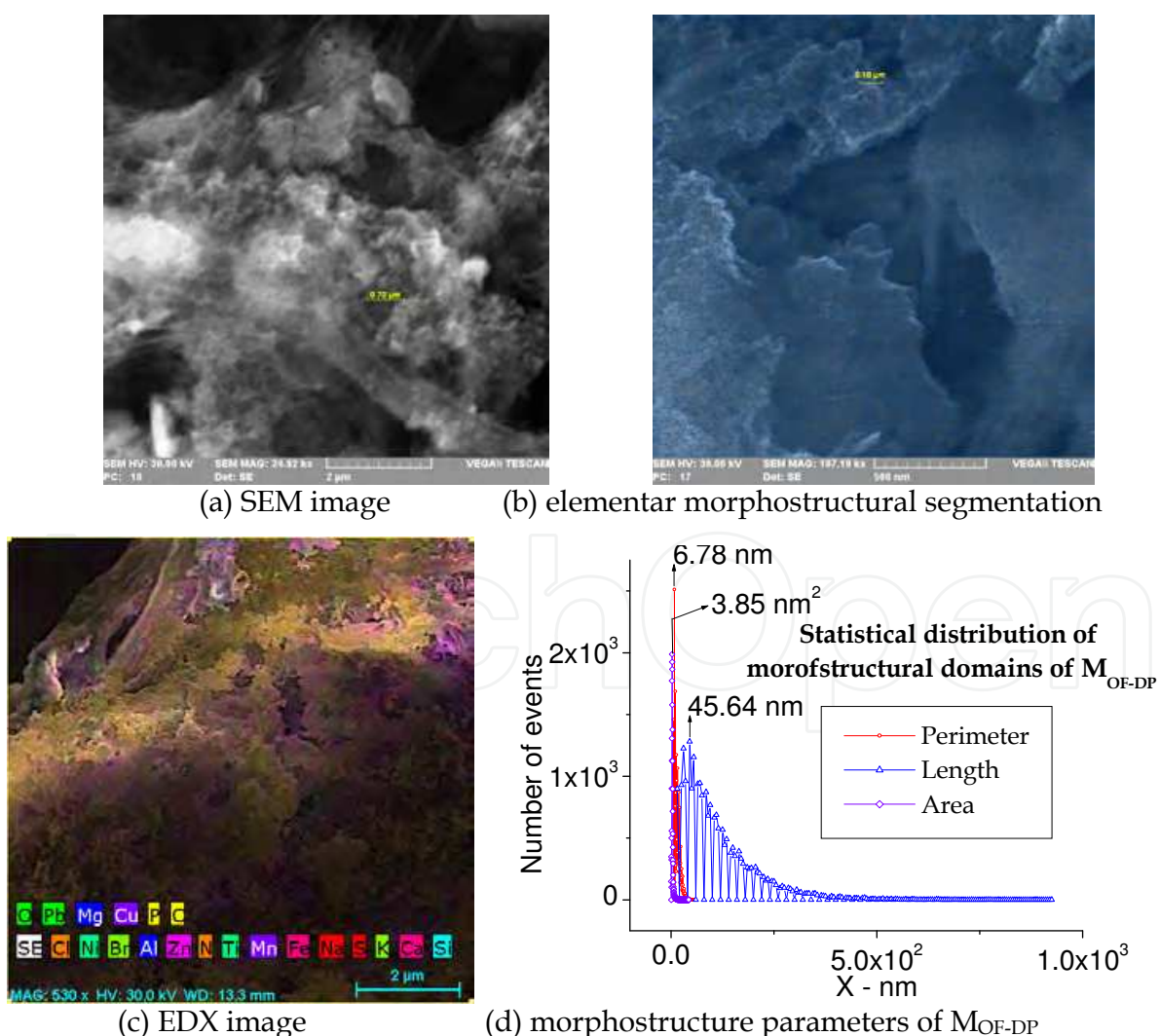
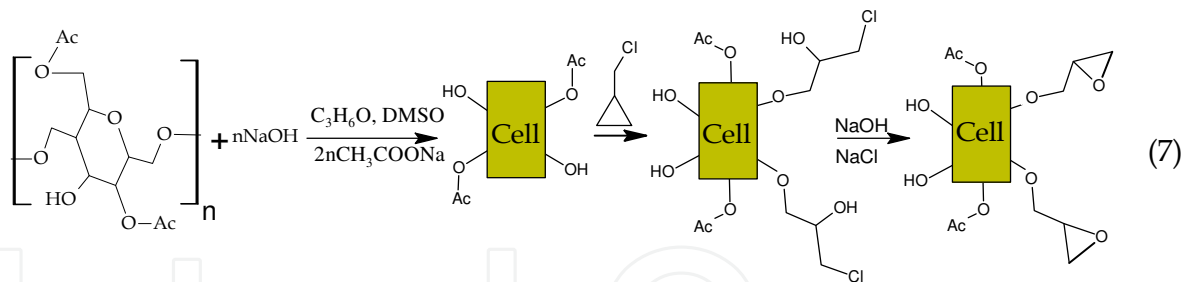

Fig. 25. Morphological and morphochemical structure of M_{OF-DP}



The composite presents a nano- fiberlike character (fig.24, fig.25a), due to the nano- and microstructural character of the water regenerated cellulose. Functionalized cellulose acetate performs the reticulation, compositing and spatial distribution functions of the Su and functionalized magnetite, as structural components. The structural elements of the composite are spatially distributed, on the surface and in the depth of cellulose microfibrils, so that they lead to the formation of nano- and micro-membranary structures. Using the elementary segmentation method (fig.25b), the mean distribution values of the elementary morphostructural parameters have been determined: perimeter (6.78 nm), length (17 ÷ 924 nm), area (3.85 nm²) (fig.25d). The morphostructural character of the nanocomposite allows that the contaminated water may be filtered, at molecular level, from a mechanic, chemical, biochemical and biological point of view, according to the reticulation, degradation, and encapsulation mechanisms proposed in figure 24. It was noticed that the composite allows the development of the saprophyte bacteria on its surface (fig.26), and points out the stable character of the material functionality and the biodegradability of its composite structure. Moreover, the biodegradable nature of the composite is also given by the nature of its composite structure, as its structural elements can be assimilated without inducing toxic effects in relation to the structure and functionality of the environment.

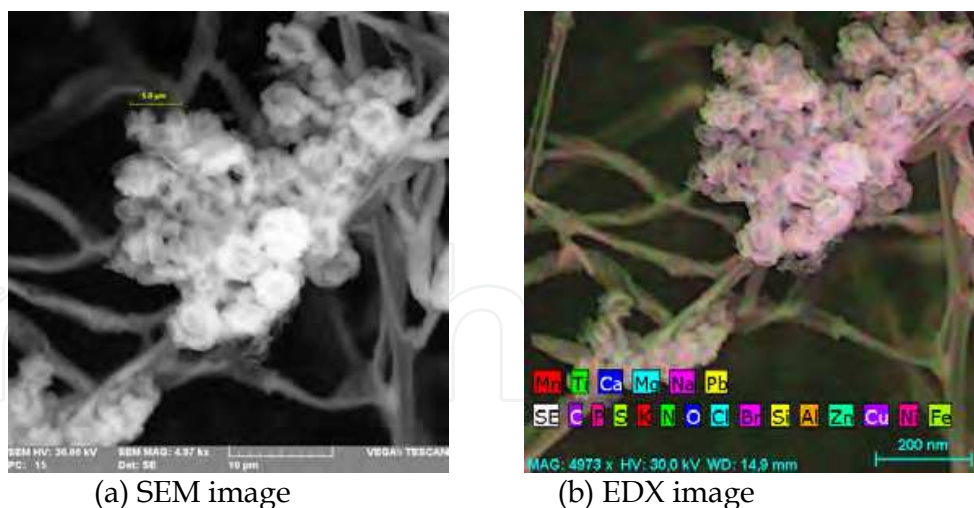

Fig. 26. Growth and develop of saprophyte microorganisms on surface of M_{OF-DP}

According to the proposed functional mechanisms and to the experimental data acquired by FTIR, the resulted functional structure of the composite derives from the functionalisation of its structural elements with BrCN, glutaraldehyde, and epichlorhydrine, respectively. FTIR acquired data reveal that the composite contains four main classes of functional groups (fig.27): amines and compounds with nitrogen, metal oxides, metal-organic and mixed functional structures. Amines and compounds with nitrogen functionalities are owed to the

functionalization processes of surface oxide components with BrCN. Most likely, in the first stage BrCN hydrolyses, leading to the formation of HCN, which attacks metal ions, anions and electric charged microsites.

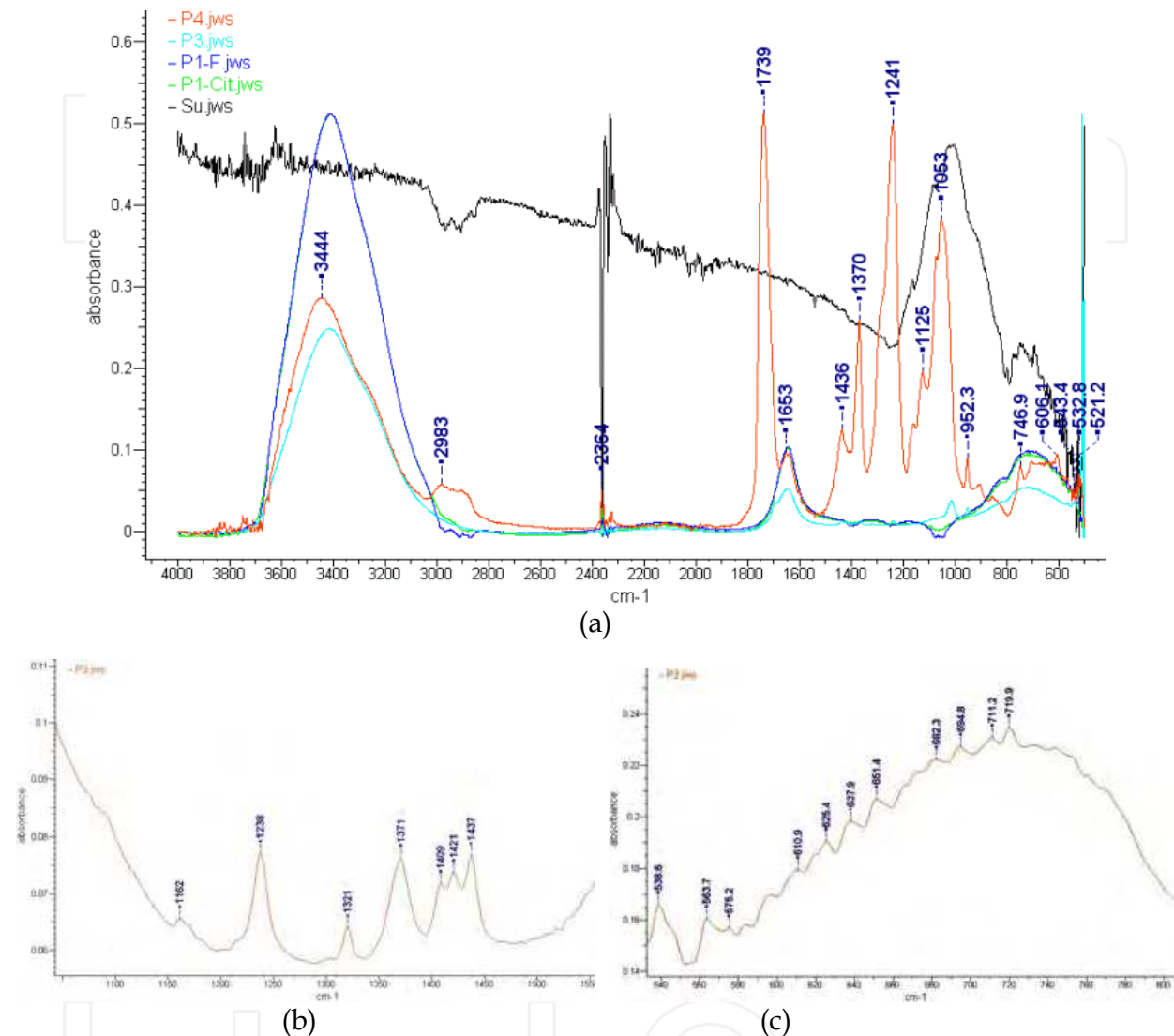

Fig. 27. IR spectra of composite and their structural components (a) IR spectra of: citrate passivated Fe_3O_4 nanoparticle (P1-Cit), $\text{Fe}_3\text{O}_4\text{-}n[\text{SiO}_{1.5\gamma}\text{-(CH}_2)_3\text{(NH}_2)]\text{(NH}_2)_{n\delta}\text{-(GL)}_{n\epsilon}$ (P1-F), functionalised cellulose (P4), Su and $\text{M}_{\text{OF-DP}}$ (P3) (b) 1000-1550 cm^{-1} IR spectra of composite (c) 500-800 cm^{-1} IR spectra of composite

The CN^- anion interaction with surface oxides leads to the formation of a wide variety of functional groups, such as: $\text{NX}_m\text{Y}_n\text{-H}$ (hydrogen bonds), $\text{N}^{+i}\text{X}_m\text{-OH}^{+n_j}$ ($i = 0, 1, j = 1\div 3, n = 0\div 2$), water-hydrogen bonds), NH_3^+ , CN , C=NH , $\text{=C-NX}_m\text{Y}_n$, NX_mY_n , $\text{C}^{m+}\text{N}^{n+}\text{X}_o$ ($n+m=5$; $\text{X, Y} = \text{H, -OH, halogens, other metallic ions}$). In return, aminated functionalities interact with metal ions in the structure of oxidic components, resulting new types of functional mixed structures, such as: $(\text{FeOFe, FBrO}_2, \text{OCIF}_4)$ (506 cm^{-1}), (Fe-O_2) (503 cm^{-1}), peroxides ($920\text{-}750 \text{ cm}^{-1}$), O=CClF (501 cm^{-1}), O=SiCl_2 (501.1 cm^{-1}), C-Cl (501.9 cm^{-1}), $(\text{ClHBr, P}_2\text{O}_6^4)$ (508 cm^{-1}), $(\text{FNCl, Al(OH)}_4^-, \text{CdO, ClNN, VF}_5)$ (720 cm^{-1}), $(\text{(OREl}_4)^-, (\text{Si}_2\text{O}_7)^6^-)$ (508 cm^{-1}), (HCN) (721 cm^{-1}), (LiNC) (722.9 cm^{-1}) (Nakamoto, 2009, 2009). Most likely, the

shape of the absorption band 950-550 cm^{-1} is due to the significant contribution of the absorbing oxide forms, of the following types: MO_4^- : $(\text{SiO}_4)^4-$ (819, 596 cm^{-1}), $(\text{PO}_4)^3-$ (938, 567 cm^{-1}), $(\text{SeO}_4)^{2-}$ (822, 856 cm^{-1}), $(\text{ClO}_4)^-$ (928 cm^{-1}), $(\text{BrO}_4)^-$ (878, 801 cm^{-1}), $(\text{TiO}_4)^4-$ (770, 761 cm^{-1}), $(\text{ZrO}_4)^4-$ (846, 792 cm^{-1}), $(\text{HfO}_4)^4-$ (800, 796 cm^{-1}), $(\text{VO}_4)^4-$ (818, 780 cm^{-1}), $(\text{VO}_4)^{3-}$ (826, 804 cm^{-1}), $(\text{CrO}_4)^{2-}$ (863, 833 cm^{-1}), $(\text{CrO}_4)^{3-}$ (844, 775.8 cm^{-1}), $(\text{MoO}_4)^{2-}$ (897, 837 cm^{-1}), $(\text{WO}_4)^{2-}$ (931, 838 cm^{-1}), $(\text{SiO}_4)^4-$ (819, 596 cm^{-1}), $(\text{MnO}_4)^{2-}$ (902, 834, 820, 821 cm^{-1}), $(\text{MnO}_4)^{3-}$ (789, 778 cm^{-1}), $(\text{TcO}_4)^-$ (921 cm^{-1}), $(\text{ReO}_4)^-$ (971, 920 cm^{-1}), $(\text{FeO}_4)^{2-}$ (832, 790 cm^{-1}), $(\text{RuO}_4)^-$ (845, 830 cm^{-1}), $(\text{RuO}_4)^{2-}$ (840, 804 cm^{-1}), OsO_4 (965.2, 960.1 cm^{-1}), $(\text{CoO}_4)^4-$ (670, 633 cm^{-1}) (Nakamoto, 2009). The absorption peaks placed at 1645, 1710, 3335 cm^{-1} , can be assigned to C = O functional groups, which are characteristic for polyurethane polymeric structures, resulted from the reticulation of -OH with aminated residues, placed on the surface of oxides. The absence of the absorption peaks of C=O, suggest that glutaraldehyde and functionalized Fe_3O_4 nanoparticle were entirely reticulated by the functionalities containing nitrogen during material composition processes. Chemical reticulation processes have favoured the compositing process, by embedment of functionalized nanoparticles of magnetite and Su on surface and in the deep structure of cellulose.

8. Conclusions

This chapter presents the main physicochemical and functional mechanisms substantiating the understanding and proper modelling of the process of obtaining composite materials with functional oriented structure. These mechanisms were substantiated on the theoretical and experimental data obtained by the team of authors and their collaborators inside applicative projects for the sensitising and detection of biochemical structure and for the separation of organic pollutants in contaminated waters.

The chapter proposes a new analytical method with invariant metrics for sensitization and biochemical monitoring, based on using magnetically stimuable functionalized nanostructures, able to prelevate a great number of biochemical analytes, undifferentiatedly and undestructively. Biochemical invariance sensitization-detection is provided by imposing analytical and practical constraints at the level of analytical acquisition and processing systems, according to the configuration of the magnetic field of the discriminator, molecular weight, specific biochemical fluorescence spectrum. We have presented the analytical structure and the elements that model the process for obtaining magnetically stimulated functionalised composites, orientated towards the detection and undestructive biological reticulation.

The second part of this chapter presents the modelling and the obtaining of new polyvalently functionalized types of materials oriented to the reticulation, encapsulation and separation of organic pollutants in contaminated waters. The obtained material has a strong, biodegradable character, being modelled morphostructurally and morphofunctionally, so as to separate by reticulation a large number of organic pollutants, toxins and microorganisms. The chapter describes the main physicochemical mechanisms that model the conditions of separation, degradation and encapsulation of pollutants.

9. Acknowledgment

The authors are grateful for the financial support granted by the CNMP (National Research, Development and Innovation Plan; Programme 4) in projects 31-001/2007, 81-002/2007 and

32-165/2008. We would also like to thank the Scientific Research Center for CBRN Defence and Ecology for the support we benefited from. Also, for their contributions to the obtaining of results, we are indebted to Dionesie Bojin, Lucia Mutihac, Viorel Ordeanu and Andrada Pretorian. For contributions to text editing and translating we are grateful to Loredana Iordache.

10. References

- Lucas, I. T.; Durand-Vidal, S.; Dubois, E.; J. Chevalet & P. Turq. (2007). Surface charge density of maghemite nanoparticles: Role of electrostatics in the proton exchange. *Journal of Physical Chemistry C*, Vol.111, No.50, pp. 18568–18576, ISSN 1932-7447
- Campos, A. F. C.; Tourinho, F. A.; T. Cotta A. P. G. & J. Depeyrot. (2002). A theoretical approach of succimer complexation at the surface of ferrite nanoparticles in order to improve the synthesis of biocompatible magnetic fluids. *European Cells and Materials*, Vol. 3, Suppl. 2, pp. 151-153, ISSN 1473-2262
- Massart, R.; Roger, J. & Cabuil, V. (June 1995). New Trends in Chemistry of Magnetic Colloids: Polar and Non Polar Magnetic Fluids, Emulsions, Capsules and Vesicles. *Brazilian Journal of Physics*, Vol. 25, No. 2, pp.135-141, ISSN 0103-9733
- Jal, P. K.; Patel, S. & Mishra, B. K. (2004). Chemical modification of silica surface by immobilization of functional groups for extractive concentration of metal ions. *Talanta*, No. 62, pp.1005-1028, ISSN 0039-9140
- Chechik, V.; Crooks, R. M. C. & Stirling, J. M. (2000). Reactions and Reactivity in Self-Assembled Monolayers, *Adv. Mater.* Vol. 12, No. 16, pp.1161-1171, ISSN 0035-9648.
- Iordache, P. Z.; Şomoghi, V.; Petrea, N.; Petre, R.; Dionezie, B.; Ordeanu, V.; Hotăranu, A. & Mutihac, L. (2009). The obtaining of nanocomposite slurries with practical application in real time biological fixing. *J. Optoelectron. Adv. M.*, Vol. 11, No. 5, pp. 736-743, ISSN 1454-4164
- Tolstoy, V. P.; Chernyshova, I. V. & Skryshevsky, V. A. (2003). *Handbook of Infrared Spectroscopy of Ultrathin Films*, Wiley & Sons, ISBN 0-471-35404-x (alk. paper), Hoboken, New Jersey
- Denmark, S. E. & Sweis R. F. (2002). Cross-Coupling Reactions of Organosilicon Compounds: New Concepts and Recent Advances, *Chem. Pharm. Bull.*, Vol. 50, No. 12, pp.1531-1541, ISSN 0009-2363
- Festag, G.; Klenz, U.; Henkel, T.; Csa'ki, A. & Fritzsche, W. (2005). *Biofunctionalization of Metallic Nanoparticles and Microarrays for Biomolecular Detection*, In: *Biofunctionalisation of Nanomaterials*, Challa S. S. R. Kumar, (Ed.), 150-182, Wiley WCH, ISBN 3-527-31381-8, Weinheim
- Murcia M. J. & Naumann C. A. (2005). *Biofunctionalization of Fluorescent Nanoparticles*, In: *Biofunctionalisation of Nanomaterials*, Challa S. S. R. Kumar, (Ed.), 1-40, Wiley WCH, ISBN 3-527-31381-8, Weinheim
- Bekyarova, E.; Haddon, R. C. & Parpura V. (2005). *Biofunctionalization of Carbon Nanotubes*, In: *Biofunctionalisation of Nanomaterials*, Challa S. S. R. Kumar, (Ed.), 41-71, Wiley WCH, ISBN 3-527-31381-8, Weinheim
- Gao, Y. (2005). *Biofunctionalization of Magnetic Nanoparticles*, In: *Biofunctionalisation of Nanomaterials*, Challa S. S. R. Kumar, (Ed.), 72-98, Wiley WCH, ISBN 3-527-31381-8, Weinheim

- Zheng, M & Huang, X. (2005). *Biofunctionalization of Gold Nanoparticles*, In: *Biofunctionalisation of Nanomaterials*, Challa S. S. R. Kumar, (Ed.), 99-124, Wiley WCH, ISBN 3-527-31381-8, Weinheim
- Watanabe, J; Park, J.; Ito, T.; Takai M. & Ishihara K. (2005). *Biofunctionalization of Phospholipid Polymer Nanoparticles*, In: *Biofunctionalisation of Nanomaterials*, Challa S. S. R. Kumar, (Ed.), 125-149, Wiley WCH, ISBN 3-527-31381-8, Weinheim
- Meziani, M. J.; Lin, Y. & Sun, Y. P. (2005). *Conjugation of Nanomaterials with Proteins*, In: *Biofunctionalisation of Nanomaterials*, Challa S. S. R. Kumar, (Ed.), 183-234, Wiley WCH, ISBN 3-527-31381-8, Weinheim
- Le'vy R. & Doty R. C. (2005). *Stabilization and Functionalization of Metallic Nanoparticles: the Peptide*, In: *Biofunctionalisation of Nanomaterials*, Challa S. S. R. Kumar, (Ed.), 235-269, Wiley WCH, ISBN 3-527-31381-8, Weinheim
- Hattori Y. & Maitani, Y. (2005). *Folate-linked Lipid-based Nanoparticles for Tumor-targeted Gene Therapy: the Peptide*, In: *Biofunctionalisation of Nanomaterials*, Challa S. S. R. Kumar, (Ed.), 270-298, Wiley WCH, ISBN 3-527-31381-8, Weinheim
- Lellouche, J. P. (2005). *Magnetic Core Conducting Polymer Shell Nanocomposites for DNA Attachment and Hybridization*, In: *Biofunctionalisation of Nanomaterials*, Challa S. S. R. Kumar, (Ed.), 299-329, Wiley WCH, ISBN 3-527-31381-8, Weinheim
- Kommareddy, S.; Shenoy, D. B. & Amiji, M. M. (2005). *Gelatin Nanoparticles and Their Biofunctionalization*, In: *Biofunctionalisation of Nanomaterials*, Challa S. S. R. Kumar, (Ed.), 330-352, Wiley WCH, ISBN 3-527-31381-8, Weinheim
- Bhunia, A. K. (2008). Biosensors and Bio-Based Methods for the Separation and Detection of Foodborne Pathogens. *Advances in Food and Nutrition Research*, Vol.54, pp. 1-44, ISSN 1043-4526
- Jasson, V.; Jacxsens, L.; Luning, P.; Rajkovic, A. & Uyttendaele M. (2010). Alternative microbial methods: An overview and selection criteria. *Food Microbiology*, No.27, pp. 710-730, ISSN 0740-0020
- Iordache, P. Z.; Şomoghi, V.; Savu, I.; Petrea, N.; Mitru, G.; Petre, R.; Dionezie, B.; Ordeanu, V.; Hotăranu, A. & Mutihac, L. (2009). Biochemical Fixing and Activation Mechanisms of Amino Groups Deposited on the Surface and in the Depth of Polymeric Layers of the $n[\text{SiO}_{1.5}-(\text{CH}_2)_3\text{NH}_2]$ Type Deposited on the Fe_3O_4 Nanoparticle Surface. *Revista de chimie - Materiale Plastice*, Vol. 46, No. 2, pp. 162-168, ISSN 0034-7744
- Petrea, N.; Iordache, P. Z.; Şomoghi, V.; Savu, I.; Mureşan, M.; Petre, R.; Rece, L.; Lungu, R.; Pretorian, A.; Mitru, G.; Dionezie, B.; Savu, B.; Mutihac, L.; Kim, L. & Ordeanu, V. (2009). The Obtaining of High Sensitivity and Specificity Transducer Media for Sensors Specialized in Biological Toxin Detection, *Digest Journal of Nanomaterials and Biostructures*, Vol. 4, No. 4, pp.699-712, ISSN 1842-3582
- Iordache, P. Z.; Lungu, R. M.; Epure, G.; Mureşan, M.; Petre, R.; Petrea, N.; Pretorian, A.; Dionezie, B.; Mutihac, L. & Ordeanu, V. (2011). The determination of the nanostructured materials' morphology, by applying the statistics of the structural element maps, *Journal of Optoelectronics and Advanced Materials*, Vol. 13, No. 5, pp. 550-559, ISSN 1454-4164
- Gogate, P.R.; Pandit AB.; (2004). A review of imperative technologies for wastewater treatment I: oxidation technologies at ambient conditions, *Advances in Environmental Research*, Vol. 8, No. 3-4, pp. 501-551, ISSN 1093-0191

- Cheremisinoff, N.P. (2002). *Handbook of water and wastewater treatment technologies*, Butterworth-Heinemann, ISBN 0-7506-7498-9, Boston
- Robinson, T.; McMullan, G.; Marchant, R. & Nigam, P. (2001). Remediation of dyes in textile effluent: a critical review on current treatment technologies with a proposed alternative, *Bioresource Technology*, Vol. 77, No. 3, pp. 247-255, ISSN 0960-8524
- Tedder, D.W. & Pohland, F.G. (1990). *Emerging Technologies in Hazardous Waste Management*, ACS Symposium Series, ISBN 0-8412-1747-5, Washington, DC
- Hashimoto, K.; Irie, H. & Fujishima A. (2005). TiO₂ Photocatalysis: A Historical Overview and Future Prospects, *Japanese Journal of Applied Physics*, Vol. 44, No. 12, pp. 8269-8285, ISSN 0021-4922
- Cassano, A.; Molinari, R.; Romano, M. & Drioli, E. (2001). Treatment of aqueous effluents of the leather industry by membrane processes: A review, *Journal of Membrane Science*, Vol. 181, No. 1, pp. 111-126, ISSN 0376-7388
- Evangelou, V., P. (1998). *Environmental soil and water chemistry - Principles and applications*, John Wiley & Sons, ISBN 0-471-16515-8, Hoboken, New York
- Nakamoto, K. (2009). *Infrared and Raman Spectra of Inorganic and Coordination Compounds - Part A: Theory and Applications in Inorganic Chemistry*, 5rd ed., Wiley, ISBN 978-0-471-74339-2, Hoboken, New Jersey
- Nakamoto, K. (2009). *Infrared and Raman Spectra of Inorganic and Coordination Compounds - Part B: Applications in Coordination, Organometallic, and Bioinorganic Chemistry*, 5rd ed., Wiley, ISBN 978-0-471-74493-1, Hoboken, New Jersey

IntechOpen

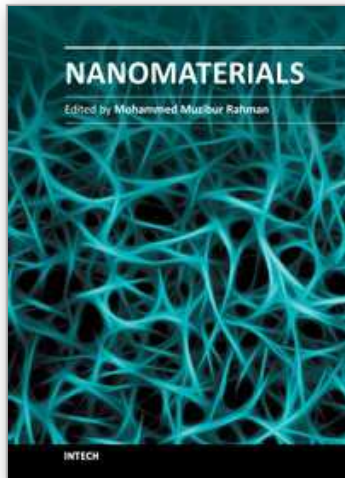

Nanomaterials

Edited by Prof. Mohammed Rahman

ISBN 978-953-307-913-4

Hard cover, 346 pages

Publisher InTech

Published online 22, December, 2011

Published in print edition December, 2011

The book "Nanomaterials" includes all aspects of metal-oxide nano-structures, nano-composites, and polymer materials instigating with materials survey and preparations, growth and characterizations, processing and fabrications, developments and potential applications. These topics have utilized innovative methods of preparation, improvement, and continuous changes in multidimensional ways. The innovative frontiers are branching out from time to time to advanced nanotechnology. It is an important booklet for scientific organizations, governmental research-centers, academic libraries, and the overall research and development of nano-materials in general. It has been created for widespread audience with diverse backgrounds and education.

How to reference

In order to correctly reference this scholarly work, feel free to copy and paste the following:

Petrişor Zamora Iordache, Nicoleta Petrea, Rodica Mihaela Lungu, Răzvan Petre, Ciprian Său and Ioan Safta (2011). Nanocomposite Materials with Oriented Functionalized Structure, *Nanomaterials*, Prof. Mohammed Rahman (Ed.), ISBN: 978-953-307-913-4, InTech, Available from:

<http://www.intechopen.com/books/nanomaterials/nanocomposite-materials-with-oriented-functionalized-structure>

INTECH
open science | open minds

InTech Europe

University Campus STeP Ri
Slavka Krautzeka 83/A
51000 Rijeka, Croatia
Phone: +385 (51) 770 447
Fax: +385 (51) 686 166
www.intechopen.com

InTech China

Unit 405, Office Block, Hotel Equatorial Shanghai
No.65, Yan An Road (West), Shanghai, 200040, China
中国上海市延安西路65号上海国际贵都大饭店办公楼405单元
Phone: +86-21-62489820
Fax: +86-21-62489821

© 2011 The Author(s). Licensee IntechOpen. This is an open access article distributed under the terms of the [Creative Commons Attribution 3.0 License](#), which permits unrestricted use, distribution, and reproduction in any medium, provided the original work is properly cited.

IntechOpen

IntechOpen