

We are IntechOpen, the world's leading publisher of Open Access books Built by scientists, for scientists

4,800

Open access books available

122,000

International authors and editors

135M

Downloads

Our authors are among the

154

Countries delivered to

TOP 1%

most cited scientists

12.2%

Contributors from top 500 universities



WEB OF SCIENCE™

Selection of our books indexed in the Book Citation Index
in Web of Science™ Core Collection (BKCI)

Interested in publishing with us?
Contact book.department@intechopen.com

Numbers displayed above are based on latest data collected.
For more information visit www.intechopen.com



Surface and Bulk Modification of Synthetic Textiles to Improve Dyeability

Mazeyar Parvinzadeh Gashti¹, Julie Willoughby² and Pramod Agrawal^{3,4}

¹*Department of Chemistry and Biochemistry, University of Bern, Bern*

²*Fiber and Polymer Science Program, Department of Textiles Engineering, Chemistry and Science, North Carolina State University, Raleigh NC,*

³*Engineering of Fibrous Smart Materials,*

Department of Engineering Technology, University of Twente, Enschede,

⁴*Knowledge Centre Design & Technology, School of Applied Art & Technology, Saxion University of Applied Sciences, Enschede,*

¹*Switzerland*

²*USA*

^{3,4}*The Netherlands*

1. Introduction

Synthetic fibers, mainly polyethylene terephthalate (PET), polyamide (PA), polyacrylonitrile (PAN) and polypropylene (PP), are the most widely used polymers in the textile industry. These fibers surpass the production of natural fibers with a market share of 54.4%. The advantages of these fibers are their high modulus and strength, stiffness, stretch or elasticity, wrinkle and abrasion resistances, relatively low cost, convenient processing, tailorable performance and easy recycling. The downside to synthetic fibers use are reduced wearing comfort, build-up of electrostatic charge, the tendency to pill, difficulties in finishing, poor soil release properties and low dyeability. These disadvantages are largely associated with their hydrophobic nature. To render their surfaces hydrophilic, various physical, chemical and bulk modification methods are employed to mimic the advantageous properties of their natural counterparts. This review is focused on the application of recent methods for the modification of synthetic textiles using physical methods (corona discharge, plasma, laser, electron beam and neutron irradiations), chemical methods (ozone-gas treatment, supercritical carbon dioxide technique, vapor deposition, surface grafting, enzymatic modification, sol-gel technique, layer-by-layer deposition of nano-materials, micro-encapsulation method and treatment with different reagents) and bulk modification methods by blending polymers with different compounds in extrusion to absorb different colorants.

Nowadays, the bulk and surface functionalization of synthetic fibers for various applications is considered as one of the best methods for modern textile finishing processes (Tomasino, 1992). This last stage of textile processing has employed new routes to demonstrate the great potential of nano-science and technology for this industry (Lewin, 2007). Combination of physical technologies and nano-science enhances the durability of textile materials against washing, ultraviolet radiation, friction, abrasion, tension and fading (Kirk-Othmer, 1998). European methods for application of new functional finishing

materials must meet high ethical demands for environmental-friendly processing (Fourne, 1999). For this purpose the process of textile finishing is optimized by different researchers in new findings (Elices & Llorca, 2002). Application of inorganic and organic nano-particles have enhanced synthetic fibers attributes, such as softness, durability, breathability, water repellency, fire retardancy and antimicrobial properties (Franz, 2003; McIntyre, 2005; Xanthos, 2005). This review article gives an application overview of various physical and chemical methods of inorganic and organic structured material as potential modifying agents of textiles with emphasis on dyeability enhancements.

The composition of synthetic fibers includes polypropylene (PP), polyethylene terephthalate (PET), polyamides (PA) or polyacrylonitrile (PAN). Synthetic fibers already hold a 54% market share in the fiber market. Of this market share, PET alone accounts for almost 50% of all fiber materials in 2008 (Gubitz & Cavaco-Paulo, 2008). Polypropylene, a major component for the nonwovens market accounts for 10% of the market share of both natural and synthetic fibers worldwide (INDA, 2008 and Aizenshtein, 2008). It is apparent that synthetic polymers have unique properties, such as high uniformity, mechanical strength and resistance to chemicals or abrasion. However, high hydrophobicity, the build-up of static charges, poor breathability, and resistant to finishing are undesirable properties of synthetic materials (Gubitz & Cavaco-Paulo, 2008).

Synthetic textile fibers typically undergo a variety of pre-treatments before dyeing and printing is feasible. Compared to their cotton counterparts, fabrics made from synthetic fibers undergo mild scouring before dyeing. Nonetheless, these treatments still create undesirable process conditions which can result in increased waste production, unpleasant working conditions and higher energy consumption. Therefore reducing pollution in textile production is becoming of utmost importance for manufacturers worldwide. In coming years, the textile industry must implement sustainable technologies and develop environmentally safer methods for textiles processing to remain competitive (Agrawal et. al., 2008).

1.1 Fiber-forming synthetic polymers

Fibers comprising at least 85% by weight of a substituted aromatic (or aliphatic) carboxylic acid ester are termed polyesters. The most important representative of this category is polyethylene terephthalate or PET (BISFA, 2009). PET is a hydrophobic fiber with maximum moisture regain of only 1% at 100% relative humidity. Until the development of disperse dyes, dyeing of polyester was difficult. Disperse dyes with very low water solubility can sublime into PET fibers by heat through Thermosol and/or thermofixation processes. It can be applied with heat, pressure or via carriers by an exhaust process (Cavaco-Paulo & Gubitz, 2003). Alkali treatment can be used to etch the PET surface to increase the hydrophilicity of the fiber resulting in better dyeability. However, the rate of hydrolysis is very low without a catalyst and surface-limited (BISFA, 2009).

In generic terms, aliphatic polyamides (PA) are called nylons and aromatic PAs are called aramids. The first important PA was Nylon 66 as produced by the reaction of adipic acid and hexamethylene diamine monomer (Cavaco-Paulo & Gubitz, 2003). Several structural modifications with differing temperature capabilities have become commercially available, including Nylon 46, 610, 612, 6, 11, and so on. Polyamides have applications in many areas, the most important being in the production of fiber-based materials (BISFA, 2009). Nylons are dyeable with disperse dyes or with acid dyes under mild acidic conditions. Aqueous acids (below pH 3) as well as bases cause the rupture of the polymer backbone. In the case of acid dyeing, dye molecules only attach to available amino end groups, thus shade depth is

determined by the ratio of negatively charged groups of the dye molecule to positively charged end groups in the fiber.

2. Classification of methods used for synthetic textiles modification

Synthetic fibers have relatively high levels of orientation and crystallinity that impart the desired properties. These same characteristics contribute to their structural resistance to coloration by dye compounds and finishing with various materials necessitating enhancement of the fiber surface for improved dye receptivity. In this sense, a large body exists to improve fiber dyeability via physical methods (corona discharge, plasma, laser, electron beam and neutron irradiation functionalizations), chemical methods (enzymatic modification grafting of different monomers, utilization of supercritical carbon dioxide as the solvent carrier for disperse dyes, sol-gel technique, layer-by-layer deposition and treatment with different reagents) and bulk modification methods using various additives during fiber processing. In last decade, traditional methods that consume high amounts of energy and water are under pressure for replacement due to high manufacturing costs and negative environmental impact. In addition, some processing negates the bulk properties of fibers, require harsh process conditions, and produce undesirable side effects and/or waste disposal problems. Recent methods address these challenges and deficiencies of traditional techniques and will be discussed in this chapter (Textor et al., 2003).

2.1 Physical methods

Traditional transformation of a hydrophobic polymer such as poly(dimethylsiloxane) (PDMS) to a hydrophilic state has been achieved via techniques such as corona and plasma treatments (Ferguson et al., 1993; Owen, 2005). Corona, plasma, irradiation, and laser technologies are ideal for textile surface modifications due to the energy-efficient dry-state processing, continuous on-line applicability, and minimal precursor quantity requirements. In addition, surface modification does not ingress to the bulk fiber's mechanical properties although physical alterations are generally realized on the fiber's outermost surface layer. Depending on the treatment duration, the changes can propagate several microns below the surface. X-ray photoelectron spectroscopy (XPS) analysis on oxygen plasma treated samples demonstrated a rapid substitution of carbon atoms by oxygen atoms, which led to the formation of hydrophilic surfaces (Hillborg & et al., 2000). This treatment will propagate several hundred nanometers below the surface with irreversible chemical changes at the near-surface region (Hillborg & Gedde UW, 1999; Hillborg & et al., 2000; Owen & Smith, 1994). The various physical methods all have their merits with some processes, such as corona, more applicable to simple on-line installation. This section will highlight each technique with some examples on their resultant properties.

2.1.1 Corona discharge

Corona discharge is the breakdown of a gas between two electrodes. When the gas is anything but air, it is termed plasma modification to be discussed in the next section. The generation of the initial hydrophilic surface is the same in both modifications with just different outcomes based on the introduced gas stream. **Figure 1** (Borcia, 2006) depicts a typical schematic for dielectric discharge modification. When the high voltage or electric field is applied in a gas layer exposed to a polymer surface, the gas molecules, in this case air, breakdown to ions to conduct electricity. It is the bluish air glow from the electric source that is termed corona. This

phenomenon starts with a few stray electrons colliding with other gas molecules. The collision rapidly generates several multiple electrons, positive ions, and excited molecules. The unstable excited molecules decompose to radicals, ions and photons, i.e. reactive species. When the gas is oxygen (or air), the reactive species are elemental oxygen (O^{\bullet}), ozone (O_3) and activated oxygen (O_2^*). **Scheme 1** shows the general reactions of polyethylene terephthalate (PET) in the presence of either UV or corona as the mechanisms are believed to be the same. The terminal phenols and hydroxy phenolics are rapidly formed on the surface of corona-exposed PET between the reactive oxygen species and moisture in the air (Owens, 1975; Valk, Kehren, & Daamen, 1970; Zhang, Sun, & Wadsworth, 1998). Other polar moieties that are formed during corona treatment include carbonyls ($-CO$) and carboxyls ($-COO$). This change in surface polarity has been widely studied for increases in adhesion, wettability, printing, and as the subject of this chapter, dyeing. Several excellent reviews are referenced here that detail the specific and mechanisms of the treatment (Nitschke, 2008; Podhajny, 1987; Zhang, Sun, & Wadsworth, 1998).

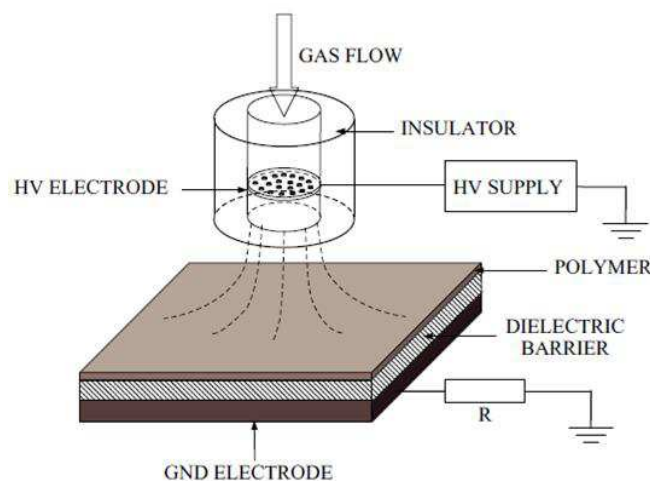
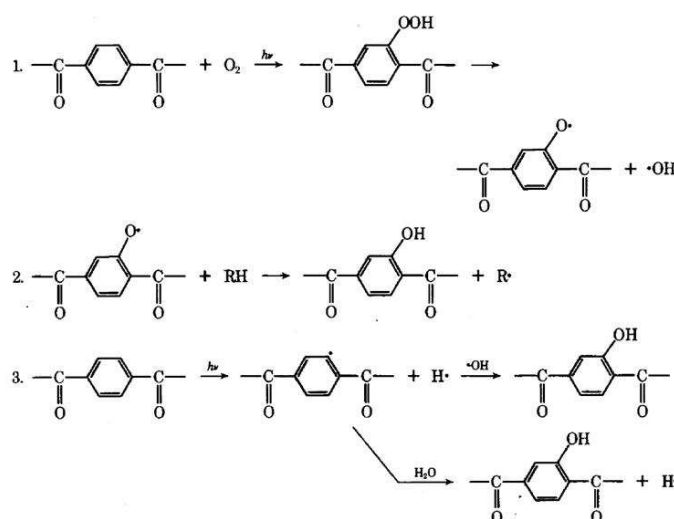

Fig. 1. Typical setup for corona discharge modification to a polymeric surface (Borcia, 2006).



Scheme 1. Phenolic hydroxy groups in PET after exposure to physical treatment such as corona or oxygen plasma (Owens, 1975).

A recent study evaluated not just how corona discharge affects conversion to hydrophilicity in terms of enhanced dyeability of synthetic fibers but also in how the fiber topography changes as a result of physical treatment ultimately influencing dyeability as well (Brzezinski et al., 2010). The study postulated that without fully understanding topography, specifically fiber roughness, correlating the varying results of the many conflicting studies of fiber dyeing with respect to corona treatment is too convoluted. To this extent, three synthetic fibers in separate woven mats were evaluated 1) polyester (PET), 2) polyamide (PA6) and 3) polypropylene (PP). The corona generator was unique in that its construction afforded a high degree and uniform surface modification to the fibers. This was by designing a multi-segmented electrode system where continuous low energy doses equated the larger required total energy dose for adequate surface modification. The process conditions previously determined for each fiber resulted in total activation energies E_j of 75.6 J/cm² for PET, E_j of 18.9 J/cm² for PA6, and E_j of 22.7 J/cm² for PP fabrics. **Figure 2** depicts the difference via atomic force microscopy (AFM) before and after modification for the PP fabric sample where clear disruption of the fiber surface is apparent. In addition to increased roughness, the change in free surface energy was approximately 10, 4, and 30 J/cm² for PET, PA6, and PP respectively. Dyeability for the modified samples was assessed with two techniques; 1) exhaustion and 2) the preferred Thermosol continuous method. The results between unmodified and modified samples showed little difference in the dyeing attributes via the exhaustion methods, as measured by degree of dye exhaustion, ΔE or color difference, and dyeing fastness. This was attributed to the fact that corona discharge does not modify the entire fiber depth but rather only the first 200nm from the surface of the approximately 6500nm diameter fiber. Therefore in the dyeing techniques, such as exhaustion, where the entire fabric is immersed into the bath batch-wise, the dye pick-up rate is minimal. In contrast, dyeing methods that are applied only to the surface of the fiber, as in the case with the Thermosol method, surface hydrophilicity and roughness are far greater parameters to gauge the receptivity of the dye. In this case, the dye intensity for the corona-modified samples was significantly enhanced as measured by the color difference ΔE for the two dyes studied, C.I. Disperse Blue 73 and C.I. Disperse Red 54 (Brzezinski et al., 2010).

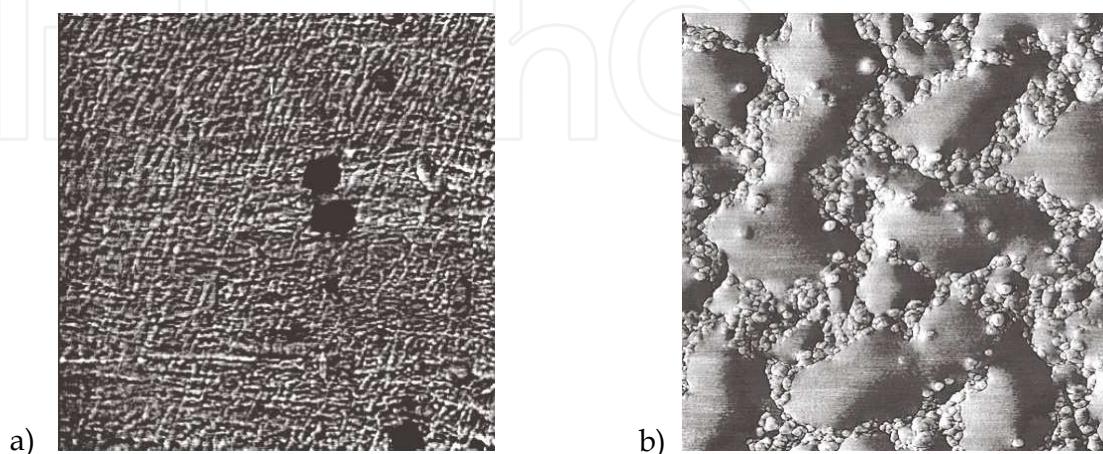

Fig. 2. AFM images of polypropylene woven fabric a) before and b) after corona discharge treatment (Brzezinski, Kaleta, Kowalczyk, Malinowska, & Gajdzicki, 2010).

2.1.2 Plasma functionalization

As mentioned, when the dielectric discharge occurs in environments besides air, the technology is referred to as plasma treatment; it has been studied at both vacuum and atmospheric pressures. The various gases employed include oxygen, nitrogen, argon, ammonia and reactive monomers. The hydrophilicity of poly(ethylene terephthalate) (PET) was greatly improved with the plasma method where the discharge barrier occurred in argon, nitrogen and air (Hsieh & Chen, 1985). The surface wettability enhancements were due to two reactions; 1) direct reaction (i.e. oxidation) of reactive gases (oxygen plasma) and 2) free radical formation and their subsequent reactions such as degradation and crosslinking (Hsieh & Chen, 1985). In this study, it was determined that a nitrogen atmosphere with a glow discharge of 30W provided the most durable and wettable surface finish for PET. The optimum power level of 30W was chosen from experiments in air at power levels ranging from 10-30W. **Figure 3** illustrates the differences of wettability at the optimum power level.

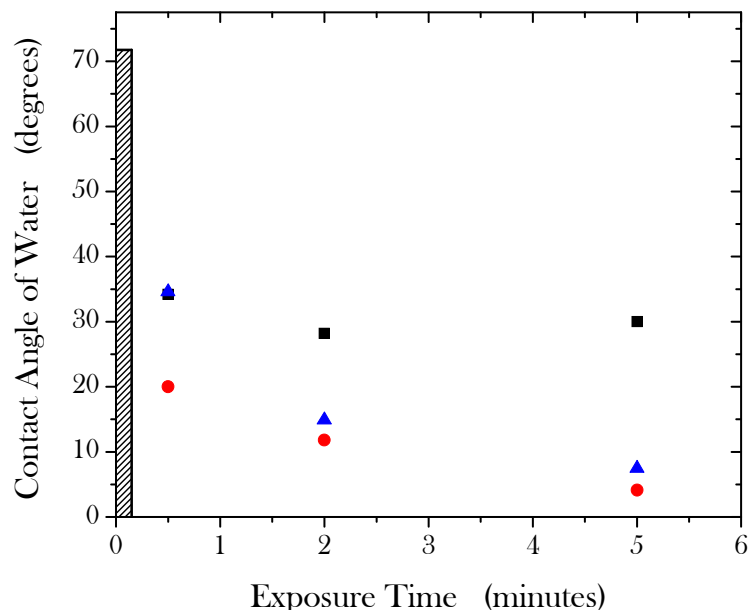

Fig. 3. Advancing water contact angles for PET modified as a function of plasma exposure time in air (■), argon (▲), and nitrogen (●). The bar at time zero is the contact angle for virgin PET. Replotted from data in (Hsieh & Chen, 1985).

Plasma treatment has also been performed on PET fiber prior to coating with a PDMS surfactant. In this case the efficacy of the surfactant was greatly enhanced with plasma activation at 1kW, 10 kHz, in the presence of air. It was determined by scanning electron microscopy that the plasma treated fibers were rougher allowing increased PDMS deposition via observation of a smoother coating, less moisture regain after coating with PDMS which is hydrophobic in nature, better drape recovery and more wrinkle resistance (Parvinzadeh & Ebrahimi, 2011).

2.1.3 Laser treatment

Laser induced surface modification of polymers provides a unique and powerful method for the surface modification without any changes in their bulk properties. The smooth surface of

synthetic fibers can be modified by this technique to a regular, roll-like structure, which has a striking effect on adhesion of particles and coatings, wetting properties and optical appearance (Knittel & Schollmeyer, 1998; Watanabe & Takata, 1996; Ondogan et al., 2005; Shaohua et al., 2003).

Yip et al. applied a 193 nm argon fluoride excimer laser on polyamide (nylon 6) fabrics. Micrometer-sized ripple like structures were developed on the surface of irradiated fabric and chemical analysis indicates that carbonization has occurred. It is believed that the laser treatment breaks the long chain molecules of nylon, thus increasing the number of amine end-groups (Yip et al., 2002).

Kan stated that properties such as wettability and air permeability of polyester were positively affected by laser while fiber weight and diameter, tensile strength, yarn abrasion and bending were adversely affected (.cf **Figure 4**). In this study, laser irradiation was not found to affect the bulk properties of polymer due to its low penetration depth (Kan, 2008a; 2008b).

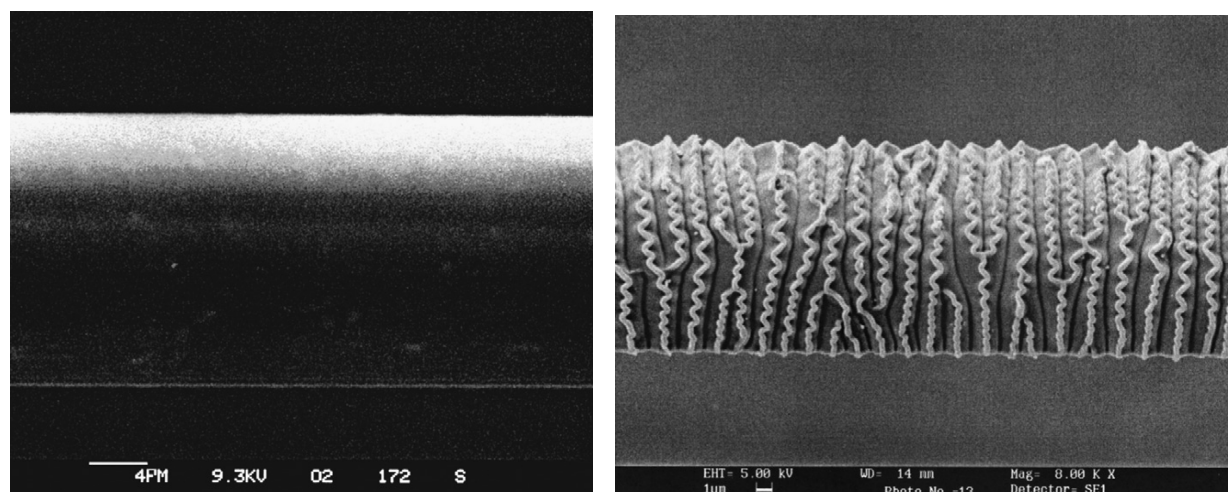

Fig. 4. Surface structure of polyester fiber before and after laser treatment (Kan, 2008a)

2.1.4 Other physical methods

Exposing fibers to a stream of high-energy electrons is another method for surface modification. The dyeability of hydrophobic polypropylene fibers was enhanced by Kim and Bae using electron beam irradiation and sulfonic acid incorporation. The color strength of polypropylene fibers after irradiation was examined according to the dyeing conditions including the pH of the dye bath, absorbed doses, and the introduction of a functional group to the fiber substrate. The best dyeing result was obtained with cationic dyes at alkaline conditions (Kim & Bae, 2009; Alberti et al. 2005).

Neutron irradiation significantly changes the material properties by displacement of lattice atoms and the generation of helium and hydrogen by nuclear transmutation. Mallick et al. considered the shift in some of the Raman peak positions to a higher value with the development of micro-stresses due to neutron irradiation of synthetic fibers. The defects due to irradiation were confirmed by SEM micrographs of virgin and irradiated fibers (Mallick et al., 2005).

Critical temperature and pressure describes a fluid at temperatures and pressures higher than those at which the liquid and gaseous states of the given substance would have the same density. Prorokova et al. showed modification of the surface of PET fabrics by application of a water-repellent coating in supercritical carbon dioxide medium. It was believed that in treating PET fiber materials with a solution of low-molecular-weight poly(tetrafluoroethylene) in supercritical carbon dioxide, an ultrathin layer of fluoropolymer is formed on the surface. This layer gives the fabric a high degree of water repellency (Prorokova et al., 2009).

Another potentially attractive approach would take advantage of UV light's ability to transform chemistry of the polymer surface. Zhu and Kelley modified the surface of PET by deep UV (172 nm) irradiation. The main effects were increased conversion of the C=O moiety to carboxylic acid with negligible change to fiber topography. Other studies revealed that surface chemical composition, morphology, adhesion, thermomechanics, and stiffness/modulus of PET are strongly influenced by UV irradiation in the presence of bi-functional media (Zhua & Kelley, 2004; Gao et al., 2005).

2.2 Chemical methods

The methods discussed in the following sections include ozonolysis, supercritical carbon dioxide, chemical vapor deposition, "grafting to", enzymatic modification, sol-gel deposition, layer-by-layer, micro-surface modification by alkaline or acidic means, and macro-encapsulation of dye molecules. In many instances, the best performance is obtained from a combination of physical and chemical methods, especially for poly(propylene).

2.2.1 Ozone gas treatment

Hydrophilicity of synthetic polymer surfaces can be achieved with functionalization of peroxide molecules via exposure to ozone (O_3). An advantage of ozone treatment is the uniform coverage of the reactive molecules on 3-D structures. It is also well-known that ozone will treat not only the surface but diffuse through the polymer bulk (Fujimoto et al., 1993; Ko et al., 2001; Kulik, Ivanchenko, Kato, Sano, & Ikada, 1995). The process is often done in the gas phase but aqueous treatment has also been employed with good results (Gu, Wu, & Doan, 2009). In an early study by Fujimoto et al., the surface oxidation of polyurethane (PU) and polyethylene (PE) films were evaluated by both ozone and plasma treatment (Fujimoto et al., 1993). The process conditions for ozone treatment followed typical gas reactor set-up as illustrated in **Figure 5**. Of the process variables to control, gas mass flow rate, voltage and time are the most common to control ozone concentration. The formed polymeric peroxides on the surface and in the bulk were quantified by iodide (Frew, Jones, & Scholes, 1983), DPPH (Frew et al., 1983), and peroxidase spectrophotometric methods (Suzuki, Kishida, Iwata, & Ikada, 1986). Additional surface analysis to confirm reactivity of the ozone included wettability measurements, Fourier infrared spectroscopy in the attenuated reflectance mode (FTIR-ATR), and X-Ray Photoelectro Spectroscopy (XPS/ ESCA). Subsequent to oxidation was the graft polymerization of acrylamide which will be discussed in Section 2.2.4. The surface oxidation efficiency was evaluated based on water contact angle (*cf.* **Figure 6**) and peroxide concentration. Of interest is that the wettability of the plasma exposed films is much higher than the ozonated films but the peroxide concentration in the plasma treated polyurethane film (Power = 24W, exposure time = 20 seconds) is lower than its ozone counterpart (Voltage =100V, exposure

time =20 minutes, O_2 flow = 50 L· hr⁻¹). It should also be noted the concentration of peroxide decreases with polymer rigidity and nonpolar constituents (C-F).

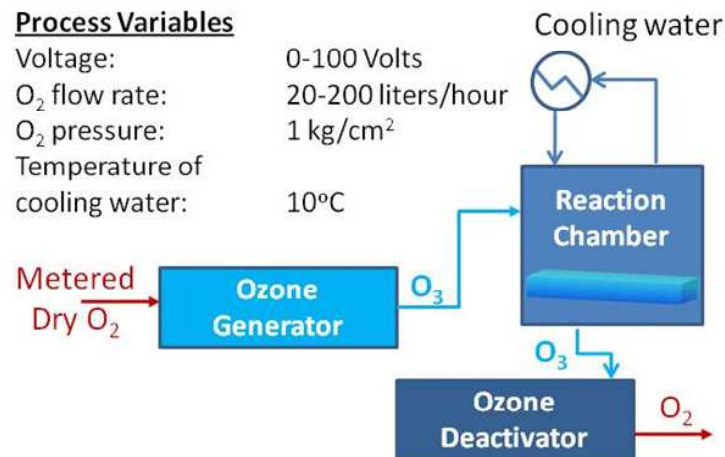

Fig. 5. Typical set-up for ozonolysis of substrates. Redrawn from (Fujimoto, Takebayashi, Inoue, & Ikada, 1993)

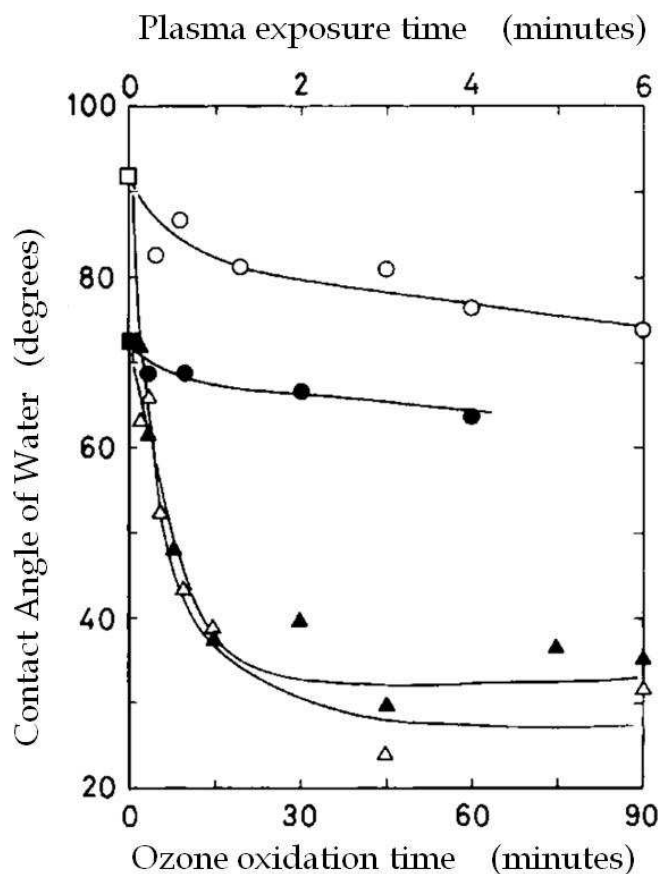

Fig. 6. Decrease in contact angle of PE and PU films by ozone oxidation and plasma exposure. Ozone (60V, 50 Lhr⁻¹): (○) PE, (●) PU. Plasma (Ar, 24 W): (△) PE, (▲) PU. Virgin: (□) PE, (■) PU. From (Fujimoto et al., 1993).

Ozone self-decomposes rapidly in water producing free radicals, a stronger oxidant than ozone itself (Hoigne & Bader, 1976). This property was utilized to produce hydrophilic and highly reactive high-density polyethylene (HDPE) films (Gu et al., 2009). The O_2 gas rate in this study was about twelve times higher with exit ozone concentrations ranging between 1-3.7 weight percent.

Figure 7 illustrates the difference of ozone treatment in the aqueous phase versus the gas phase. While initially there is no apparent difference in the media treatment, the peroxide generation (as measured by the iodometric method (Kokatnur & Jelling, 1941)) is greater and faster for ozonation in the aqueous phase. For all samples, it was demonstrated that the stability of the generated peroxides lasted at least 15 days with no change in concentration. The subsequent grafting of acrylamide on the aqueous ozone treated samples was successful but its performance in terms of surface energy was not contrasted to acrylamide graft polymerization on gas-phase ozone treated samples.

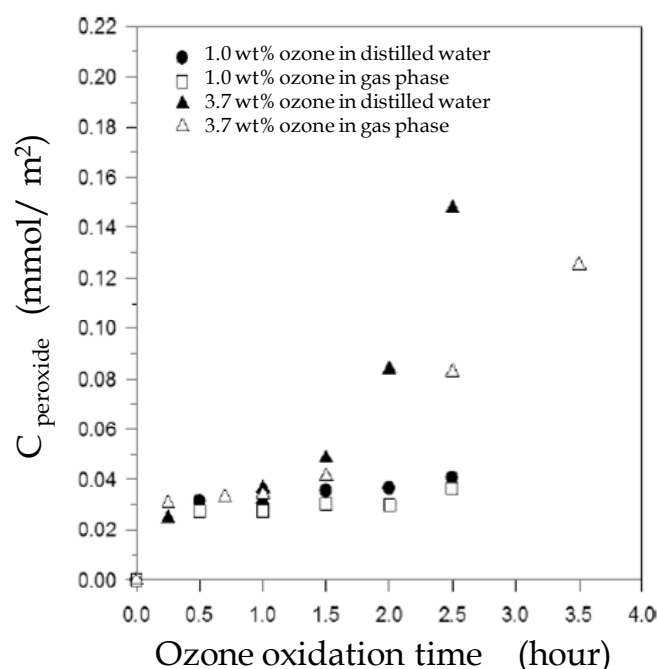

Fig. 7. Peroxides generated after different ozonation times in different media (Gu et al., 2009)

Specific to fabrics, chemical modification via gas-phase ozone treatment was performed on nylon 6 taffeta, polyester taffetas (Lee et al., 2006), cationic dyeable polyester (CDP) and poly(butylene terephthalate) fibers (Lee et al., 2006, 2007). The surface analysis via ESCA was very comparable to the plasma studies by others (Fujimoto et al., 1993), the reader is referred to previous methods for process conditions (Wakida et al., 2004). Notable is that the processing time was only 10 minutes with similar surface chemistries for operations at atmospheric pressure and 0.1 MPa. The ozone-modified fabrics were treated with Disperse Red 60 and Disperse Blue 56 dyes in batch immersion at 100°C for up to 120 hours. The authors found that the internal structure of the fibers increased in crystallinity (as measured by a density gradient column and X-ray diffraction), wettability and moisture uptake upon ozone treatment. These characteristics of the modified fibers were attributed to the increase in dye uptake rate, especially for polyester fibers. The equilibrium dye uptake increased for PBT fibers, polyester taffeta and nylon 6 taffeta but remained unchanged for CDP fibers.

2.2.2 Supercritical carbon dioxide technique

In recent years, waterless dyeing in supercritical carbon dioxide (scCO₂) fluid has been gaining much interest to textile chemists. This process is deemed an environmentally safe solvent as opposed to the traditional solvent of choice, water. Application of these techniques can result in reducing waste and cost for the entire dyeing process of synthetic textiles (Kikic & Vecchione, 2003).

The possible advantages of this process are

1. Plasticizing effect due to CO₂ on textiles decreasing the glass transition temperature.
2. Elimination of contaminated waste water streams.
3. Elimination of chemicals, such as leveling agents, pH regulations and dispersants, to solubilize disperse dyes in medium.
4. Controllable solubilities of disperse dyes via pressure.
5. Diffusion of dyes and penetration of voids within the fiber structure in the fluid is higher/ faster due to zero surface tension between air and scCO₂ carbon dioxide.
6. Generation of effluents due to dyeing or recycling of contaminated gas streams does not exist.
7. Energy consumption is low for heating up dyeing liquor.
8. For polyester, elimination of reduction clearing process, short dyeing times, and high diffusivities resulting in high extraction/ reaction rates.

Figure 8 shows the supercritical carbon dioxide apparatus which is usually used for dyeing of synthetic fibers. Fabric and dye are put in the container before starting the process. The apparatus is then sealed and heated to a pre-selected dyeing temperature and CO₂ is pumped simultaneously to the set pressure. The dyeing is carried out on textile depending on the type of fiber and then the pressure is slowly reduced to atmospheric at isothermal conditions (Li-qiu et al., 2005).

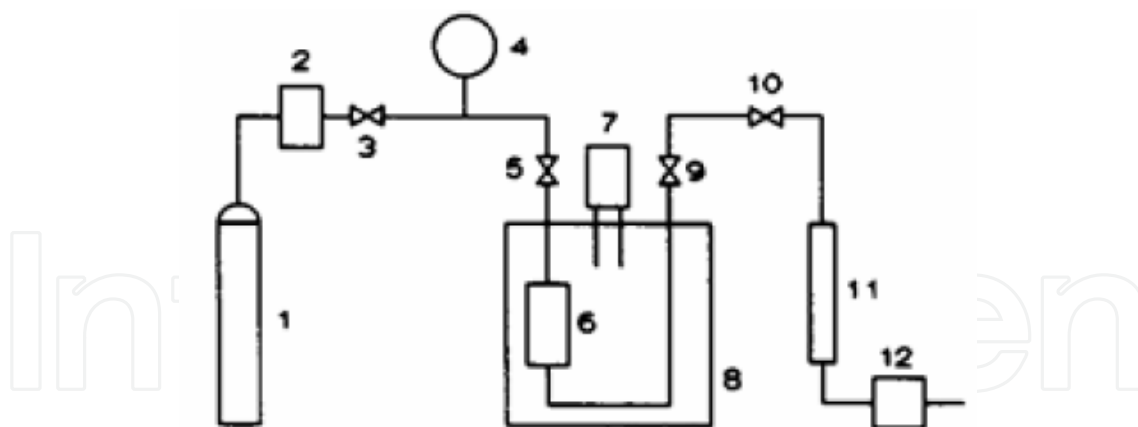

Fig. 8. The supercritical carbon dioxide apparatus used for dyeing of synthetic fibers 1. Liquid CO₂, 2. Pump, 3,5,9. Pressure-control valves, 4. Manometer, 6. Autoclave, 7. Temperature sensor, 8. Dyepot, 10. Adjust valve (Li-qiu et al., 2005)

Bach et al. dyed PP fibers in scCO₂ with different disperse dyes. They showed that disperse azo dyes with a naphthalene moiety gave much deeper colors on PP versus benzo-azo or anthraquinone dyes. They stated that improvement in dyeability is due to the changes in the crystal network of PP by the treatment in CO₂ as contrasted with PP dyed in water or air (Bach, 1998).

FTIR and NMR results obtained from Nylon 6,6 fabric samples that underwent $scCO_2$ dyeing of with a disperse-reactive dye confirmed a covalent bond with the fibers. Wash and light fastness of the fabrics showed satisfactory results. Their results indicated that fabric immersed in $scCO_2$ does not undergo any fiber damage (Liao et al., 2000). Shim et al. studied sorption of disperse dyes in PET and PTT textiles in the presence of $scCO_2$. They found that the dyeing rate increased monotonically with pressure at isothermal conditions and increased with temperature isobaric conditions (Shim et al., 2003). Generally, this method plasticizes the polymeric fibrous chains enhancing dye diffusion rates and increasing the ease of solvent removal. Moreover, it replaces water in dyeing processes, overcoming the problem of wastewater treatment.

2.2.3 Textile surface functionalization by vapor deposition methods (VDM)

Sputter coating is a significant technique producing functional nanostructured fibers. These functionalized fibers are essential for realizing their applications in microelectronic elements, photonics devices, and medical implants (Wei et al., 2006). Wei et al. used magnetron sputter coatings to generate functional nanostructures on polymer fiber surfaces. Conducting aluminum (Al) film, piezoelectric aluminum nitride (AlN) film, and ceramic film of aluminum oxide (Al_2O_3) were deposited onto PET fibers at low temperature. These nanostructured fibers have great potential for applications ranging from conductive shields, packing, and protective materials to electronic sensors.

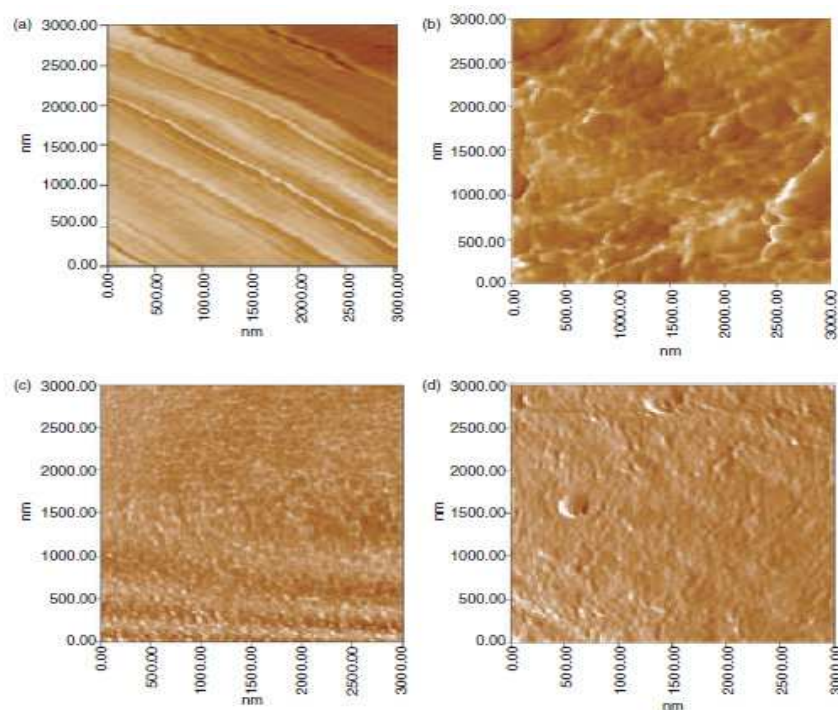

Fig. 9. Surface morphology of textile fiber: (a) original polypropylene fiber; (b) 20nm copper coated polypropylene fiber; (c) 50nm copper coated polypropylene fiber; and (d) 100nm copper coated polypropylene fiber (Wei et al., 2008).

Copper (Cu) nanocomposite textiles were prepared by magnetron sputter coating as discussed by other researchers. The surface conductivity of the textiles coated with Cu nanostructures showed a significant increase compared to the uncoated ones. The increased

coating thickness improved electrical conductivity (.cf **Figure 9**). The coated textiles also showed considerable improvement in UV and visible light shielding as examined by UV/Vis spectrometer (Wei et al., 2008).

2.2.4 Surface grafting

Covalent bonding of a molecule to most non-reactive synthetic surfaces such as polyolefins typically requires surface activation via one the physical methods described earlier. To this extent, graft peroxide-initiated polymerization of acrylamide (AAM) proceeded successfully on the ozonated surfaces described in Section 2.2.1. The SEMs in **Figure 10** clearly show the progression of the surface treatment to the final brush-like topography of AAM-grafted HDPE film (Gu et al., 2009). FTIR confirmed the presence of the amide groups with peak intensity at 1667 cm^{-1} increasing for the samples exposed longer to ozone treatment. Finally contact angle of the samples proceed from 74.92° for virgin HDPE to 38.55° for the AAM-grafted HDPE (cf. Inset of **Figure 10**). Grafting of AAM to the PU and PE films by Fujimoto et al. was favorable although the methodology was different (Fujimoto et al., 1993). In this case, thermal activation of the peroxide for AAM grafting occurred at lower temperature (60°C versus 85°C) for less time (3 hr versus 24 hr). The end result was still an outermost layer of polyacrylamide on the PU film as measured by FTIR, optical microscopy, and graft density determination by the ninhydrin method ($150\ \mu\text{g}\cdot\text{cm}^{-1}$). It was also demonstrated, however, that the grafting efficiency was reduced when the procedure was performed on PE film. This is attributed to lower levels of peroxides incorporated to the more chemically-resistant PE film as compared to PU film (Gu et al., 2009). These two surface modifications are categorized as “grafting from” methods as the peroxide initiator was tethered to the fiber surface prior to the polymerization reaction. When polymer chains are absorbed (and then subsequently reacted) to a solid surface, the correct term is “grafting to”. A thorough overview of this subject is provided by Minko (Minko, 2008).

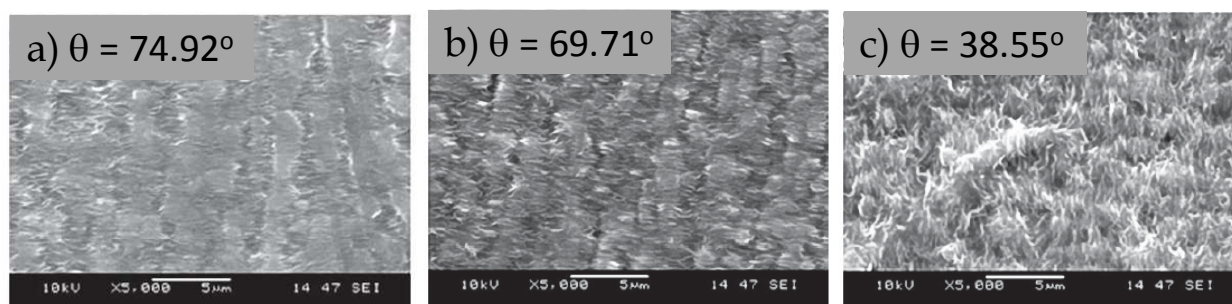

Fig. 10. SEM images of the morphology of the film surfaces (x 5000): a) Virgin HDPE film, b) HDPE film after ozonation in distilled water at 3.7 wt% for 1 hour, and c) AAM-grafted HDPE film ozonated in distilled water at 3.7wt% for 1 hour. Adapted from (Gu et al., 2009).

Polymerization processing parameters for the grafting of 4-vinyl pyridine to PET fiber was done to increase wettability and heavy-metal capture from aqueous media (Arslan, Yigitoglu, Sanli, & Unal, 2003). Similar to previous work (Hebeish, Shalaby, & Bayazeed, 1979; Shalaby, Allam, Abouzeid, & Bayzeed, 1976; Shalaby, Bayzeed, & Hebeish, 1978), benzoyl peroxide was used as the initiator. The researchers pre-swelled the fibers in dichloroethane to aid in the absorption of initiator and monomer prior to polymerization. They evaluated monomer concentration, initiator concentration, reaction temperature and

time to determine the optimum grafting conditions for a maximum yield of 70%. The incorporation of 4-vinyl pyridine resulted in a 40% increase of water absorption at the maximum graft yield. The chemical initiator immersion technique for benzoyl peroxide and ammonium persulphate was implemented for grafting acrylic acid onto polylactide fibers. Both techniques for grafting were inefficient to produce significant improvement in dyeability. They do note that layer-by-layer deposition provided surprising results in that the alternative barrier layer impeded the diffusion of oxygen thus prevention of polymer (PLA) degradation fibers. Dyeability as observed by K/ S values was also the highest for the layer-by-layer modification technique.

Table 1 contrasts four chemical reaction schemes to modify PET surfaces without physical modification (Chen & McCarthy, 1998; Nissen, Stevens, Stuart, & Baker, 2001). PET modification by glycolysis was determined most effective as measured by percent concentration of hydroxyl groups. The quantity of hydroxyl groups was assessed by X-ray photoelectron spectroscopy (XPS), dynamic contact angle (DCA) and labeling reactions. The labeling reactions combined with DCA are key results to conclude the increase effectiveness of glycolysis over hydrolysis and reduction of PET surfaces for incorporating hydrophilicity. Although XPS is surface sensitive to the first 100 angstroms, it is also performed in vacuum. Functionalizing the surface with non-polar moieties (fluorine) insure that their preferred orientation state is at the non-polar interface (air then vacuum) versus buried beneath the polymer surface. One final chemical reaction to be discussed for PET modification is aminolysis (Nissen et al., 2001). This reaction forms amide groups through the reaction of polyester's carbonyl with a primary amine. This reaction was done in the early 1960's to improve wettability, reduce static electricity and increase dyeability (Farrow, Ravens, & Ward, 1962; Kim & Ko, 1989). This reaction can be quite severe to the fibers with complete degradation as a result. To temper fiber degradation, long chain multifunctional amines such as tetraethylenepentamine (TTEPA) has been employed with favorable results (Nissen et al., 2001). While XPS showed no difference in % nitrogen content with reaction time, titration and DCA methods show an optimum wettability or amide content at 180 minutes. This indicated that the reaction was proceeding through the depth of the fiber which can also positively impact the diffusion of a dye throughout the fiber.

2.2.5 Enzyme surface modification of textiles

Processing with enzymes is one of the best environmental friendly applications of biotechnology in textile industry (Cavaco-Paulo & Gubitz, 2003; 2008; Agrawal et. al., 2008; Parvinzadeh et. al., 2009). Enzymes are biological catalysts that mediate virtually all of the biochemical reactions that constitute metabolism in living systems. They accelerate the rate of chemical reaction without themselves undergoing any permanent chemical change.

All known enzymes are proteins and consist of one or more polypeptide chains. The influence of many chemical and physical parameters such as salt concentration, temperature and pH on the rate of enzyme catalysis can be explained by their influence on protein structure. Some enzymes require small non-protein molecules, known as cofactors, in order to function as catalysts (Palmer & Bonner, 2007). Enzymes differ from chemical catalysts in at least two ways. Enzymes have far greater reaction specificity than chemically catalyzed reactions rarely forming by-products. In contrast to chemical catalysis, enzymes catalyze reactions under milder reaction conditions (temperatures way below 100°C), at atmospheric pressures and at neutral pHs (Cavaco-Paulo & Gubitz, 2003).

Reaction or molecule	Contact Angle of Water	%C/%O/%N (XPS)
 <p>a) Virgin PET surface</p>	$\theta_a = 77^\circ$ $\theta_r = 55^\circ$	71.5/ 28.5
 <p>b) Modification via Hydrolysis</p>	$\theta_a = 62^\circ$ $\theta_r = 16^\circ$	69.9/ 30.1
 <p>c) Modification via Reduction</p>	$\theta_a = 72^\circ$ $\theta_r = 32^\circ$	70.7/ 29.3
 <p>d) Modification via Glycolysis</p>	$\theta_a = 63^\circ$ $\theta_r = 25^\circ$	69.1/30.9
 <p>e) Modification via Aminolysis</p>	$\theta_a = 39.4^\circ$ @ 180 minutes	75.0/ 21.0/ 4.3 @ 180 minutes

Table 1. Chemical reactions to the surface of PET film or fiber with corresponding wettability (as measured by DCA) and XPS results; a)-d) adapted from (Chen & McCarthy, 1998) and e) from (Nissen et al., 2001).

In this section, we summarize how enzymes can be used to increase the hydrophilicity of selected synthetic polymers. Increase in hydrophilicity often leads to improved dyeability of the textile products. Enzymes are also used for the synthesis, surface functionalization and grafting of polymers that are used as textile fibers, however it is beyond the scope of this book chapter. We will discuss both the enzymes for hydrolysis of synthetic fibers as well as the test methods utilized for their characterization and performance.

2.2.5.1 Enzymatic hydrolysis of polyesters / PET

Enzymes are potential tools for PET hydrolysis (Vertommen et. al., 2005). As illustrated in Table 2, PET hydrolyzing enzymes belong to the hydrolase class (EC 3.1) such as cutinases, lipases and esterases (Vertommen et. al., 2005; Wang et. al., 2004; Battistel et al., 2001). PET was hydrolyzed by cutinases from organism *F. solani*, *F. oxysporum* and from *Pencillium citrinum*. Other PET-hydrolyzing enzymes are lipases, such as those from *Humicola sp.*, *Candida sp.*, *Pseudomonas sp.* and *Thermomyces lanuginosus* (Gubitz & Cavaco-Paulo, 2008). In addition to enzymatic hydrolysis, the simple adsorption of enzyme protein to the polymer can also increase the hydrophilicity of PET owing to the hydrophilicity of the protein. High crystallinity of PET polymers negatively affects the ability of the enzymes to hydrolyze which has already been shown for enzymes from *F. solani* and from *T. fusca* (Vertommen et. al., 2005; Cavaco-Paulo & Gubitz, 2008).

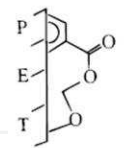
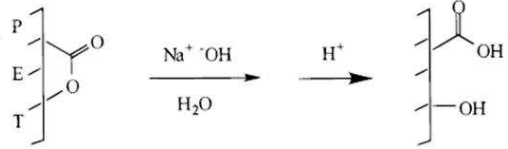
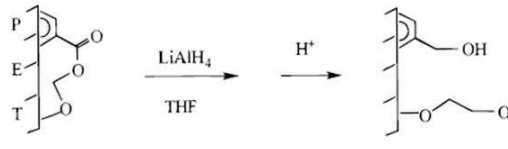
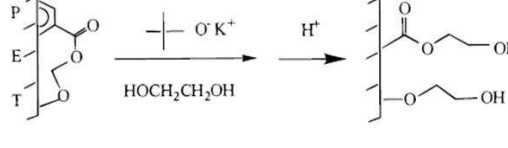
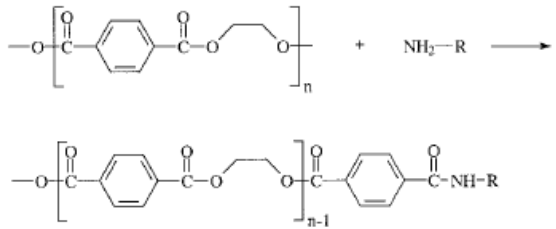
2.2.5.2 Enzymatic hydrolysis of polyacrylonitrile (PAN)

PAN (.cf **Figure 11**) is a collective name for all polymers that consist of at least 85% acrylonitrile monomer (BISFA, 2009). The homopolymer (100% acrylonitrile) is difficult to process and dye thus is only for industrial applications. The co-monomers in acrylic fibers are selected for fiber specific properties, such as dyeability with sodium methallyl sulfonate, sodium sulfophenyl methallyl ether, etc (Cavaco-Paulo & Gubitz, 2003).

Acrylic fibers comprising negative groups can be dyed with basic (cationic) dyes under carefully controlled conditions. Dyeing is usually performed in the presence of a retarder, which decreases the dyeing process rate for uniform shade reproduction. Finishing processes for PAN are limited since desirable properties can be more easily incorporated by copolymerization or by modification on the fiber level. For example, highly absorbent fibers are made by inclusion of a hydrophilic co-monomer which is subsequently removed by hydrolysis.

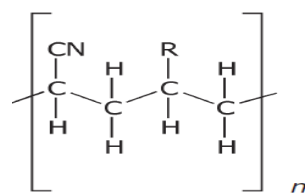

Fig. 11. Polyacrylonitrile 89-95% homopolymer, R = CN and up to 10% copolymer, R = vinyl acetate, COOH, SO₃H, OSO₃H etc

It has been shown that bacterial strains, such as *Micrococcus luteus*, can degrade PAN fibers. During this process, poly(acrylic acid) is released from PAN as confirmed by NMR analysis (Fischer-Colbrie et al., 2007). The release of poly(acrylic acid) from PAN, together with the formation of ammonia, was also shown for commercial nitrilases (Matama et. al., 2007). Several researchers converted the nitrile groups of PAN to the corresponding acids or amides by nitrilases or by an enzyme system comprising nitrile hydratase and amidase, respectively resulting in major increases in hydrophobicity (Tauber et. al., 2000; Fischer-Colbrie et al., 2007) (.cf **Table 2**). These changes in surface properties corresponded to an 80% increase in the surface oxygen-to-carbon (O/C) ratio attributed to enzymatic hydrolysis of the nitrile groups (Matama et. al., 2007). Commercial PAN-based materials usually contain around 7% vinyl acetate to reduce rigidity of the polymer. The vinyl acetate moieties in PAN can be hydrolyzed by cutinases and lipases, making this approach applicable to most commercially available PANs (Matama, et. al., 2006).

2.2.5.3 Enzymatic hydrolysis of polyamides (PA)

Enzymes such as proteases, amidases and cutinase can hydrolyse PA (.cf **Table 2**). A model substrate (adipic acid bishexyl-amide) has been developed for screening PA hydrolysis activity of given enzymes. It has been found that protease from *Beauveria sp.*, an amidase from *Nocardia sp.* and a cutinase from *F. solani pisi* can degrade the model substrate and correlated with PA hydrolysis activity (Heumann, et. al., 2006). For actual PA substrates; it has been demonstrated by Parvinzadeh et.al (2009) that protease treated Nylon 66 fabrics shows higher dye bath exhaustion with reactive and acid dyes. The intensity of major peaks in FTIR spectra of the protease treated samples is in favor of chemical changes of the polypeptide functional groups in the fabric. The results of color measurements showed that there is a direct co-relation between the concentrations of enzyme against the darker shade of the dyed fabric. In a separate study performed by the same researchers, it was confirmed that acid and disperse dyes showed higher exhaustion on the protease (Parvinzadeh, 2009) & lipase (Kiumarsi & Parvinzadeh, 2010) treated Nylon 6 samples.

Key Synthetic Fibers	EC 3: Hydrolase class of enzymes			Key Analysis Methods
	EC 3.1: enzyme acting on ester bond	EC 3.4: enzymes acting on peptide bond	EC 3.5: enzymes acting on carbon-nitrogen bonds, other than peptide bonds	
PET - Polyethylene terephthalate	Cutinase [1] Lipase [3] Serine esterase [4]	-	-	XPS, HPLC, NH ₃ formation, dye-binding assay [1,3,4]
PAN - Polyacrylonitrile	Cutinase ^a [6]	-	Nitrile hydrolase [2] Nitrilase [5]	XPS, NH ₃ formation, dye-binding assay [2] XPS, FTIR, SEM, dye-binding assay [5]
PA - Polyamide	Cutinase [3] Lipase [9]	Proteases [4, 9]	Amidase [7]	Release of oligomers, reactive dye-binding assay, hydrophilicity [3,7] FTIR, SEM, UV-vis spectrophotometer, thermal, dyeability, hydrophilicity [8-10].

^aPAN co-polymer with 7% vinyl acetate, FTIR: Fourier-transform infrared spectroscopy, SEM: scanning electron microscopy, HPLC: High Performance Liquid Chromatography, [1] = Vertommen et. al., 2005; [2] = Tauber et. al., 2000; [3] = Wang et. al., 2004; [4] = Battistel et al., 2001; [5] = Fischer-Colbrie et. al., 2006; [6] = Matama, et. al., 2006 ; [7] = Heumann, et. al., 2006; [8] = Parvinzadeh, 2009; [9] = Kiumarsi & Parvinzadeh, 2010; [10] = Parvinzadeh et. al., 2009

Table 2. Enzymatic modification of synthetic polymers

To conclude, in coming years, the textile industry will go towards sustainable technologies and developing environmentally safer methods for textiles processing. One way is the processing with enzymatic system, rather than conventional chemical methods. There are several ways to improve the dyeability of any synthetic fibers. However, enhancement of the hydrophilicity of synthetic polymers is a key requirement for better dyeability. Enzymes have proved to be environmental friendly tools for hydrolysis of synthetic polymers, specifically on the polymer surface, without compromises in polymer bulk properties. In general hydrolases class of enzymes (EC 3.1: cutinase, lipase, esterase, EC 3.4: protease and EC 3.5: nitrilase, nitril hydrolase, amidase etc) are used for improving hydrophilicity of synthetic fibers such as PET, PAN and PA respectively.

2.2.6 Modification of textile surfaces using sol-gel technique

A sol-gel technology is probably one of the most important developments in material science during the last decades. The sol-gel technique offers far reaching possibilities for creating new surface properties. Scientific literature demonstrates a wide array of functionalities that have been achieved by application of sol-gel coatings on textile surfaces. Its inorganic nature makes sol-gel layers very strong with nanometer-thick layers (Mahltig & Textor, 2008). Sol gel applications for textiles includes manipulation or changing

- Key textile properties e.g. stiffness, handle, absorbency, permeability etc.
- Surface properties e.g. hydrophobicity, hydrophilicity, abrasion resistance, photocatalytic activity, other barrier functions etc.
- Optical properties e.g. improving dyeability, photochromic effect, UV-absorption properties.
- Bio-active systems such as biocidal coatings, controlled release systems, immobilization of biological materials (enzyme, cells) etc.
- And other physical properties e.g. heat resistance, conductivity etc.

Sol-gel technology offers the possibility of tailoring surface properties to a certain extent, and combining different functionalities into a single material. The added advantage is that the application of sols can be carried out with techniques commonly used in the textile industry such as, a simple dip or padding process followed by a thermal treatment in a stenter frame.

2.2.6.1 The sol gel principle

The preparatory material or precursor used to produce the "sol" usually consists of inorganic metal salts or metal organic components, such as metal alkoxides (Mahltig & Textor, 2008; Chládová1, et. al., 2011). These precursors are subjected to a series of hydrolysis and polymerization reactions to create a colloidal suspension or "sol". This sol is deposited on the surface of materials, transferred into a gel and finally into a layer of oxide by heat treatment. In production and for research purposes, SiO₂ and TiO₂ layers are deposited most often. Also, layers of many other compositions containing Al₂O₃, B₂O₃, ZrO₂, PbO and other oxides are often prepared. Next to the clearly inorganic layers, hybrid inorganic-organic layers have also been developed (production terms ORMOCER, ORMOSIL and NANOMER), which contain both chemical bonding of organic substances and functional groups next to silicon, titanium, zirconium and oxygen (Chládová, et. al., 2011).

2.2.6.2 Dyeing of textiles based materials

Currently, we are observing an intensive increase in the production of textiles made of synthetic polymers. Synthetic fibers have high mechanical properties and are extremely rigid apart from other properties such as having low porosity and lower swelling etc. These properties are directly related to low dyeability with the standard dyeing technology. Synthetic fibers normally have a high glass transition temperature which makes it impossible for the dye molecule to penetrate into the fibers, especially when using water (H₂O) as a solvent. In some cases, it is possible to use other solvents or other fiber-swelling compounds to reduce the glass transition temperature of fibers. **Table 3** illustrates some key examples of sol gel method applied on textile based materials to improve its dyeability.

Materials/ Fabric	Dye(s)	Technique / key results	Reference
Polyester /Viscose	Rhodamine B, Naphthol Blue Black, Metanil Yellow & Bismarck Brown R	Dyes immobilized modified silica sol to reduce dye leaching from the substrate.	(Nedelčev et. al., 2008)
Polyester (PET)	Disperse Blue 56	Sol was prepared by hydrolysis of tetraethoxysilane (TEOS) in presence of HNO ₃ and H ₂ O, for deposition of porous SiO ₂ film on polyester fabric.	(Barabi et. al., 2010)
Glass fibers	Total 12 dyes belongs to cationic dyes, disperse dyes & metal complex dyes	The sol is the blending of 3- trimethoxysilyl propyl methacrylate in isopropanol with supporting chemicals (water, HCl, benzoyl peroxide).	(Chládova, et. al., 2011)
Glass	pH sensitive dye methyl red (MR), tropaeolin (TO) and bromocresol green (BCG).	The sol-gel consisted of 50% tetraethoxysilane (TEOS) and 50% methyltriethoxysilane (MTEOS) (w/w).	(Ismail, et. al., 2011)
Titanosilicates	Azo dye Orange II	Functionalization of the titanosilicates with ethylenediamine groups was carried out via the sol gel process, using the hydrolytic route followed by dyeing.	(Marc, al, L. et. al., 2011)

Table 3. Improving dyeability of various textile based materials using sol gel method.

In the surface treatment of polymer structures, it is necessary to use hybrid layers based on a mixture of inorganic and organic polymer compounds, which are connected at the end of the process to a single macromolecular network (*cf* **Table 3**). The inorganic part is linked with chemical, mechanical and thermal stability. The application of sol gel technology for improving dyeability is still at relatively early stage of development. However, looking at the trends, it is expected that sol gel technology will play important role towards improving dyeability and bringing new functionality together.

2.2.7 Nano-modifications of textiles surfaces using layer-by-layer deposition methods

A variety of functional thin films can be produced using the layer-by-layer (LbL) assembly technique (Ariga, Hill, & Ji, 2007; Decher, 2003). LbL-based thin films are currently being

evaluated for properties that include antimicrobial (Dvoracek, Sukhonosova, Benedik, & Grunlan, 2009; J. H. Fu, Ji, Yuan, & Shen, 2005; J. Fu, Ji, Fan, & Shen, 2006), anti-reflection (Hiller, Mendelsohn, & Rubner, 2002), electrical conductivity (Park, Ham, & Grunlan, 2011), anti-flammable (Carosio, Laufer, Alongi, Camino, & Grunlan, 2011; Li et al., 2010; Li, Mannen, Schulz, & Grunlan, 2011), gas barrier (Priolo, Gamboa, & Grunlan, 2010; Priolo, Gamboa, Holder, & Grunlan, 2010; Yang, Haile, Park, Malek, & Grunlan, 2011), and UV resistance (Dawidczyk, Walton, Jang, & Grunlan, 2008). These films, typically $< 1\mu\text{m}$ thick, are created by alternately exposing a substrate to positively- and negatively-charged molecules, polymer electrolytes, or particles, as shown in **Figure 12**. Steps 1 - 4 are continuously repeated until the desired number of “bilayers” (or cationic-anionic pairs of layers) is achieved. **Figure 12b** provides an illustration of a film deposited with cationic and anionic polymers. Individual layers may be 1 - 100+ nm thick depending on chemistry, molecular weight, charge density, temperature, deposition time, counterion, and pH of species being deposited. The ability to control coating thickness down to the nm-level, easily insert variable thin layers without altering the process, avoid disturbing intrinsic mechanical behavior of the substrate, and process under ambient conditions are some of the key advantages of this deposition technique. In nonwovens, each thread can be individually coated with a uniform LbL nanocoating and still remain soft and flexible.

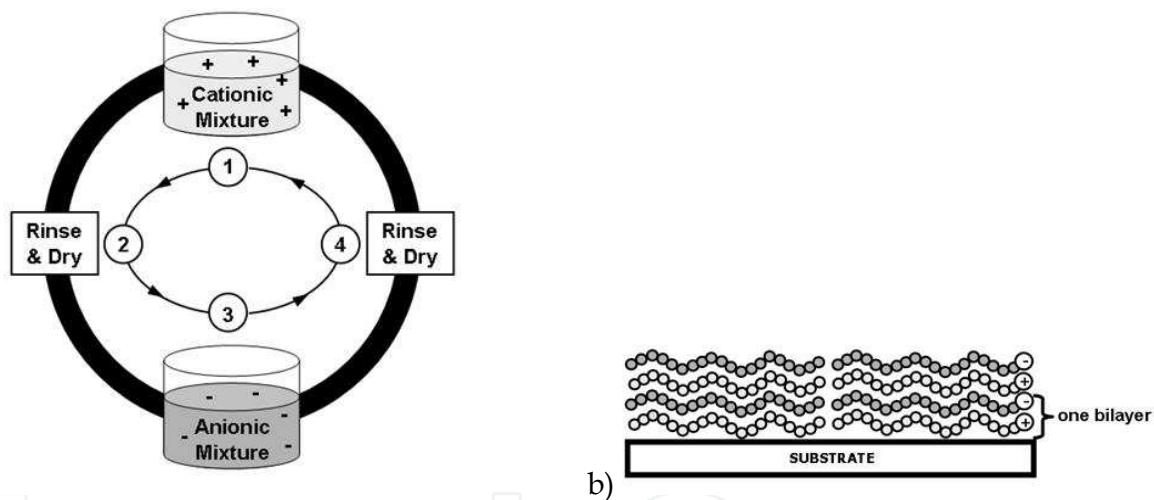

Fig. 12. a) Schematic of layer-by-layer deposition process used to prepare functional thin films and b) steps 1 - 4 are repeated until the desired number of bilayers are generated on a substrate. From (Jang & Grunlan, 2005)

Surface roughness of materials has been intensely studied over the last decade. When this aspect is coupled with low surface energy components, “rough” materials become superhydrophobic. Oleophobicity also comes into play when the material becomes nanoporous, minimizing void volume between molecular substituents, preventing wetting of low surface tension liquids in addition to polar liquid (i.e. water) (Zenerino, Darmanin, de Givenchy, Amigoni, & Guittard, 2010). Designing superhydrophobic surfaces via the layer-by-layer assembly method have included covalently bonded interlayers (Amigoni, de Givenchy, Dufay, & Guittard, 2009), integrated organic and inorganic components, and induced micro-roughness from the underlying substrate to mimic the back of the *Stenocara* beetle where the hydrophilic/ superhydrophobic regions allow self-cleaning surfaces (Garrod et al., 2007; Zhai et al., 2006). Interesting alternating layers of the anionic and

cationic mixtures have allowed for facile fabrication of the resultant surface chemistries. To further enhance the viability of the LbL technique for organic polymers, pH-amplified exponential growth LbL self-assembly was implemented for poly(ethylenimine) (PEI) and poly(acrylic acid) PAA as the polycation and polyanion respectively. This technique takes advantage of the synergistic effect of the pH-dependent tunable charge density and weak polyelectrolyte diffusivity. The end result is fast LbL layer formation in a limited number of deposition cycles. This research proved that only three bilayers were necessary to achieve a lotus-like superhydrophobic surface (.cf **Table 4**) (Sun, Shen, Wang, Fu, & Ji, 2010).

Property	Polycation	Polyanion
Super-Hydrophobicity From (Sun et al., 2010)	PEI  Polyethylenimine	PAA
Super-Hydrophilicity From (Grunlan, 2011)	PDDA  Poly(diallyldimethyl ammonium chloride)	PAA  Poly(acrylic acid)
Switchable -philic/-phobic From (Lim et al., 2006)	PAH  poly(allylamine hydrochloride) Inorganic-Organic Hybrids to induce roughness with azofunctional moieties	SiO ₂ 

Table 4. Polyelectrolytes for LbL formulations with imparted functionality.

LbL deposition of polyelectrolytes can also be used to impart a hydrophilic surface to polyolefins. In the case of polyethylene, this would be useful for high performance fibers that might eventually be used for athletic clothing to wick away moisture as well as increase dye receptivity. With a contact angles (θ_{dH_2O}) around 70°, polyethylene (PE) surfaces could actually be called slightly hydrophilic. In reality, contact angles below 45° are typically needed for a surface to exhibit facile wetting by a water droplet or hydrophilic behavior. **Table 4** shows a matrix of polymer polyelectrolytes that are used for imparting various finishes to substrates via LbL deposition. Specifically implemented by the Grunlan laboratory to determine the possible hydrophilic coatings onto PE, 2.5 bilayers were needed to achieve a θ_{dH_2O} of 22° when using the system of poly(diallyldimethylammonium chloride) (PDDA-PAA) as compared to other systems comprising 6 or more bilayers. The elevated pH of PAA (pH = 5) created an increased negative charge density and thinner deposition relative to unmodified PAA (pH < 3). Additionally, stopping deposition at half bilayers, where PDDA was at the surface, proved much more hydrophilic than full bilayers due to its

high charge density (Grunlan, 2011). They also noticed upon further evaluation, full bilayers of PDDA-PAA (pH = 5) had a contact angle of 11 degrees. This near superhydrophilic value is much lower than the initial screening attributed to a more pristine PE film cleaning and controlled polyelectrolyte deposition. The half bilayer protocol, with PDDA at the film's surface, had contact angles that could no longer be measured (i.e., < 5 degrees), suggesting a superhydrophilic surface. This was shown to be reproducible and unchanging as the assembly was built from 2.5 to 6.5 bilayers.

Another unique utilization of LbL deposition was demonstrated by Cho and researchers (Lim, Han, Kwak, Jin, & Cho, 2006). They formed a nanoporous substrate with microscale roughness through alternating electrostatic deposition of poly(allylamine hydrochloride) (PAH) as the polycation and SiO₂ nanoparticles as the polyanion for a substrate with reversible wetting properties. The exposed SiO₂ layer was treated with 3-(aminopropyltrichlorosilane) providing reactive binding sites (-NH₂) for photo-switchable moieties (7-[(trifluoromethoxyphenylazo)phenoxy]pentanoic acid (CF₃AZO)). The CF₃AZO moieties in vis (440nm) light are in a hydrophobic *trans* orientation but orient to a *cis* state upon exposure to UV (365 nm) light. After the LbL-CF₃AZO fabrication, the surface measured contact angles up to 156°, as dictated by the number of bilayers (.cf Figure 13a). In contrast, the contact angle of water for a CF₃AZO-functionalized flat film measured 76° (θ_{dH_2O}). The flat surface after exposure to UV light for 10 minutes, demonstrated a contact angle change of 5°, whereas the LbL functionalized surface could switch between being superhydrophobic at 156° to superhydrophilic at < 5°, for nine bilayers. This reversibility was repeated up to 5 cycles with essentially zero hysteresis (see Figure 13b).

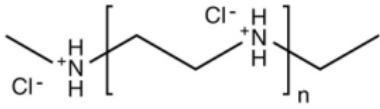
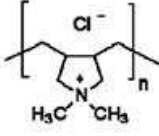
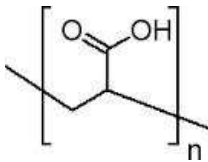
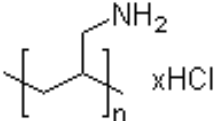
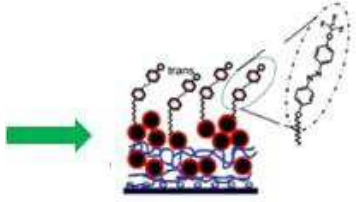
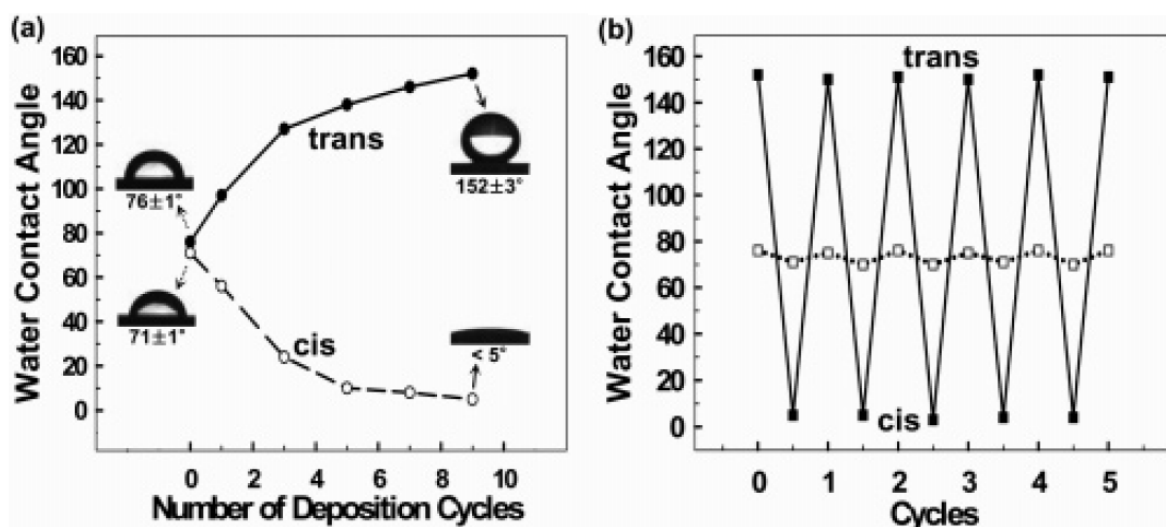

Fig. 13. a) the number of LbL bilayers necessary to induce super-hydrophobicity/ super hydrophilicity on CF₃AZO-LBL surfaces and b) corresponding reversibility for the nine bilayer surface after UV/Vis exposure. Adapted from (Lim et al., 2006).

To conclude, LbL deposition is a unique surface modifying technique that gives ultimate flexibility for the design of the surface. Challenges for this technique include cost-effective commercial implementation at high on-machine line speeds for continuous operations. Engineering creativity to meet this challenge holds promise for a facile surface treatment technology for textiles.

2.2.8 Micro-encapsulation method to enhance dyeing process

Microencapsulation is actually a micro-packaging process involving the production of microcapsules. These materials act as barrier walls of different solids or liquids as cores. The wall has the ability to protect the core from hazardous environments, i.e. oxidization, heat, acidity, alkalinity, moisture or evaporation. They are produced by depositing a thin polymer coating on small solid particles or liquid droplets, or on dispersions of solids in liquids. The core contents are released under controlled conditions to suit a specific purpose (Cheng et al., 2008).

The most commonly methods used for preparation of microencapsules are complex coacervation, polymer-polymer incompatibility, interfacial polymerization and in situ polymerization, spray drying, centrifugal extrusion, air suspension coating, pan coating and emulsion hardening method (Cheng et al., 2008). In dyeing of synthetic fibers, the major interest in microencapsulation is currently in the application of dyes as core and liposome as shell. Liposomes are artificially prepared vesicles made of lipid bilayer that can be filled with various materials. They comprise naturally-derived phospholipids with mixed lipid chains (.cf **Figure 14**).

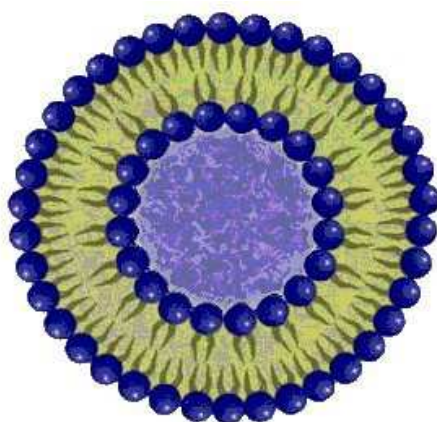

Fig. 14. Structure of liposome.

Gomez and Baptista studied microencapsulation of the dye in liposomes with lecithin from soy as an alternative to retarding and leveling agents. Liposomes were prepared with soy lecithin at different concentrations, containing the commercial acid dye C.I. Acid Blue 113. The effect on the dyeing rate of the microencapsulated dyes was compared with that from common retarding and leveling agents. The influence of surfactants on the stability of the liposomes and hence on the exhaustion curves of the dyeing was also evaluated. Interesting results obtained from exhaustion curves of anionic and non-ionic surfactants compared with commercial retarding and leveling agent (Gomez & Baptista, 2001).

Marti et al. used phosphatidylcholine liposomes instead of synthetic surfactants as dispersing agent for disperse dyeing. They calculated the turbidity ratio to assess the dispersion behavior of different liposome-dispersed dye preparations compared with commercial dye forms. Results indicated that liposomic preparations diminish the aggregation of dye molecules that normally occurs at high temperatures. They also found the potential efficacy of liposomes as natural surfactants which can be applied to disperse dye formulations to dye polyester fibers with good dye exhaustion and washing fastness. This environmentally friendly biological surfactant, phosphatidylcholine, duly structured as

liposomes, can substitute high amounts of synthetic dispersing agents in disperse dye formulations (Marti et al., 2011).

Yan et al. suggested microencapsulated disperse dyes to dye PET in the absence of auxiliaries and without reduction clearing. They studied the dyeing behaviors and dyeing kinetic parameters of microencapsulated disperse dye on PET compared with those of commercial disperse dyes with auxiliary solubilization. Their results showed that the dyeing behaviors of disperse dye are influenced greatly by microencapsulation. The diffusion of disperse dyes from microcapsule onto fibers can be adjusted by the reactivity of shell materials and mass ratios of core to shell. The disparity of diffusion between two disperse dyes can be reduced by microencapsulation. In addition, the microencapsulation improves the utilization of disperse dyes due to no auxiliary solubilization (Yan et al., 2011).

2.2.9 Micro surface modification of textiles by aqueous solutions

Alkaline, acidic and solvents hydrolysis is another method to improve various physical and chemical properties of synthetic fibers (Shcherbina et al., 2008; Park et al., 2009; Veronovski et al., 2009; Barantsev et al., 2007; Konovalova & Rabaeva, 2007; Chapurina et al., 2005; Hou et al., 2009). Alkaline hydrolysis has been studied extensively to overcome some problems of low water absorption properties and softness as alkaline hydrolysis improves the water absorption properties and softness of the PET fiber to give it a character similar to that of natural fibers (Prorokova et al., 2009; Chu et al., 2005). The alkaline hydrolysis of PET fibers is usually carried out with an aqueous alkaline solution, such as sodium hydroxide. In the alkaline hydrolysis process, PET undergoes a nucleophilic substitution. Chain scission of PET occurs, resulting in a considerable weight loss and the formation of hydroxyl and carboxylate end groups, which improves the handling, moisture absorption and dyeability of the fabric with enhanced softness (Mikhailova et al., 2008; Prorokova & Vavilova, 2004; Sohn et al., 2007; Stakne et al., 2003, Akbarov et al., 2006; Pavlov et al., 2001).

The effects of pretreatment reagents on the hydrolysis and physical properties of PET fabrics were investigated under various alkaline hydrolysis treatment and pretreatment conditions by Kim and his colleagues. Solvents used for pretreatment included benzyl alcohol and 2-phenyl ethanol. Results indicated that fabric weight loss, crystallinity, the initial and maximum water absorption increased with increasing hydrolysis time (Kim et al., 2009).

Jain et al. reduced multi-filamentous polyacrylonitrile (PAN) fibers to amino groups using lithium aluminum hydride for immobilization of antibodies and detection of analyte. 24 h reduced fibers gave the most stable and reproducible results on immobilization of antibodies. Modified PAN fibers had a strong potential to be used as matrix for the detection of pathogenic bacteria and medical diagnostics (Jain et al., 2009). Another approach carried out by Cui and Yoon to modify the surface of PET film by treatment with ethoxylated hexylaminoanthraquinones synthesized by the reaction of 1-aminoanthraquinone with poly(ethylene glycol)s via hexamethylene spacer. The ethoxylated hexylaminoanthraquinones were adsorbed only onto the extreme surface of PET and water contact angle was decreased by the adsorption (Cui & Yoon, 2003).

A comprehensive collection of wet-chemical analyses of oxidized surfaces of poly(ethylene terephthalate) or polyolefin was presented by Knittel and Schollmeyer. Advanced oxidation of textile samples has been done using ozone and UV functionalization. They claimed that method presented uses inexpensive equipment and can be done quickly in a normal lab even as a process control (Knittel & Schollmeyer, 2008).

3. Bulk modification of synthetic textiles using nanomaterials

In recent years, synthetic polymer-nanometric filler composites have generated significant attention in diverse applications such as transportation vehicles, construction materials, electronics, sporting goods, packaging, household and textile industries (Sinha Ray & Okamoto, 2003; Leszczyńska et al., 2007a). The aim is to enhance a wide range of properties including mechanical properties (modulus, stiffness and strength), barrier, flame retardancy, solvent and heat resistance, biodegradability, chemical and thermal stability as well as improvement in dyeability relative to a virgin polymer (Leszczyńska et al., 2007b, Pesetskii et al., 2007). In order to obtain these specifications, fillers such as cellulose, clay, calcium carbonate, carbon, metal oxides and various forms of silica have been developed by different researchers. In this regard, the geometrical shape of the particles plays an important role in determining the properties of composites (Bhat et al., 2008; Njuguna et al., 2008; Ma et al., 2003).

Processing of such polymeric nanocomposites are more difficult compared to the corresponding pure polymers since such inorganic nanoparticles have strong tendencies to agglomerate. To overcome such difficulties, the sol-gel method, LbL deposition, in situ polymerization and melt processing are put into practice. The last method is still the most cost effective, simple, feasible and environmentally benign process for the mass production of polymeric nanocomposite (Burgentzle et al., 2004; Modestia et al., 2007).

Considerable efforts have been devoted to improve various physical, mechanical and barrier properties of PET through mixing it with nanoclays (Phang et al., 2004; Chang et al., 2004; Chang et al., 2005; Jawahar et al., 2005). The layered clays used are mica, fluoro-mica, hectorite, saponite, etc., but one of the most commercially interesting clay is bentonite belonging to a structural family known as the 2:1 phyllosilicates (Calcagno et al., 2007). It is well known that the clay minerals have also been used as adsorbent for removal of acid, reactive, disperse and basic dyes from aqueous solutions due to the fact that they are globally abundant and inexpensive (Xiao et al., 2005). Their inner layers comprise an octahedral sheet, which is situated between two tetrahedral sheets. The substitutions of Al^{3+} for Si^{4+} in the tetrahedral layer and Mg^{2+} or Zn^{2+} for Al^{3+} in the octahedral layers result in a net negative surface charge ion in water which cause the repulsion interaction with anionic dyes (Parvinzadeh & Eslami, 2011).

The dyeability of synthetic fibers depends on their physical and chemical structure. Dyeing process consist of three steps including the diffusion of dye through the aqueous dye bath on to the fiber, the adsorption of dye into the outer layer of the fiber and the diffusion of dye from the adsorbed surface into the fiber interior. It was shown by researchers that functional groups of PET and water molecules play a great role in this process. The terminal carboxylic and hydroxyl groups in PET chains interact with water molecules. This makes a swelled fiber resulting to increase the attraction of disperse dye by these functional groups of fiber (Kirk-Othmer, 1998).

The proportion of crystalline and amorphous regions of polymer is another factor influencing the dyeability. Researchers are concerned with the development and implementation of new techniques in order to fulfill improvement in dyeability of various polymers. Blending of polymeric fibers with nanoclays as inexpensive materials is still claimed as cost effective method to enhance dyeability (Geoghegan & Krausch, 2003). Up to now, only two research articles are focused on dyeing properties of polypropylene- and polyamide 6- layered clay incorporated nanocomposites prepared by melt compounding

(Razafimahefa et al., 2005; Toshniwal et al., 2007). Toshniwal et al. suggested that polypropylene fibers could be made dyeable with disperse dyes by addition of nanoclay particles in polymer matrix (Toshniwal et al., 2007). Another research work done by Razafimahefa and her colleagues showed that the introduction of the nanoclay improves the dyeing ability of nylon with disperse dyes. Nevertheless, because of the interactions between the anions in montmorillonite and the amino groups on the polyamide, the dyeing sites are occupied with the nanoclay. This led to inferior dyeing with acid or metal complex dyes than in the case of the unfilled polymer (Razafimahefa et al., 2005).

Our previous study on dyeability of PET/clay nanocomposites stated the following type of interactions between the disperse dye and clay surfaces:

- Hydrogen bonding between OH groups of modified clays and the NH_2 and CO groups of disperse dye molecules.
- Electrostatic bonding between the negatively charged oxygen atom of carbonyl groups in disperse dye molecule and positively charged nitrogen atom of quaternary ammonium salt in modified clays.
- Direct π interactions and van der Waals forces between methyl and ethyl groups of modified clays on one hand and methoxy group and benzene rings of disperse dye molecule on the other hand.

The second reason for improving disperse dye absorption of PET/clay nanocomposites could be the relatively large voids between clay platelets after modification with quaternary ammonium salts (Parvinzadeh et al., 2010a; Parvinzadeh et al., 2011). It was shown that the surface morphology of PET/clay nanocomposites has great influence on water contact angle of the resultant nanocomposite (.cf **Figure 15**).

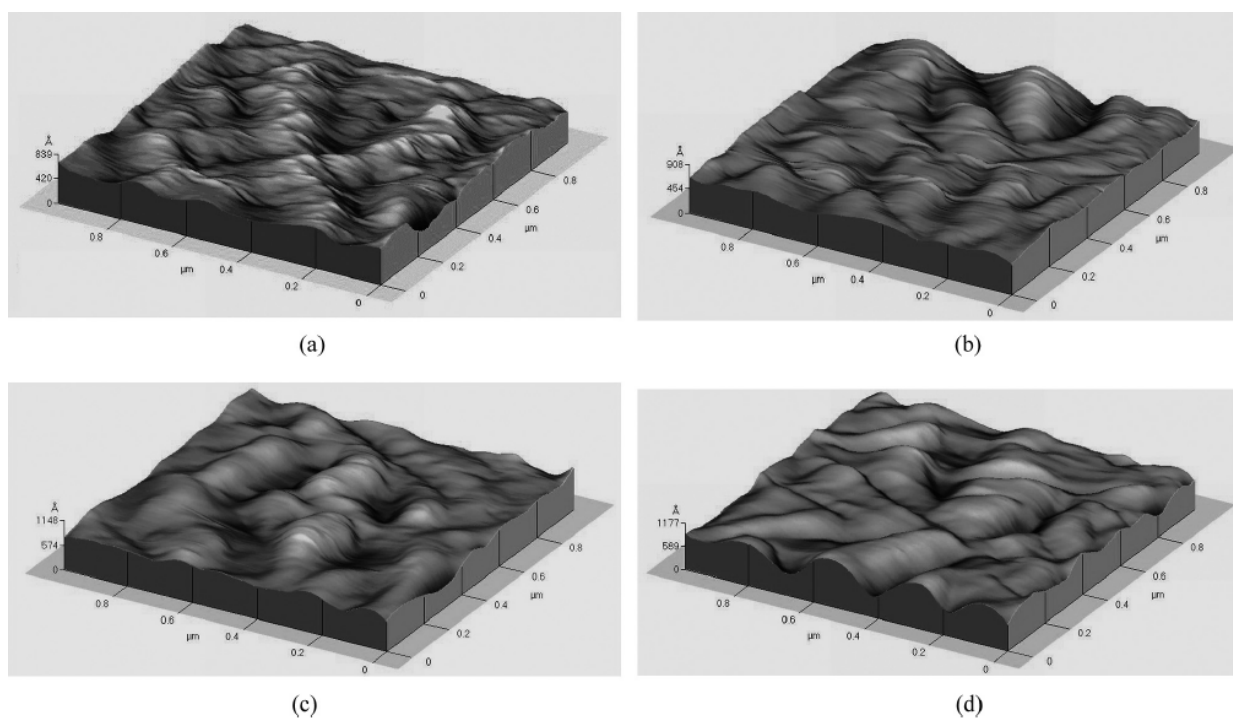

Fig. 15. 3d topographic images of atomic force microscopy for various composites: (a) Pure PET, (b) PET=15A, (c) PET=30B, (d) PET=Na⁺ (Parvinzadeh et al., 2010a).

Another applicable nanofiller is silica nanoparticle which impacts high stiffness, tensile strength, modulus, toughening, crystallinity, viscosity, creep resistance, coefficient of friction, wear resistance, toughness and interfacial adhesion in various polymer nanocomposites (Xanthos, 2005, Parvinzadeh et al., 2010b). Recently, a research program to explain dyeability of PET/silica nanocomposite was done by Yang and Gu. They used *in situ* polymerization to prepare PET/SiO₂ nanocomposites. According to the results, the color strength of the dyeing increased with increasing SiO₂ content in polymer (Yang & Gu, 2007).

Over the last 20 years polymer chemistry has created a non-linear polymeric structure coined dendritic polymers. Their architecture arises from the introduction of a large number of branches with many functional end groups (Froehling, 2001).

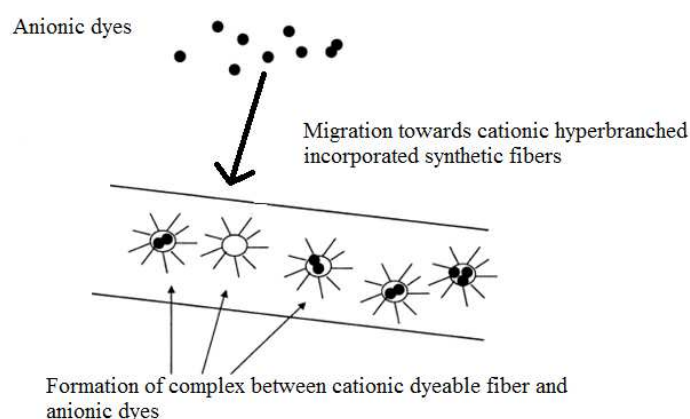

Fig. 16. Incorporation of hyperbranched polymers into the fiber structure (Froehling, 2001)

Two classes of these polymers are dendrimers with a perfectly branched uniform structure and hyperbranched polymers with non-uniform ones. It was already suggested by different authors that highly branched molecules should be able to act as a host for the encapsulation of guest molecules of dyes or a dendritic box. This structure can lead to industrial development of dyeable poly(propylene) fiber (Froehling, 2001) (.cf **Figure 16**). Other authors suggested that an improvement in dyeability of the polymeric- hyperbranched additive nanocomposites can be attributed to the decrease in glass transition temperature and the lower crystallinity of the polymers (Khatibzadeh et al., 2010).

4. Remarks and outlook

Various types of physical and chemical finishing methods have been described in this chapter. Most of them are developed to solve problems with synthetic fibers to expand their usefulness. Examples of such problems are their insufficient fabric softness, low absorbency of water, flammability, and pilling, low dyeability, slipping and static problems during production and usage. New finishing processes using physical and chemical methods can solve these problems and restrictions. Both the improved and the newly developed finishes based on nano-science are valuable tools that can project an enhanced image of the finish producers for the next textile industry revolution.

5. Acknowledgements

The authors thank Prof. Jaime Grunlan at Texas AMU for his fruitful discussion of LbL modifications to textiles surfaces. We would also like to thank Prof. Ahmed El-Shafei for his insights on atmospheric plasma polymerization.

6. References

- Agrawal, P.B. et al., (2008). Role of mechanical action in low-temperature cotton scouring with *F. solani* pectinase and pectate lyase. *Enzyme & Microbial Technology*, Vol. 42, No. 6, (May 2006), pp. 473-482, ISSN 0141-0229
- Aizenshtein, E. M. (2008). Polypropylene Fibres and Yarns in the Current State of Development. *Fibre Chemistry*, Vol. 40, no.5 pp. 399-405.
- Akbarov, D., Baymuratov, B., Westbroek, P., Akbarov, R., Clerck, K.D. & Kiekens, P., (2006). Development of electroconductive polyacrylonitrile fibers through chemical metallization and galvanization, *Journal of Applied Electrochemistry*, 36, pp. 411-418.
- Alberti, A., Bertini, S., Gastaldi, G., Iannaccone, N., Macciantelli, D., Torri G. & Vismar, E., (2005). Electron beam irradiated textile cellulose fibres.: ESR studies and derivatisation with glycidyl methacrylate (GMA), *European Polymer Journal*, 41, pp. 1787-1797.
- Amigoni, S, de Givenchy, ET, Dufay, M, & Guittard, F. (2009). Covalent layer-by-layer assembled superhydrophobic organic-inorganic hybrid films. *Langmuir*, 25, 18, SEP 15, pp. 11073-11077, ISSN 0743-7463.
- Ariga, K, Hill, JP, & Ji, Q. (2007). Layer-by-layer assembly as a versatile bottom-up nanofabrication technique for exploratory research and realistic application. *Physical Chemistry Chemical Physics*, 9, 19, pp. 2319-2340, ISSN 1463-9076.
- Arslan, M, Yigitoglu, M, Sanli, O, & Unal, HI. (2003). Kinetics of swelling assisted grafting of 4-vinyl pyridine onto poly(ethylene terephthalate) fibers using a benzoyl peroxide initiator. *Polymer Bulletin*, 51, 3, NOV, pp. 237-244, ISSN 0170-0839.
- Bach, E., Cleve, E., Schollmeyer, E., Bork, M. & Korner, P., (1998). Experience with the UHDE CO₂-dyeing plant on technical scale, part I: optimization steps of the pilot plant and first dyeing results. *Melliand International*, 3, pp. 192-194.
- Barabi, H., et al., (2010). Enhanced Deep Coloring of Micro Polyester Fabric. *Materials Science*, Vol. 16, No. 2, pp. 138-143, (July 2010), ISSN 1392-1320
- Barantsev, V. M., Larionov, O. S. & Pavlov, N. N. (2007). Prospects for modification of para-aramid fibres with metal complex salts in conditions of microwave exposure, *Fiber Chemistry*, 39, pp. 193-196.
- Battistel, E. et al. (2001). Enzymatic surface modification of acrylonitrile fibers. *Applied Surface Science*, Vol. 177, No. 4, (June 2001), pp. 32-41, ISSN 0169-4332
- Bhat, G., Hegde, R.R., Kamath, M.G. & Deshpande, B. (2008). Nanoclay reinforced fibers and nonwovens, *The Journal of Engineered Fibers and Fabrics* 3, pp. 22 - 34.
- BISFA - The International Bureau For the Standardization of Man-Made Fibres (2009), *Terminology of man-made fibers 2009 Edition*, Brussels, Belgium.
- Borcia, G., et al. (2006). Using a he + N₂ dielectric barrier discharge for the modification of polymer surface properties, *Plasma Sources Science and Technology*, 15(4) 849.

- Brzezinski, S, Kaleta, A, Kowalczyk, D, Malinowska, G, & Gajdzicki, B. (2010). Effect of changes in the nanostructure of the outer layer of synthetic fibers on their dyeing properties. *Fibres & Textiles in Eastern Europe*, 18, 4, OCT-DEC, pp. 92-98, ISSN 1230-3666
- Burgentzle, D., Duchet, J., Ge´rard, J.F., Jupin, A. & Fillon, B. (2004) Solvent-based nanocomposite coatings. I. Dispersion of organophilic montmorillonite in organic solvents, *Journal of Colloid & Interface Science* 278, pp. 26 - 39.
- Calcagno, C.I.W., Mariani, C.M., Teixeira, S.R. & Mauler, R.S. (2007) The effect of organic modifier of the clay on morphology and crystallization properties of PET nanocomposites, *Polymer* 48, pp. 966 - 974.
- Carosio, F, Laufer, G, Alongi, J, Camino, G, & Grunlan, J.C. (2011). Layer-by-layer assembly of silica-based flame retardant thin film on PET fabric. *Polymer Degradation and Stability*, in press.
- Cavaco-Paulo, A. & Gubitz, G. (2003). *Textile processing with enzymes*, Woodhead Publishing Series in Textiles No. 29, ISBN 1 85573 610 1, Cambridge, UK
- Chang, J.H., Kim, S.J., Joo, Y.L. & Im, S. (2004) Poly(ethylene terephthalate) nanocomposites by in situ interlayer polymerization: the thermo-mechanical properties and morphology of the hybrid fibers, *Polymer* 45, pp. 919 - 926.
- Chang, J.H., Mun, M.K. & Lee, I.C. (2005) Poly(ethylene terephthalate) nanocomposite fibers by in situ polymerization: the thermomechanical properties and morphology, *Journal of Applied Polymer Science* 98, pp. 2009 - 2016.
- Chapurina, M. A., Gal'braikh, L. S., Redina, L. V., Sletkina, L. S., Igumnov, S. M., Maksareva, E..Y & Narinyan, K. E., (2005) New fluorine-containing polymers for modification of the surface properties of chemical fibers, *Fiber Chemistry*, 37, pp. 81-83.
- Chen, W, & McCarthy, T.J. (1998). Chemical surface modification of poly(ethylene terephthalate). *Macromolecules*, 31, 11, JUN 2, pp. 3648-3655, ISSN 0024-9297.
- Cheng, S.Y., Yuen, C.W.M., Kan, C.W. & Cheuk, K.K.L. (2008) Development of cosmetic textiles using microencapsulation technology, *RJTA*, 4, pp. 41-51.
- Chládoová, A., et al. (2011). Dyeing of glass fibers by the sol gel method. *AUTEX Research Journal*, Vol. 11, No. 1, pp. 18 -23, (March 2011), ISSN: 14709589
- Chu, Y. C., Tseng, C. H., Hung, K. T., Wang, C. C. & Chen, C. Y., (2005). Surface modification of polyacrylonitrile fibers and their application in the preparation of silver nanoparticles, *Journal of Inorganic and Organometallic, Polymers and Materials*, 15, pp. 309-317.
- Cui, Y. & Yoon, N., (2003). Surface modification of PET with ethoxylated hexylaminoanthraquinones by exhaustion method, *Dyes and Pigments*, 58, pp. 121-125.
- Dawidczyk, T.J, Walton, M.D, Jang, W, & Grunlan, J.C. (2008). Layer-by-layer assembly of UV-resistant poly(3,4-ethylenedioxythiophene) thin films. *Langmuir*, 24, 15, AUG 5, pp. 8314-8318, ISSN 0743-7463.
- Decher, G. (2003). Polyelectrolyte multilayers, an overview. In: *Multilayer Thin Films – Sequential Assembly of Nanocomposite Materials*, G. Decher and J. B. Schlenoff., Wiley-VCH Weinheim, Germany.

- Dvoracek, CM, Sukhonosova, G, Benedik, MJ, & Grunlan, JC. (2009). Antimicrobial behavior of polyelectrolyte-surfactant thin film assemblies. *Langmuir*, 25, 17, SEP 1, pp. 10322-10328, ISSN 0743-7463
- Elices, M., Llorca, J. (2002) *Fiber Fracture*. Elsevier Science Ltd., Oxford.
- Farrow, G, Ravens, DAS, & Ward, IM. (1962). The degradation of polyethylene terephthalate by methylamine - a study by infra-red and X-ray methods. *Polymer*, 3, 1, pp. 17-25, ISSN 0032-3861.
- Ferguson, GS, & et al. (1993). Monolayers on disordered substrates - self-assembly of alkyltrichlorosilanes on surface-modified polyethylene and poly(dimethylsiloxane). *Macromolecules*, 26, 22, pp. 5870.
- Fischer-Colbrie, G. et al. (2006). Surface modification of polyacrylonitrile with nitrile hydratase and amidase from *Agrobacterium tumefaciens*. *Biocatalysis and Biotransformation*, Vol. 24, No. 4, (January 2006), pp. 419-425, ISSN 1024-2422
- Fischer-Colbrie, G. et al. (2007). Surface hydrolysis of polyacrylonitrile with nitrile hydrolysing enzymes from *Micrococcus luteus* BST20. *Journal of Biotechnology*, Vol. 129, No. 1, (March 2007), pp. 62-68, ISSN 0168-1656
- Fourne, F. (1999) *Synthetic Fibers*. Hanser Publishers, Munich.
- Franz, G. (2003) *Ullmann's Encyclopedia of Industrial Chemistry*, Vol. 13, Wiley-VCH, Weinheim.
- Frew, JE, Jones, P, & Scholes, G. (1983). Spectrophotometric determination of hydrogen-peroxide and organic hydroperoxides at low concentrations in aqueous-solution. *Analytica Chimica Acta*, 155, DEC, pp. 139-150, ISSN 0003-2670.
- Fu, JH, Ji, J, Yuan, WY, & Shen, JC. (2005). Construction of anti-adhesive and antibacterial multilayer films via layer-by-layer assembly of heparin and chitosan. *Biomaterials*, 26, 33, NOV, pp. 6684-6692, ISSN 0142-9612
- Froehling, P.E., (2001) Dendrimers and dyes - a review, *Dyes and Pigments*, 3, pp. 187-195.
- Fu, J, Ji, J, Fan, D, & Shen, J. (2006). Construction of antibacterial multilayer films containing nanosilver via layer-by-layer assembly of heparin and chitosan-silver ions complex. *Journal of Biomedical Materials Research Part a*, 79A, 3, DEC 1, pp. 665-674, ISSN 1549-3296.
- Fujimoto, K, Takebayashi, Y, Inoue, H, & Ikada, Y. (1993). Ozone-induced graft-polymerization onto polymer surface. *Journal of Polymer Science Part A-Polymer Chemistry*, 31, 4, MAR 30, pp. 1035-1043, ISSN 0887-624X.
- Gao, S. L., Häßler, R., Mäder, E., Bahners, T., Opwis, K. & Schollmeyer, E. (2005). Photochemical surface modification of PET by excimer UV lamp irradiation, *Applied Physics B: Lasers and Optics*, 81, pp. 681-690.
- Garrod, RP, Harris, LG, Schofield, WCE, McGettrick, J, Ward, LJ, Teare, DOH, & Badyal, JPS. (2007)). Mimicking a stenocara beetle's back for microcondensation using plasmachemical patterned superhydrophobic-superhydrophilic surfaces. *Langmuir*, 23, 2, JAN 16, pp. 689-693, ISSN 0743-7463.
- Geoghegan, M. & Krausch, G., (2003) Wetting at polymer surfaces and interfaces, *Progress in Polymer Science* 28, pp. 261-302.
- Gomes, J.I.N.R. & Baptista, A.L.F., (2001). Microencapsulation of acid dyes in mixed lecithin/surfactant liposomic structures, *Textile Research Journal*, 2, pp. 153-156.

- Grunlan, J.C. (2011). LBL deposition for hydrophilic surface modification of polyolefins, *Personal Communication*.
- Gu, H, Wu, J, & Doan, H. (2009). Hydrophilicity enhancement of high-density polyethylene film by ozonation. *Chemical Engineering & Technology*, 32, 5, MAY, 726-731, ISSN 0930-7516.
- Gubitz, G.M., & Cavaco-Paulo, A. (2008). Enzymes go big: surface hydrolysis and functionalisation of synthetic polymers Review Article. *Trends in Biotechnology*, Vol. 26, No. 1, (January 2008), pp. 32-38, ISSN 0167-7799
- Hebeish, A, Shalaby, SE, & Bayazeed, AM. (1979). Dyeing properties of poly(methyl vinyl pyridine) poly(ethylene terephthalate) graft-copolymers. *Journal of Applied Polymer Science*, 23, 10, pp. 3051-3059, ISSN 0021-8995.
- Heumann, S. et al. (2006). New model substrates for enzymes hydrolyzing polyethylene terephthalate and polyamide fibers. *Journal of Biochemical and Biophysical Methods*, Vol. 69, No. 1-2, (November 2006), pp. 89-99, ISSN 0165-022X
- Hillborg, H, & et al. (2000). Crosslinked polydimethylsiloxane exposed to oxygen plasma studied by neutron reflectometry and other surface specific techniques. *Polymer*, 41, 18, pp. 6851.
- Hillborg, H, & Gedde UW. (1999). Hydrophobicity changes in silicone rubbers. *Ieee Transactions on Dielectrics and Electrical Insulation*, 6, 5, pp. 703.
- Hiller, J, Mendelsohn, JD, & Rubner, MF. (2002). Reversibly erasable nanoporous anti-reflection coatings from polyelectrolyte multilayers. *Nature Materials*, 1, 1, SEP, pp. 59-63, ISSN 1476-1122.
- Hoigne, J, & Bader, H. (1976). Role of hydroxyl radical reactions in ozonation processes in aqueous-solutions. *Water Research*, 10, 5, pp. 377-386, ISSN 0043-1354.
- Hou, A., Chen, S. & Zhou, Y. (2009) Self-assembly of the polysiloxane modified with cationic and perfluorocarbon groups on the polyester surface and its effect on the color shade of the dyed polyester, *Journal of Polymer Research*, 16, pp. 687-692.
- Hsieh, YL, & Chen, EY. (1985). Improvement of hydrophilicity of poly(ethylene-terephthalate) by non-polymer-forming gaseous glow-discharge. *Industrial & Engineering Chemistry Product Research and Development*, 24, 2, pp. 246-252, ISSN 0196-4321.
- INDA (2008). Worldwide Outlook for the Nonwovens Industry 2007-2012. *Association of the Nonwovens Fabrics Industry*
- Ismail, F., et. al., (2011). Strength of interactions between immobilized dye molecules and sol-gel matrices. *Analyst*, Vol. 136, No. 4, pp. 807-815, (February 2011) month and year of the edition), ISSN 0003-2654
- Jain, S., Chattopadhyay, S., Jackeray, R. & Singh, H., (2009). Surface modification of polyacrylonitrile fiber for immobilization of antibodies and detection of analyte, *Analytica Chimica Acta*, 654, pp. 103-110.
- Jang, WS, & Grunlan, J.C. (2005). Robotic dipping system for layer-by-layer assembly of multifunctional thin films. *Review of Scientific Instruments*, 76, 10, OCT, pp. 103904, ISSN 0034-6748.

- Jawahar, P., Gnanamoorthy, R. & Balasubramanian, M. (2005) Flexural and tribological properties of polyester-clay nanocomposites, *Journal of Material Science* 40, pp. 4391 – 4393.
- Kan, C. W. (2008a) Impact on textile properties of polyester with laser, *Optics & Laser Technology*, 40, pp. 113-119.
- Kan, C. W. (2008b) A study of laser treatment on polyester substrates, *Fibers and Polymers*, 9, pp. 166-170.
- Khatibzadeh, M., Mohseni, M., Moradian, S., (2010) Compounding fibre grade polyethylene terephthalate with a hyperbranched additive and studying its dyeability with a disperse dye, *Coloration Technology*, 5, pp. 269-274.
- Kikic, I. & Vecchione, F. (2003) Supercritical impregnation of polymers, *Current Opinion in Solid State and Materials Science*, 7, pp. 399-405
- Kim, E.S., Lee, C.H. & Kim, S.H. (2009) Effects of pretreatment reagents on the hydrolysis and physical properties of PET fabrics, *Journal of Applied Polymer Science*, 112, pp. 3071-3078.
- Kim, H. & Bae, J. S. (2009). Modification of polypropylene fibers by electron beam irradiation. I. Evaluation of dyeing properties using cationic dyes, *Fibers and Polymers*, 10, pp. 320-324.
- Kim, KJ, & Ko, SW. (1989). Degradation mechanism and morphological change of pet by peg-diamine. *Journal of Applied Polymer Science*, 37, 10, MAY 20, pp. 2855-2871, ISSN 0021-8995.
- Kirk-Othmer. (1998) *Encyclopedia of Chemical Technology*, Vol. 8, Wiley-VCH, New York.
- Kiumarsi A., Parvinzadeh M. (2010). Enzymatic Hydrolysis of Nylon 6 Fiber Using Lipolytic Enzyme. *Journal of Applied Polymer Science*, Vol. 16, No. 6, (June 2010), pp. 3140-3147, ISSN 1097-4628
- Knittel, D & Schollmeyer, E. (2008) Functional group analysis on oxidized surfaces of synthetic textile polymers, *Talanta*, 76, pp. 1136-1140.
- Knittel, D. & Schollmeyer, E., (1998). Surface structuring of synthetic polymers by UV-laser irradiation. Part IV. Applications of excimer laser induced surface modification of textile materials, *Polymer International*, 45, pp. 110-117.
- Ko, YG, Kim, YH, Park, KD, Lee, HJ, Lee, WK, Park, HD, Kim, SH, Lee, GS, & Ahn, DJ. (2001). Immobilization of poly(ethylene glycol) or its sulfonate onto polymer surfaces by ozone oxidation. *Biomaterials*, 22, 15, AUG, pp. 2115-2123, 0142-9612.
- Kokatnur, VR, & Jelling, M. (1941). Iodometric determination of peroxygen in organic compounds. *Journal of the American Chemical Society*, 63, 5, 05/01, pp. 1432-1433, ISSN 0002-7863.
- Konovalova, M. V. & Rabaeva, Y. M., (2007). Surface modification and dyeing of polyester fibers using magnetically activated aqueous solutions, *Fiber Chemistry*, 39, pp. 318-321.
- Kulik, EA, Ivanchenko, MI, Kato, K, Sano, S, & Ikada, Y. (1995). Peroxide generation and decomposition on polymer surface. *Journal of Polymer Science Part A-Polymer Chemistry*, 33, 2, JAN 30, pp. 323-330, ISSN 0887-624X.

- Lee, M, Lee, MS, Wakida, T, Tokuyama, T, Inoue, G, Ishida, S, Itazu, T, & Miyaji, Y. (2006). Chemical modification of nylon 6 and polyester fabrics by ozone-gas treatment. *Journal of Applied Polymer Science*, 100, 2, APR 15, 1344-1348, ISSN 0021-8995
- Lee, MS, Lee, M, Wakida, T, Saito, M, Yamashiro, T, Nishi, K, Inoue, G, & Ishida, S. (2007). Ozone-gas treatment of cationic dyeable polyester and poly(butylene terephthalate) fibers. *Journal of Applied Polymer Science*, 104, 4, MAY 15, pp. 2423-2429, ISSN 0021-8995.
- Leszczyńska, A., Njuguna, J., Pielichowski, K., Banerjee, J.R. (2007a). Polymer/montmorillonite nanocomposites with improved thermal properties. Part I. Factors influencing thermal stability and mechanisms of thermal stability improvement, *Thermochimica Acta* 453, pp. 75 - 96.
- Leszczyńska, A., Njuguna, J., Pielichowski, K., Banerjee, J.R. (2007b). Polymer/montmorillonite nanocomposites with improved thermal properties. Part II. Thermal stability of montmorillonite nanocomposites based on different polymeric matrixes, *Thermochimica Acta* 454, pp. 1 - 22.
- Lewin, M. (2007). *Handbook of Fiber Chemistry*, CRC Press FL, USA.
- Li, Y, Mannen, S, Schulz, J, & Grunlan, JC. (2011). Growth and fire protection behavior of POSS-based multilayer thin films. *Journal of Materials Chemistry*, 21, 9, pp. 3060-3069, ISSN 0959-9428.
- Li, Y, Schulz, J, Mannen, S, Delhom, C, Condon, B, Chang, S, Zammarano, M, & Grunlan, JC. (2010). Flame retardant behavior of polyelectrolyte-clay thin film assemblies on cotton fabric. *ACS Nano*, 4, 6, JUN, pp. 3325-3337, ISSN 1936-0851.
- Liao, S. K., Ho, Y.C. & Chang, P.S. (2000). Dyeing of nylon 66 with a disperse-reactive dye using supercritical carbon dioxide as the transport medium, *Coloration Technology*, 12, pp. 403-407.
- Lim, HS, Han, JT, Kwak, D, Jin, M, & Cho, K. (2006). Photoreversibly switchable superhydrophobic surface with erasable and rewritable pattern. *Journal of the American Chemical Society*, 128, 45, NOV 15, pp. 14458-14459, ISSN 0002-7863.
- Li-qiu, Y., Shu-fen, Z, Liang, H.E, Wei, M.A. & Jin-zong, Y. (2005) The dyeing of polypropylene fibers in supercritical fluid, *The Proceedings of the 3rd International Conference on Functional Molecules*, Dalian, China, September 2005.
- Ma, J., Xu, J., Ren, J.H., Yu, Z.Z. & Mai, Y.W., (2003) A new approach to polymer/montmorillonite nanocomposites, *Polymer*, 44, pp. 4619 - 4624.
- Mahltig, B.; Textor, T. (2008). *Nanosols And Textiles*, World Scientific Publishing Company ISBN: 9812833501, New Jercey, USA
- Mallick, B., Behera, R. C. & Patel, T., (2005). Analysis of microstress in neutron irradiated polyester fiber by X-ray diffraction technique, *Bulletin of Materials Science*, 28, pp. 593-598.
- Marc,al, L., et. al., (2011). Amine-Functionalized Titanosilicates Prepared by the Sol-Gel Process as Adsorbents of the Azo-Dye Orange II. *Industrial Engineering Chemistry Research*, Vol. 50, No. 1, pp. 239-246, (January 2011), ISSN 0888-5885
- Marti, M., Maza, A. de la, Parra, J.L. & Coderch, L., (2011). Liposome as dispersing agent into disperse dye formulation, *Textile Research Journal*, 4, pp. 379-387

- Matama, T. et al. (2006). The effect of additives and mechanical agitation in surface modification of acrylic fibers by cutinase and esterase. *Biotechnology Journal*, Vol. 1, No. 7-8, (July-August 2006), pp. 842-849, ISSN 0168-1656.
- Matama, T. et al. (2007). Using a nitrilase for the surface modification of acrylic fibers. *Biotechnology Journal*, Vol. 2, No. 3, (March 2007), pp. 353-360, ISSN 0168-1656
- McIntyre, J. E. (2005) *Synthetic Fibers: Nylon, Polyester, Acrylic, Polyolefin*. Woodhead publisher, Cambridge.
- Mikhailova, O. V., Pavlov, N. N., Barantsev, V. M. & Degtyarev, S. V., (2008) Increasing the hydrophilicity of polyester fibers and fabrics by treatment with solutions of metal salts, *Fiber Chemistry*, 4, pp. 107-109.
- Minko, S. (2008). Grafting on solid surfaces: "grafting to" and grafting from" methods. In: *Polymer surfaces and interfaces: characterization, modification and applications*, editor Manfred Stamm and Manfred Stamm. , Springer 215, 9783540738640 (hbk.); 3540738649 (hbk.), Berlin ; London.
- Modesti, M., Besco, S., Lorenzetti, A., Causin, V., Marega, C., Gilman, J.W., Fox, D.M., Trulove, P.C., De Long, H.C. & Zammarano, M., (2007) ABS/clay nanocomposites obtained by a solution technique: Influence of clay organic modifiers, *Polymer Degradation & Stability* 92, pp. 2206 - 2213.
- Nedelčev, T., et. al., (2008). The leaching of Rhodamine B, Naphthol Blue Black, Metanil Yellow and Bismarck Brown R from silica deposits on polyester and viscose textiles. *Journal of Sol-Gel Science and Technology*, Vol. 46, No. 1, pp. 47-56, (April 2008), ISSN 0928-0707
- Nissen, KE, Stevens, MG, Stuart, BH, & Baker, AT. (2001). Characterization of PET films modified by tetraethylenepentamine (TTEPA). *Journal of Polymer Science Part B- Polymer Physics*, 39, 6, MAR 15, pp. 623-633, ISSN 0887-6266.
- Nitschke, M. (2008). Plasma modification of polymer surfaces and plasma polymerization. In: *Polymer surfaces and interfaces : characterization, modification and applications*, editor Manfred Stamm and Manfred Stamm. , Springer 203, 9783540738640 (hbk.); 3540738649 (hbk.), Berlin ; London.
- Njuguna, J., Pielichowski, K. & Desai, S. (2008). Nanofiller-reinforced polymer nanocomposites, *Polymers for Advanced Technologies*, 19, pp. 947 - 959.
- Ondogan, Z., Pamuk, O., Ondogan, E. N. & Ozguney, A. (2005). Improving the appearance of all textile products from clothing to home textile using laser technology, *Optics & Laser Technology*, 37, pp. 631-637.
- Owen, MJ. (2005). Plasma/Corona treatment of silicones. *Australian Journal of Chemistry*, 58, pp. 433.
- Owen, MJ, & Smith, P. (1994). Plasma treatment of polydimethylsiloxane. *Journal of Adhesion Science and Technology*, 8, 10, pp. 1063.
- Owens, DK. (1975). Mechanism of corona and ultraviolet light-induced selfadhesion of poly(ethylene terephthalate) film. *Journal of Applied Polymer Science*, 19, 12, pp. 3315-3326, ISSN 0021-8995.
- Palmer, T. & Bonner, P.L. (2007). *Enzymes; biochemistry, biotechnology and clinical chemistry*, Horwood Publishing, ISBN 1904275273, Chichester, UK

- Park, J. H., Kim, B. S., Tae, H. J., Kim, I. S., Kim, H. Y. & Khi, M. S., (2009). Polyelectrolyte multilayer coated nanofibrous mats: Controlled surface morphology and cell culture, *Fibers and Polymers*, 10, pp. 419-424.
- Park, YT, Ham, AY, & Grunlan, JC. (2011). Heating and acid doping thin film carbon nanotube assemblies for high transparency and low sheet resistance. *Journal of Materials Chemistry*, 21, 2, pp. 363-368, ISSN 0959-9428.
- Parvinzadeh M. (2009). A new approach to improve dyeability of nylon 6 fibre using a subtilisin enzyme. *Coloration Technology*, Vol. 125, No. 2, (April 2009), pp. 228-233, ISSN 1472-3581
- Parvinzadeh, M. & Eslami, S., (2011) Optical and electromagnetic characteristics of clay-iron oxide nanocomposites, *Research on Chemical Intermediates*, Vol. 37, pp. 771-784.
- Parvinzadeh, M. et al., (2009). Biohydrolysis of nylon 6,6 fiber with different proteolytic enzymes. *Polymer Degradation and Stability*, Vol. 94, No. 8, (August 2009), pp. 1197-1205. ISSN 0141-3910
- Parvinzadeh, M, & Ebrahimi, I. (2011). Atmospheric air-plasma treatment of polyester fiber to improve the performance of nanoemulsion silicone. *Applied Surface Science*, 257, 9, FEB 15, pp. 4062-4068, ISSN 0169-4332.
- Parvinzadeh, M., et al. (2010b) Surface characterization of polyethylene terephthalate/silica nanocomposites, *Applied Surface Science*, 256, pp. 2792 - 2802.
- Parvinzadeh, M., et. al. (2010a) Effect of the addition of modified nanoclays on the surface properties of the resultant polyethylene terephthalate/clay nanocomposites, *Polymer-Plastics Technology and Engineering*, 49, pp. 874 - 884, 2010
- Pavlov, N. N., Barantsev, V. M., Degtyarev, S. V., Anikin, V. A., Balabanova, L. V. & Pavlova, V. V., (2001). Complex metal cations as modifiers of the properties of polyester Fibers, *Fiber Chemistry*, 33, pp. 455-458.
- Pesetskii, S.S., Bogdanovich, S.P., Myshkin, N.K., (2007). Tribological behavior of nanocomposites produced by the dispersion of nanofillers in polymer melts, *Journal of Friction and Wear* 28, pp. 457 - 475.
- Phang, Y., Pramoda, K.P., Liu, T. & He, C. (2004) Crystallization and melting behavior of polyester/clay nanocomposites, *Polymer International* 53, pp. 1282 - 1289.
- Podhajny, R. (1987). Corona treatment of polymeric films. *Journal of Plastic Film & Sheeting*, 4, pp. 177.
- Priolo, MA, Gamboa, D, & Grunlan, JC. (2010). Transparent clay-polymer nano brick wall assemblies with tailorable oxygen barrier. *Acs Applied Materials & Interfaces*, 2, 1, JAN, pp. 312-320, ISSN 1944-8244.
- Priolo, MA, Gamboa, D, Holder, KM, & Grunlan, JC. (2010). Super gas barrier of transparent polymer-clay multi layer ultrathin films. *Nano Letters*, 10, 12, DEC, pp. 4970-4974, ISSN 1530-6984.
- Prorokova, N. P. & Vavilova, S. Y., (2004) The modifying effect of ammonium nitrate and sodium hydroxide on poly(ethylene terephthalate) materials, *Fiber Chemistry*, 36, pp. 413-415.
- Prorokova, N. P., Kumeeva, T. Y., Zavadskii, A. E. & Nikitin, L. N. (2009). Modification of the surface of poly(ethylene terephthalate) fabrics by application of a water-

- repellent coating in supercritical carbon dioxide medium, *Fiber Chemistry*, 41, pp. 29-33
- Prorokova, N. P., Khorev, A. V. & Vavilova, S. Y. (2009). Chemical method of surface activation of poly(ethylene terephthalate) fibre materials Part 1. Study of the modifying effect of sodium hydroxide solutions and products made from quaternary ammonium salts, *Fiber Chemistry*, 41, pp. 158-163.
- Razafimahefa, L., Chlebicki, S., Vroman, I., Devaux, E., (2005) Effect of nanoclay on the dyeing ability of PA6 nanocomposite fibers, *Dyes and Pigments*, 1, pp. 55-60.
- Shalaby, SE, Allam, E, Abouzeid, NY, & Bayzeed, AM. (1976). Graft copolymerization of 2-methyl-5-vinylpyridine onto poly(ethylene-terephthalate) fibers. *Journal of Applied Polymer Science*, 20, 9, pp. 2565-2568, ISSN 0021-8995.
- Shalaby, SE, Bayzeed, AM, & Hebeish, A. (1978). Factors affecting polymerization of 2-methyl-5-vinylpyridine in poly(ethylene-terephthalate) fibers using benzoyl peroxide as initiator. *Journal of Applied Polymer Science*, 22, 5, pp. 1359-1375, ISSN 0021-8995.
- Shaohua, L., Xiang, Z., Tianmin, T., Zhiqi, X. & Qihong, L. (2003). UV-laser treatment of PET fabrics: changes in fiber structure and dyeing behaviour, *Coloration Technology*, 119, pp. 19-23.
- Shcherbina, N. A., Bychkova, E. V. & Panova, L. G., (2008). Modification of polyacrylonitrile fiber to reduce combustibility, *Fiber Chemistry*, 40, pp. 506-509.
- Shim, J.J., Choi, J.H., Ju, J.H., Son, B.K., Ahn, J.M., Kim, B.H. & Kim, K. S., (2003) Dyeing of polyester, aramid and polypropylene fibers in supercritical CO₂, *The 6th ISSF*, Versailles.
- Sinha Ray, S. & Okamoto, M. (2003) Polymer/layered silicate nanocomposites: a review from preparation to processing, *Progress in Polymer Science*, 28, pp. 1539 - 1641.
- Sohn, S. O., Lee, S.M., Kim, Y.M., Yeum, J.H., Choi, J.H. & Ghim, H.D. (2007) Aroma finishing of PET fabrics with PVAc nanoparticles containing lavender oil, *Fibers and Polymers*, 8, pp. 163-167.
- Stakne, K., Smole, M. S., Kleinschek, K. S., Jaroschuk, A. & Ribitsch, V., (2003) Characterization of modified polypropylene fibers, *Journal of Materials Science*, 38, pp. 2167-2169.
- Sun, W, Shen, L, Wang, L, Fu, K, & Ji, J. (2010). Netlike knitting of polyelectrolyte multi layers on honeycomb-patterned substrate. *Langmuir*, 26, 17, SEP 7, pp. 14236-14240, ISSN 0743-7463.
- Suzuki, M, Kishida, A, Iwata, H, & Ikada, Y. (1986). Graft-copolymerization of acrylamide onto a polyethylene surface pretreated with a glow-discharge. *Macromolecules*, 19, 7, JUL, pp. 1804-1808, ISSN 0024-9297.
- Tauber, M.M. et al., (2000). Nitrile hydratase and amidase from *Rhodococcus rhodochrous* hydrolyse acrylic fibers and granulates. *Applied and Environmental Microbiology*, Vol. 66, No. 4, (April 2000), pp. 1634-1638, ISSN 0099- 2240
- Textor, T., Bahners, T. & Schollmeyer, E., (2003). Modern approaches for intelligent surface modification, *Journal of Industrial Textiles*, 32, pp. 279-289.
- Tomasino, C. (1992). *Chemistry and Technology of Fabric Preparation and Finishing*, North Carolina State Univ. Press, North Carolina, USA.

- Toshniwal, L., Fan, Q., Ugbolue, S.C., (2007) Dyeable polypropylene fibers via nanotechnology, *Journal of Applied Polymer Science*, 1, pp. 706-711.
- Veronovski, N., Rudolf, A., Smole, M.S., Kreže, T. & Geršak, J. (2009). Self-cleaning and handle properties of TiO₂-modified textiles, *Fibers and Polymers*, 10, pp. 551-556.
- Vertommen, M.A.M.E. et al., (2005). Enzymatic surface modification of poly(ethylene terephthalate). *Journal of Biotechnology*, Vol. 120, No. 4, (December 2005), pp. 376-386, ISSN 0168-1656
- Wakida, T., Lee, M., Jeon, J. H., Tokuyama, T., Kuriyama, H., & Ishida, S. (2004). Ozone-gas treatment of wool and silk fabrics. *Sen-i Gakkaishi*, 60(7), 213-219.
- Wang, N. et al., (2004). Enzymatic surface modification of acrylic fiber. *AATCC Review*, Vol. 4, (April 2004), pp. 28-30, ISSN 1532-8813
- Valk, G, Kehren, ML, & Daamen, I. (1970). Photooxidation of polyethyleneglycol terephthalate fibers. *Angewandte Makromolekulare Chemie*, 13, pp.97-&, ISSN 0003-3146.
- Wakida, T, Lee, M, Jeon, JH, Tokuyama, T, Kuriyama, H, & Ishida, S. (2004). Ozone-gas treatment of wool and silk fabrics. *Sen-i Gakkaishi*, 60, 7, JUL, pp. 213-219, ISSN 0037-9875.
- Watanabe, H. & Takata, T., (1996). Surface modification of synthetic fibers by excimer laser irradiation, *Die Angewandte Makromolekulare Chemie*, 235, pp. 95 - 110.
- Wei, Q. F, Yu, L., Wu, N. & Hong, S. (2008) Preparation and characterization of copper nanocomposite textiles, *Journal of Industrial Textiles*, 37, pp. 275-283.
- Yang, Y., Haile, M., Park, Y. T., Malek, F. A., & Grunlan, J. C. (2011). Super gas barrier of all-polymer multilayer thin films. *Macromolecules*, 44(6), 1450-1459. doi:10.1021/ma1026127
- Wei, Q. F., Xu, W. Z., Ye, H. & Huang, F. L. (2006) Surface functionalization of polymer fibers by sputter coating, *Journal of Industrial Textiles*, 35, pp. 287-294.
- Xanthos, M. (2005) *Functional Fillers for Plastics*, Wiley, Weinheim.
- Xiao, W., Yu, H., Han, K. & Yu, M. (2005) Study on PET fiber modified by nanomaterials: improvement of dimensional thermal stability of PET fiber by forming PET/MMT nanocomposites, *Journal of Applied Polymer Science* 96, pp. 2247 - 2252.
- Yan, L., Yi, Z., Ben, Z., Juan, D. & Shuilin, C., (2011) Effect of microencapsulation on dyeing behaviors of disperse dyes without auxiliary solubilization, *Journal of Applied Polymer Science*, 1, pp. 484-491.
- Yang, Y., Gu, H., (2007) Preparation and properties of deep dye fibers from poly(ethylene terephthalate)/SiO₂ nanocomposites by in situ polymerization, *Journal of Applied Polymer Science*, 4, pp. 2363-2369,
- Yang, Y, Haile, M, Park, YT, Malek, FA, & Grunlan, JC. (2011). Super gas barrier of all-polymer multilayer thin films. *Macromolecules*, 44, 6, MAR 22, pp. 1450-1459, ISSN 0024-9297.
- Yip, J., Chan, K., Sina, K. M & Laub, K. S. (2002). Study of physico-chemical surface treatments on dyeing properties of polyamides. Part 2: Effect of UV excimer laser irradiation, *Coloration Technology*, 118, pp. 31-34.

- Zenerino, A, Darmanin, T, de Givenchy, ET, Amigoni, S, & Guittard, F. (2010). Connector ability to design superhydrophobic and oleophobic surfaces from conducting polymers. *Langmuir*, 26, 16, AUG 17, pp. 13545-13549, 0743-7463.
- Zhai, L, Berg, M, Cebeci, F, Kim, Y, Milwid, J, Rubner, M, & Cohen, R. (2006). Patterned superhydrophobic surfaces: Toward a synthetic mimic of the namib desert beetle. *Nano Letters*, 6, 6, JUN, pp. 1213-1217, 1530-6984.
- Zhang, D, Sun, Q, & Wadsworth, LC. (1998). Mechanism of corona treatment on polyolefin films. *Polymer Engineering and Science*, 38, 6, JUN, pp. 965-970, 0032-3888.
- Zhu, Z., Kelley M. J. (2004). Poly(ethylene terephthalate) surface modification by deep UV (172 nm) irradiation, *Applied Surface Science*, 236, pp. 416-425.

IntechOpen



Textile Dyeing

Edited by Prof. Peter Hauser

ISBN 978-953-307-565-5

Hard cover, 392 pages

Publisher InTech

Published online 14, December, 2011

Published in print edition December, 2011

The coloration of fibers and fabrics through dyeing is an integral part of textile manufacturing. This book discusses in detail several emerging topics on textile dyeing. "Textile Dyeing" will serve as an excellent addition to the libraries of both the novice and expert.

How to reference

In order to correctly reference this scholarly work, feel free to copy and paste the following:

Mazeyar Parvinzadeh Gashti, Julie Willoughby and Pramod Agrawal (2011). Surface and Bulk Modification of Synthetic Textiles to Improve Dyeability, Textile Dyeing, Prof. Peter Hauser (Ed.), ISBN: 978-953-307-565-5, InTech, Available from: <http://www.intechopen.com/books/textile-dyeing/surface-and-bulk-modification-of-synthetic-textiles-to-improve-dyeability>

INTECH
open science | open minds

InTech Europe

University Campus STeP Ri
Slavka Krautzeka 83/A
51000 Rijeka, Croatia
Phone: +385 (51) 770 447
Fax: +385 (51) 686 166
www.intechopen.com

InTech China

Unit 405, Office Block, Hotel Equatorial Shanghai
No.65, Yan An Road (West), Shanghai, 200040, China
中国上海市延安西路65号上海国际贵都大饭店办公楼405单元
Phone: +86-21-62489820
Fax: +86-21-62489821

© 2011 The Author(s). Licensee IntechOpen. This is an open access article distributed under the terms of the [Creative Commons Attribution 3.0 License](#), which permits unrestricted use, distribution, and reproduction in any medium, provided the original work is properly cited.

IntechOpen

IntechOpen