

We are IntechOpen, the world's leading publisher of Open Access books Built by scientists, for scientists

4,800

Open access books available

122,000

International authors and editors

135M

Downloads

Our authors are among the

154

Countries delivered to

TOP 1%

most cited scientists

12.2%

Contributors from top 500 universities



WEB OF SCIENCE™

Selection of our books indexed in the Book Citation Index
in Web of Science™ Core Collection (BKCI)

Interested in publishing with us?
Contact book.department@intechopen.com

Numbers displayed above are based on latest data collected.

For more information visit www.intechopen.com



Measuring System of Urea in Blood by Application in Recirculation for Hemodialysis Treatment

G.A. Martinez

*Department of Nephrology
Hemodialysis Subsection
Military Hospital Center
México D.F.*

1. Introduction

End stage renal disease (ESRD) is one of the most common life-threatening diseases. The number of patients accepted for renal replacement therapy including hemodialysis (HD), peritoneal dialysis, and kidney transplantation in developed and developing countries increases each year and imposes a major social and economic burden on these communities.^[1]

With an increasing number of elderly patients as well as patients with co-morbid conditions such as vascular disease and diabetes mellitus in the hemodialysis (HD) population, a well functioning mature arteriovenous fistula (AVF) is essential for the delivering HD in these patients. ^{[1],[2]} Malfunction of permanent vascular accesses remains a cause of frequent and costly morbidity among these patients. ^[3]

Stenosis of the HD vascular access is common with an occlusion rate of 17–45% at one year. ^{[4],[5]} Therefore, periodic monitoring of the access is recommended; early detection and correction of stenotic lesions can reduce the frequency of thrombosis and the need for high-risk therapy, increase the life of the access and help to reduce the rate of access failure. ^{[1],[5]}

A variety of techniques such as physical examination, venous pump pressure, percent access recirculation, transonic flow and others are helpful in detecting vascular access dysfunction and improve assessment of the vascular access site. ^{[4],[6]} There is currently no consensus as to the optimum method of screening for stenosis; the most widely used method of screening for stenosis has been the percent access recirculation (%AR) measurement. ^[4]

Vascular access recirculation (AR) is defined as the return of dialyzed blood to the arterial segment of the access bypassing the systemic recirculation, thereby resulting in reducing the efficiency of dialysis. ^[7] High degrees of recirculation can lead to a significant discrepancy between the amount of HD prescribed and the amount of HD delivered. ^[8] Some investigators have suggested that AR of 15% or higher reliably suggests significant stenosis. ^[4]

The usually method for recirculation measuring is the Doppler Effect and the different technical based in the circulation blood sense of through the needles. These procedures have the great advantage to be carried by the medical and infirmary personal.

At the moment some automatic systems estimate the recirculation rate with used hemodilución technical that consist in the administration of saline serum in the return line,

as well the employment of differences sensors in the arterial line for example; they measure of transmission the ultrasounds speed, the changes in the hematocrit conductivity or the temperature in blood.

The investment of lines also produces changes in the increases of the hematocrit induced by abrupt increments of the ultra filtration rate, constituting the base of our procedure to measure the flow of the vascular access.

There are hemodialysis monitors that incorporate the automatic reading of the ionic dialisance by conductivity analysis in the dialysis liquid. This measuring is effectuated to input and output in the dialysis filter. The ionic dialisance is equivalent to urea clearing (clearing of the dialyzed corrected by the total recirculation) that variation in the ionic dialisance is depends on the flow in the vascular access and it allows the calculation of the same one without having to dilute the blood by the administration of saline serum.

At the moment some automatic systems estimate the recirculation rate with used hemodilución technical that consist in saline serum administration, as well the employment of differences sensors (ultrasounds, conductivity or the temperature) in the arterial line.

Example of the previous things is that some hemodialysis monitors that incorporate the automatic reading based of the ionic dialisance and conductivity analysis in the dialysis liquid.

This measuring is effectuated to input and output in the dialysis filter. The ionic dialisance is equivalent to urea clearing (clearing of the dialyzed corrected by the total recirculation) that variation in the ionic dialisance is depends on the flow in the vascular access and it allows the calculation of the same one without having to dilute the blood by the administration of saline serum.

We are studying the possibility to recirculation measure in fixed and permanent vascular access by On-Line mensuration of the Urea in blood (BUN) by employ the optical sensor in visible range, this results which compare by laboratory technical based in the method recirculation of two needles.

The purpose of the present study was to evaluate AR in chronic renal failure patients for early detection of access stenosis and subsequent intervention or revision to prolong the life of the access.

It is well established that one of cause of inadequate dialysis in HD patients is arterio-venous (A-V) fistula access recirculation (AR). Hemodialysis AR is diagnosed when dialyzed blood returning through the venous side reenters the dialyzer through the arterial needle, rather than returning to the systemic circulation and as a result, the efficiency of HD is reduced.⁽⁸⁾ Thus the aim of the study was to investigate the prevalence and causes of A-V fistula recirculation in HD patients in Military Hospital Center in Mexico City.

2. Material and methods

From February 2008 to August 2009, this cross sectional study was conducted on adult ESRD (End-stage Renal Disease) patients in HD of Military Hospital Center, Mexico City. A standardized questionnaire was used to collect demographic data, cause of ESRD, the date of HD onset, the type of access for HD, the date of creation and use of A-V fistula and history of a kidney transplant.

The ESRD was defined as permanent and irreversible loss of renal function requiring renal replacement therapy. They were included in the work all the patients in the Hemodialysis program in the Military Hospital Centre.

The study was practice in 37 patient's 15 males and 22 women, with ages 14 and 59 years and the time in hemodialysis treatment between 1 month and 4 years. Mean age of patients was 54.7 ± 15 years, male 55.9 ± 15.2 years and female 52.9 ± 14.7 years. Causes of ESRD of our patients included high blood pressure, diabetes mellitus, glomeronephritis, obstructive uropathy, polycystic kidney and other causes.

HD was performed for 3-4 Hrs, three times a week, using synthetic (polysulfone) dialyzer membranes, and bicarbonate-based dialysate at a delivered bicarbonate concentration of 35 mEq/L. Blood flow rate was maintained at 250-350 mL/min, and the dialysate flow rate at 500 mL/min. Then the degree of recirculation was measured with Urea based two needle method from the following formula (9):

2.1 Two needles technique

The analytic form in the recirculation access is based in the urea molecule mensuration or BUN (Nitrogenous Urea in Blood) this estimation is quantified by in employment of the following formulates.

$$R = \frac{(S - A)}{(S - V)} \times 100\% \quad (1)$$

Where;

S: Urea concentration in blood to take in Peripheral line a low fluid.

A: Urea Concentration in blood to take in arterial line a constant fluid.

V: Urea Concentration in blood to take in venous line a constant fluid.

Arterial (A) and Venus (V) samples to same time and Peripheral (P) obtained with the slow-stop-flow method; obtained A and V; the flow in peristaltic bomb to decrease at 50 ml/min, exactly 10 seconds. Then stop the bomb and immediately clamp the arterial line above the place samples extraction one the sample of blood S or systemic. Then the dialysis is restarted. It is the denominated method of the two needles. To make these determinations recommending 5 to 30 minutes of initiate the dialysis.

The following protocol was used for blood sampling.

1. The ultrafiltration was turned off approximately 30 minutes after the initiation of HD and then arterial and venous line samples (A and V in the above formula) were obtained.
2. Access blood flow was reduced to 50 mL/min and 15 to 30 seconds later, the systemic blood sample (P in the above formula) from the arterial blood line was obtained (two-needle" techniques).
3. The samples are reported via the laboratory and they are compared with those registered by On-Line system, we compared the statistical results the recirculation percentage and the KT/V estimate.

2.2 Online measurement system in blood urea

We arranged optical custom measurement system based on photodiodes arrays connected to a PIC16F876 microcontroller, which implemented the acquisition and the physical interface between the optical sensors and the display and computer. The system is formed by an array of 128 photodiodes (Texas Instruments); the light source is a LED diode with a single wavelength of 620 nm.

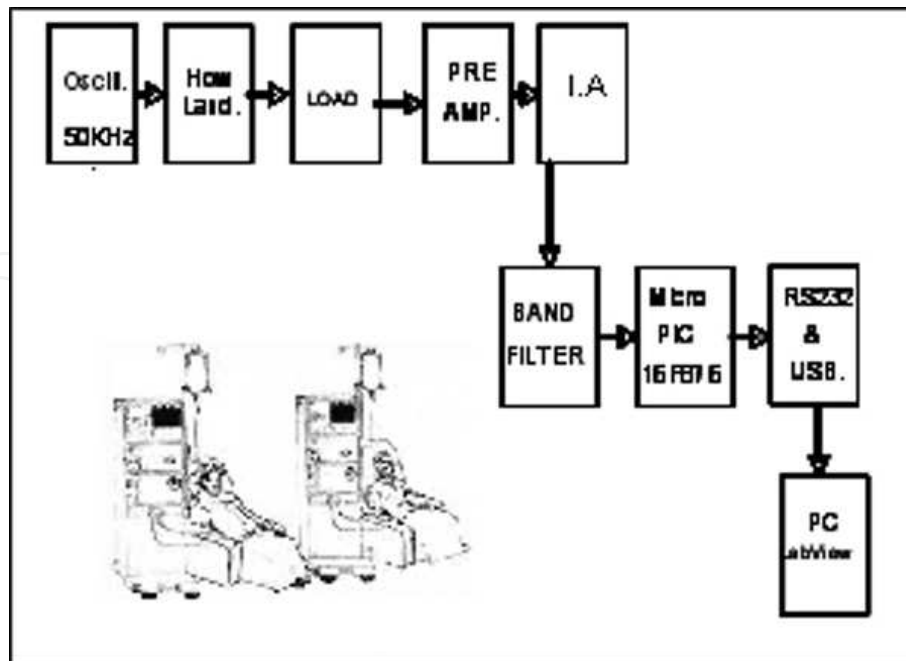

Fig. 1. Schematic diagrams the on line system for urea in blood and LabView programming to connection a PC via RS-232 Protocol used in recirculation measurement during Hemodialysis treatment.

The physical construction system consists on a small dark chamber where the source of light (LED) and the semiconductor device used as sensor (photodiode array) are placed. They are located lengthwise regarding the probe of transparent plastic through which the liquid samples are passed. The linear disposition of photodiodes gives a better rejection of stray light conduced through the tube walls. The voltage resulting of integrating the current of each photodiode during a controlled time is used as the input signal of the 10 bit microcontroller A/D converter. The captured data are then transmitted via RS-232 to a personal computer.

The user interface is developed with Visual Basic ver.6.0, and Lab view Programming performing the data graphical representation to determination the constant of the time.

A. On line Recirculación Systems

1. Oscillator: The oscillator used to generate a Sine wave, was the bridge Howland composed at four resistance and two capacitors. The configuration its low distortion and effective stabilization amplitude, used the TL081 circuit.
2. Tranconductance amplifier (OTA): Generate the current in LED (light-emitting diode), is implemented to LM3080 circuit, which has a gain control.
3. Instrumentation Amplifier (IA): AD624 instrumentation amplifier. The tension in the optical sensor (Array 128 photodiodes) adds to Voltage continuous in 1.25 V.
4. Filtered / Conditioning: The filter function is used TL081 Operational amplifiers, for passes band filter in 45-55 KHz.
5. Microcontroller: PIC16F876 microcontroller, with the internal A/D converter for Sine signal Voltage, and transmission RS-232 communication protocol.



Fig. 2. Experimental Prototype by using PIC16F8767 Microcontroller and connection in the Hemodialysis machine

B. Operation Mode

The optical system consists on a small dark chamber where the source of light (LED) and the semiconductor device used as sensor (photodiode array) are placed. They are located lengthwise regarding the probe of transparent plastic through which the liquid samples are passed. The linear disposition of photodiodes gives a better rejection of stray light conducted through the tube walls. The voltage resulting of integrating the current of each photodiode during a controlled time is used as the input signal of the 10 bit microcontroller A/D converter. The captured data are then transmitted via RS-232 to a personal computer; this data is used to calculations urea concentration. Finally the parameters they show in the graphics interface.



Fig. 3. Experimental systems with both the optical absorbance probe in patients in hemodialysis treatment.

2.3 Measure process of urea concentration in blood in laboratory technical

We used the two needles technique for the recirculation measure in the vascular access. In hemodialysis session, the flow in the vascular access is measured by employs the optical sensor for practice the on-line measure of Urea in blood and blood samples for evaluation in laboratory.

To treatment started the flow is the 400 ml/min after 30 min. We proceed to taking of samples in blood in the arterial (A) and venues (V) line in a simultaneous way, next time diminishes the flow to 50 ml/min during 30 seconds, which this proceeds to a second blood sample in the arterial line (S), concluded this activity with continues the hemodialysis session to the arterial flow prescribed.

The all measurements samples were evaluated in laboratory and on line measurement prototype for urea in hemodialysis treatment. The patients were divided into two groups, group 1 patients without recirculation and group 2 patients with recirculation.

For each patient distances between arterial and venous needles and distances of needles from A-V fistula and its directions was recorded. The findings were analyzed by SPSS statistical program. Chi square test or Fisher Exact test were used for qualitative data. For two group's quantitative data, the means were compared by using student's t test.

Association between risk factors and recirculation rate was evaluated by COX regression model. Statistical significance was assessed at the 0.05 probability level in all analyses.

3. Results

Overall, thirty SEVEN patients 15 male (40.54%) and 22 female (59.45%) were on HD therapy in our centers. From them, thirty seven patients have an A-V fistula and they were on HD more than three months that they enrolled for the study.

3.1 Experimental system

The direct results obtained with the prototype display the optical transmittance in the range of 600-620 nm, corresponding to a Red LED show the evolution in the urea concentration estimated during the experimental Hemodialysis procedure in a patient. In the Figure 4 show the recirculation evolution of the urea concentration during Hemodialysis treatment in a patient shows values in the A-V fistula.

3.2 Clinical measurements

To verify the functioning system, we comparing the urea concentration values obtained with the online prototype values versus Laboratory. Successive measurements under same conditions (connectors, power, temperature, etc.) observing a small dispersion.

The results obtained with optical system and Laboratory (Dade Behring equipment) was coherent. In the Figure 5 we can observe that statistic factor between laboratory and prototype for recirculation percentage in Permanent Vascular Access (PVA). The average estimation for recirculation percentage impermanent accesses via laboratory is $3.57 \pm 2.28 \%$, with optical system is $4.55 \pm 2.35\%$ The Figure 6 we can observe that statistic estimation for recirculation percentage in Permanent Hemodialysis Catheter (PHC)

The average accesses via laboratory is $6.25 \pm 4.16 \%$, with optical system is $8.77 \pm 5.13\%$. The show results indicate good correlation in average and standard deviation, the equal forms both measurement systems show wide dispersion The correlation coefficient between optical system and laboratory in the recirculation measurement in permanent accesses is $R^2 = 0.69$ was temporary accesses $R^2 = 0.66$

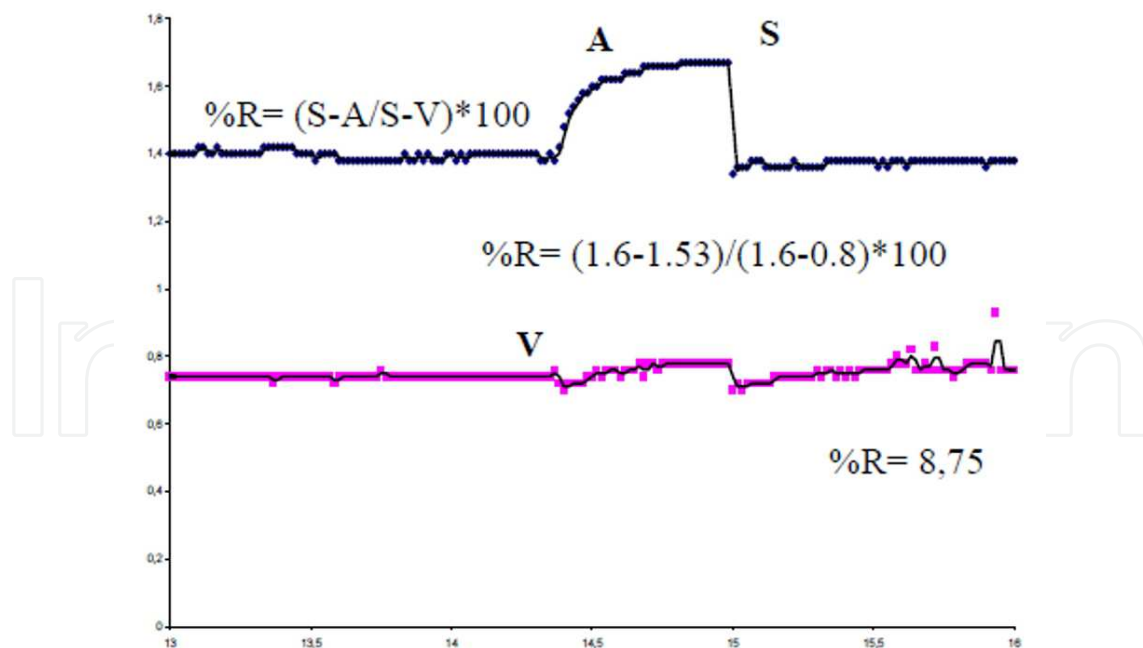

Fig. 4. Recirculation measurement by optical system, the calculation is based in the voltages estimation during Hemodialysis Treatment, Peripheral (S), Arterial (A) and Venous (v) blood samples when two needles technique.

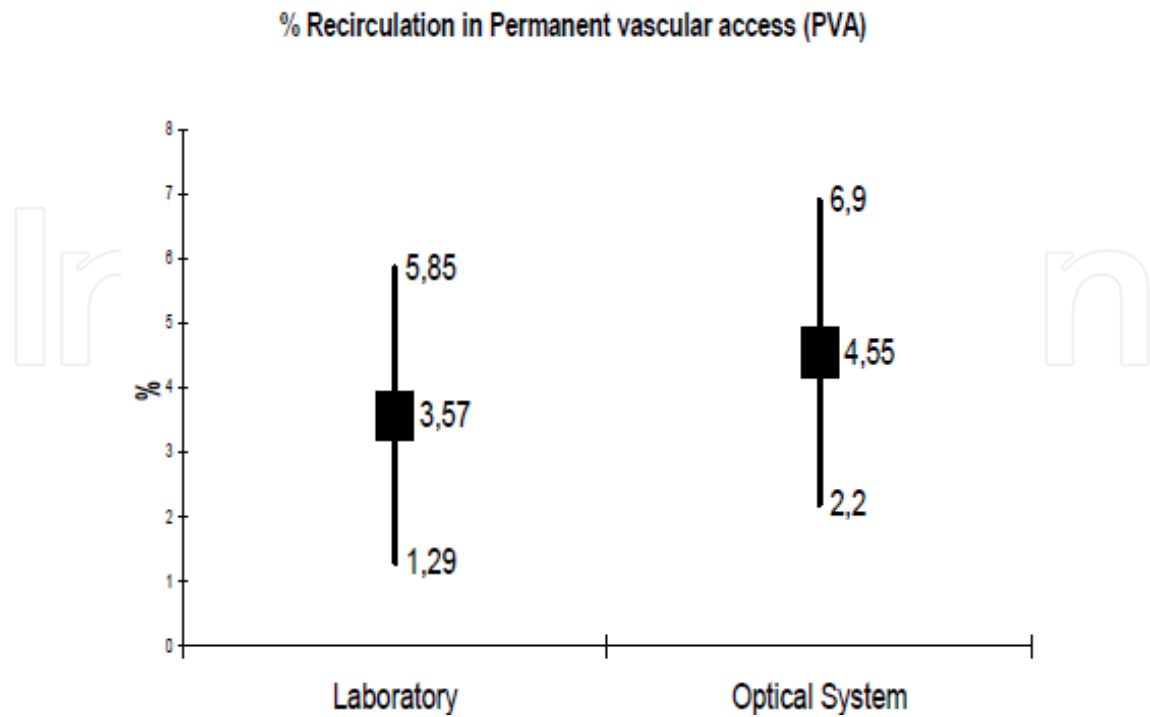

Fig. 5. Results obtained by Laboratory vs. Optical system for recirculation percentage in Permanent Vascular Access (PVA).

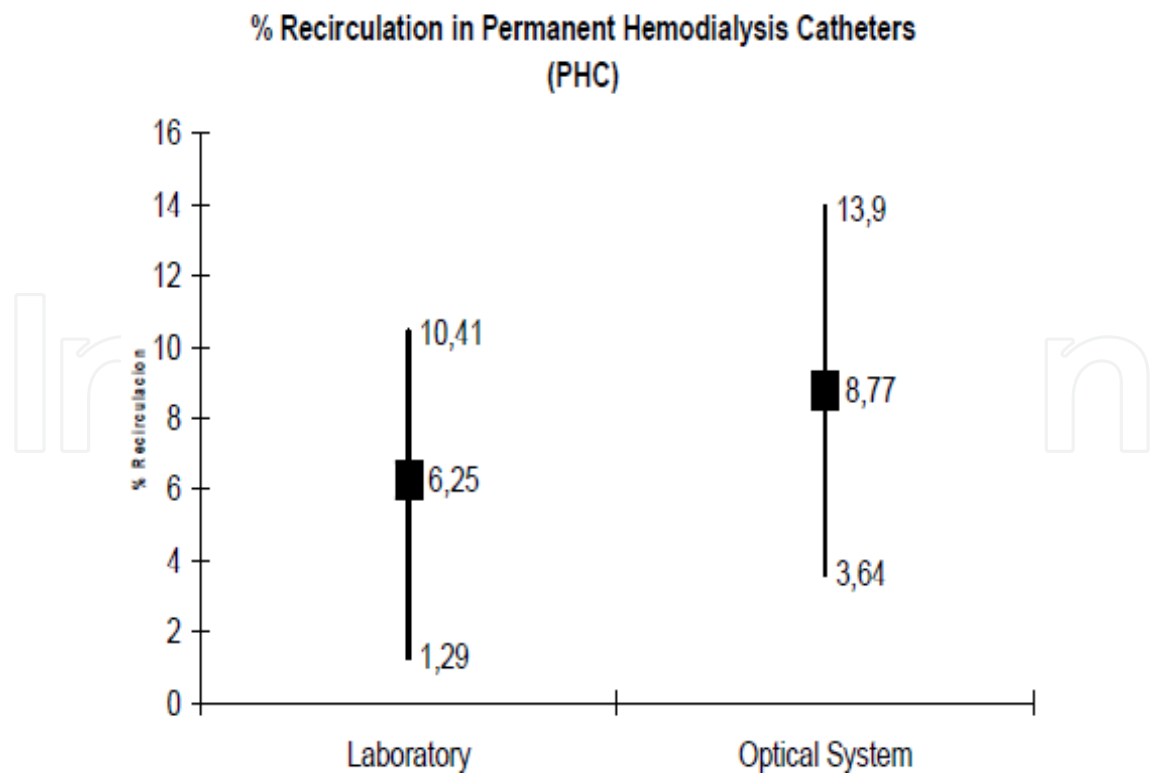

Fig. 6. Results obtained by Laboratory vs. Optical system for recirculation percentage Permanent Hemodialysis Catheter (PHC).

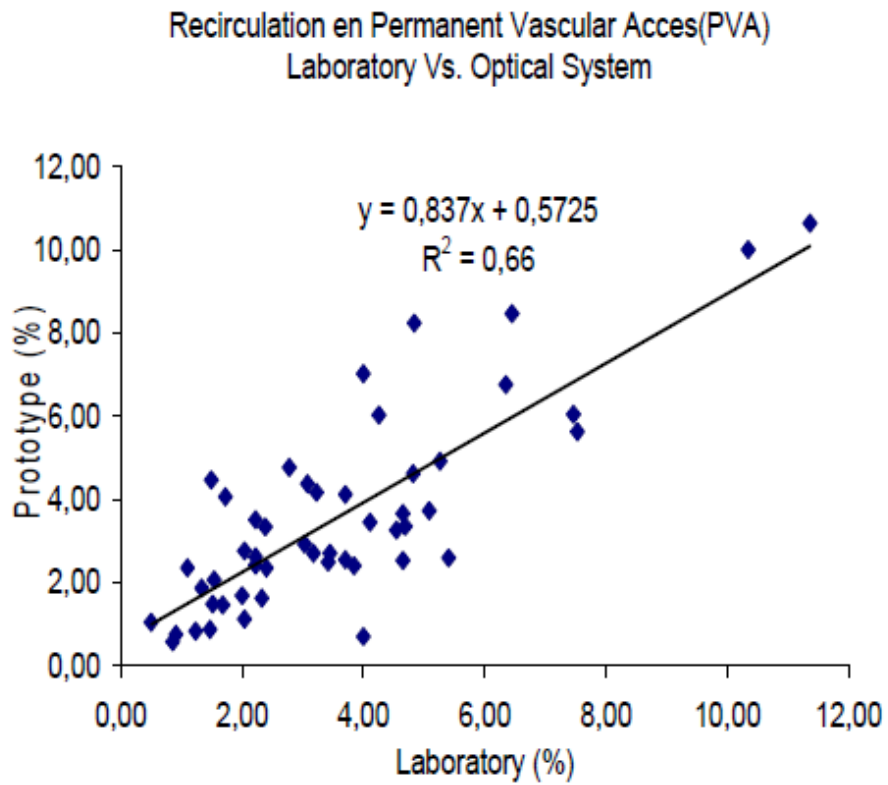

Fig. 7. Correlation between the laboratory analysis and optical system results for recirculation measurement in Permanent Vascular Access (PVA) is $R^2 = 0.66$.

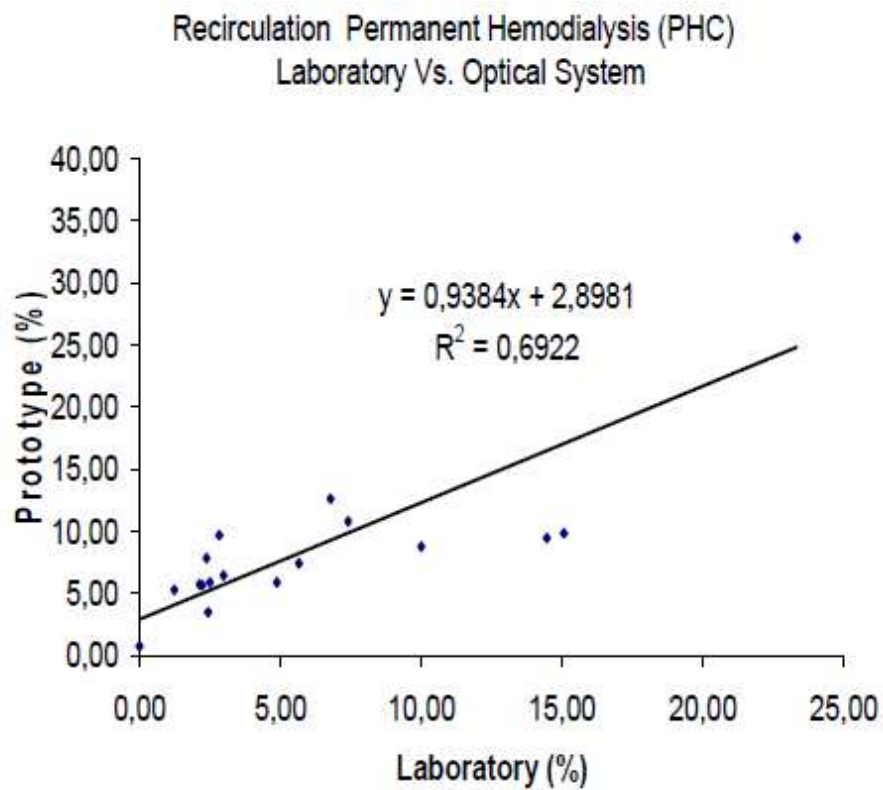

Fig. 8. Correlation between the laboratory analysis and optical system results for recirculation measurement in Permanent Hemodialysis Catheter (PHC) is $R^2 = 0.69$

There was no statistically difference in the recirculation between diabetic versus non diabetic ($P=0.28$) and hypertensive versus normotensive ($P=0.21\%$) hemodialysis patients.

The distances between arterial and venous needles were 5.53 ± 2.69 cm and 13.17 ± 3.38 cm respectively. It represents that there is a significant association between distances of needles ($P=0.002$) and improper needle placement ($P=0.000$) with degree of recirculation.

The average time between creation and use of A-V fistula were 71 ± 31 days and 46 ± 13 days. There were also a significant difference between them ($P=0.043$).

The length of time of A-V fistula use was 26.59 ± 9.37 months and 33.20 ± 7.35 months.

The mean A-V fistula flow rate in both groups was more than 400 ml/min. The mean A-V fistula flow rate was significantly ($p = 0.001$).

4. Discussions

The measurement of A-V Fistula Recirculation in HD patients is an important issue, since it appears to be an important cause of inadequate HD. In addition, some clinical guidelines are suggested regular monitoring of HD vascular access by methods such as vascular access recirculation for early detection and correction of access dysfunction.⁽¹⁰⁾

An accurate assessment of access fistula recirculation can be made by urea-based method as the same as the present study and nonurea-based techniques by ultrasound dilution technique, conductivity, or potassium-based dilutional method.^(11, 12, 13)

In urea-based method, it's usually measured by comparing the systemic and dialyzer inlet blood urea concentration. Urea concentration in blood entering the dialyzer (A in the above formula) is assumed to be equal to the systemic urea concentration (P in the above formula) if there is no recirculation.

There are different protocols for systemic blood urea sampling in the urea-based method measurement of access recirculation. In the three-needle or traditional method, the systemic urea concentration has been obtained from a peripheral vein in the contralateral arm. However, it is now recognized that this approach is inaccurate and tends to overestimate access recirculation because the BUN obtained from a peripheral vein is often higher than the BUN in the blood entering the dialyzer inlet, even in the absence of recirculation.⁽¹⁴⁾

Two factors contribute to this problem: Cardiopulmonary recirculation and veno/venous disequilibrium.^(15, 16, 17) Thus three-needle method dose not routinely use due to its requirement for additional venipuncture, unpredictable manner, and overestimation of access recirculation.

Sampling peripheral arterial blood eliminates the effects of both cardiopulmonary recirculation and venovenous disequilibrium. However arterial puncture during HD is not also practical and does not recommended.

Preferred alternatives to the peripheral vein or three-needle method and arterial puncture is two needle technique as same as use in the present study. In the study, systemic urea concentration is obtained from the dialyzer blood inlet line after slowing the blood pump to 50mL/min for about 30 seconds (P in the above formula).⁽¹⁸⁾ This "two-needle" technique as opposed to the use of three needles are presumably more accurate for the determination of access recirculation.⁽¹⁹⁾

In our study, the average degree of A-V fistula recirculation was 9.56 ± 2.32 percent and it was almost similar to findings of salimi et al in 2008, Bay et al in 1998, Besarab et al in 1997. These groups used two needle technique urea-based method as same as present study for measurement of recirculation. The average degree of recirculation in these groups were 8.7%, $11.8 \pm 9.9\%$ and $5.5 \pm 0.8\%$ respectively.^(20, 21, 22)

Depner et al have measured recirculation by ultrasound dilution technique and they reported recirculation rate of 8.82% during 34 HD session in 28 patients.⁽²³⁾

The most common causes of A-V fistula recirculation in HD` patients are the presence of high-grade venous stenoses, improper needle placement, inadequate arterial inflow and congestive heart failure.^(24, 25)

Moderate to sever venous stenoses can obstruct or restrict venous outflow from A-V fistula and as a result some dialyzed blood reenters to the dialytic circuit through the arterial needle for some times, thereby blood entering the dia-lyzer can become diluted with blood that has just left the dialyzer. Thus it can re-duce the effective clearance obtained in the course of a dialysis session.

Backflow or recirculation may increase with improper needle placement.⁽²⁵⁾ Close proximity and or misdirection of needles will increase the reentry of dia-lyzed blood into the arterial needle. Unfortunately, the role of misplacement of needles in recirculation, usually ignore but according to the present study it was the most common source of recirculation.

Some other centers have also reported that improper needle placement is a common source. Schneditz, for example, reported that improper needle place-ment is a common cause of A-V fistula recirculation, even after such placement had been previously recognized.⁽²⁵⁾

Therefore we should have more emphasis on specific training and education of HD nursing staffs. HD staffs should also know anatomy and physiology of A-V fistula and A-V fistula recirculation.

On the other hand, access recirculation can also be facilitated by inadequate arterial inflow.⁽²⁴⁾ In this setting, backflow from the venous side of the access is necessary to support the dialytic blood flow rate set by the blood pump. It appears that inadequate arterial inflow was not a cause in our study because although A-V fistula flow rate was between 400- 500ml/min in four patients, dialytic blood flow rate was lower and it was maintained at 300 mill/min.

5. Conclusions

The measurement of A-V Fistula Recirculation has important diagnostic implications in Hemodialysis patients because it is an important cause of inadequate dialysis. According to the study it was a common occurrence. Although, the role of improper arterial and venous needles placement in recirculation usually ignore, it was the most common cause in our HD patients. Therefore we should have more emphasis on education and training of Hemodialysis staffs.

6. References

- [1] USRDS: The United States Renal Data System: Overall hospitalization and mortality. *Am J Kidney Dis* 2003; 42 (6 suppl 5): S136-40.
- [2] Beladi Musavi, SS, Hayati, F, Alemzadeh Ansari, MJ, et al. Survival at 1, 3, and 5 Years in Diabetic and Nondiabetic Hemodialysis Patients. *IJKD* 2010; 4; 74-7.
- [3] USRDS: The United States Renal Data System. Excerpts from the USRDS 2008 annual data report: Atlas of end-stage renal disease in the United States. *Am J Kidney Dis* 2009; 1 (Suppl 1): S1.
- [4] Mailloux, LU, Bellucci, AG, Napolitano, B. Survival estimates for 683 patients starting dialysis from 1970 through 1989: Identification of risk factors for survival. *Clin Nephrol* 1994; 42: 127.

- [5] Murphy, SW, Foley, RN, Barrett, BJ. Comparative mortality of hemodialysis and peritoneal dialysis in Canada. *Kidney Int* 2000; 57: 1720-6.
- [6] Goodkin, DA, Bragg-Gresham, JL, Koenig, KG, Wolfe, RA. Association of comorbid conditions and mortality in hemodialysis patients in Europe, Japan, and the United States: the Dialysis Outcomes and Practice Patterns Study (DOPPS). *J Am Soc Nephrol* 2003; 14: 3270.
- [7] Miskulin, DC, Meyer, KB, Martin, AA. Comorbidity and its change predict survival in incident dialysis patients. *Am J Kidney Dis* 2003; 41: 149.
- [8] Sherman, RA. The measurement of dialysis access recirculation. *Am J Kidney Dis* 1993; 22: 616.
- [9] Michael, B, Thomas, AG, Theodore, WP, Peter, JB. Arterovenous fistula recirculation in hemodialysis, UP to date ver 17.2
- [10] K/DOQI Clinical Practice Guidelines and Clinical Practice Recommendations 2006 Updates Hemodialysis adequacy Peritoneal Dialysis Adequacy Vascular Access. *Am J Kidney Dis* 2006; 48 (Suppl 1): S1.
- [11] Brancaccio, D, Tessitore, N, Carpani, P. Potassium-based dilutional method to measure hemodialysis access recirculation. *Int J Artif Organs* 2001; 24: 606.
- [12] Bosc, JY, LeBlanc, M, Garred, LJ. Direct determination of blood recirculation rate in hemodialysis by a conductivity method. *ASAIO J* 1998; 44: 68.
- [13] Alloatti, S, Molino, A, Bonfant, G. Measurement of vascular access recirculation unaffected by cardiopulmonary recirculation: evaluation of an ultrasound method. *Nephron* 1999; 81: 25.
- [14] Sharman RA: Recirculation revisited. *Semin Dial* 4: 221-223, 1991.
- [15] Schenditz D, Polaschegg HD, Levin NW. Cardiopulmonary recirculation in dialysis- An underrecognized phenomenon. *ASAIO J* 38: M 196. 1992.
- [16] Schenditz D, Kaufman AM, Polaschegg HD. Cardiopulmonary recirculation during hemodialysis. *Kidney Int* 42: 1450- 456,1992.
- [17] Depner TA, Rizwan S, Sheer A, Wagner J: Peripheral urea disequilibrium during hemodialysis is temperature - dependent *ASAIO Trans* 37: 141-143, 1991.
- [18] Sherman, RA. The measurement of dialysis access recirculation. *Am J Kidney Dis* 1993; 22: 616.
- [19] Sherman, RA, Matera, JJ, Novik, L, Cody RP. Recirculation reassessed: The impact of blood flow rate and the low-flow method reevaluated. *Am J Kidney Dis* 1994; 23: 846.
- [20] Salimi J, Razeghi E, Karjalian H, et al Predicting Hemodialysis Access Failure with the Measurement of Dialysis Access Recirculation. *Saudi J Kidney Dis Transpl* 2008; 19:781-4.
- [21] Bay WH, Henry ML, Lazarus JM, et al. Predicting hemodialysis access failure with color flow Doppler ultra-sound. *Am J Nephrol* 1998; 18 (4): 296-304.
- [22] Besarab A, Sherman R. The relationship of recirculation to access blood flow. *Am J Kidney Dis* 1997; 29 (): 223-9.
- [23] Depner, Thomas A.; Krivitski, Nikolai M.; MacGibbon, David. Hemodialysis Access Recirculation Measured by Ultrasound Dilution. *ASAIO Journal* 1995; 41 (suppl 3).
- [24] Sherman R, Levy SS: Rate- related recirculation: the effect of altering blood flow on dialysis- an underrecognized phenomenon. *ASAIO J* 38: M194- M196; 1992.
- [25] Schneditz, D. Recirculation, a seemingly simple concept. *Nephrol Dial Transplant* 1998; 13: 2191.
- [26] NKF-DOQI clinical practice guidelines for vascular access XII Recirculation methodology, limit, evaluation and follow up. *Am J Kidney Dis* 2001; 37 (supply 1): s155.

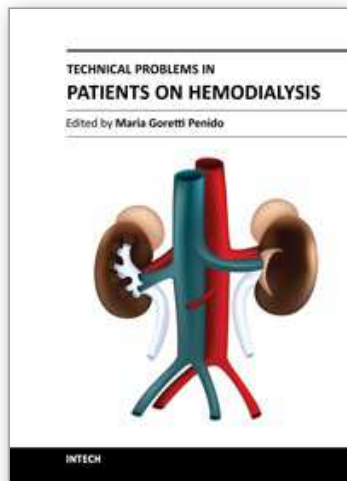

Technical Problems in Patients on Hemodialysis

Edited by Prof. Maria Goretti Penido

ISBN 978-953-307-403-0

Hard cover, 312 pages

Publisher InTech

Published online 07, December, 2011

Published in print edition December, 2011

This book provides an overview of technical aspects in treatment of hemodialysis patients. Authors have contributed their most interesting findings in dealing with hemodialysis from the aspect of the tools and techniques used. Each chapter has been thoroughly revised and updated so the readers are acquainted with the latest data and observations in the area, where several aspects are to be considered. The book is comprehensive and not limited to a partial discussion of hemodialysis. To accomplish this we are pleased to have been able to summarize state of the art knowledge in each chapter of the book.

How to reference

In order to correctly reference this scholarly work, feel free to copy and paste the following:

G.A. Martinez (2011). Measuring System of Urea in Blood by Application in Recirculation for Hemodialysis Treatment, Technical Problems in Patients on Hemodialysis, Prof. Maria Goretti Penido (Ed.), ISBN: 978-953-307-403-0, InTech, Available from: <http://www.intechopen.com/books/technical-problems-in-patients-on-hemodialysis/measuring-system-of-urea-in-blood-by-application-in-recirculation-for-hemodialysis-treatment>

INTECH
open science | open minds

InTech Europe

University Campus STeP Ri
Slavka Krautzeka 83/A
51000 Rijeka, Croatia
Phone: +385 (51) 770 447
Fax: +385 (51) 686 166
www.intechopen.com

InTech China

Unit 405, Office Block, Hotel Equatorial Shanghai
No.65, Yan An Road (West), Shanghai, 200040, China
中国上海市延安西路65号上海国际贵都大饭店办公楼405单元
Phone: +86-21-62489820
Fax: +86-21-62489821

© 2011 The Author(s). Licensee IntechOpen. This is an open access article distributed under the terms of the [Creative Commons Attribution 3.0 License](#), which permits unrestricted use, distribution, and reproduction in any medium, provided the original work is properly cited.

IntechOpen

IntechOpen