

# We are IntechOpen, the world's leading publisher of Open Access books Built by scientists, for scientists

4,800

Open access books available

122,000

International authors and editors

135M

Downloads

Our authors are among the

154

Countries delivered to

TOP 1%

most cited scientists

12.2%

Contributors from top 500 universities



WEB OF SCIENCE™

Selection of our books indexed in the Book Citation Index  
in Web of Science™ Core Collection (BKCI)

Interested in publishing with us?  
Contact [book.department@intechopen.com](mailto:book.department@intechopen.com)

Numbers displayed above are based on latest data collected.  
For more information visit [www.intechopen.com](http://www.intechopen.com)



# Applications of Interval-Based Simulations to the Analysis and Design of Digital LTI Systems

Juan A. López<sup>1</sup>, Enrique Sedano<sup>1</sup>, Luis Esteban<sup>2</sup>, Gabriel Caffarena<sup>3</sup>,  
Angel Fernández-Herrero<sup>1</sup> and Carlos Carreras<sup>1</sup>

<sup>1</sup>*Departamento de Ingeniería Electrónica, Universidad Politécnica de Madrid,*

<sup>2</sup>*Laboratorio Nacional de Fusión, Centro de Investigaciones Energéticas  
Medioambientales y Tecnológicas (CIEMAT),*

<sup>3</sup>*Departamento de Ingeniería de Sistemas de Información y de Telecomunicación,  
Universidad CEU-San Pablo,  
Spain*

## 1. Introduction

As the complexity of digital systems increases, the existing simulation-based quantization approaches soon become unaffordable due to the exceedingly long simulation times. Thus, it is necessary to develop optimized strategies aimed at significantly reducing the computation times required by the algorithms to find a valid solution (Clark et al., 2005; Hill, 2006). In this sense, interval-based computations are particularly well-suited to reduce the number of simulations required to quantize a digital system, since they are capable of evaluating a large number of numerical samples in a single interval-based simulation (Caffarena et al., 2009, 2010; López, 2004; López et al., 2007, 2008).

This chapter presents a review of the most common interval-based computation techniques, as well as some experiments that show their application to the analysis and design of digital Linear Time Invariant (LTI) systems. One of the main features of these computations is that they are capable of significantly reducing the number of simulations needed to characterize a digital system, at the expense of some additional complexity in the processing of each operation. On the other hand, one of the most important problems associated to these computations is interval oversizing (i.e., the computed bounds of the intervals are wider than required), so new descriptions and methods are continuously being proposed. In this sense, each description has its own features and drawbacks, making it suitable for a different type of processing.

The structure is as follows: Section 2 presents a general review of the main interval-based computation methods that have been proposed in the literature to perform fast evaluation of system descriptions. For each technique, the representation of the different types of computing elements is given, as well as the main advantages and disadvantages of each approach. Section 3 presents three groups of interval-based experiments: (i) a comparison of the results provided by two different interval-based approaches to show the main problem

of interval-based computations; (ii) an analysis of the application of interval-based computations to measure and compare the sensitivity of the signals in the frequency domain; and (iii) an analysis of the application of interval-based techniques to the Monte-Carlo method. Finally, Section 4 concludes this work.

## 2. General overview of interval-based computations

### 2.1 Interval arithmetic

Since its formalization in 1962 by R. Moore (Moore, 1962), Interval Arithmetic (IA) has been widely used to bound uncertainties in complex systems (Moore, 1966). The main advantage of traditional IA is that it is able to obtain the range of all the possible results of a given function. On the other hand, it suffers from three different types of problems (Neumaier, 2002): the dependency problem, the cancellation problem, and the wrapping effect.

The dependency problem expresses that IA computations overestimate the output range of a given function whenever it depends on one or more of its variables through two or more different paths. The cancellation problem occurs when the width of the intervals is not canceled in the inverse functions. In particular, this situation occurs in the subtraction operations (i.e., given the non-empty interval  $I_1 - I_1 \neq 0$ ), what can be seen as a particular case of the dependency problem, but its effect is clearly identified. The wrapping effect occurs because the intervals are not able to accurately represent regions of space whose boundaries are not parallel to the coordinate axes.

These overestimations are propagated in the computations and make the results inaccurate, and even useless in some cases. For this reason, the Overestimation Factor (OF) (Makino & Berz, 2003; Neumaier, 2002) has been defined as

$$OF = (\text{Estimated Range} - \text{Exact Range}) / (\text{Exact Range}), \quad (1)$$

to quantify the accuracy of the results. Another interesting definition used to evaluate the performance of these methods is the Approximation Order (Makino & Berz, 2003; Neumaier, 2002), defined as the minimum order of the monomial  $C\varepsilon^s$  (where  $C$  is constant, and  $\varepsilon \in [0,1]$ ) that contains the difference between the bounds of the interval function and the target function in the range of interest.

### 2.2 Extensions of interval arithmetic

The different extensions of IA try to improve the accuracy of the computed results at the expense of more complex representations. A classification of the main variants of IA is given in Figure 1.

According to the representation of the uncertainties, the extensions of IA can be classified in three different types: Extended IA (EIA), Parameterized IA and Centered Forms (CFs). In a further division, these methods are further classified as follows. In the first group, Directed Intervals (DIs) and Modal Intervals (MIs); in the second group, Generalized IA (GIA); and in the third group, Mean Value Forms (MVF), slopes, Taylor Models (TMs) and Affine Arithmetic (AA). A brief description of each formulation is given below.

DIs (Kreinovich, 2004) include the direction or sign of each interval to avoid the cancellation problem in the subtraction operations ( $I_1^+ - I_1^+ = 0$ ), which is the most important source of overestimation (Kaucher, 1980; Ortoolf, Bonn, 1969).

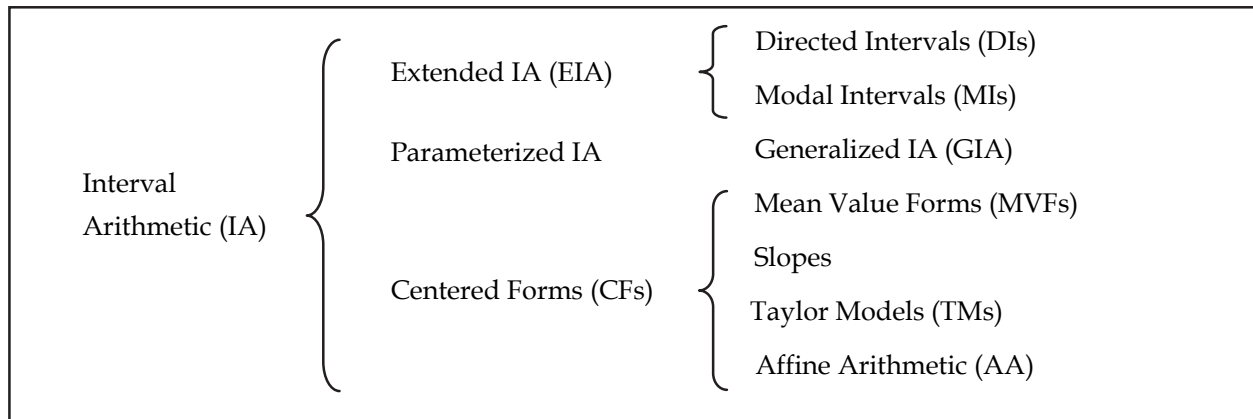

Fig. 1. Classification of interval-based computations methods.

In MIs (Gardenes, 1985; Gardenes & Trepate, 1980; SIGLA/X, 1999a, 1999b), each element is composed of one interval and a parameter called "modality" that indicates if the equation of the MIs holds for a single value of the interval or for all its values. These two descriptions are used to generate equations that bound the target function. If both descriptions exist and are equal, the result is exact. Among the publications on MIs, the underlying theoretical formulation and the justifications are given in (SIGLA/X, 1999a) and the applications, particularly for control systems, are given in (Armengol, et al., DX-2001; SIGLA/X, 1999b; Vehí, 1998)

GIA (Hansen, 1975; Tupper, 1996) is based on limiting the regions of the represented domain using intervals with parameterizable endpoints, such as  $[1 - 2x, 3 + 4x]$  with  $x \in [0,1]$ . The authors define different types of parameterized intervals (constant, linear, quadratic, linear, multi-dimensional, functional and symbolic), but their analysis has focused on evaluating whether the target function is increasing or decreasing, concave or convex, in the region of interest using constant, linear and polynomial parameters. In the experiments, they have obtained the areas where the existence of the function is impossible, but they conclude that this type of analysis is too complex for parameterizations greater than the linear case.

In the different representations, CFs are based on representing a function as a Taylor Series expansion with one or more intervals that incorporate the uncertainties. Therefore, all these techniques are composed of one independent value (the central point of the function) and a set of summands that incorporate the intervals in the representation.

MVs (Alefeld, 1984; Coconut\_Group, 2002; Moore, 1966; Neumaier, 1990; Schichl & Neumaier, 2002) are based on developing an expression of a first-order Taylor Series that bounds the region of interest. The general expression is as follows:

$$f(x) = f(x_0) + f'(x)(x - x_0) \in f_{MV}(I_x) = f(x_0) + f'(I_x)(I_x - x_0) \quad (2)$$

where  $x$  is the point or region where  $f(x)$  must be evaluated,  $x_0$  is the central point of the Taylor Series, and  $I_x$  is the interval that bounds the uncertainty range. The computation of the derivative is not complex when the function is polynomial, as it is usually the case in function approximation methods. Since the approximation error is quadratic, this method does not provide good results when the input intervals are large. However, if the input intervals are small, it provides better results than traditional IA.

The slopes (Moore, 1966; Neumaier, 1990; Schichl & Neumaier, 2002) also use a first-order Taylor Series expansion, but they apply the Newton's method to recursively compute the values of the derivatives. Its general expression is as follows:

$$f(x) = f(x_0) + f'(x)(x - x_0) \quad \in \quad f_S(I_S, I_x) = f(x_0) + I_S(I_x - x_0) \quad (3)$$

where  $I_S$  is determined according to the expression (Garloff, 1999):

$$I_S = \begin{cases} \frac{f(x) - f(x_0)}{x - x_0} & \text{if } x \neq x_0 \\ x_0 & \text{if } x = x_0 \end{cases} \quad (4)$$

It is worth mentioning that slopes typically provide better estimates than MVFs by a factor of 2, and that the results can be further improved by combining their computation with IA (Schichl & Neumaier, 2002)

TMs (Berz, 1997, 1999; Makino & Berz, 1999) combine a  $N$ -order Taylor Series expansion with an interval that incorporates the uncertainty in the function under analysis. Its mathematical expression is as follows:

$$f_{TM}(x, I_n) = a_n x^n + a_{n-1} x^{n-1} + \dots + a_1 x + a_0 + I_n \quad (5)$$

where  $a_i$  is the  $i$ -th coefficient of the interpolation polynomial of order  $n$ , and  $I_n$  is the uncertainty interval for this polynomial. The approximation error has now order  $N+1$ , rather than quadratic as in previous cases. In addition, TMs improve the representation of the domain regions, which reduces the wrapping effect. The applications of TMs have been largely studied thanks to the development of the tool COSY INFINITY (Berz, 1991, 1999; Berz, et al., 1996; Berz & Makino, 1998, 2004; Hoefkens, 2001; Hoefkens, et al., 2001, 2003; Makino, 1998, 1999). The main features of this tool include the resolution of Ordinary Differential Equations (ODEs), higher order ODEs and systems, multivariable integration, and techniques for relieving the wrapping effect, the dimensionality course, and the cluster effect (Hoefkens, 2001; Makino & Berz, 2003; Neumaier, 2002). Another relevant contributor in the development of the TMs is the GlobSol project (Corliss, 2004; GlobSol\_Group, 2004; Kearfott, 2004; Schulte, 2004; Walster, 2004), focused on the application of interval computations to different applications, including systems modeling, computer graphics, gene prediction, missile design tips, portfolio management, foreign exchange market, parameter optimization in medical measures, software development of Taylor operators, interval support for the GNU Fortran compiler, improved methods of automatic differentiation, resolution of chemical models, etc. (GlobSol\_Group, 2004).

There are discussions about the capabilities of TMs to solve the different theoretical and applied problems. In this sense, it is worth mentioning that "the TMs only reduce the problem of bounding a factorable function to bounding the range of a polynomial in a small box centered at 0. However, they are good or bad depending on how they are applied to solve each problem." (Neumaier, 2002). This statement is also applicable to the other uncertainty computation methods.

In AA (Comba & Stolfi, 1993; Figuereido & Stolfi, 2002; Stolfi & Figuereido, 1997), each element or affine form consists of a central value plus a set of noise terms (NTs). Each NT is composed of one uncertainty source identifier, called Noise Symbol (NS), and a constant coefficient associated to it. The mathematical expression is:

$$f_{AA}(\varepsilon_i) = x' = x_c + x_0 \varepsilon_0 + x_1 \varepsilon_1 + \varepsilon_2 x_2 + \dots + \varepsilon_n x_n \quad (6)$$

where  $x'$  represents the affine form,  $x_c$  is the central point, and each  $\varepsilon_i$  and  $x_i$  are the NS and its associated coefficient. In AA the operations are classified in two types: affine and non-affine operations. Affine operations (addition and constant multiplication) are computed without error, but non-affine operations need to include additional NTs to provide the bounds of the results. The main advantage of AA is that it keeps track of the different noise symbols and cancels all the first-order uncertainties, so it is capable of providing accurate results in linear sequences of operations. In nonlinear systems, AA obtains quadratic convergence, but the increment of the number of NTs in the nonlinear operations makes the computations less accurate and more time-consuming. A detailed analysis of the implementation of AA and a description of the most relevant computation algorithms is given in (Stolfi & Figueredo, 1997).

Among other applications, AA has been successfully used to evaluate the tolerance of circuit components (Femia & Spagnuolo, 2000), the sizing of analog circuits (Lemke, et al., Nov. 2002), the evolution of deformable models (Goldenstein, et al., 2001), the evaluation of polynomials (Shou, et al., 2002), and the analysis of the Round-Off Noise (RON) in Digital Signal Processing (DSP) systems (Fang, 2003; López, 2004; López et al., 2007, 2008), etc. Modified AA (MAA) (Shou, et al., 2003) has been proposed to accurately compute the evolution of the uncertainties in nonlinear descriptions. Its mathematical expression is as follows:

$$f_{MAA}(e_i^k) = x' = x_c + x_0 e_0 + x_1 e_1 + x_2 e_0^2 + x_3 e_0 e_1 + x_4 e_1^2 + \dots + x_n \prod_{i,k} e_i^k \quad (7)$$

It is easy to see that MAA is an extension of AA that includes the polynomial NTs in the description. Thus, it is capable of computing the evolution of higher-order uncertainties that appear in polynomial descriptions (of a given smooth system), but the number of terms of the representation grows exponentially with the number of uncertainties and the order of the polynomial description. Thus, in this case it is particularly important to keep the number of NTs of the representation under a reasonable limit.

Obviously, the higher order NTs are not required when computing the evolution of the uncertainties in LTI systems, so MAA is less convenient than AA in this case.

### 3. Interval-based analysis of DSP systems

This Section examines the variations of the properties of the signals that occur in the evaluation of the DSP systems when Monte-Carlo Simulations (MCS) are performed using Extensions of IA (EIA) instead of the traditional numerical simulations. The simulations based on IA and EIA can handle the uncertainties and nonlinearities associated, for example, to the quantization operations of fixed-point digital filters, and other types of systems in the general case.

The most relevant advantages of using EIA to evaluate DSP systems can be summarized in the following points:

1. It is capable of managing the uncertainties associated with the quantization of coefficients, signals, complex computations and nonlinearities.
2. It avoids the cancellation problem of IA.
3. It provides faster results than the traditional numerical simulations.

The intuitive reason that determines the benefits of EIA is simple. Since EIA is capable of processing large sets of data in a single interval-based simulation, the results are obtained faster than in the separate computation of the numerical samples. Although the use of intervals imposes a limitation of connectivity on the computation of the results, both the speed and the accuracy are improved with respect to the numerical processing of the same number of samples.

Section 3.1 discusses the cancellation problem in the analysis of digital filter structures using IA, and justifies the selection of AA for such analysis, indicating the cases in which it can be used, and under what types of restrictions. Section 3.2 examines how the Fourier Transform is affected when uncertainties are included in one or all of the samples. Section 3.3 evaluates the changes that occur in the parameters of the random signals (mean, variance and Probability Density Function (PDF)) when a specific width is introduced in the samples, and how these changes affect the computed estimates using the Monte-Carlo method. Finally, Section 3.4 provides a brief discussion to highlight the capabilities of interval-based simulations.

### 3.1 Analysis of digital filter structures using IA and AA

The main problem that arises when performing interval-based analyses of DSP systems using IA is that the addition and subtraction operations always increase the interval widths. If there are variables that depend on other variables through two or more different paths, such as in  $z(k) = x(k) - x(k)$ , the ranges provided by IA are oversized. This problem, called the cancellation problem, is particularly severe when there are feedback loops in the realizations, a characteristic which is common in most DSP systems.

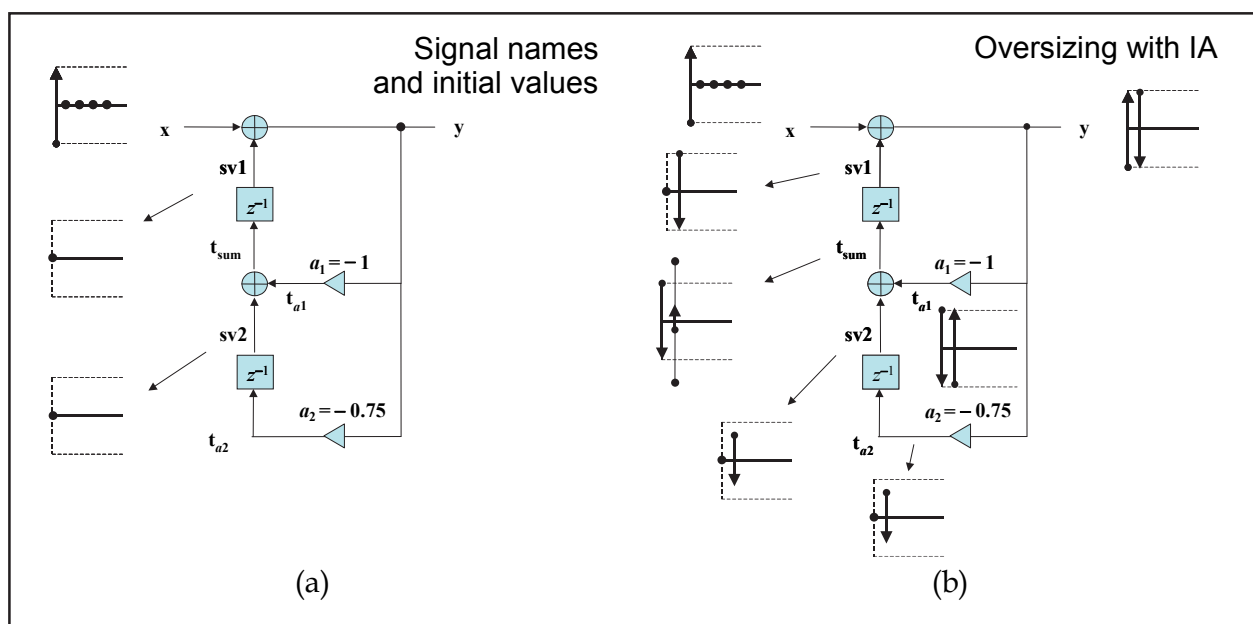

Fig. 2. Interval oversizing due to the cancellation effect of IA: (a) Signal names and initial (interval) values. (b) Computed intervals until the oversizing in the variable  $t_{sum}$  is detected. In each small figure, the abscissa axis represents the sampled time, and the ordinate axis represents the interval values. A dot in a given position represents the interval  $[0,0]$ .

Figure 2.a shows a second-order Infinite Impulse Response (IIR) filter realized in direct form, whose transfer function is

$$H(z) = \frac{1}{1 + a_1z^{-1} + a_2z^{-2}} = \frac{1}{1 + z^{-1} + 0.75z^{-2}}. \tag{8}$$

It is initially assumed that the filter is implemented using infinite precision, which implies that the quantization effects are negligible and that all signals are generated as linear combinations of the input and the state variables. This assumption allows: (i) to perform a separate analysis of the mean and the width of the intervals; and (ii) to generalize the results obtained in the simulation of a normalized interval to larger or smaller ones.

Figure 2.b shows the oversizing that occurs in the IA simulation. The input is set to the normalized interval  $[-1, 1]$ , and the state variables are initially set to zero. Here, the representations are based on oriented intervals to keep track of the position of the samples in each interval, and to detect the overestimations. The initial values and the evolution of the intervals are:

$$x = [-1, 1] \Rightarrow y = [-1, 1] \Rightarrow \left\{ \begin{array}{l} t_{a1} = [1, -1] \Rightarrow t_{sum} = [1, -1] \Rightarrow sv_1 = [1, -1] \\ sv_2 = [0.75, -0.75] \end{array} \right. \tag{9}$$

and in the next sampled time the values are:

$$\left. \begin{array}{l} sv_1 = [1, -1] \Rightarrow y = [1, -1] \Rightarrow t_{a1} = [-1, 1] \\ sv_2 = [0.75, -0.75] \end{array} \right\} \Rightarrow t_{sum} = [-1.75, 1.75] \tag{10}$$

instead of  $t_{sum} = [-0.25, 0.25]$ , which is the correct value. Figure 2.b also shows that this oversizing occurs because signal  $t_{sum}$  depends on the input signal through two different paths.

Since AA includes a separate signed identifier per uncertainty source, it avoids such overestimations and provides the smallest intervals. In this case, the initial values and the evolution of the affine forms are:

$$x = 2\varepsilon \Rightarrow y = 2\varepsilon \Rightarrow \left\{ \begin{array}{l} t_{a1} = 2\varepsilon \Rightarrow t_{sum} = 2\varepsilon \Rightarrow sv_1 = 2\varepsilon \\ sv_2 = -1.5\varepsilon \end{array} \right. \tag{11}$$

and in the next sampled time

$$\left. \begin{array}{l} sv_1 = 2\varepsilon \Rightarrow y = 2\varepsilon \Rightarrow t_{a1} = 2\varepsilon \\ sv_2 = -1.5\varepsilon \end{array} \right\} \Rightarrow t_{sum} = 0.5\varepsilon \tag{12}$$

which corresponds to the most accurate interval  $[-0.25, 0.25]$ .

This simple example confirms the selection of AA instead of IA, particularly in structures with feedback loops. Although the cancellation effect is not necessarily present in all the structures, it commonly appears in most DSP realizations. For this reason, it is highly recommended to use this arithmetic when performing interval-based analysis of DSP systems.

When there are multiple simultaneous uncertainty sources, it is necessary to use an oriented identifier for each source, in addition to the average value of the signals, which are the elements offered by AA to perform the computations. Moreover, the objective of AA is to



accurately determine the results of the linear operations (additions, subtractions, constant multiplications and delays), and the purpose of the filters is to perform a given linear transformation of the input signal. Consequently, the features offered by AA match perfectly with the requirements of the interval-based simulations of the unquantised digital filter structures.

When the quantization operations are included in this type of analysis, the affine forms must be adjusted to include all the possible values of the results. Since AA keeps track of the effects of the uncertainty sources (the noise terms can be seen as the first-order relationship between each uncertainty source and the signals), the affine forms are easily modified to simulate the effects of the quantization operations in the structures containing feedback loops.

In summary, one of the most important problems of IA to perform accurate interval-based simulations of the DSP realizations is the cancellation problem. The use of AA, in combination with the modification of the affine forms in the quantization operations, solves this problem and allows performing accurate analysis of the linear structures, even when they contain feedback loops.

### 3.2 Computation of the fourier transform of deterministic interval-based signals

The analysis of deterministic signals in DSP systems is of great importance, since most systems use or modify their properties in the frequency domain to send the information. In this sense, the decomposition of the signals using the Fourier transform as finite or infinite sums of sinusoids allows to evaluate these properties. Conversely, it is also widely known that a sufficient condition to characterize the linear systems is to determine the variations of the properties of the sinusoids of the different frequencies.

The following experiment shows the variations of the properties of deterministic signals when intervals of a given width are included in one or all of their samples. These widths represent the possible uncertainties in these signals and their effect on their associated signals in the transformed domain.

First, we evaluate the effects of including uncertainties of the same width in all the samples of the sequence. The steps required to perform this example are as follows:

1. Generate the Fast Fourier Transform (FFT) program file, specifying the number of stages.
2. Generate the sampled sinusoidal signals to be used as inputs.
3. Include the uncertainty specifications in the input signals.
4. Compute the Fourier Transform (run the interval-based simulation).
5. Repeat the steps 1-4 modifying the widths of the intervals of step 3.
6. Repeat the previous steps modifying the periods of the sinusoids of step 2.

Steps 1 to 4 generate the FFT of the interval-based sinusoidal signals. Step 5 has been included to investigate the effects of incorporating uncertainties of a given width to all input samples of the FFT. By superposition, this should be equal to the numerical FFT of the mean values of the original signal, plus another FFT in which all the input intervals are centered in zero and they all have the same width. Finally, step 6 allows us to investigate the variations of the computed results according to the periods of the sinusoids.

Figure 3 shows two examples of cosine signals with equal-width intervals in all the samples and their respective computed FFTs. Figure 3.a corresponds to a cosine signal of amplitude 1, length 1024, period 32, and width 1/8 in all the samples, and Figure 3.c

shows another cosine signal of the same amplitude and width, length 256 and period 8. Figures 3.b and 3.d show the computed FFTs for each case, where each black line represents a data interval.

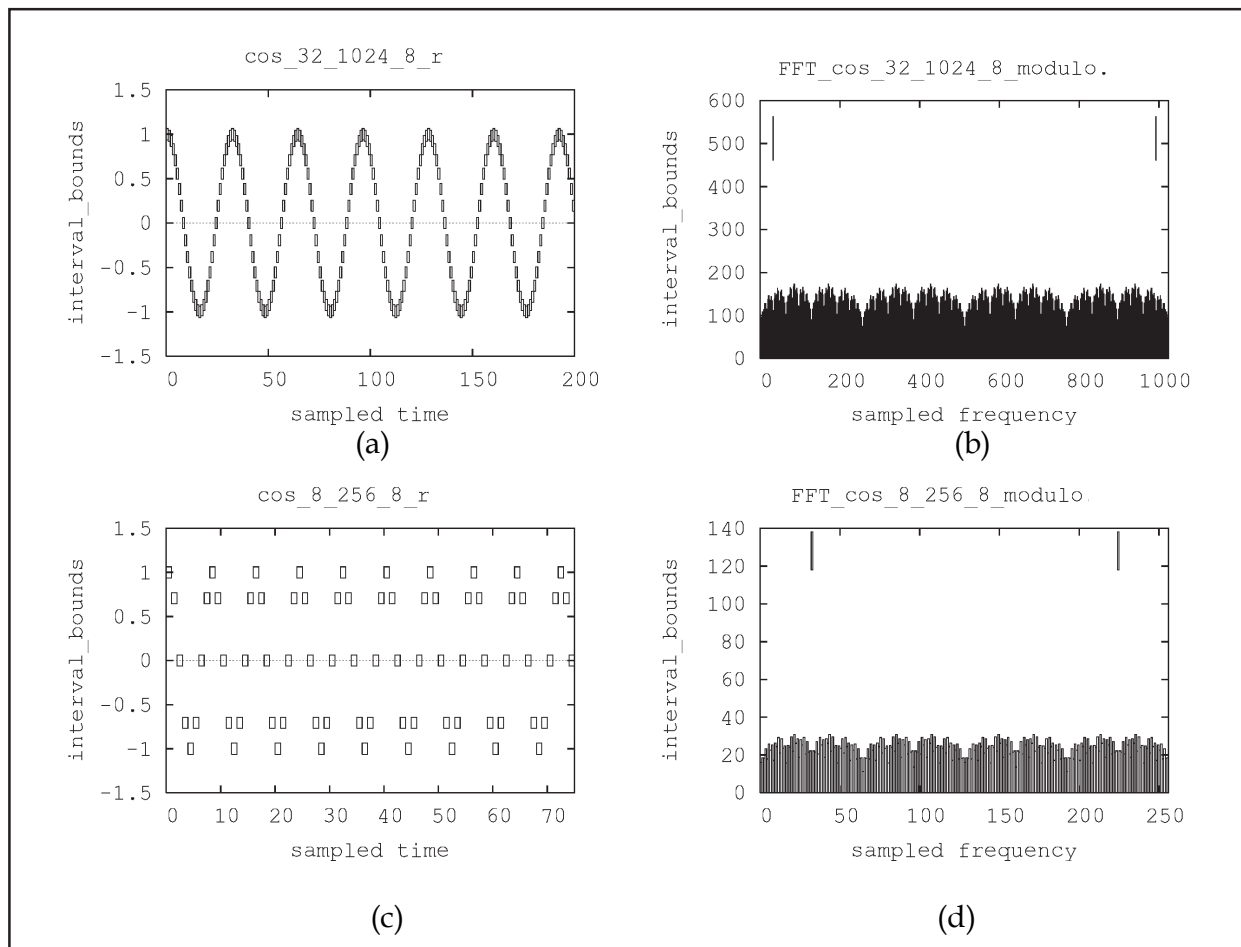

Fig. 3. Examples of FFTs of deterministic interval signals: (a) First 200 samples of a cosine signal of length 1024, period 32, and interval widths  $1/8$  in all the samples. (b) FFT of the previous signal. (c) First 75 samples of a cosine signal of length 256, period 8, and interval widths  $1/8$  in all the samples. (d) FFT of the previous signal.

As expected, these figures clearly show that the output intervals in the transformed domain have the form of the numerical transform, plus a given level of uncertainty in all the samples. In addition, Figures 3.b and 3.d also provide: (i) the values of the deviations in the transformed domain in each sample with respect to the numerical case, and (ii) the maximum levels of uncertainty associated with the uncertainties of the inputs.

The second part of this experiment evaluates how each uncertainty separately affects to the FFT samples. As mentioned above, by performing a separate analysis of how each uncertainty affects to the input samples, we are characterizing the quantization effects of the FFT. In this case, step 3 is replaced by the following statement:

3. Include one uncertainty in the specified sample of the input signals.

which is performed by generating a delta interval in the specified position, and adding it to the input signal.

Figure 4.a shows a cosine signal of length 1024 and period 32, in which only an interval of width 1/5 in the sample 27 has been included, and Figure 4.b shows the computed FFT of the previous interval trace. In this case, two small intervals appear in the sampled frequencies 32 and 968, as well as in the values near 0 in the other frequencies. Unlike the results shown in Figure 3, the uncertainties associated with the input interval are very small in this case.

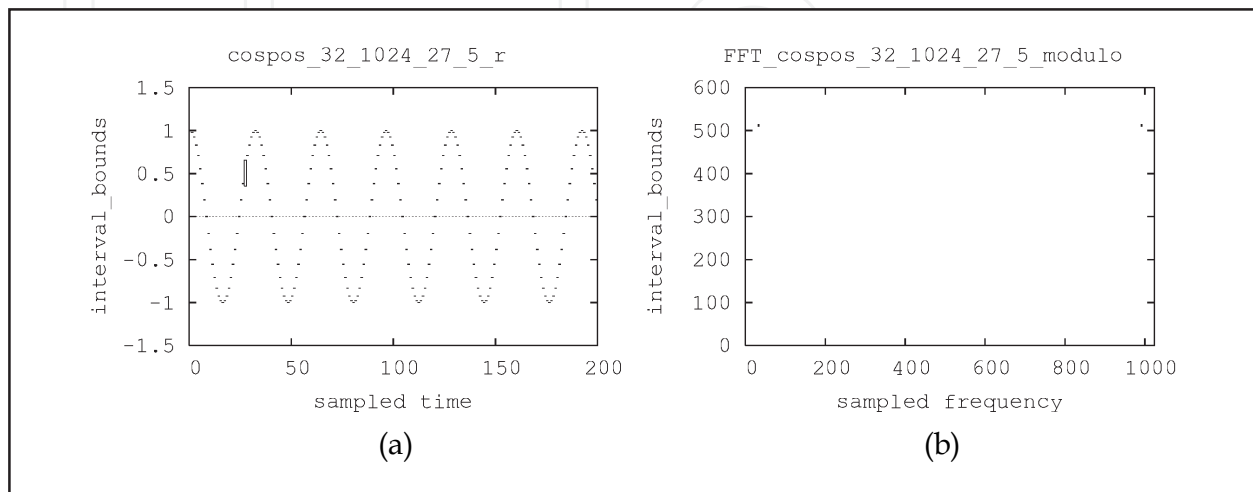

Fig. 4. Example of an FFT of a deterministic signal with a single interval: (a) First 200 samples of a cosine signal of length 1024, period 32 and interval width 1/5 in the sample 27. (b) FFT of the previous signal, with two small uncertainties in the sampled frequencies 32 and 968.

Figure 5 shows the details of the ripples generated by the uncertainties according to their positions in each trace. In the first case (Figure 5.a), the interval has been included in sample 16, which is a factor of the number of FFT points. In this case, there is no ripple. In the other three cases (Figures 5.b-d), the interval has been included in three different positions (17, 20 and 27, respectively), and there is a small ripple in the transformed domain, different in each case. Since the FFTs are linear systems, the large ripples that appear in the Figures 3.b and 3.d are the sum of all the possible equal-width ripples in the frequency domain.

In summary, the inclusion of intervals in sinusoidal signals and the computation of the FFTs show the maximum and minimum deviations in the frequency domain due to the different uncertainties. It has been found that the uncertainties do not affect to all the frequencies of the FFT in the same way, and that their effects depend on their positions in the trace. Although the intervals represent the maximum values of the uncertainties and the noise is commonly associated to the second-order statistics, the variations in the computed interval widths implies that the noise generated by the FFT is not white, but follows a deterministic pattern.

### 3.3 Analysis of the statistical parameters of random signals using interval-based simulations

The following experiments show the variations of the statistical parameters of random signals (mean, variance and PDF) when random sequences are generated using the Monte-Carlo method, using intervals of a specified width instead of the traditional numerical simulations.

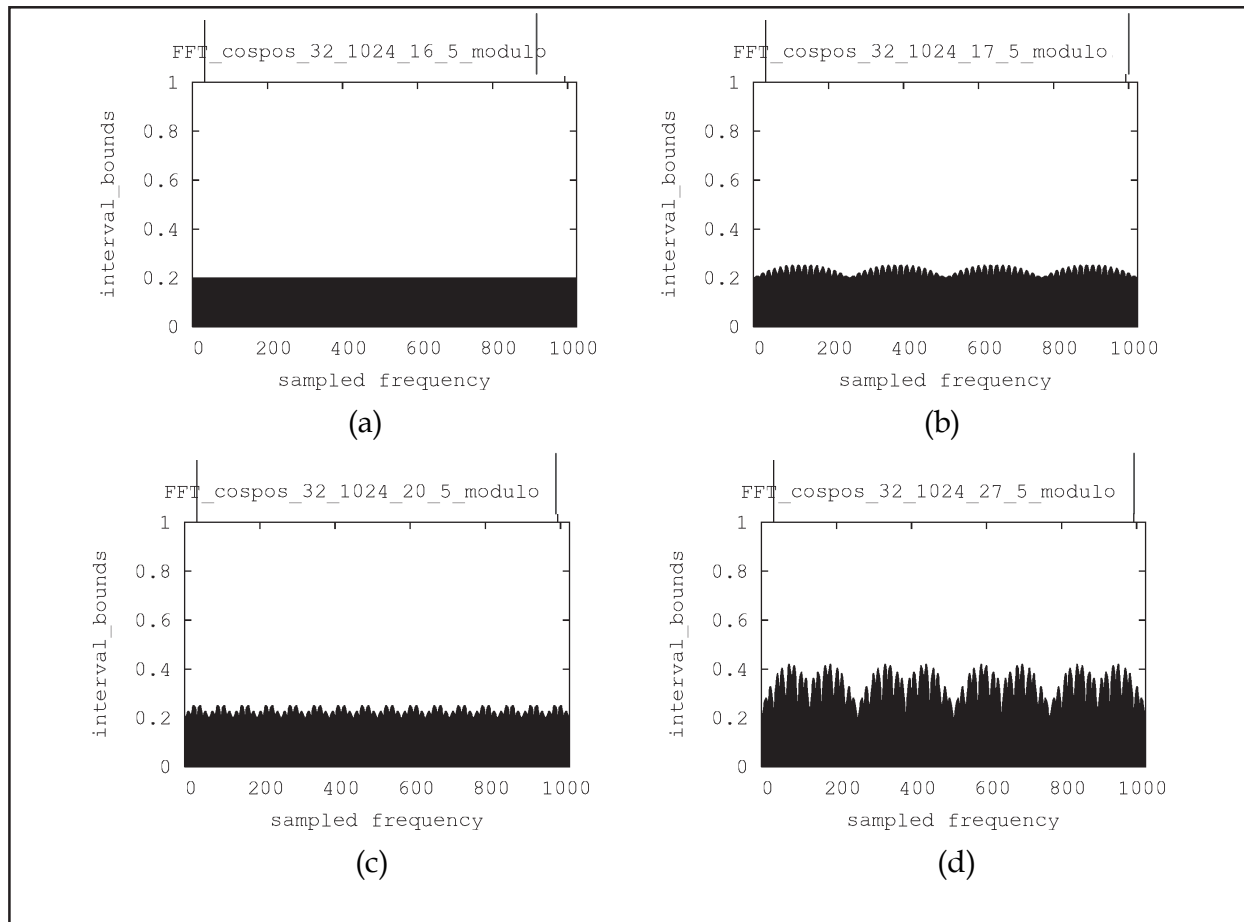

Fig. 5. Details of the ripples that occur in the transformed domain due to the presence of uncertainty intervals in the deterministic signals: (a) in a position which is a factor of the number of FFT points (16). (b) - (d) in other non-factor positions (17, 20 and 27, respectively). The vertical lines above the figures indicate the positions of the deltas, whose heights exceed the representable values in the graph.

The first part of this section analyzes the changes in the PDFs. To do this, data sequences following a particular PDF are generated, and they are later reconstructed and compared with the original results. The steps used to perform the experiments are as follows:

1. Generate the traces of the random samples following the specified PDF, and assign the width of the intervals.
2. Obtain the histogram of the trace, group the samples and plot the computed PDF.
3. Repeat steps 1 and 2 to reduce the variance of the parameters ( $M$  times).
4. Average the histograms obtained in step 3.
5. Repeat the previous steps assigning other interval widths.

Step 1 generates the sequences of samples that follow the specified PDF, and in step 2 the PDFs are recomputed from these samples. In this experiment, three types of PDFs have been used: (i) a uniform PDF in  $[-1, 1]$ , a normalized normal PDF (mean 0 and variance 1), and a bimodal PDF composed of two normal PDFs, with means -3 and 3 and variance 1. Steps 3 and 4 have been included to reduce the variance of the results. Finally, step 5 allows selecting other interval widths.

Figure 6 presents the results of the three histograms using the Monte-Carlo method with: (i) numerical samples, (ii) intervals whose width is set to  $1/8$  of the variance, and (iii) intervals

whose width is set to the variance of the distribution. All the histograms have been computed using 20 averages of 5000 data items each. It can be seen that the areas near the edges on the uniform distribution are modified, but the remaining parts of the distribution are also computed taking into account a larger number of points. It is also noticeable that the new PDFs are smoother than the ones computed using the numerical traces, which can be explained from the Central Limit Theorem.

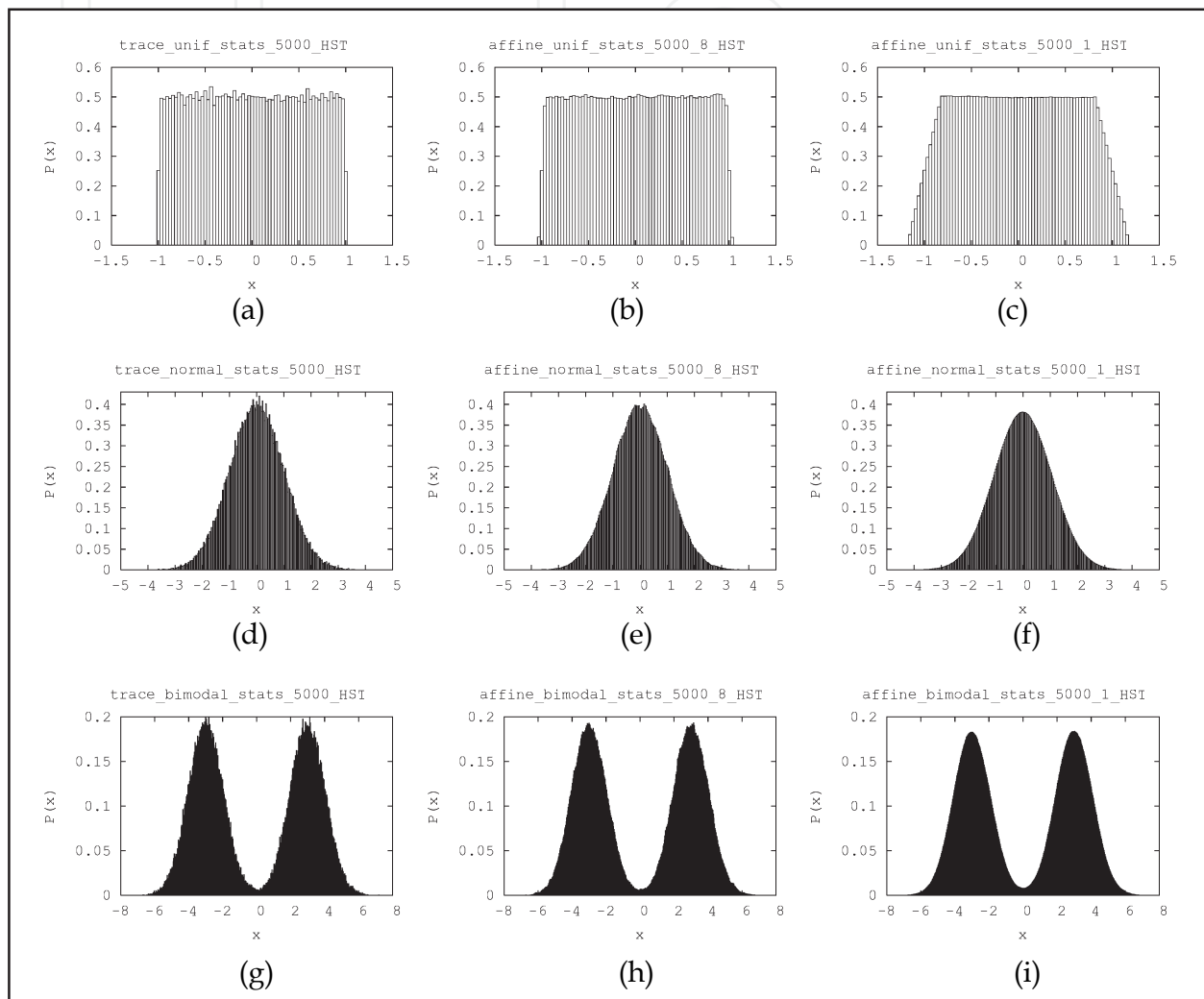

Fig. 6. Distributions generated using traces of numbers, traces of intervals whose widths are set to  $1/8$  of the variance, and traces of intervals whose widths are set to the variance of the distribution. These traces are applied using the Monte Carlo Method to: (a) - (c) a uniform distribution in  $[-1, 1]$ ; (d) - (f) a normal distribution with mean 0 and variance 1; (g) - (i) a bimodal distribution with modes 3 and -3 and variance 1.

Figure 7 details the central part and the tails of a normal distribution generated using traces of 100000 numbers and 5000 intervals. It can be observed that the transitions of the histograms are much smoother in the distribution generated using intervals. Although there are slight deviations from the theoretical values, these deviations (approximately 5% in the central part and 15% in the tails) are comparable to the deviations obtained by the numerical trace using 100000 numbers.

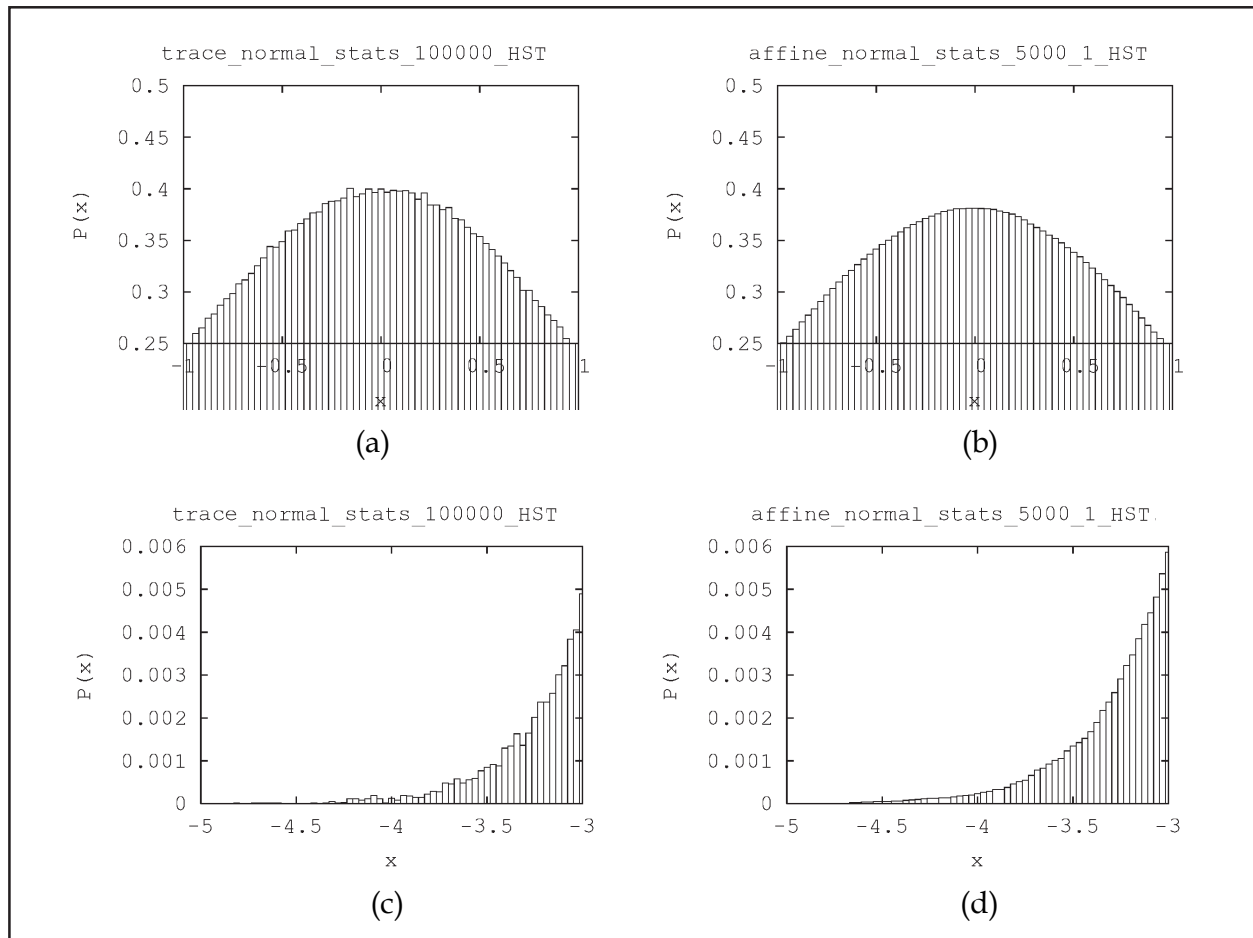

Fig. 7. Details of the normal distribution generated with numerical and interval traces: (a) and (b) Central part of the distribution; (c) and (d) Tail of the distribution.

Therefore, this experiment has shown that signals with normal distributions maintain their shape and statistical parameters in the interval-based simulations, but they require fewer computations to obtain similar degrees of accuracy.

The second part of this section evaluates the variations of the statistical estimators when interval samples of a specific width are used to compute the mean and variance of the random signals in the simulations. Now, the sequence of steps is as follows:

1. Generate the traces of the random samples following the specified PDF, and assign the width of the intervals.
2. Compute the mean and the variance of the trace.
3. Repeat steps 1 and 2 to reduce the variance of the parameters ( $M$  times).
4. Group the means and variances of the computed traces, and obtain the estimation and the variations of the statistical parameters.
5. Repeat the previous steps assigning other interval widths.

These steps allow the computation of the means and variances of the estimators, instead of averaging the computed histograms. Step 2 computes the mean and variance of the signals specified in step 1, and step 4 averages the results of the mean and variance of the estimators (in this experiment  $M$  is high, to ensure the reliability of estimator statistics).

Figure 8 shows the evolution of the estimators of the mean and the variance as a function of the lengths of the traces (500, 1000 and 5000 samples) and the widths of the intervals

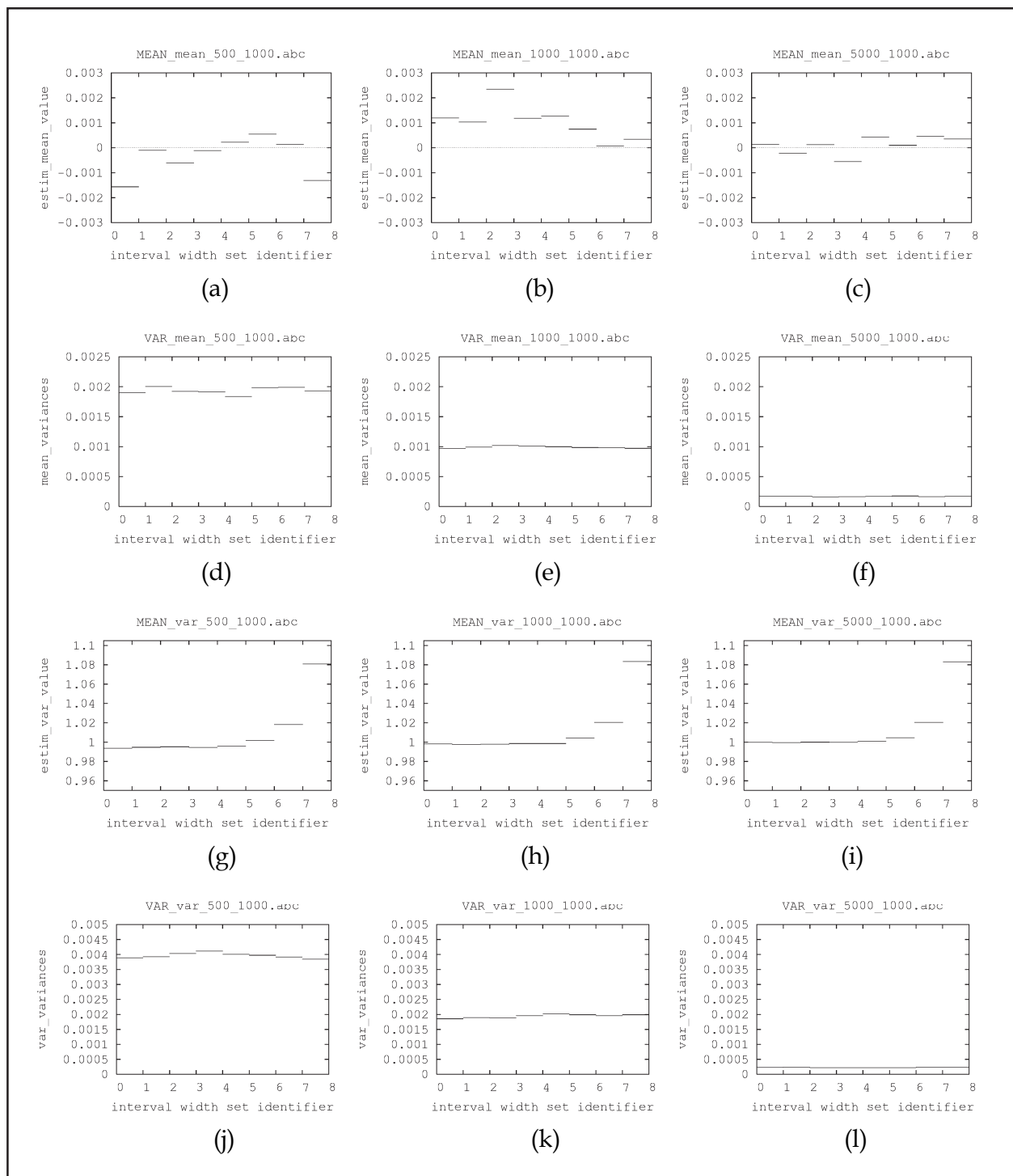

Fig. 8. Analysis of the values provided by the mean and variance interval-based estimators depending on the lengths of the traces: (a) - (c) average of the mean estimator, (d) - (f) variance of the mean, (g) - (i) mean of the variance of the estimator, (j) - (l) variance of the variance. In the four cases, the first column represents the average of 1000 simulations using traces of 500 samples; the second column, of 1000 samples; and the third column, of 5000 samples. The values of the abscissa (1 to 8) respectively represent the interval widths: 0, 1/64, 1/32, 1/16, 1/8, 1/4, 1/2 and 1.

(between 0 and 1). Figures 8.a-c show the averaged mean values computed by the estimator for the previous three lengths. It can be observed that the interval-based estimators tend to obtain slightly better results than the ones of the numerical simulation, although they are roughly of the same order of magnitude. Figures 8.d-f show the variances of these computations. In this case, all the results are approximately equal, and the values decrease (i.e. they become more precise) with longer simulations. Figures 8.g-i show the mean of the variance of the interval-based simulations estimator. It can be observed that when the intervals have small widths, the ideal values are obtained, but when the interval widths are comparable to the variance of the distribution (approximately from 1/4 of its value) the computed values increase significantly the variance of the estimator. Figures 8.j-l show the evolution of the variance estimator. The results are approximately equal in all cases, and decrease with the longer simulations.

Therefore, interval-based simulations tend to reduce the edges of the PDFs and to equalize the other parts of the distribution according to the interval widths. If no additional operation is performed, the edges of the PDFs may change significantly, particularly in uniform distributions. However, since these effects are known, they can possibly be compensated. When using normal signals, the mean and variance of the MC method are similar to the ones obtained in numerical simulations, but the mean of the variance tends to grow for widths above 1/8 of the variance. However, since the improvement in the computed accuracy is small, it does not seem to compensate the increased complexity of the process.

### 3.4 Discussion on interval-based simulations

Section 3.1 has revealed the importance of using EIA in the interval-based simulation of DSP systems, particularly when they contain feedback loops. It has also shown that traditional IA provides overestimated results due to the cancellation problem. Although the analysis has been performed through a simple example, it can be shown that this problem occurs in most IIR realizations of order equal or greater than two. If there are no dependencies, IA provides the same results than AA, but AA is recommended to be used in the general case. In interval-based simulations of quantized systems, the affine forms must be modified to include all the possible values of the quantization operations without increasing the number of noise terms. The proposed approach solves the overestimation problem, and allows performing accurate analysis of linear systems with feedback loops.

Another important conclusion is that, since the propagation of uncertainties in AA is accurate for linear computations, the features of AA perfectly match with the requirements of the interval-based simulations of digital filters and transforms.

Section 3.2 has evaluated the effects of including one or more uncertainties in a deterministic signal. In addition to determining the maximum and minimum bounds of the variations of the signals in the frequency domain, the analyses have shown the position of the largest uncertainties. Since these amplitudes are not equal, the noise at the output of the FFT does not seem to be white. Moreover, its effect seems to be dependent on the position of the uncertainties in the time domain. The analyses based on interval computations have detected this effect, but they must be combined with statistical techniques to verify the results. A more precise understanding of these effects would help to recover weak signals in environments with low signal-to-noise ratios.

In Section 3.3 the effects of using intervals or extended intervals of a given width in the Monte-Carlo method instead of the traditional numerical simulations has been analyzed. In the first part, the results show that this type of processing softens the edges and the peaks of



the PDFs, although these effects can be reduced by selecting smaller intervals or by preprocessing the probability function. In particular, normal distributions are better defined (due to the Central Limit Theorem) and, if the widths of the intervals are significantly smaller than the variance of the distribution, the differences with respect to the theoretical PDFs are smaller than with numerical simulations using the same number of samples. In the second part, the evolution of the mean and the variance of the mean and variance estimators has been studied for a normal PDF using the Monte-Carlo method for different interval widths. These estimators behave similarly than their numerical counterparts (slightly better in most cases), but the mean of the variance increases when the interval widths are greater than  $1/8$  of the variance of the distribution. Moreover, the increased complexity associated to the interval-based computations does not seem to compensate the small improvement of the accuracy of the statistical estimators in the general case.

In summary, interval-based simulations are preferred when the PDFs are being evaluated, but these improvements are not significant when only the statistical parameters are computed. If the distributions contain edges (for example in the uniform or histogram-based distributions), a pre-processing or post-processing stage can be included to cancel the smoothing performed by the interval sets. Otherwise (such in normally distributed signals), this step can be avoided.

#### 4. Conclusions and future work

This chapter has presented a detailed review of the interval-based simulation techniques and their application to the analysis and design of DSP systems. First, the main extensions of the traditional IA have been explained, and AA has been selected as the most suitable arithmetic for the simulation of linear systems. MAA has also been introduced for the analysis of nonlinear systems, but in this case it is particularly important to keep the number of noise terms of the affine forms under a reasonable limit.

Second, three groups of experiments have been performed. In the first group, a simple IIR filter has been simulated using IA and AA to detail the causes of the oversizing of the IA-based simulations, and to determine why AA is particularly well suited to solve this problem. In the second group, different deterministic traces have been simulated using intervals of different widths in some or all the samples. This experiment has revealed the most sensitive frequencies to the small variations of the signals. In the third group, the effect of including intervals in the computation of the statistical parameters using the Monte-Carlo method has been studied. Thanks to these experiments, it has been shown that interval-based simulations can reduce the number of samples of the simulations, but the edges of the distributions are softened by this type of processing.

Finally, it is important to remark that interval-based simulations can significantly reduce the computation times in the analysis of DSP systems. Due to their features, they are particularly well suited to perform rapid system modeling, verification of the system stability, and fast and accurate determination of finite wordlength effects.

#### 5. Acknowledgment

This work has been partially supported by the Ministerio de Ciencia e Innovación of Spain under project TEC2009-14219-C03-02, and the E.T.S.I. Telecomunicación of the Universidad Politécnica de Madrid under the FastCFD project.

## 6. References

- Alefeld, G. (1984), The Centered Form and the Mean Value Form - A Necessary Condition that They Yield the Range, *Computing*, 33, 165-169.
- Armengol, J.; Vehí, J.; Travé-Massuyès, L. & Sainz, M. A. (DX-2001), Application of Multiple Sliding Time Windows to Fault Detection Based on Interval Models, *12th International Workshop on Principles of Diagnosis*.
- Berz, M. (1991), *Forward Algorithms for High Orders and Many Variables*.
- Berz, M. (1997), *COSY INFINITY Version 8 Reference Manual*.
- Berz, M. (1999), *Modern Map Methods in Particle Beam Physics*, Academic Press, San Diego.
- Berz, M.; Bischof, C.; Griewank, A. & Corliss, G. (1996), *Computational Differentiation: Techniques, Applications and Tools*.
- Berz, M. & Makino, K. (1998), "Verified Integration of ODEs and Flows Using Differential Algebraic Methods on High-Order Taylor Models", *Reliable Computing*, 4, 4, 361-369.
- Berz, M. & Makino, K. (2004), *Taylor Model Research: Results and Reprints*.
- Caffarena, G.; López, J.A.; Leyva, G.; Carreras C.; Nieto-Taladriz, O., (2009), Architectural Synthesis of Fixed-Point DSP Datapaths using FPGAs, *International Journal of Reconfigurable Computing*, vol. 2009, 14 pages.
- Caffarena, G.; López, J.A.; Leyva, G.; Carreras C.; Nieto-Taladriz, O., (2010), SQNR Estimation of Fixed-Point DSP Algorithms, *EURASIP Journal on Advances in Signal Processing*, vol. 2010, article 21, 12 pages.
- Clark, M.; Mulligan, M.; Jackson, D.; & Linebarger, D. (2005), Accelerating Fixed-Point Design for MB-OFDM UWB Systems. *CommsDesign*. Online available at: <http://www.commsdesign.com/showArticle.jhtml?articleID=57703818>.
- Coconut\_Group (2002), *COCONUT, CONTinuous CONstraints - UpdatiNg the Technology - IST Project funded by the European Union*.
- Comba, J. L. D. & Stolfi, J. (1993), *Affine Arithmetic and Its Applications to Computer Graphics*, 9-18.
- Corliss, G. F. (2004), *G.F. Corliss Homepage*, <http://www.eng.mu.edu/corlissg/>
- Fang, C. F.; Chen, T. & Rutenbar, R. A. (2003), "Floating-point error analysis based on affine arithmetic", *Proc. IEEE Int. Conf. on Acoustics, Speech, and Signal Processing (ICASSP '03)*, 2, 561-564.
- Femia, N. & Spagnuolo, G. (2000), "True Worst-Case Circuit Tolerance Analysis Using Genetic Algorithms and Affine Arithmetic", *IEEE Trans. Circuits and Systems I: Fundamental Theory and Applications*, 47, 9, 1285-1296.
- Figueredo, L. H. d. & Stolfi, J. (2002), "Affine Arithmetic: Concepts and Applications", *10th GAMM - IMACS International Symposium on Scientific Computing, Computer Arithmetic, and Validated Numerics, SCAN 2002*.
- Gardenes, E. (1985), "Modal Intervals: Reasons and Ground Semantics", *Lecture Notes in Computer Science*, 212, 27-35.
- Gardenes, E. & Trepát, A. (1980), "Fundamentals of SIGLA, an Interval Computing System over the Completed Set of Intervals", *Computing*, 24, 161-179.
- Garloff (1999), *Introduction to Interval Computations*.
- GlobSol\_Group (2004), *GlobSol Homepage*, <http://caneos.mcmaster.ca/solvers/GLOB:GLOBSOL/>
- Goldenstein, S.; Vogler, C. & Metaxas, D. (2001), *Affine Arithmetic Based Estimation of Cue Distributions in Deformable Model Tracking*.
- Hansen, E. R. (1975), *A Generalized Interval Arithmetic*, 7-18.
- Hill, T. (2006), *Acceldsp synthesis tool floating-point to fixed-point conversion of matlab algorithms targeting fpgas*. White paper, Xilinx.

- Hoefkens, J. (2001), *Verified Methods for Differential Algebraic Equations*.
- Hoefkens, J.; Berz, M. & Makino, K. (2001), *Verified High-Order Integration of DAEs and Higher-Order ODEs*, 281-292.
- Hoefkens, J.; Berz, M. & Makino, K. (2003), "Controlling the Wrapping Effect in the Solution of ODEs of Asteriods", *Reliable Computing*, 9, 1, 21-41.
- Kaucher, E. (1980), "Interval Analysis in the Extended Interval Space IR", *Computing Suppl.*, 2, 33-49.
- Kearfott, R. B. (2004), *R.B. Kearfott Homepage*. <http://interval.louisiana.edu/kearfott.html>
- Kreinovich, V. (2004), *The Interval Computations Homepage*. <http://www.cs.utep.edu/interval-comp/>
- Lemke, A.; Hedrich, L. & Barke, E. (Nov. 2002), *Analog Circuit Sizing Based on Formal Methods Using Affine Arithmetic*.
- López, J.A. (2004), *Evaluación de los Efectos de Cuantificación en las Estructuras de Filtros Digitales Utilizando Técnicas de Cuantificación Basadas en Extensiones de Intervalos*, Ph.D. Thesis, Univ. Politécnica de Madrid.
- López, J.A.; Carreras, C. & Nieto-Taladriz O. (2007), Improved Interval-Based Characterization of Fixed-Point LTI Systems With Feedback Loops, *IEEE Trans. Computer-Aided Design of Integrated Circuits and Systems*, vol. 26, pp. 1923-1933.
- López, J.A.; Caffarena, G.; Carreras, C. & Nieto-Taladriz O. (2008), Fast and accurate computation of the roundoff noise of linear time-invariant systems, *IET Circuits, Devices & Systems*, vol. 2, pp. 393-408.
- Makino, K. (1998), *Rigorous Analysis of Nonlinear Motion in Particle Accelerators*,
- Makino, K. (1999), "Efficient Control of the Dependency Problem Based on Taylor Model Methods", *Reliable Computing*, 5, 1, 3-12.
- Makino, K. & Berz, M. (1999), "COSY INFINITY Version 8", *Nuclear Instruments and Methods*, A427, 338-343.
- Makino, K. & Berz, M. (2003), "Taylor Models and Other Validated Functional Inclusion Methods", *Int. J. of Pure and Applied Mathematics*, 4, 4, 379-456.
- Moore, R. E. (1966), *Interval analysis*, Prentice-Hall.
- Moore, R. E. (1962), *Interval Arithmetic and Automatic Error Analysis in Digital Computing*,
- Neumaier, A. (1990), *Interval Methods for Systems of Equations*.
- Neumaier, A. (2002), "Taylor Forms, Use and Limits", *Reliable Computing*, 9, 43-79.
- Ortoff, J. H. (Bonn, 1969), "Eine Verallgemeinerung der Intervallarithmetic", *Gesellschaft fuer Mathematik und Datenverarbeitung*, 11, 1-71.
- Schichl, H. & Neumaier, A. (2002), *Interval Analysis – Basics*.
- Schulte, M. J. (2004), *M.J. Schulte Homepage*.  
[http://www.engr.wisc.edu/ece/faculty/schulte\\_michael.html](http://www.engr.wisc.edu/ece/faculty/schulte_michael.html)
- Shou, H.; Lin, H.; Martin, R. & Wang, G. (2003), "Modified Affine Arithmetic Is More Accurate than Centered Interval Arithmetic or Affine Arithmetic", *Mathematics of Surfaces, 10th IMA International Conference, Proceedings*, 2768 / 2003, 355 - 365.
- Shou, H.; Martin, R.; Voiculescu, I.; Bowyer, A. & Wang, G. (2002), "Affine Arithmetic in Matrix Form for Polynomial Evaluation and Algebraic Curve Drawing", *Progress in Natural Science*, 12, 1, 77-81.
- SIGLA/X (1999a), *Ground Construction of Modal Intervals*.
- SIGLA/X (1999b), *Applications of Interval Analysis to Systems and Control*, 127-227.
- Stolfi, J. & Figuereido, L. H. d. (1997), *Self-Validated Numerical Methods and Applications*.
- Tupper, J. A. (1996), *Graphing Equations with Generalized Interval Arithmetic*.
- Vehí, J. (1998), *Anàlisi i Disseny de Controladors Robustos Mitjançant Interval Modals*,
- Walster, G. W. (2004), *G.W. Walster Papers*, <http://www.mscs.mu.edu/globsol/walster-papers.html>.



## **Applications of Digital Signal Processing**

Edited by Dr. Christian Cuadrado-Laborde

ISBN 978-953-307-406-1

Hard cover, 400 pages

**Publisher** InTech

**Published online** 23, November, 2011

**Published in print edition** November, 2011

In this book the reader will find a collection of chapters authored/co-authored by a large number of experts around the world, covering the broad field of digital signal processing. This book intends to provide highlights of the current research in the digital signal processing area, showing the recent advances in this field. This work is mainly destined to researchers in the digital signal processing and related areas but it is also accessible to anyone with a scientific background desiring to have an up-to-date overview of this domain. Each chapter is self-contained and can be read independently of the others. These nineteenth chapters present methodological advances and recent applications of digital signal processing in various domains as communications, filtering, medicine, astronomy, and image processing.

### **How to reference**

In order to correctly reference this scholarly work, feel free to copy and paste the following:

Juan A. López, Enrique Sedano, Luis Esteban, Gabriel Caffarena, Angel Fernández-Herrero and Carlos Carreras (2011). Applications of Interval-Based Simulations to the Analysis and Design of Digital LTI Systems, Applications of Digital Signal Processing, Dr. Christian Cuadrado-Laborde (Ed.), ISBN: 978-953-307-406-1, InTech, Available from: <http://www.intechopen.com/books/applications-of-digital-signal-processing/applications-of-interval-based-simulations-to-the-analysis-and-design-of-digital-lti-systems>

**INTECH**  
open science | open minds

### **InTech Europe**

University Campus STeP Ri  
Slavka Krautzeka 83/A  
51000 Rijeka, Croatia  
Phone: +385 (51) 770 447  
Fax: +385 (51) 686 166  
[www.intechopen.com](http://www.intechopen.com)

### **InTech China**

Unit 405, Office Block, Hotel Equatorial Shanghai  
No.65, Yan An Road (West), Shanghai, 200040, China  
中国上海市延安西路65号上海国际贵都大饭店办公楼405单元  
Phone: +86-21-62489820  
Fax: +86-21-62489821

© 2011 The Author(s). Licensee IntechOpen. This is an open access article distributed under the terms of the [Creative Commons Attribution 3.0 License](#), which permits unrestricted use, distribution, and reproduction in any medium, provided the original work is properly cited.

IntechOpen

IntechOpen