

# We are IntechOpen, the world's leading publisher of Open Access books Built by scientists, for scientists

**4,800**

Open access books available

**122,000**

International authors and editors

**135M**

Downloads

Our authors are among the

**154**

Countries delivered to

**TOP 1%**

most cited scientists

**12.2%**

Contributors from top 500 universities



**WEB OF SCIENCE™**

Selection of our books indexed in the Book Citation Index  
in Web of Science™ Core Collection (BKCI)

Interested in publishing with us?  
Contact [book.department@intechopen.com](mailto:book.department@intechopen.com)

Numbers displayed above are based on latest data collected.

For more information visit [www.intechopen.com](http://www.intechopen.com)



# Removal of H<sub>2</sub>S and CO<sub>2</sub> from Biogas by Amine Absorption

J.I. Huertas, N. Giraldo and S. Izquierdo

*Automotive Engineering Research Center-CIMA of Tecnológico de Monterrey, Mexico*

## 1. Introduction

Due to strategic and environmental reasons, currently, there is an increasing interest in biofuels as alternative energy source. Bio-alcohols and biodiesel are the alternatives been considered for auto-motion while biomass and biogas are the alternatives been considered for electrical power generation.

Biogas is a medium-energy content fuel (~22 MJ/kg) derived from the organic material decomposition under anaerobic conditions (Horikawa et al, 2004). It can be obtained from landfills or from bio-digesters that transform manure and biomass into natural fertilizer in farms after 25-45 days of residence time. Due to its gaseous nature and the impossibility of producing it intensively, it is not attractive for large scale power generation.

However, recently, a new approach for electric power generation has been emerging. It consists of inter-connecting thousands of small and medium scale electrical plants powered by renewable energy sources to the national or regional electrical grids. It is considered to interconnect the hundreds of the existing small aero generators and solar panels (Pointon & Langan, 2002). Even though, there are still several technical issues to be resolved, this alternative of distributed electrical power generation is being considered as the best alternative to bring electricity to the rural communities located far away from the large urban centers.

In this case, the use of the biogas generated in the thousands of existing farms and landfills, as fuel for internal combustion engines connected to an electric generator becomes a very attractive alternative for electric power generation because of its very low cost, high benefit-cost ratio and very high positive impact on the environment.

Biogas is made up mainly of methane (CH<sub>4</sub>) and carbon dioxide (CO<sub>2</sub>). It also contains traces of hydrogen sulfide (H<sub>2</sub>S). Its composition varies depending on the type of biomass. Table 1 shows its typical composition.

The biogas calorific power is proportional to the CH<sub>4</sub> concentration. To be used as fuel for internal combustion engines, it has been recommended a CH<sub>4</sub> concentration greater than 90% (Harasimowicz et al, 2007). However CO<sub>2</sub> has a typical concentration of ~ 40%. This high CO<sub>2</sub> concentration reduces the engine power output proportionally to its concentration, limiting the use of biogas in electrical power plants driven by internal combustion engines (Marchaim, 1992).

The high content of H<sub>2</sub>S (~3500 ppm) causes corrosion in the metallic parts at the interior of the engine. The H<sub>2</sub>S is an inorganic acid that attacks the surface of metals when they are

placed in direct contact. Sulfur stress cracking (SSC) is the most common corrosive mechanism that appears when the metal makes contact with  $H_2S$ . Sulfides of iron and atomic hydrogen are formed in this process. This mechanism starts to take place when the  $H_2S$  concentration is higher than 50 ppm (Gosh, 2007). The admission valves, bronze gears and the exhaust system are also attacked by the presence of  $H_2S$ . The degree of deterioration of the engines varies considerably. Results obtained experimentally on this regard are contradictory (Gonzalez et al, 2006; Marchaim, 1992). It has been found that  $H_2S$  in biogas diminishes the life time of the engine by 10 to 15% (Horikawa & Rossi, 2004). Finally, time between oil changes is reduced since lubricant oils contain  $H_2S$  and corrosion inhibitors to protect the engine. It increases the maintenance cost of the engine. Users consider the high maintenance cost as the main withdraw of these types of systems.

Component	Composition (%)			
	Agricultural waste	Landfills	Industrial Waste	Desired composition
$CH_4$	50-80	50-80	50-70	>70
$CO_2$	30-50	20-50	30-50	<10
$H_2O$	Saturation	Saturation	Saturation	N/S
$H_2$	0-2	0-5	0-2	N/S
$H_2S$	0.70	0.1	0.8	< 0.01
$NH_3$	Traces	Traces	Traces	N/S
$CO$	0-1	0-1	0-1	N/S
$N_2$	0-1	0-3	0-1	N/S
$O_2$	0-1	0-1	0-1	N/S

(N/S Not specified)

Table 1. Biogas composition. Most of the data from (Carrillo, 2003).

Typically, small scale power plants based on biogas range from 0.1 to 1 MW. This implies a volumetric biogas flows between 60 and 600  $m^3/hr$ . For this small scale application an additional practical consideration arise. Out of the bio-digester or landfill, the biogas gauge pressure is negligible, and due to economical considerations the use of any device to increase pressure should be avoided. Engine suction is the only driving force available to make the biogas to flow from the bio-digester or landfill to the engine. Therefore, the pressure drop across the biogas treatment system should be the least possible.

To address this need, the present document describes the design, manufacturing and testing of a system to reduce  $H_2S$  and  $CO_2$  content to less than 100 ppm and 10%, respectively, from 60 to 600  $m^3/hr$  biogas streams, with minimum pressure drop, for applications in small scale power plants (0.1 to 1 MW) based on internal combustion engines fueled with biogas.

Initially, this document describes and compares the existing alternatives to trap  $H_2S$  and  $CO_2$  from gaseous streams. From this analysis it is concluded that amines treatment is the most appropriate for this application. Since there is no reported data for the  $H_2S$  and  $CO_2$  absorbing capacity of these substances, a method is proposed to measure it by means of a bubbler. This information is used in the design process of biogas treatment system. Details of the manufacturing process are also included. Then, results of the experimental work are reported, and finally, an economical analysis on the use of this type of systems is presented.

## 2. Biogas treatment methods

### 2.1 CO<sub>2</sub> removal from gas streams

CO<sub>2</sub> removal from gas streams has been of great interest, especially in large thermal power plants, due to its greenhouse effect (Romeo et al, 2006). Table 2 compares the different existing technologies.

#### 2.1.1 Absorption

It refers to the process by which one substance, such as a solid or liquid, takes up another substance, such as a liquid or gas, through minute pores or spaces between its molecules. The absorption capacity of the absorber depends on the equilibrium concentrations between gaseous phase and the liquid phase. For diluted concentrations in many gases and in a wide interval of concentrations, the equilibrium relation is given by Henry's Law, which quantifies the gas absorption capacity in the fluid (Cengel & Boles, 2008). A gas absorbing unit should ensure complete contact between the gas and the solvent, in such a way that diffusion occurs at the inter-phase.

#### 2.1.2 Adsorption

It refers to the process by which molecules of a substance, such as a gas or a liquid, collect on the surface of a solid. It differs from absorption, in which a fluid permeates or is dissolved by a liquid or solid (Tondeur & Teng, 2008). It could be physical or chemical. In physical adsorption processes, gas molecules adhere to the surface of the solid adsorbent as a result of the molecules attraction force (Van der Waals Forces). Chemical adsorption involves a chemical reaction. Usually, adsorbents are 12 μm to 120 μm high porosity solid grains, inert to the treated fluid. The most used adsorbents for CO<sub>2</sub> are activated charcoal, silica gel, zeolites and synthetic resins.

#### 2.1.3 Condensation

It is the process of converting a gas into a liquid by reducing temperature and/or increasing pressure. Condensation occurs when partial pressure of the substance in the gas is lower than the vapor pressure of the pure substance at a given temperature.

#### 2.1.4 Membranes

A membrane is a layer of material which serves as a selective barrier between two phases and remains impermeable to specific particles, molecules, or substances when exposed to the action of a driving force. The driving force is the pressure difference between both sides of the membrane. Gas permeability through a membrane is a function of the solubility and diffusivity of the gas into the material of the membrane. Membranes are expensive and their separation efficiencies are low (Ramírez, 2007).

### 2.2 H<sub>2</sub>S removal from gas streams

Table 3 compares the different alternatives reported for H<sub>2</sub>S removal from gas streams (Walsh et al, 1988).

#### 2.2.1 Regenerative processes

It refers to processes where the cleaning reagent, once it becomes saturated, regains its removal capacity through a change in the external conditions.

Method	Option/Alternative	Advantages	Disadvantages
Absorption with water		High efficiency (>97% CH <sub>4</sub> ), Simultaneous removal of H <sub>2</sub> S when H <sub>2</sub> S < 300 cm <sub>3</sub> / m <sup>3</sup> , Capacity is adjustable by changing pressure or temperature, Low CH <sub>4</sub> losses (<2%), tolerant to impurities	Expensive investment and operation, clogging due to bacterial growth, possible foaming, low flexibility toward variation of input gas
Absorption with polyethylene glycol		High efficiency (>97% CH <sub>4</sub> ), Simultaneous removal of organic S components, H <sub>2</sub> S, NH <sub>3</sub> , HCN and H <sub>2</sub> O, Energetic more favorable than water, Regenerative, low CH <sub>4</sub> losses	Expensive investment and operation, difficult operation, Incomplete regeneration when stripping/vacuum (boiling required), reduced operation when dilution of glycol with water
Chemical absorption with amines		High efficiency (>99% CH <sub>4</sub> ), cheap operation, Regenerative, More CO <sub>2</sub> dissolved per unit of volume (compared to water), very low CH <sub>4</sub> losses (<0.1%)	Expensive investment, heat required for regeneration, corrosion, decomposition and poisoning of the amines by O <sub>2</sub> or other chemicals Precipitation of salts, possible foaming
PSA/VSA	Carbon molecular sieves Zeolites Molecular sieves Alumina silicates	Highly efficient (95-98% CH <sub>4</sub> ), H <sub>2</sub> S is removed, low energy use: high pressure, compact technique, also for small capacities, tolerant to impurities	Expensive investment and operation, extensive process control needed, CH <sub>4</sub> losses when malfunctioning of valves
Membrane technology	Gas/gas Gas/liquid	H <sub>2</sub> S and H <sub>2</sub> O are removed, simple construction, Simple operation, high reliability, small gas flows treated without proportional increase of costs <ul style="list-style-type: none"> <li>Gas/gas: removal efficiency: &lt;92% CH<sub>4</sub> (1 step) or &gt; 96% CH<sub>4</sub>, H<sub>2</sub>O is removed</li> <li>Gas/liquid: Removal efficiency: &gt; 96% CH<sub>4</sub>, cheap investment and operation, Pure CO<sub>2</sub> can be obtained</li> </ul>	Low membrane selectivity: compromise between purity of CH <sub>4</sub> and amount of upgraded biogas, multiple steps required (modular system) to reach high purity, CH <sub>4</sub> losses.
Cryogenic separation		90-98% CH <sub>4</sub> can be reached, CO <sub>2</sub> and CH <sub>4</sub> in high purity, low extra energy cost to reach liquid biomethane (LBM)	Expensive investment and operation. CO <sub>2</sub> can remain in the CH <sub>4</sub>
Biological removal		Removal of H <sub>2</sub> S and CO <sub>2</sub> , enrichment of CH <sub>4</sub> , no unwanted end products	Addition of H <sub>2</sub> , experimental - not at large scale

Table 2. Alternatives to remove CO<sub>2</sub> from gas streams (Ryckebosch et al, 2011).

Alternative	Reactions	Range of application	Advantages	Disadvantages
Regenerative	Redox $2Fe^{3+} + H_2S \rightarrow 2Fe^{2+} + S + 2H^+$ $2Fe^{2+} + 0.5O_2 + H_2O \rightarrow 2Fe^{3+} + 2OH^-$	0.5-15 ton/day of H <sub>2</sub> S.	Elemental S is formed High removal efficiency Use of low toxicity solutions	Requires specialized supervision, Low quality product, high pressure problems.
	Amines $2RNH_2 + H_2S \rightarrow (RNH_2)_2S$ $RNH_2 + H_2S \rightarrow RNH_3HS$	H <sub>2</sub> S concentrations higher than 30 ppm and gas flows higher than 10000 m <sup>3</sup> /day.	High removal efficiency for H <sub>2</sub> S and CO <sub>2</sub>	Cost
No regenerative	Ferric oxide $2Fe(OH) + 3H_2S \rightarrow Fe_2S_3 + 6H_2O$ $Fe(OH)_2 + H_2S \rightarrow FeS + 2H_2O$ $2Fe_2S_3 + 3O_2 + 6H_2O \rightarrow 4Fe(OH)_3 + 3S_2$ $2FeS + O_2 + 2H_2O \rightarrow 2Fe(OH) + S_2$	Low scale	Most used. High removal efficiency (>99 %)	Inappropriate for medium scale application Reagent disposal Absorbs CH <sub>4</sub>
	Activated carbon Adsorption	Low scale	Elemental S is formed	
Biological	Solid reagents Zinc oxides $ZnO + H_2S \rightarrow ZnS + H_2O$ Iron oxides $Fe_2O_3 + H_2S \rightarrow 2FeS + S + 3H_2O$ $Fe_2O_4 + H_2S \rightarrow 3FeS + S + 4H_2O$ Sodium nitrite $3H_2S + NaNO_2 \rightarrow NH_3 + 3S + NaOH + XNO_x$ $2NaOH + H_2S \rightarrow Na_2S + 2H_2O$	0.3-500 kg/day of H <sub>2</sub> S.	Low cost high selectivity operational flexibility low CO <sub>2</sub>	Disposal of saturated reagent
	Solvents Caustic wash $CaO + H_2O \rightarrow Cd(OH)_2$ $Ca(OH)_2 + H_2O \rightarrow Cd(CO)_3 + H_2O$ $CaO + H_2S \rightarrow CaS + H_2O$	0-300 ppm H <sub>2</sub> S concentration	Elemental S is formed Low costs Low removal efficiency for H <sub>2</sub> S and CO <sub>2</sub>	Operational difficulties Disposal of saturated solution
	Permanganate solutions $3H_2S + 2KMnO_4 \rightarrow 3S + 2H_2O + 2MnO_2 + 2KOH$	50-20000 kg/day of H <sub>2</sub> S.	Elemental S is formed High removal possible:>97% Low operational costs	Incomplete H <sub>2</sub> S absorption, needs extra-treatment. Require strict control of bacterial conditions.
	Water Adsorption Uses bacteria or microorganisms under controlled ambient conditions Adsorption with filter.			

Table 3. Alternatives for H<sub>2</sub>S removal from gas streams (EPRI, 1992; Freira, 2000; Ryckebosch et al, 2011).



- Amines: Monoethanolamine (MEA), Diethanolamine (DEA) and Methildiethanolamine (MDEA) are organic chemical compounds derived from ammonia as a result of the exchange of one hydrogen molecule by an alkyl radical (Kohl & Nielsen, 1997). The chemical reactions involved in the absorption process of  $H_2S$  are exothermic.
- Redox process: Through this process  $H_2S$  is physically absorbed in water and then, by the use of a chelating ferric solution, elemental sulphur is formed. After saturation, the reagent is regenerated in air (Horikawa & Rossi, 2004). It can be obtained more than 99% of  $H_2S$  absorption. Its main advantage is that it uses low toxicity solutions.
- Ferric oxide: Absorbent material must contain iron in form of oxides, hydrate oxides or hydroxides (Muche & Zimmermann, 1985). Reagent regeneration occurs by exposition to open atmosphere. It is one of the most used methods in biogas treatment. It is very efficient at low scale. However, in high and medium scale applications this method becomes inefficient due to the labor costs involved. Reagent disposal is a serious environmental issue (Ramírez, 2007).
- Activated carbon: Activated carbon, also called activated charcoal or activated coal, is a form of carbon that has been processed to make it extremely porous and thus to have a very large surface area available for adsorption or chemical reactions (Horikawa & Rossi, 2004). It shows affinity to polar substances such as  $H_2O$ ,  $H_2S$ ,  $SO_2$  among many others. In the case of  $H_2S$ , activated carbon absorbs and decomposes it to elemental sulphur (Garetto, 2000). It can be regenerated by temperature at around  $400^\circ C$ . The main disadvantage of this alternative is its affinity for non polar substances such as methane, which makes the alternative inappropriate in pre-combustion processes (Ramírez, 2007).

### 2.2.2 Non regenerative processes

- Zinc oxides: It is based on the reaction of a metal oxide with  $H_2S$  to form the corresponding metal sulfide. Unlike iron oxides, zinc oxides treatment process is irreversible. Absorption reaction occurs at temperatures between  $200^\circ C$  and  $400^\circ C$  (Mabres et al, 2008).
- Iron oxides: It is based on the reaction of a ferric oxide and a triferric oxide with  $H_2S$  to form iron sulfide, sulphur and water. The absorption reaction occurs at temperatures between  $30^\circ C$  to  $60^\circ C$  (Svard, 2004; Steinfeld & Sanderson, 1998).
- Sodium nitrite: It is based in the reaction of  $H_2S$  with a solution of sodium nitrite. It produces a high percentage of  $H_2S$  removal. Its main drawback is the environmentally safe disposition of the saturated solution (Ramírez, 2007).
- Caustic wash: It is an effective method to remove  $H_2S$  y  $CO_2$  from gas streams. Generally, it uses sodium hydroxide and calcium oxide (slaked lime) solutions to promote the chemical reactions showed in Table 3. Disposition of the saturated solutions should be performed according to environmental regulations (Zapata, 1998).
- Permanganate solutions: Potassium permanganate absorbs  $H_2S$  according to the reaction shown in Table 3. It has high removal efficiency but it is costly and requires special treatment of the saturated solutions (Ramírez, 2007).
- Water: It can be used to remove  $H_2S$  y  $CO_2$  by physical adsorption. It is rarely used because water consumption is high and removal efficiency is low for large volumes of biogas (Kapdi et al, 2007).

### 2.2.3 Biological methods

It uses microorganisms under controlled ambient conditions (humidity, oxygen presence, H<sub>2</sub>S presence and liquid bacteria carrier) (Fernández & Montalvo, 1998). Microorganisms are highly sensitivity to changes in pressure, temperature, PH and certain compounds. It requires moderate investments.

### 2.3 Selection

To select a methodology for H<sub>2</sub>S and CO<sub>2</sub> removal it should be taken into account (Treybal, 1996):

- The volumetric flow of biogas
- The amount of H<sub>2</sub>S and CO<sub>2</sub> to be removed and their desired final concentrations
- Availability of environmentally safe disposal methods for the saturated reagents
- Requirements regarding the recovery of valuable components such as S
- Cost

Table 2 and table 3 show that most of the existing methods for H<sub>2</sub>S and CO<sub>2</sub> removal are appropriate for either small scale with low H<sub>2</sub>S and CO<sub>2</sub> concentration or large scale with high pressure drops. Applications with intermediate volumetric flows, high H<sub>2</sub>S and CO<sub>2</sub> content and minimum pressure drop, as in the present case, are atypical. Table 3 shows that for the case of H<sub>2</sub>S, in the present application, the most appropriate methods are amines and iron oxides, which also absorb CO<sub>2</sub>. Iron oxides are meant for small to medium scale applications while amines are meant for large scale applications. Amines have higher H<sub>2</sub>S and CO<sub>2</sub> absorbing efficiency than iron oxides. Both methods have problems with disposition of saturated reagents. Even though amines are costly, they can be regenerated, and depending on the size of the application they could become economically more attractive than iron oxides. Both methods were selected for the present applications. However in this document, results only for the case of amines are reported.

## 3. Determination of the amines H<sub>2</sub>S and CO<sub>2</sub> absorbing capacity

Several works have been developed to model mass transfer in gas-liquid chemical absorbing systems and especially for simultaneous amine H<sub>2</sub>S and CO<sub>2</sub> absorption (Little et al, 1991; Mackowiak et al, 2009; Hoffmann et al, 2007). It has been concluded that the reaction of H<sub>2</sub>S with amines is essentially instantaneous, and that of CO<sub>2</sub> with amine is slow relatively (Qian et al, 2010). Therefore, for amine H<sub>2</sub>S and CO<sub>2</sub> absorption in packed columns mass transfer is not limited by chemical reaction but by the mechanical diffusion or mixing of the gas with the liquid and by the absorbing capacity of the amine.

The Henry's constant defines the capacity of a solvent to absorb physically gas phase components. Under these circumstances of instantaneous reaction it can be extended to chemical absorption. The Henry's law states than under equilibrium conditions (Treybal, 1996; Hvitved, 2002).

$$P_A = y_A \cdot P = H_A \cdot x_A \quad (1)$$

Where:

$P_A$  Partial pressure of component A in gas phase  
 $P$  Total pressure



- $H_A$  Henry's constant of component A  
 $y_A$  Molar concentration of component A in gas phase  
 $x_A$  Mass concentration of component A in liquid phase

It is determined in a temperature and pressure controlled close box by measuring the equilibrium concentration of the component in both gas and liquid phase. Therefore, it requires spectrophotometric or chromatographic analysis to determine component concentration in the liquid phase (Wark, 2000). It has been observed that H<sub>2</sub>S concentrations in amines solutions are highly sensible to pressure and temperature, making spectrophotometric or chromatographic analysis hardly suitable for this application. For this reason literature does not report amines H<sub>2</sub>S and CO<sub>2</sub> absorbing capacity.

As an alternative it was proposed to determine the H<sub>2</sub>S and CO<sub>2</sub> absorbing capacity of the amines by using the gas bubbler setup illustrated in figure 1. This set up looks for a full interaction of the gas stream with the absorbing substance such that it can be assumed thermodynamic equilibrium at the liquid-gas inter phase. Experiments are conducted under standard conditions of pressure and temperature (101 kPa, 25°C). To ensure constant temperature for exothermic or endothermic reactions the set up is placed inside a controlled temperature water bath.

Temperature, pressure, gas flow and degree of water dilution of the absorbing substance are measured. The amount of solution in the bubbler is kept constant in 0.5 L. Table 4 describes the variables measured and their requirements in terms of resolution and range.

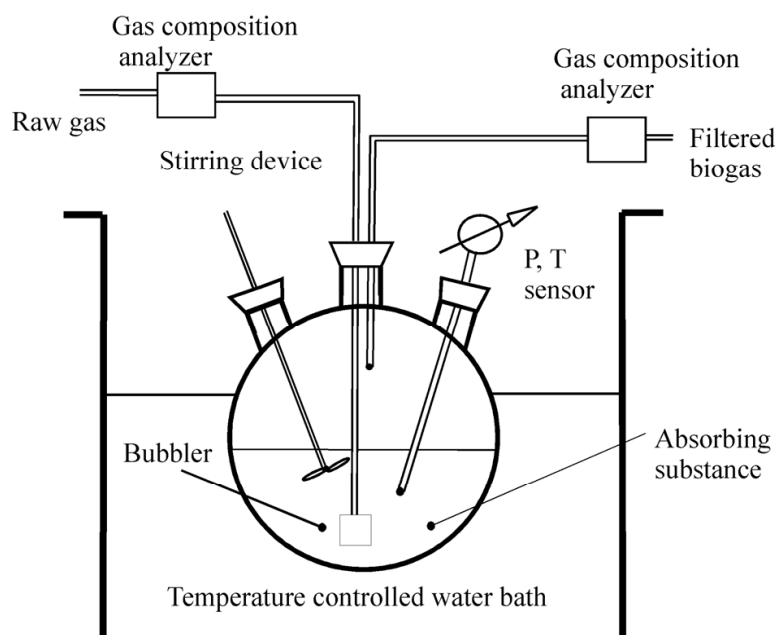

Fig. 1. Setup to determine the absorbing capacity of gas-phase components by liquid phase absorbers in the bubbling method.

Several tests were conducted to verify reproducibility of the method. Figure 2 shows the results obtained in terms of absorbing efficiency vs. time. Absorbing efficiency ( $\eta_f$ ) is defined as:

$$\eta_f = \frac{y_i - y_o}{y_i} \quad (2)$$

Where

$y_i$  H<sub>2</sub>S molar concentration at the inlet  
 $y_o$  H<sub>2</sub>S molar concentration at the outlet

Variable	Resolution	Range
Molar concentration at the inlet and outlet	CO <sub>2</sub> ±3%	CO <sub>2</sub> 0-100%
	CH <sub>4</sub> ±3%	CH <sub>4</sub> 0-100%
	O <sub>2</sub> ±1%	O <sub>2</sub> 0-25%
	H <sub>2</sub> S 35ppm	H <sub>2</sub> S 0-5000ppm
Temperature inside and outside of the bubbler	0.1°C	0-50°C
Volumetric gas flow	0.1 slpm	0-2 slpm
Time	0.1 s	N/A

(N/A Not applies)

Table 4. Variables to be monitored during the determination of the absorbing capacity of gas-phase components by liquid phase absorbers in the bubbling method.

Figure 2 shows that any of the amines solutions can remove 100% of the H<sub>2</sub>S biogas content in the initial part of the test. However it is required at least 50% of amine concentration to remove 100% of the CO<sub>2</sub> biogas content in this first stage.

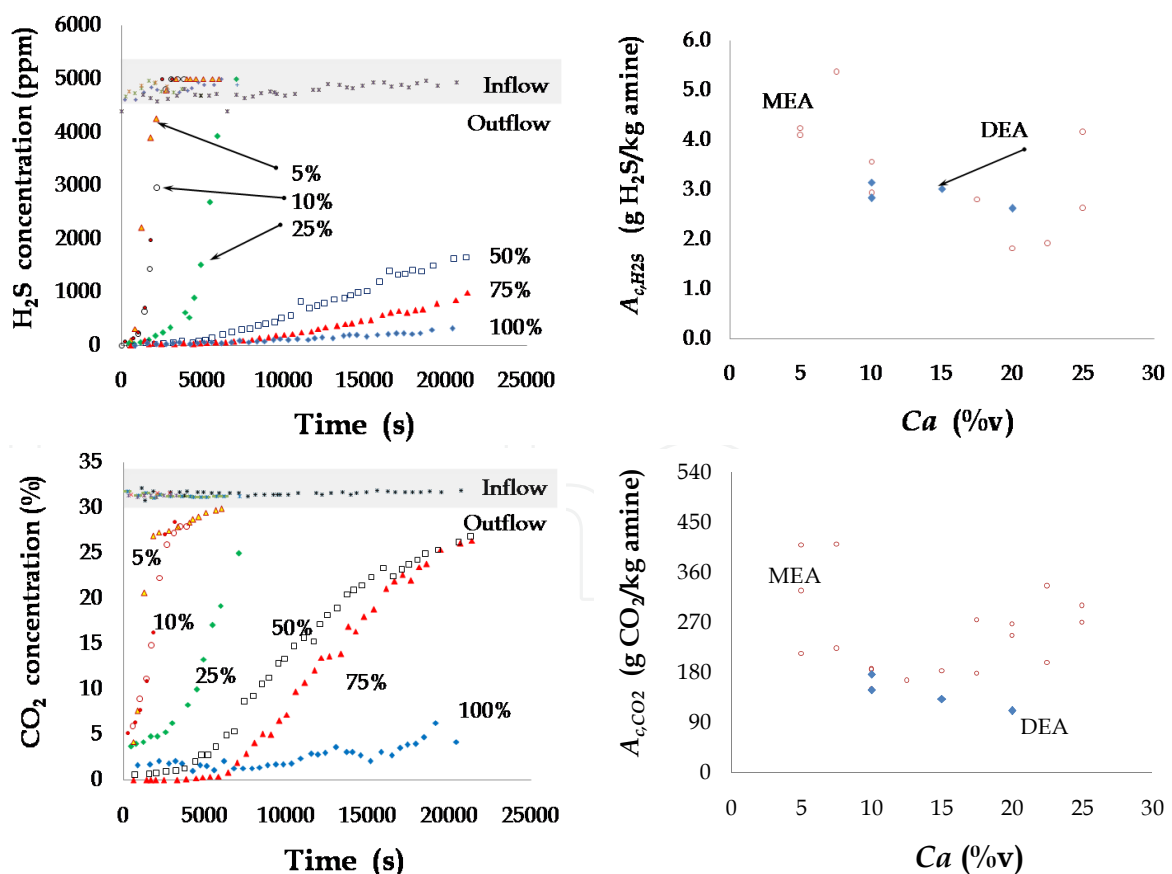

Fig. 2. Evolution of the H<sub>2</sub>S and CO<sub>2</sub> concentration during bubbling tests with MEA (left) and H<sub>2</sub>S and CO<sub>2</sub> absorbing capacity of MEA and DEA as function of their concentration in water (right).

Figure 2 also shows that absorbing efficiencies depend on the degree of saturation of the absorbing substance and on the ratio of the gas flow and the mass of absorbing substance in the bubbler. Additionally, this figure shows that the saturation profiles are similar and have an S type shape. The absorbing capacity under quasi-equilibrium conditions ( $A_{c,e}$ ) is defined as:

$$A_{c,e} = \frac{M}{R^o T m} \int_0^{t_s} (y_o - y_i) Q dt \quad (3)$$

Where:

- $M$  H<sub>2</sub>S or CO<sub>2</sub> molecular weight
- $R^o$  Universal gas constant
- $T$  Absolute temperature
- $m$  Mass of the absorbing substance within the bubbler
- $Q$  Gas volumetric flow measured at standard conditions

Figure 2 shows that MEA and DEA exhibit similar H<sub>2</sub>S and CO<sub>2</sub> absorbing capacities and that they depend on their concentration in water. They exhibit a minimum around 20% and a maximum around 7.5% of volumetric concentration. These results indicate that scrubbing systems should work around 7.5% for applications where H<sub>2</sub>S removal is the main concern or higher than 50% where CO<sub>2</sub> removal is the main objective. However at this high concentration it was observed that amines traces cause corrosion on metallic components, especially when they are made of bronze. Finally, figure 2 shows that on average at 7.5% of MEA or DEA concentration in water their absorbing capacity is of 5.37 and 410.1 g of H<sub>2</sub>S and CO<sub>2</sub>, respectively, per Kg of MEA or DEA.

#### 4. Amine based H<sub>2</sub>S and CO<sub>2</sub> biogas scrubber

Figure 3 illustrates the general configuration of an amine based biogas scrubber. It consists of an absorption column, a desorption column and a water wash scrubber. Initially, raw biogas enters the absorption column where the amine solution removes H<sub>2</sub>S and CO<sub>2</sub>. Then, the biogas passes through the water wash scrubber where amines traces are removed and

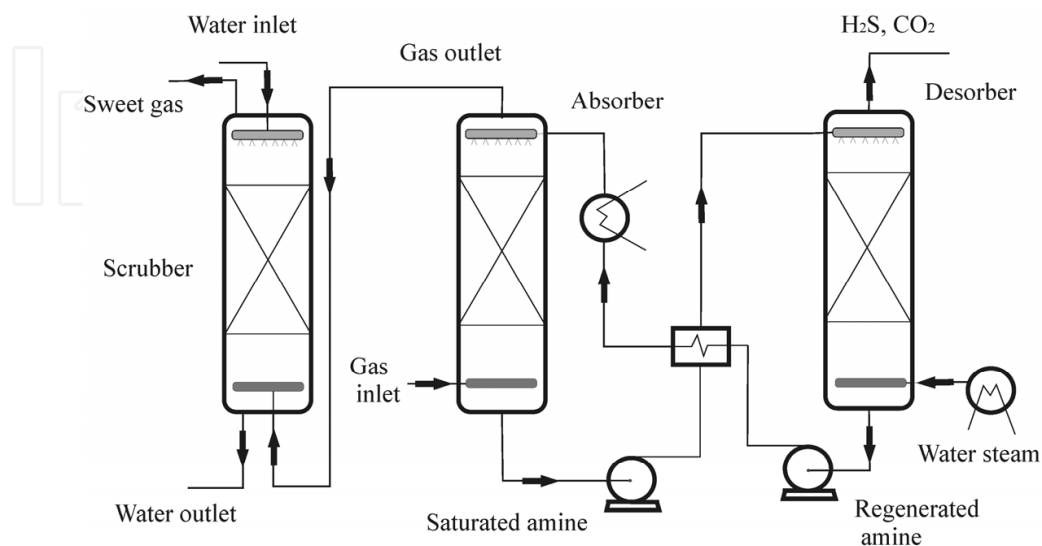

Fig. 3. Illustration of the amine based biogas H<sub>2</sub>S and CO<sub>2</sub> scrubber.

the saturated amine passes through the desorption column where it is regenerated. A heat exchanger is used to cool the regenerated amine before it re-enters the absorption column.

#### 4.1 Absorption column

A H<sub>2</sub>S and CO<sub>2</sub> amine wash biogas scrubber was designed to meet the design parameters specified in section 1 (final H<sub>2</sub>S and CO<sub>2</sub> concentration lower than 100 ppm and 10%, respectively, 60 m<sup>3</sup>/s of biogas flow and minimum pressure drop). It is a counter flow column where amine solution fall down due to gravity and raw biogas flows from the bottom towards the top of the column due to pressure difference. The column is fully packed with inert polyetilene jacks to enhance the contact area between the gas and liquid phases. In addition several disks are incorporated to ensure the uniform distribution of both flows through the column.

The length of the column is designed to obtain the specified final H<sub>2</sub>S and CO<sub>2</sub> concentration and the diameter is designed to meet a minimum pressure drop with the specified gas flow. This procedure is well established and reported in references (Wiley, 2000; Wark, 2000). It requires as data input the results reported in section 3. Table 5 shows the technical characteristics of the absorption column.

Parameter	Column	
	Absorption	Desorption
Material	PVC	SS
Gas flow [m <sup>3</sup> /h]	7.6	8.25
Liquid flow [l/h]	33.3	69
Packing material	Jacks	SS rasching rings
Diámetro [cm]	6.7	6.7
Height [cm]	240	240
Pressuere drop [in.c.a]	0.28	0.2-3
Working reagent	MEA at 10%	H <sub>2</sub> O
Q <sub>r</sub>	230	N/A
η <sub>H<sub>2</sub>S</sub>	98%	N/A
η <sub>CO<sub>2</sub></sub>	75%	N/A
Y <sub>H<sub>2</sub>S</sub> start	>5000 ppm	N/A
Y <sub>H<sub>2</sub>S</sub> final	<100 ppm	N/A
Y <sub>CO<sub>2</sub></sub> start	>40%	N/A
Y <sub>CO<sub>2</sub></sub> final	<10%	N/A

(N/A Not applies)

Table 5. Technical characteristics of the columns used in the amine based biogas scrubber

The absorption column was instrumented with temperature and pressure sensors at the inlet and outlet. Flow meters were used for both the biogas and the liquid phase absorbing substance. Biogas CH<sub>4</sub>, CO<sub>2</sub>, O<sub>2</sub>, and H<sub>2</sub>S concentration were measured at the inlet and outlet of the column by gas detector tubes and electro chemical cells with the technical characteristic specified in Table 4.

The absorption column was evaluated with MEA, DEA, and MDEA. Initially all amines were diluted at 30% (C<sub>a</sub>=30%) in water as recommended by manufacturer (Romeo et al, 2006). However, later on, results from section 3 were incorporated and therefore it was used 7.5% and several other levels of dilution.

Figure 4 shows that pressure drop along the column increases quadratically with the volumetric ratio biogas to amine solution ( $Q_r$ ). For a biogas volumetric flow of 7.6 m<sup>3</sup>/h, the pressure drop is about 3 inches of water column, which is acceptable for this application. This result implies that the final diameter of the column should be 18.8 cm to meet the condition of 60 m<sup>3</sup>/h of biogas flow.

Figure 5 shows the results obtained in terms of H<sub>2</sub>S and CO<sub>2</sub> removing efficiencies ( $\eta_{H_2S}$  and  $\eta_{CO_2}$ ) as function of  $Q_r$ . It shows that the different types of amines produce similar results and that the column with all the amines is able to reach  $\eta_{H_2S} > 98\%$  (final  $Y_{H_2S} = 100$  ppm) for  $Q_r \leq 230$  when  $C_a = 9\%$ . Under this circumstances  $\eta_{CO_2} > 75\%$  (final  $Y_{CO_2} < 10\%$ ). Since MEA is the cheapest amine, it was selected as the working reagent for the absorption column.

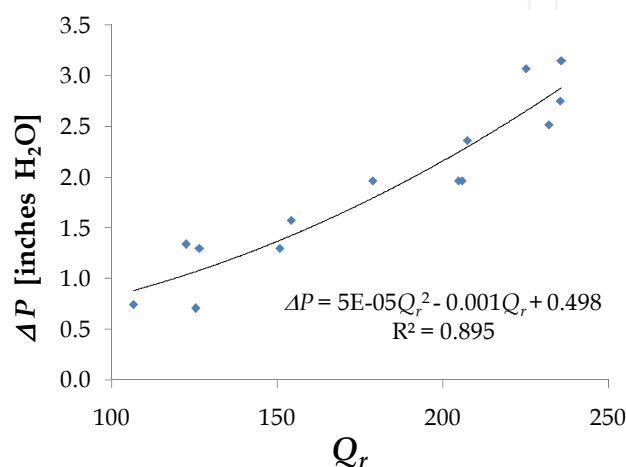

Fig. 4. Pressure drop along the absorption column as function of  $Q_r$ . Amine solution flow was kept constant at 26.5 L/h.

Removing efficiency is a metric to evaluate the performance of the column reaching the final specified concentration. It evaluates under which conditions of  $Q_r$  and  $C_a$  the biogas exits with the final specified concentration. However it does not evaluate the performance of the column in terms of mass transfer. In other words, it does not evaluate the column length ( $L$ ). Amine solution can leave the absorption column unsaturated, which is an undesirable condition since it will increase the total amount of amine required, and therefore the operational costs of the system. Figure 5 shows this effect as a high removing efficiency obtained when the amine solution is passed for a second time along the same column. To quantify this effect, here, it is proposed to define the mass transfer efficiency of the column for component  $i$  ( $\eta_{m,i}$ ) as:

$$\eta_{m,i} = \frac{A_{cr,i}}{A_{c,i}} \quad (4)$$

$$A_{cr,i} = \frac{P}{R_i T} \frac{Y_{i,o} \eta_i}{\rho_a C_a} Q_r \quad (5)$$

Where:

$A_{cr,i}$  Component  $i$  real absorbing capacity of the column

$A_{c,i}$  Component  $i$  amine absorbing capacity as reported in section 3.

$P$  Pressure  
 $T$  Temperature  
 $R_i$  Component  $i$  gas constant  
 $\rho_a$  Amine density

Using this definition, it was found that  $\eta_{m,CO_2}=86\%$  for  $Q_r=230$ . For practical applications this value is acceptable. Higher mass transfer efficiencies can be obtained increasing the length of the column or using more appropriate filling materials. Table 5 summarizes the final operational conditions of the absorption column.

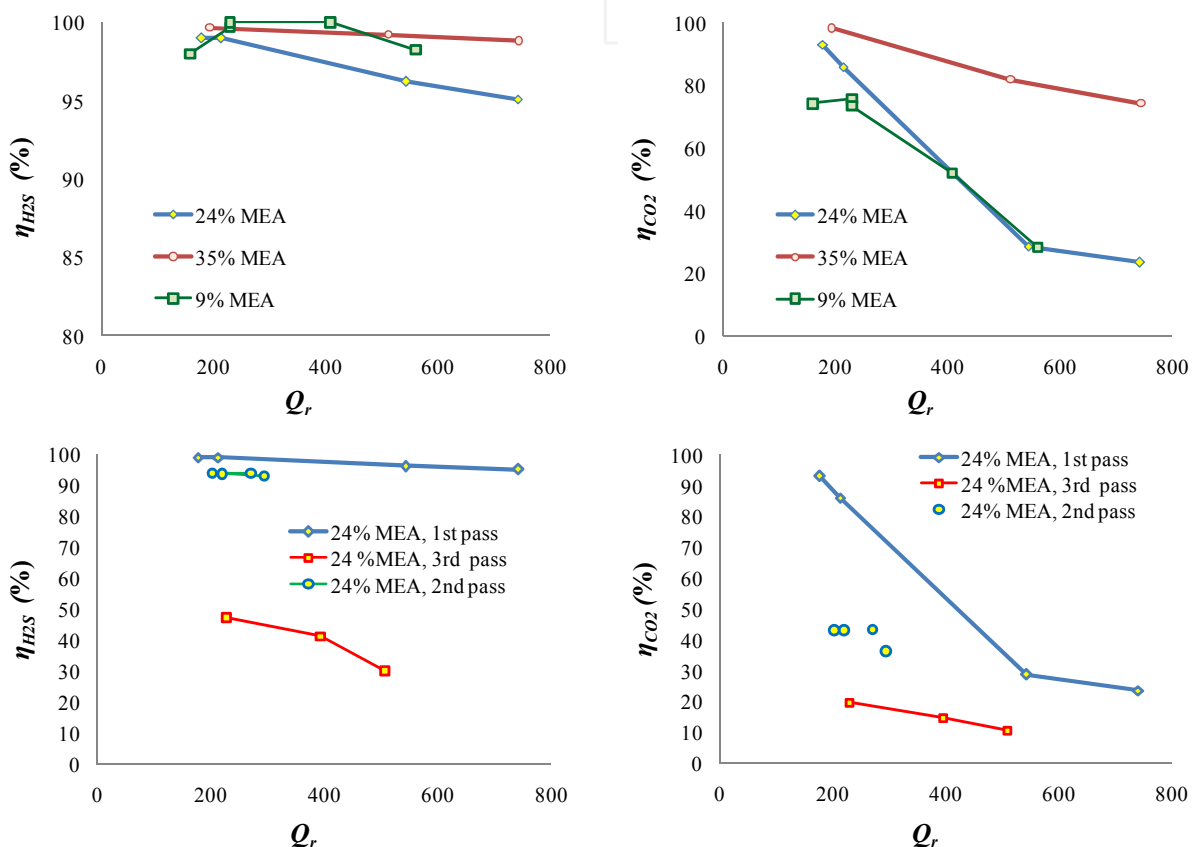

Fig. 5. H<sub>2</sub>S and CO<sub>2</sub> removing efficiencies of the absorption column as function of volumetric ratios of biogas to amine flows for the case of MEA.

#### 4.2 Regenerative column

Amines desorb H<sub>2</sub>S and CO<sub>2</sub> when they are heated up to 120°C at atmospheric pressure (Kolh & Nielsen, 1997). For the present application, this heat addition can be obtained in a counter flow heat exchanger between the amine and the engine exhaust gases. Alternatively, exhaust gases can be used to generate saturated steam and then heat the amines by direct mixing with this steam in a desorbing column. Attending literature recommendations on this matter the latest alternative was chosen (Kolh & Nielsen, 1997).

A desorbing column was designed, manufactured and tested to regenerate amines solutions by mixing with steam. Figure 3 illustrates its operation. Preheated saturated amine solution fall down through the desorption column due to gravity while steam moves in counter-flow due to pressure difference. Under steady conditions the energy requirements for the



desorption column are the heats of desorption, sensible and latent for the amine solution and for the steam. They are influenced by pressure and flow rates (Chakravarti et al, 2001). For larger scale applications the  $\text{CO}_2$  and  $\text{H}_2\text{S}$  -rich vapor stream that leaves the desorption column can be passed through a reflux condenser where  $\text{H}_2\text{O}$  is partially condensed,  $\text{CO}_2$  sequestered and  $\text{H}_2\text{S}$  recovered for industrial applications.

On the other side, regenerated amine solutions should be cooled before reentering the absorption column because temperature reduces the amine absorbing capacity. For this purpose it is used a heat exchanger between regenerated amine and saturated amine coming out of the absorption column. The regenerative column was made of 2.5 inches stainless steel pipe to avoid corrosive problems. It was fully packed with stainless steel rashing rings to increase the contact area between the amine solution and the steam. Additionally it was thermally isolated with a heavy layer of fiberglass to avoid heat losses. Table 5 shows its technical specification.

It was instrumented with temperature and pressure sensors at the inlet, middle and outlet of the column. Amines solution flow rate was measured. Steam flow was adjusted to obtain maximum temperature. However, since the column is an open atmosphere system, the maximum temperature that can be reached is the water boiling temperature ( $98^\circ\text{C}$  for atmospheric pressure of 85 KPa).

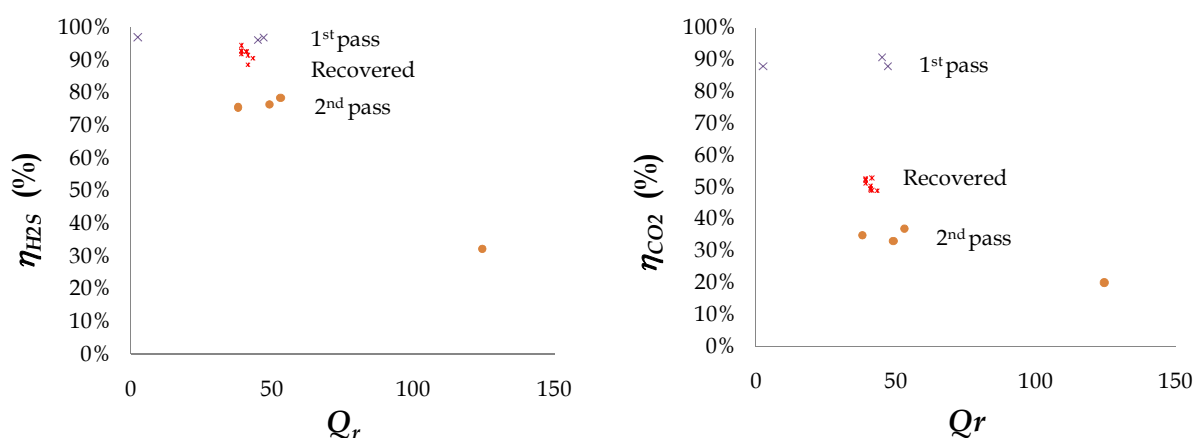

Fig. 6.  $\text{H}_2\text{S}$  and  $\text{CO}_2$  removing efficiencies of the absorption column as function of volumetric ratios of biogas to amine flows for the case of regenerated MEA at 15% of volumetric concentration.

Fully saturated amines solutions were passed through the desorption column and collected at the bottom. Then they were cooled and used again in the absorption column under the same conditions as they were initially saturated ( $Q_r=230$ ). Figure 6 shows results obtained in terms of removing efficiency. It shows that the  $\text{H}_2\text{S}$  removing efficiencies change from 98% to 95% when the amine is regenerated. Similarly, it changes from 87% to 50% for the case of  $\text{CO}_2$ . Even though these results are encouraging, they are still partial results in the sense that further work is required to ensure maximum amines regeneration before evaluating its removing efficiency. Literature reports that amines can be regenerated 25 times before being degraded.

## 5. Economical evaluation

An economical analysis was performed to evaluate the economical feasibility of implementing this type of amine based  $\text{H}_2\text{S}$  and  $\text{CO}_2$  biogas scrubber. It was assumed a

horizon time of 10 years and a scale of power generation of 1 kW in a typical farm in Mexico without any governmental subsidy or benefits from green bonuses. It was also assumed an annual interest rate of 5%. From the engine manufacturer experience it is known that oil change period is reduced from 1000 to 250 hr and that overhaul maintenance is reduced from 84000 hr to 24000 hr when using biogas without any treatment. Additionally it was considered in the analysis that power output increases  $\approx 30\%$  when using the amine treatment system. Under these circumstances it was found that electric power generation from biogas currently has a cost of 0.024 USD/kW-h and that this cost can be reduced up to 61% (0.015 USD/kW-h) when the amine based H<sub>2</sub>S and CO<sub>2</sub> biogas scrubber is included. Then, it was found that the turnover of the initial investment is of about 1 year.

## 6. Conclusions

Recently, a new approach for electric power generation has been emerging as a consequence of the need of replacing traditional hydrocarbon fuels by renewable energies. It consists of inter-connecting thousands of small and medium scale electric plants powered by renewable energy sources to the national or regional electric grid. In this case, typical small scale (0.1 to 1 MW) plants consisting of internal combustion engines coupled to electric generator and fueled by biogas become as one of the most attractive alternatives because of its very low cost, high benefit-cost ratio and very high positive impact on the environment. However, the use of biogas to generate electricity has been limited by its high content of H<sub>2</sub>S (1800-5000 ppm) and CO<sub>2</sub> ( $\sim 40\%$ ). The high content of H<sub>2</sub>S corrodes important components of the engine like the combustion chamber, bronze gears and the exhaust system. CO<sub>2</sub> presence reduces the energy density of the fuel and therefore the power output of the system. Therefore there is a need for a system to reduce H<sub>2</sub>S and CO<sub>2</sub> biogas content to less than 100 ppm and 10%, respectively, from 60 to 600 m<sup>3</sup>/hr biogas streams.

To address this need, several existing alternatives to remove H<sub>2</sub>S and CO<sub>2</sub> content from gaseous streams were compared in terms of their range of applicability, removing efficiency, pressure drop across the system, feasibility of reagent regeneration and availability of methods environmentally safe for final disposal of saturated reagents. It was found that the existing methods are appropriate for either small scale applications with low H<sub>2</sub>S and CO<sub>2</sub> concentration or large scale with high pressure drops. Applications with intermediate volumetric flows, high H<sub>2</sub>S and CO<sub>2</sub> content and minimum pressure drop, as required in the present case, are atypical. It was also found that the most appropriate methods for the present application are amines and iron oxides, which absorb both H<sub>2</sub>S and CO<sub>2</sub>. Iron oxides are meant for small to medium scale applications while amines are meant for large scale applications. Amines have higher H<sub>2</sub>S and CO<sub>2</sub> absorbing efficiencies than iron oxides. Both methods have problems with disposition of saturated reagents. Even though amines are costly, they can be regenerated, and depending on the size of the application they could become economically more attractive than iron oxides. Both methods were selected for the present applications. However in this document, only results for the case of amines were reported.

To design the scrubbing system based on amines it is necessary to know its H<sub>2</sub>S and CO<sub>2</sub> absorbing capacity. Since there is not reported data on this regard, it was proposed a method to measure it by means of a bubbler. It is an experimental setup where the gas stream passes through a fixed amount of the absorbing substance until it becomes saturated. Results showed that MEA and DEA exhibit similar H<sub>2</sub>S and CO<sub>2</sub> absorbing capacities and

that they depend on their concentration in water. They exhibit a minimum around 20% of volumetric concentration. These results indicate that scrubbing systems should work around 7.5% for applications where H<sub>2</sub>S removal is the main concern or higher than 50% where CO<sub>2</sub> removal is the main objective. On average at 7.5% of MEA or DEA concentration in water their absorbing capacity is of 5.37 and 410.1 g of H<sub>2</sub>S and CO<sub>2</sub>, respectively, per Kg of MEA or DEA.

Using this information, it was designed an absorbing gas-liquid column to reduce the H<sub>2</sub>S and CO<sub>2</sub> content to 100 ppm and 10%, respectively, from ~60 m<sup>3</sup>/hr biogas streams, with negligible pressures drop. The manufactured column was tested with three different types of amines: MEA, DEA, and MDMEA. Results permitted to identify the ratio of amines to biogas flow ( $Q_r=230$ ) required to obtain the highest H<sub>2</sub>S and CO<sub>2</sub> removing efficiencies (98% and 75% respectively) along with the highest mass transfer in the column (86%) when it is used MEA at 9%.

Then, an amine regenerative system was designed, manufactured and tested. Exhaust hot gases from the engine were used to heat the diluted amine up to 95°C. Tests showed that the H<sub>2</sub>S removing efficiencies change from 98% to 95% when the amine is regenerated. Similarly, it changes from 87% to 50% for the case of CO<sub>2</sub>. Even though these results are encouraging, they are still partial results in the sense that further work is required to ensure maximum amines regeneration before evaluating its removing efficiencies.

Finally, an economical analysis was performed assuming a horizon time of 10 years and a scale of power generation of 1 kW in a typical farm in Mexico without any governmental subsidy or benefits from green bonuses. It was found that under these circumstances, electric power generation from biogas has a cost of 0.024 USD/kW-h. This cost can be reduced up to 61% (0.015 USD/kW-h) when the amine based H<sub>2</sub>S and CO<sub>2</sub> biogas scrubber is included). Then, it was found that the turnover of the initial investment is of about 1 year.

## 7. Acknowledgments

This project was partially financed by the Mexican council of science and technology-COMECYT and the company MOPESA. The authors also express their gratitude to engineer Jessica Garzon for their contributions to this project.

## 8. References

- Carrillo, L. (2003). *Microbiología Agrícola*, Universidad Nacional de Salta, ISBN 987-9381-16-5, Salta, Argentina
- Cengel, Y. & Boles, A. (2008). *Thermodynamics. An Engineering Approach* (6th Ed.), McGraw-Hill, ISBN 9780073305370, New York, New York, USA
- Chakravarti, S.; Gupta, A. & Hunek, B. (2001). Advanced Technology for the Capture of Carbon Dioxide, *First National Conference on Carbon Sequestration*, Washington, DC, USA, May 15-17, 2001
- Montes, M.; Legorburu, I. & Garetto, T. (2008). *Eliminación de Emisiones Atmosféricas de COVs por catálisis y adsorción*, CYTED, ISBN 978-84-96023-64-2, Madrid, Spain
- Davis, W. (2000). *Air Pollution Engineering Manual*, Wiley Interscience Publication, ISBN 978-0-471-33333-3
- DePriest, W. & Van Laar, J. (1992). *Engineering Evaluation of PRENFLO-based Integrated-gasification-combined-cycle (IGCC) power plant designs*, Chicago, Illinois, USA

- Fernández, E. & Montalvo, S. (1998). *Métodos económicos y ecológicamente viables para purificar gases contaminantes*, 26.04.2011, Available from: <http://www.bvsde.ops-oms.org/bvsaidis/caliaire/peru/cubpca004.pdf>
- Gosh, D. P. (2007). Wet H<sub>2</sub>S Cracking Problem in Oil Refinery Processes - Material selection and operation control issues, *The 2007 Tri-Service Corrosion Conference*, December 3-7, 2007, Denver, Colorado, USA
- Harasimowicz, M.; Orluk, P.; Zakrzewska-Trznadel, G. & Chmielewski, A. (2007). Application of polyimide membranes for biogas purification and enrichment, *Journal of Hazardous Materials*, Vol. 144, No. 3, June 2007, pp. 698-702, ISSN 0304-3894
- Horikawa, M.S.; Rossi, M.L.; Gimenes, M.L.; Costa, C.M.M. & da Silva, M.G.C. (2004). Chemical Absorption of H<sub>2</sub>S for biogas purification, *Brazilian Journal of Chemical Engineering*, Vol. 21, No. 3, July-September 2004, pp. 415-422
- Hvitved, J. (2002). *Sewer Processes: Microbial and Chemical Process Engineering of Sewer Networks*, CRC Press, ISBN 1-56676-926-4, Florida, USA
- Kapdi, S.S., Vijay, V.K., Rajesh, S.K. & Prasad, R. (2007). Biogas Scrubbing, Compression and Storage: Perspective and Prospectus in Indian Context, *Renewable Energy*, Vol. 30, No. 8, July 2005, pp. 1195-1202, ISSN 0960-1481
- Kolh, A. & Nielsen, R. (1997). *Gas Purification*, Gulf Publishing Company, ISBN 978-0-88415-220-0, Houston, Texas, USA
- Hoffmann, A.; Mackowiak, J. F.; Górak, A.; Haas, M.; Löning, J.-M.; Runowski, T. & Hallenberger, K. (2007). Standardization of mass transfer measurements: A basis for the description of absorption processes, *Chemical Engineering Research and Design*, Vol. 85, A1, (January 2007), pp. 40-49
- Littel, R. J.; Filmer, B.; Versteeg, G. F. & Van Swaaij, W. P. M. (1991). Modelling of simultaneous absorption of H<sub>2</sub>S and CO<sub>2</sub> in alkanolamine solutions: the Influence of parallel and consecutive reversible reactions and the coupled diffusion of ionic species, *Chemical Engineering Science*, Vol. 46, No. 9, (1991), pp. 2303-2313
- Mabres, A., Freire, D. & Bevilacqua, L. (2003). Eliminación de Sulfuro de Hidrógeno en Emisiones Gaseosas Atmosféricas, *5tas. Jornadas de Preservación de Agua, Aire y Suelo en la Ind. del Petróleo y del Gas*, Buenos Aires, Argentina, November 5-7, 2003
- Mackowiak, J. F.; Górak, A.; Kenig, E. Y. (2009). Modelling of combined direct-contact condensation and reactive absorption in packed columns, *Chemical Engineering Journal*, No. 146, (2009), pp. 362-369
- Marchaim, U. (1992). *Biogas processes for sustainable development*, FAO, ISBN 92-5-103126-6, Rome, Italy
- Muche, H. & Zimmermann, H. (1985). *The Purification of Biogas*, ISBN 3-528-02015-6, Munich, Germany
- Pointon, K. & Langan, M. (2002). *Distributed Power Generation Using Biogas Fuelled Microturbines*, 26.04.2011, Available from: [www.berr.gov.uk/files/file14934.pdf](http://www.berr.gov.uk/files/file14934.pdf)
- Qian, Z.; Xu, L.; Li, Z.; Li, H. & Guo, K. (2010). Selective Absorption of H<sub>2</sub>S from a Gas Mixture with CO<sub>2</sub> by Aqueous N-Methyldiethanolamine in a Rotating Packed Bed, *Industrial & Engineering Chemistry Research*, Vol. 49, No. 16, (May 2010), pp. 6196-6203
- Ramírez, M. (2007). *Viabilidad de un proceso para la eliminación conjunta de H<sub>2</sub>S y NH<sub>3</sub> contenido en efluentes gaseosos*. Universidad de Cádiz, Cádiz, Spain.

- Romeo, L. M.; Escosa, J. & Bolea, I. (2006). *Postcombustion CO<sub>2</sub> sequestration*, Universidad de Zaragoza, Zaragoza, Spain
- Steinfeld, G., & Sanderson, R. (1998). *Landfill Gas Cleanup for Carbonate Fuel Cell Power Generation*, National Renewable Energy Laboratory, Morgantown, West Virginia, USA
- Svärd, T. (2004). *Adsorption of Hydrogen Sulfide at low temperature*, Lund University, Lund, Sweden
- Tondeur, D. & Teng, F. (2008). Carbon capture and storage for greenhouse effect mitigation. In *Future Energy: Improved, sustainable and clean options for our planet*, T. M. Letcher (Ed.), pp. 305-330, Elsevier, ISBN 978-0-08-054808-1, China
- Treybal, R. E. (1996). *Operaciones de Transferencia de Masa* (2nd ed.), Mc Graw Hill, ISBN 968-6046-34-8, Mexico
- Walsh, J.; Ross, C.; Smith, M.; Harper, S. & Wilkins, W. (1988). *Biogas Utilization Handbook*, Georgia Tech Research Institute, ISBN 0962464740, Atlanta, Georgia, USA
- Wark, K. & Warner, C.F. (1981). *Air Pollution: Its Origin and Control*, Harper and Row Publishers, New York, New York, USA
- www.textoscientificos.com. (December 2nd, 2005). *Usos del biogas*, April 5th, 2011, Available from: <http://www.textoscientificos.com/energia/biogas/usos>

IntechOpen



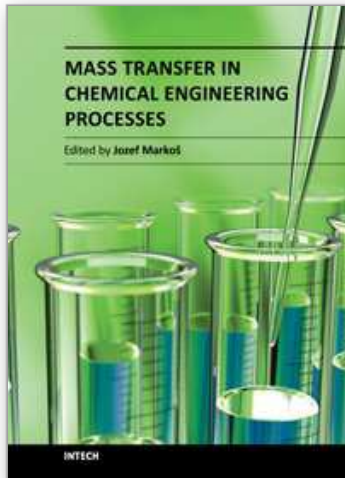

## **Mass Transfer in Chemical Engineering Processes**

Edited by Dr. Jozef Marko

ISBN 978-953-307-619-5

Hard cover, 306 pages

**Publisher** InTech

**Published online** 04, November, 2011

**Published in print edition** November, 2011

This book offers several solutions or approaches in solving mass transfer problems for different practical chemical engineering applications: measurements of the diffusion coefficients, estimation of the mass transfer coefficients, mass transfer limitation in separation processes like drying, extractions, absorption, membrane processes, mass transfer in the microbial fuel cell design, and problems of the mass transfer coupled with the heterogeneous combustion. I believe this book can provide its readers with interesting ideas and inspirations or direct solutions of their particular problems.

### **How to reference**

In order to correctly reference this scholarly work, feel free to copy and paste the following:

J.I. Huertas, N. Giraldo, and S. Izquierdo (2011). Removal of H<sub>2</sub>S and CO<sub>2</sub> from Biogas by Amine Absorption, Mass Transfer in Chemical Engineering Processes, Dr. Jozef Marko (Ed.), ISBN: 978-953-307-619-5, InTech, Available from: <http://www.intechopen.com/books/mass-transfer-in-chemical-engineering-processes/removal-of-h2s-and-co2-from-biogas-by-amine-absorption>

**INTECH**  
open science | open minds

### **InTech Europe**

University Campus STeP Ri  
Slavka Krautzeka 83/A  
51000 Rijeka, Croatia  
Phone: +385 (51) 770 447  
Fax: +385 (51) 686 166  
[www.intechopen.com](http://www.intechopen.com)

### **InTech China**

Unit 405, Office Block, Hotel Equatorial Shanghai  
No.65, Yan An Road (West), Shanghai, 200040, China  
中国上海市延安西路65号上海国际贵都大饭店办公楼405单元  
Phone: +86-21-62489820  
Fax: +86-21-62489821



© 2011 The Author(s). Licensee IntechOpen. This is an open access article distributed under the terms of the [Creative Commons Attribution 3.0 License](#), which permits unrestricted use, distribution, and reproduction in any medium, provided the original work is properly cited.

IntechOpen

IntechOpen