

We are IntechOpen, the world's leading publisher of Open Access books Built by scientists, for scientists

4,800

Open access books available

122,000

International authors and editors

135M

Downloads

Our authors are among the

154

Countries delivered to

TOP 1%

most cited scientists

12.2%

Contributors from top 500 universities



WEB OF SCIENCE™

Selection of our books indexed in the Book Citation Index
in Web of Science™ Core Collection (BKCI)

Interested in publishing with us?
Contact book.department@intechopen.com

Numbers displayed above are based on latest data collected.

For more information visit www.intechopen.com



Autonomous Mobile Robot Emmy III

Cláudio Rodrigo Torres, Jair Minoro Abe,
 Germano Lambert-Torres and João Inácio da Silva Filho
*Universidade Metodista de São Paulo,
 University of São Paulo and Paulista University – UNIP,
 Federal University of Itajubá, Universidade Santa Cecília – UNISANTA
 Brazil*

1. Introduction

In this work we present a description of the Emmy III robot architecture [1], [2], [3], [4] and, also, a summary of the previous projects which have led to the Emmy III robot building [5], [6], [7], [8], [9]. These robots are part of a project of applying the Paraconsistent Annotated Evidential Logic $E\tau$ [12] which allows manipulating concepts like fuzziness, inconsistencies and para-completeness.

The Emmy III robot is designed to achieve a set point in an environment which is divided into coordinates. The Emmy III robot may be considered as a system which is divided into three other subsystems: the planning subsystem, the sensing subsystem and the mechanical subsystem.

The planning subsystem is responsible for generating the sequence of movements the robot must perform to achieve a set point. The sensing subsystem has the objective of informing the planning subsystem the position of obstacles; the mechanical subsystem is the robot itself, it means, the mobile mechanical platform which carries all devices that come from the other subsystems. This platform must also perform the sequence of movements borne by the planning subsystem.

It is observed that the planning subsystem and the sensing subsystem have already been implemented, but the mechanical subsystem has not been implemented yet.

The sensing subsystem uses the Paraconsistent Artificial Neural Networks - PANN [2], [3]. PANN is a new type of Artificial Neural Networks - ANNs based on Paraconsistent Annotated Evidential Logic $E\tau$. In the next paragraph we introduce the main basic concepts of the Logic $E\tau$, as well as some terminologies.

2. Paraconsistent annotated evidential logic $E\tau$

Generally, Paraconsistent Logics is a new kind of logics that allows contradictions without trivialization. A branch of it, the Paraconsistent Annotated Evidential Logic $E\tau$, which will be employed in this work, also deals with the concept of fuzziness. Its language consists of propositions in the usual sense p together with annotation constants: (μ, λ) where $\mu, \lambda \in [0, 1]$ (real unitary interval). Thus an atomic formula of the Logic $E\tau$ is of the form $p(\mu, \lambda)$ which can be intuitively read: the favorable evidence expressed by p is μ and the contrary evidence expressed by p is λ . A detailed feature on the subject is found in [12].

The Favorable Evidence Degree (μ) is a value that represents the favorable evidence in which the sentence is true; this value is between 0 and 1.

The Contrary Evidence Degree (λ) is a value that represents the contrary evidence in which the sentence is true; this value is between 0 and 1.

Through the Favorable and Contrary Degrees it is possible to represent the four extreme logic states, as shown in the figure 1.

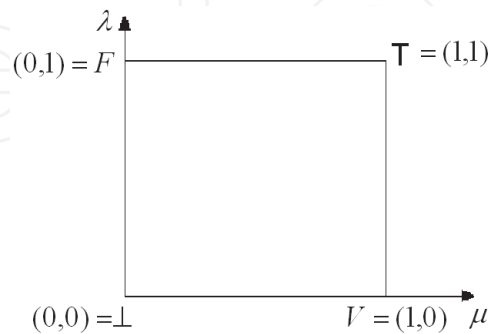

Fig. 1. The extreme logic states

The four extreme logic states are:

- True (V)
- False (F)
- Paracomplete (\perp)
- Inconsistent (T)

In [6] it is proposed the Para-analyzer Algorithm. By this algorithm it is also possible to represent the non-extreme logic state. The figure 2 shows this.

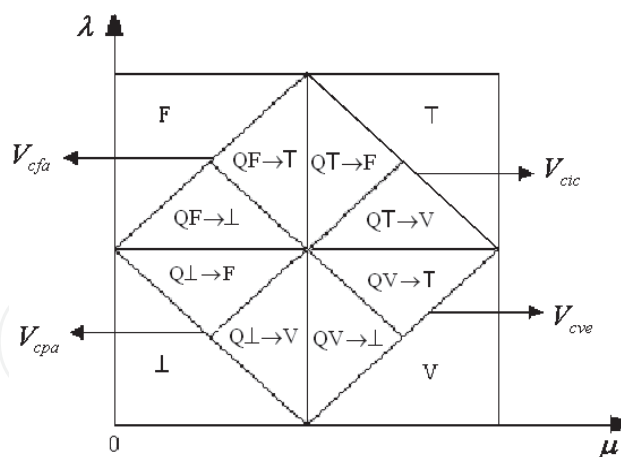

Fig. 2. The non-extreme logic states

The eight non-extreme logic states are:

- Quasi-true tending to Inconsistent - $QV \rightarrow T$
- Quasi-true tending to Paracomplete - $QV \rightarrow \perp$
- Quasi-false tending to Inconsistent - $QF \rightarrow T$
- Quasi-false tending to Paracomplete - $QF \rightarrow \perp$
- Quasi-inconsistent tending to True - $QT \rightarrow V$
- Quasi-inconsistent tending to False - $QT \rightarrow F$

- Quasi-paracomplete tending to True - $Q\perp \rightarrow V$
- Quasi-paracomplete tending to False - $Q\perp \rightarrow F$

It is also defined the Uncertainty Degree: $G_{un}(\mu, \lambda) = \mu + \lambda - 1$ and the Certainty Degree: $G_{ce}(\mu, \lambda) = \mu - \lambda$ ($0 \leq \mu, \lambda \leq 1$)

Some additional control values are:

- V_{cic} = maximum value of uncertainty control
- V_{cve} = maximum value of certainty control
- V_{cpa} = minimum value of uncertainty control
- V_{cfa} = minimum value of certainty control

It is described the proposed sensing system in the next section.

3. Paraconsistent artificial neural network

The artificial neural network of the sensing subsystem is composed of two types of cells: Analytic Paraconsistent Artificial Neural Cell - CNAPa, and Passage Paraconsistent Artificial Neural Cell - CNAPpa. The cells are described as it follows:

3.1 Analytic paraconsistent artificial neural cell - CNAPa

The Analytic Paraconsistent Artificial Neural Cell - CNAPa has two inputs (μ_{RA} and μ_{RB}) and two outputs (S1 and S2). There are also two configuration parameter inputs (Ftct and Ftc). The figure 3 shows the graphic representation of this cell.

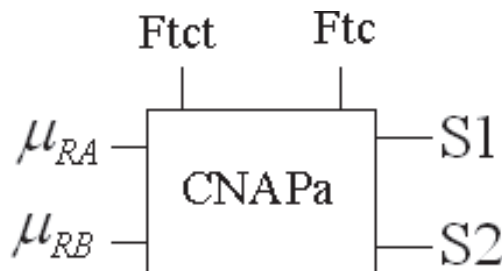

Fig. 3. Graphic representation of the Analytic Paraconsistent Artificial Neural Cell

The input evidence degrees are:

- μ_{RA} , such as: $0 \leq \mu_{RA} \leq 1$
- μ_{RB} , such as: $0 \leq \mu_{RB} \leq 1$

There are also two control values:

- Contradiction Tolerance Factor - Ftct, such as: $0 \leq Ftct \leq 1$
- Certainty Tolerance Factor - Ftc, such as: $0 \leq Ftc \leq 1$

The Analytic Paraconsistent Artificial Neural Cell - CNAPa has two outputs. The out-put 1 (S1) is the Resultant Evidence Degree - μ_E .

- μ_E , such as: $0 \leq \mu_E \leq 1$
- The output 2 (S2) is the Resultant Evidence Interval - ϕ_E .
- ϕ_E , such as: $0 \leq \phi_E \leq 1$

The Analytic Paraconsistent Artificial Neural Cell calculates the maximum value of certainty - V_{cve} , the minimum value of certainty control - V_{cfa} , the maximum value of uncertainty control - V_{cic} , and the minimum value of uncertainty control - V_{cpa} , by this way:

$$V_{cve} = \frac{1 + Ft_c}{2} \quad (1)$$

$$V_{cfa} = \frac{1 - Ft_c}{2} \quad (2)$$

$$V_{cic} = \frac{1 + Ft_{ct}}{2} \quad (3)$$

$$V_{cpa} = \frac{1 - Ft_{ct}}{2} \quad (4)$$

The Resultant Evidence Degree - μ_E , is determined as:

$$\mu_E = \frac{G_c + 1}{2} \quad (5)$$

As $G_c = \mu - \lambda$, we can say that:

$$\mu_E = \frac{\mu - \lambda + 1}{2} \quad (6)$$

It is called as Certainty Interval (φ) the Certainty Degree interval that can be modified without changing the Uncertainty Degree value. This value is determined as:

$$\varphi = 1 - |G_{ct}| \quad (7)$$

3.2 Passage Paraconsistent Artificial Neural Cell - CNAPpa

The Passage Paraconsistent Artificial Neural Cell - CNAPpa has one input (μ), one out-put (S1) and one parameter control in-put (Ftc). The figure 4 shows the graphic representation of CNAPpa.

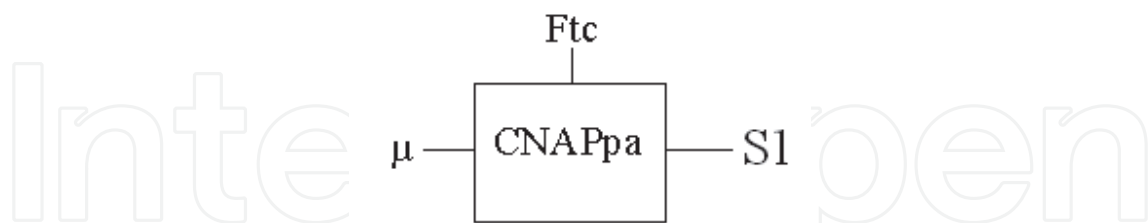

Fig. 4. Graphic representation of the Passage Paraconsistent Artificial Neural Cell

- The in-put is the Favorable Evidence Degree (μ).
- μ , such as: $0 \leq \mu \leq 1$
- The value for the output S1 is the same as for the in-put μ . But, the out-put value may be limited through the parameter control in-put Ftc.

The CNAPpa calculates the maximum value of certainty - V_{cve} and the minimum value of certainty control - V_{cfa} by the equations (1) and (2). And it also determines the Resultant Evidence Degree - μ_E , by the equation (6). For this, λ is considered as the following:

$$\lambda = 1 - \mu \quad (8)$$

The output $S1$ assumes the same value as in the in-put μ when the following situation is true:

- $[(V_{cve} \leq \mu_E) \text{ or } (\mu_E \leq V_{cfa})]$
- Otherwise, $S1$ is 0,5.

4. Autonomous mobile robot Emmy I

The robot Emmy I was the first application of the Paraconsistent Evidential Logics in robotics [8], [9]. The Emmy I robot project finished in 1999 and its results have led to the construction of the Emmy II robot and to the Emmy III project itself.

The Emmy I has two ultra-sonic sensors: one determines the favorable evidence degree and the other determines the contrary evidence degree. The Emmy I controller, named as Paracontrol, allows the Emmy I to act conveniently in "special" situations, as when there is contradictory datum: one sensor may detect an obstacle in front of the robot (for example, a wall) while the other detects the presence of no obstacles (for example, it may be in direction to an opened door). In a situation like that Emmy may stop and turn 45° to the most free direction. Then, if in a new measurement, there is no inconsistency, the robot may take another decision, for example, to go ahead.

The Emmy I robot consists of a circular mobile platform of aluminum with a 30 cm diameter and being 60 cm tall. Its main device is the Paracontrol controller. While moving into a non-structured environment, the Emmy robot gets information about presence/absence of obstacles using a sonar system called Parasonic [17]. The figure 5 shows the autonomous mobile robot Emmy.



Fig. 5. The autonomous mobile robot Emmy

The Paracontrol [18] is an electronic materialization of the Para-analyzer algorithm [9] [19]. Basically, it is an electronic circuitry which treats logic signals in a context of logic $\epsilon\tau$. Such circuitry compares the logic value entries and determines the logic values output. Favorable evidence and contrary evidence degrees are represented by voltage. Operational amplifiers determine the Certainty and the Uncertainty degrees. The Paracontrol comprises both, analogical and digital systems, and it can be externally adjusted by applying positive and negative voltages. As there are 12 logic states in the Para-analyzer algorithm, the Paracontrol can take 12 different decisions.

Parasonic is an electronic circuitry that the Emmy I robot uses to detect obstacles in its path. Parasonic converts distances from obstacles into electric signals of continuous voltage, ranging from 0 to 5 volts. Parasonic is basically composed of two ultrasonic sensors, type POLAROID 6500, controlled by an 8051 microcontroller. The microcontroller is programmed to carry out the synchronization between the measurements of the two sensors and the change of the distance into electric voltage.

Parasonic generates the favorable evidence degree value (μ) and the contrary evidence degree value (λ). They make a continuous voltage which ranges from 0 to 5 volts. Paracontrol receives these signals from Parasonic. The figure 6 shows the basic structure of the Emmy robot.

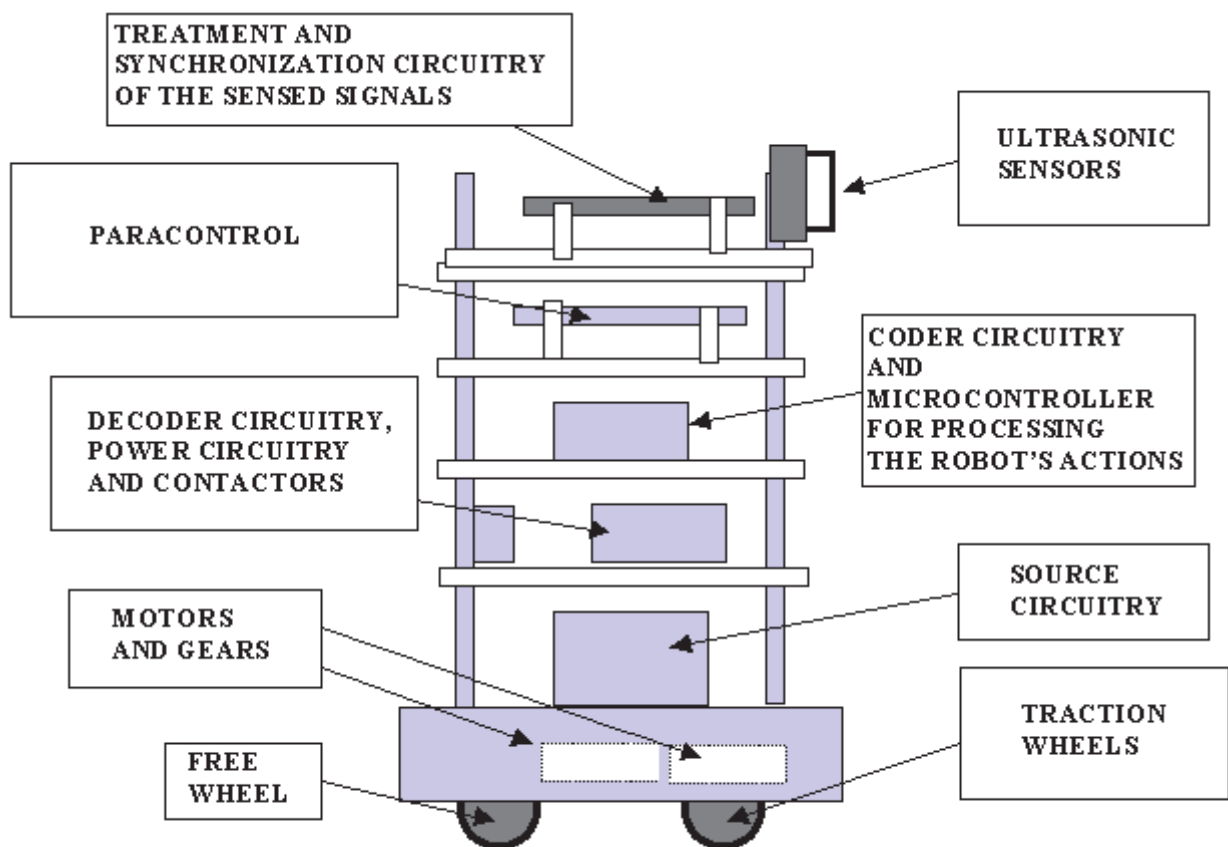

Fig. 6. Basic structure of Emmy robot

In the figure 7 can be seen the main components of the Emmy robot.

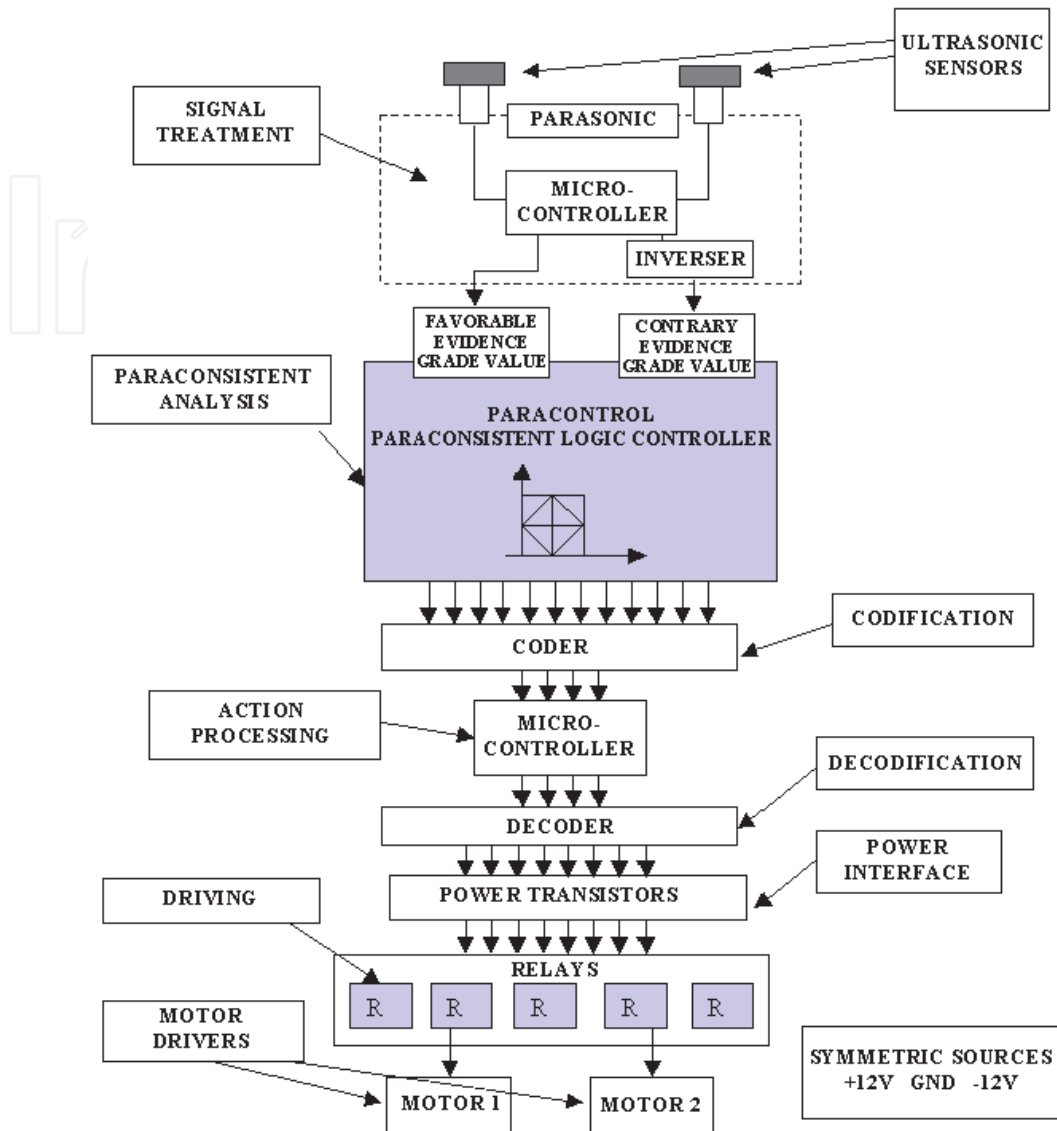

Fig. 7. Main components of the Emmy robot

The description of the Emmy robot components is the following.

- Ultrasonic sensors: two ultrasonic sensors are responsible for emitting ultrasonic waves and for detecting the return of them.
- Signal treatment: in Parasonic there is a microcontroller which sends to the sensors a signal that makes them emit ultrasonic waves. When the ultrasonic waves return, the sensors send the microcontroller a signal. The microcontroller measures the time lasted between the sending and the returning of the ultrasonic waves. So, the microcontroller is able to determine the distance between the sensors and the obstacles in front of them. Paracontrol generates a continuous voltage ranging from 0 to 5 volt, it must be proportional to the distance between the sensor and the obstacle. This signal is considered the favorable evidence degree value on the proposition "The front of the robot is free". In the same way the Paracontrol generates a continuous voltage ranging from 5 to 0 volt, it must be related to the contrary evidence degree.

- Paraconsistent analysis: the Paracontrol makes the logical analysis of the signals according to the logic Et.
- Codification: the coding circuitry changes a 12-digit word to a code of 4 digits.
- Action processing: a microcontroller processes the 4 digit code generated by the coding circuitry, determining the sequence of relays which must be actuated for the robot to perform the right movement.
- Decodification: the decoding circuitry changes a 4-digit word into a code of 12 digits.
- Power interface: transistors amplify the signals of the 12-digit-word generated by the decoding circuitry. Then the signals can actuate on the relays.
- Driving: relays are responsible for actuating the DC motors M1 and M2.
- Motor driver: two DC motors are responsible for moving the robot.
- Sources: two batteries composing a ± 12 volt symmetric source feed the Emmy robot electric circuitries.

5. Autonomous mobile robot Emmy II

The Emmy II robot is an improvement of the Emmy I robot. It is an autonomous mobile robot which is able to avoid obstacles while it is moving in any environment.

The platform used to assemble the Emmy II robot is approximately 23cm high and has a diameter of 25cm. The Emmy II robot main components are a microcontroller from the 8051 family, two sonar ranging module (sensors) and two DC motors. The figure 8 shows the Emmy II basic structure.

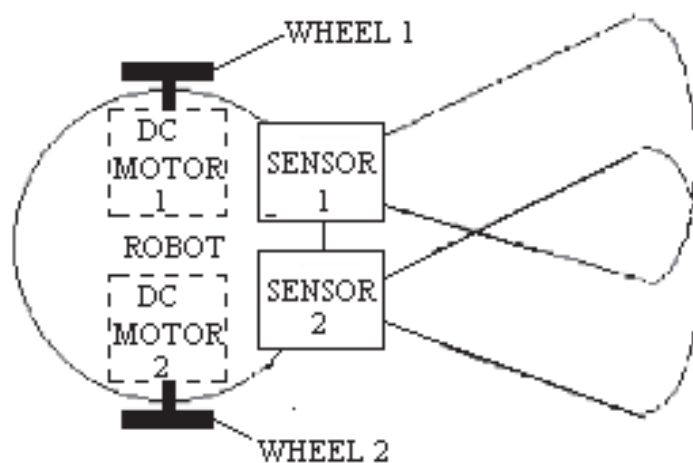

Fig. 8. The Emmy II basic structure

The Emmy II controller system uses six logic states instead of 12 logic states which are used in the Emmy I controller. Moreover, it may present some commands that do not exist in the Emmy I robot:

1. Velocity control: the Emmy II controller allows the robot to brake, turn and accelerate "in a smooth way", what is not possible in the Emmy I robot.
2. The Emmy II controller allows the backward motion. In some situations the robot may move backward or turn around with a fixed wheel having the other spinning around backward. There are not these types of movements in the Emmy I robot.

It can be seen in the figure 9 a simplified block representation of the Emmy II robot.

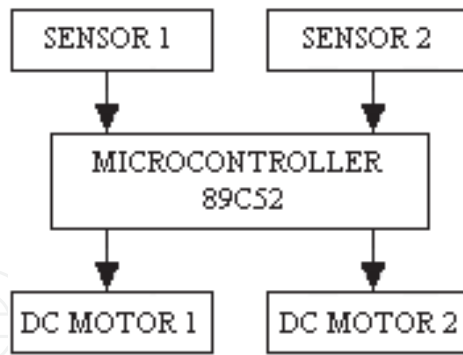

Fig. 9. Emmy II block representation

The figure 10 shows a picture of the Emmy II robot

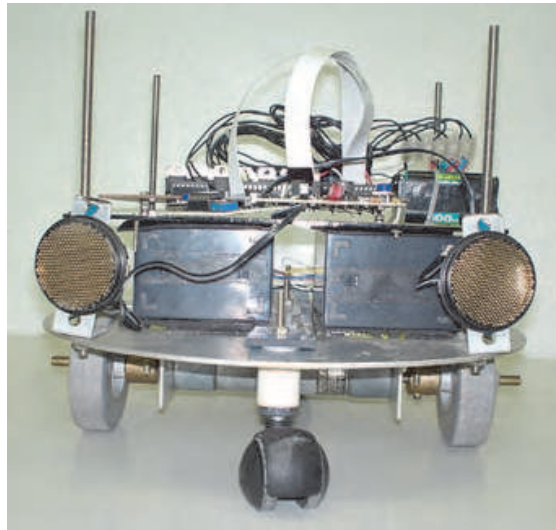

Fig. 10. The front part of the Emmy II robot

It is shown in the figure 11 the lower part of the Emmy II robot.

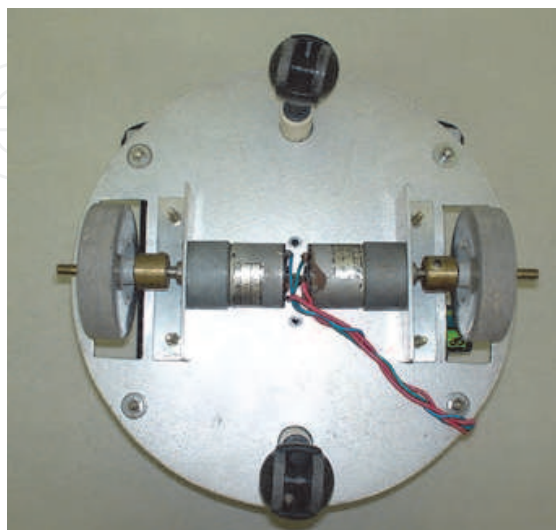

Fig. 11. The lower part of the Emmy II robot

The sonar ranging modules are responsible for verifying whether there is any obstacle in front of the robot or not. The signals generated by the sonar ranging modules are sent to the microcontroller. These signals are used to determine the favorable evidence degree (μ) and the contrary evidence degree (λ) on the proposition "There is no obstacle in front of the robot". The favorable and contrary evidence degrees are used to determine the robot movements.

The Emmy II possible movements are the following:

- Robot goes ahead. DC motors 1 and 2 are supplied for spinning around forward.
- Robot goes back. DC motors 1 and 2 are supplied for spinning around backward.
- Robot turns right. Just DC motor 1 is supplied for spinning around forward.
- Robot turns left. Just DC motor 2 is supplied for spinning around forward.
- Robot turns right. Just DC motor 2 is supplied for spinning around backward.
- Robot turns left. Just DC motor 1 is supplied for spinning around backward.

The signal generated by the sensor 1 is considered the favorable evidence degree and the signal generated by the sensor 2 is considered the contrary evidence degree for the proposition "There is no obstacle in front of the robot". When there is an obstacle near the sensor 1, the favorable evidence degree is low and when there is an obstacle far from the sensor 1, the favorable evidence degree is high. Otherwise, when there is an obstacle near the sensor 2, the contrary evidence degree is high and when there is an obstacle far from the sensor 2, the contrary evidence degree is low. The Emmy II controller decision of which movement the robot should perform is based on the reticulated showed in the figure 12.

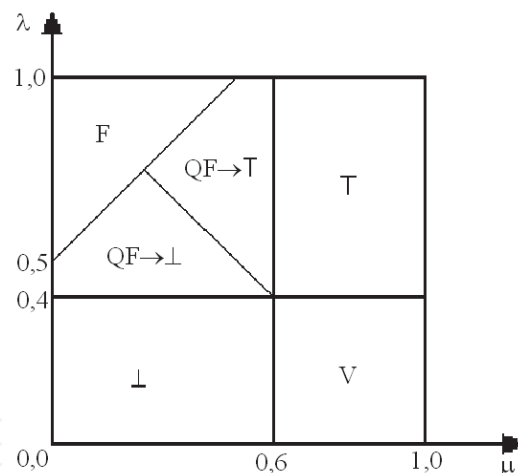

Fig. 12. Lattice of Emmy II controller

The decision for each logic state is the following:

- V state: Robot goes ahead.
- F state: Robot goes back.
- \perp state: Robot turns right.
- T state: Robot turns left.
- $QF \rightarrow \perp$ state: Robot turns right.
- $QF \rightarrow T$ state: Robot turns left.

The justification for each decision is the following:

When the logic state is true (V), it means that the front of the robot is free. So, the robot can go ahead.

In the inconsistency (T), μ and λ are high (i.e., belong to T region). It means that the sensor 1 is far from an obstacle and the sensor 2 is near an obstacle, so the left side is more free than the right side. Then, the behavior should be to turn left by supplying only the DC motor 2 for spinning around forward and keeping the DC motor 1 stopped.

When the Paracompleteness (\perp) is detected, μ and λ are low. It means that the sensor 1 is near an obstacle and the sensor 2 is far from an obstacle, so the right side is more free than the left side. Then, the behavior should be to turn right by supplying only the DC motor 1 for spinning around forward and keeping the DC motor 2 stopped.

In the false state (F) there are obstacles near the front of the robot. Therefore the robot should go back.

In the $QF \rightarrow T$ state, the front of the robot is obstructed but the obstacle is not so near as in the false state and the left side is a little bit more free than the right side. So, in this case, the robot should turn left by supplying only the DC motor 1 for spinning around backward and keeping the DC motor 2 stopped.

In the $QF \rightarrow \perp$ state, the front of the robot is obstructed but the obstacle is not so near as in the false state and the right side is a little bit freer than the left side. So, in this case, the robot should turn right by supplying only the DC motor 2 for spinning around backward and keeping the DC motor 1 stopped.

5.1 Tests

Aiming to verify Emmy II robot functionally, it has been performed 4 tests. Basically, counting how many collisions there were while the robot moved in an environment as showed in figure 13 composed the tests.

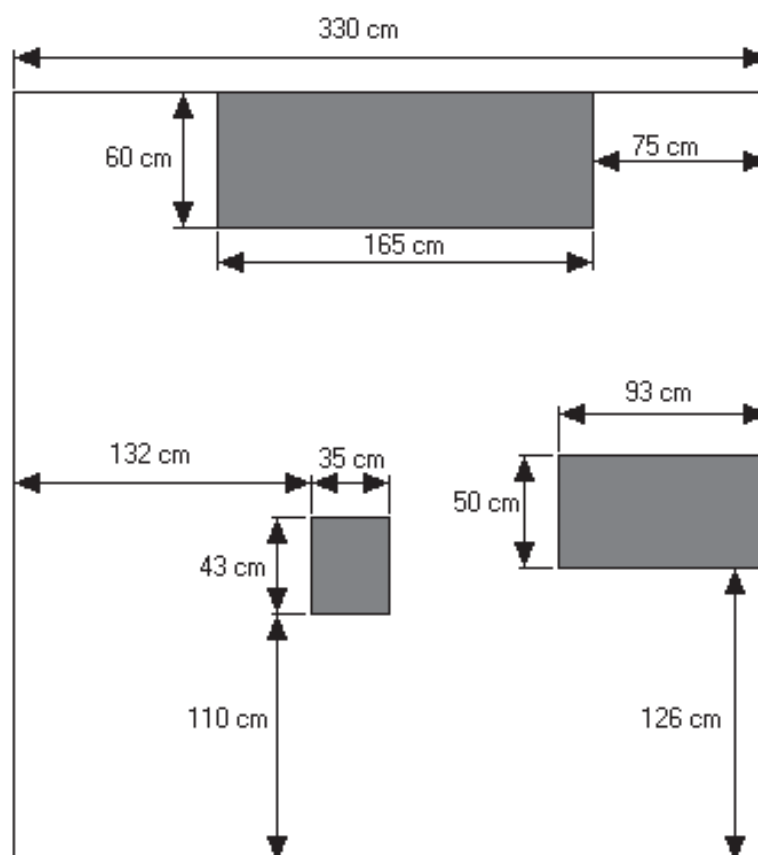

Fig. 13. Environment used to perform the Emmy II tests

The time duration and results for each test have been the following:

Test 1: Duration: 3 minutes and 50 seconds. Result: 13 collisions.

Test 2: Duration: 3 minutes and 10 seconds. Result: 7 collisions.

Test 3: Duration: 3 minutes and 30 seconds. Result: 10 collisions.

Test 4: Duration: 2 minutes and 45 seconds. Result: 10 collisions.

The sonar ranging modules used in the Emmy II robot can't detect obstacles closer than 7,5 cm. The sonar ranging modules transmit sonar pulses and wait for them to return (echo) so that it can determine the distance between the sonar ranging modules and the obstacles; however, sometimes the echo doesn't return, because it reflects to another direction. These are the main causes for the robot collisions:

Test 1: Collisions: 13.

Collisions caused by echo reflection: 4.

Collisions caused by too near obstacles: 9.

Test 2: Collisions: 7.

Collisions caused by echo reflection: 2.

Collisions caused by too near obstacles: 5.

Test 3: Collisions: 10.

Collisions caused by echo reflection: 5.

Collisions caused by too near obstacles: 5.

Test 4: Collisions: 10.

Collisions caused by echo reflection: 4.

Collisions caused by too near obstacles: 6.

There is another robot collision possibility when the robot is going back. As there is no sonar ranging module behind the robot, it may collide.

6. Autonomous mobile robot Emmy III

The aim of the Emmy III autonomous mobile robot is to move from an origin to an end, both predetermined in a non-structured environment. The Emmy III controller considers the environment around the robot divided into cells [15] and a planning subsystem gives the sequence of cells the robot must follow to reach the end cell. These ideas have been applied in [20], [21]. The robot must avoid cells that are supposed to be occupied. A sensing subsystem detects the cells which are occupied. The sensing subsystem uses Paraconsistent Annotated Logic to handle information captured by the sensors. The Emmy III structure is composed of a sensing subsystem, a planning subsystem and a mechanical subsystem as described in the follow.

Sensing subsystem - The environment around the robot is considered as a set of cells. The sensing subsystem has to determine the cells which have obstacles in. But the information captured by the sensors always has an inherent imprecision, which leads to an uncertainty regarding to the actual situation of the cells. In order to manipulate the inconsistent information, the sensing subsystem is based on ParaconsistentAnnotated Evidential Logic $E\tau$, which captures the information generated by the sensors using the favorable and contrary evidence degrees.

Planning subsystem - The planning subsystem determines a path linking an initial point to an end point in a non-structured environment. For this, the environment around the robot is divided into cells and the planning subsystem gives the sequence of cells that the robot must follow to reach the end cell successfully.

Mechanical subsystem - The Emmy III mechanical part must perform the schedule determined by the planning subsystem. For this, the mechanical subsystem must know the cell occupied by the robot, therefore, a monitoring position makes part of this construction. For each cell that the robot reaches, the possible error of position should be considered.

6.1 Sensing subsystem

The objective of the sensing subsystem is to inform the other robot components about the obstacle position. The proposed sensing subsystem has as its main part Paraconsistent Neural Network [13], [14]. This artificial neural network is based on the Paraconsistent Evidential Logics - Et.

The sensing subsystem is a set of electronic components and softwares which are responsible for analyzing the environment around the robot and detecting the obstacle positions. After that, it must inform the other components of the robot the position of the obstacles.

The sensing subsystem may get information from any type of sensor.

In [15] it is presented a method of robot perception and the world's modeling which uses a probabilistic tessellated representation of spatial information called the Occupancy Grid. It is proposed in the chapter a similar method, but instead of using probabilistic representation, it is used Paraconsistent Annotated Evidential Logic Et.

The proposed sensing subsystem aims to generate a Favorable Evidence Degree for each environment position. The Favorable Evidence Degree is related to the sentence: there is an obstacle in the analyzed position.

The sensing subsystem is divided into two parts. The first part is responsible for receiving the data from the sensors and sending information to the second part of the system. The second part is Paraconsistent Artificial Neural Network itself. Figure 14 shows this idea.

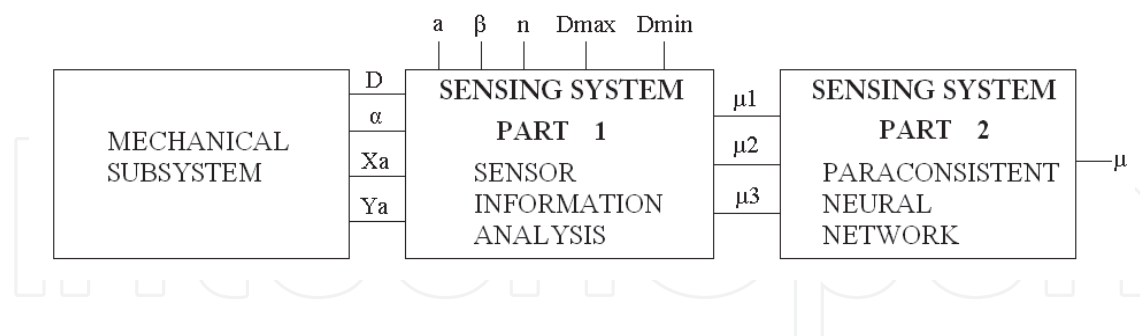

Fig. 14. Representation of the sensing system

The proposed sensing subsystem is prepared to receive data from ultrasonic sensors. The robot sensors are on the mechanical subsystem. So, this subsystem must treat the data generated by the sensors and send information to the first part of the sensing subsystem. The data the mechanical subsystem must send to the first part of the sensing subsystem are: D , α , X_a and Y_a .

- The distance between the sensor and the obstacle (D).
- The angle between the horizontal axis of the environment and the direction to the front of the sensor (α). Figure 15 shows the angle α .

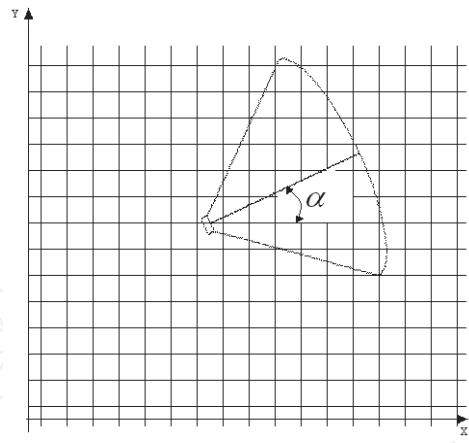

Fig. 15. Angle α

c. The coordinate occupied by the robot (X_a, Y_a).

In the first part of the sensing subsystem there are also some configuration parameters, which are:

a. The distance between the environment coordinates (a); it is indicated in the figure 16.

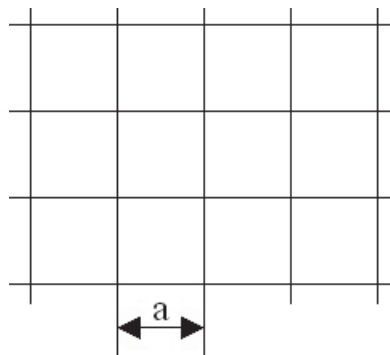

Fig. 16. Distance between coordinates

b. The angle of the ultrasonic sensor conical field of view (β). Figure 17 shows this.

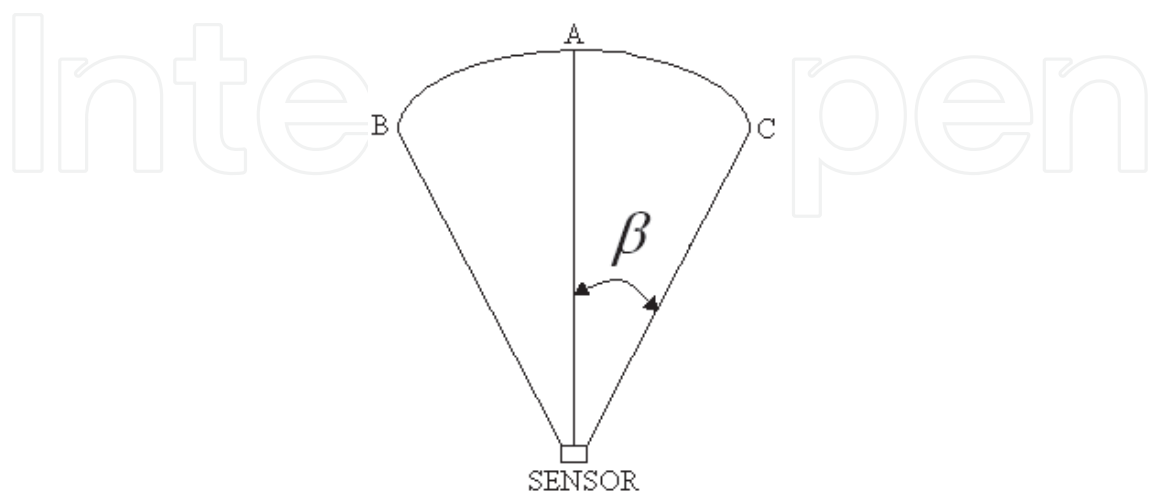

Fig. 17. Ultrasonic sensor conical field of view (β)

- c. The number of positions on the arc BC, shown in the figure 17, considered by the system (n).
- d. The maximum distance measured by the sensor; the system considers it (D_{max}).
- e. The minimum distance measured by the sensor; the system considers it (D_{min}).

The first part of the sensing system generates three Favorable Evidence Degree, μ_1 , μ_2 and μ_3 .

The Favorable Evidence Degree μ_1 is related to the distance between the sensor and the obstacle. The nearer the obstacle is from the sensor, the bigger μ_1 value is.

The Favorable Evidence Degree μ_2 is related to the coordinate position on the arc BC shown in the figure 17. As the analyzed coordinate is near from the point A, the μ_2 value must be the biggest. And as the analyzed coordinate is near from the points B or C, the μ_2 value must be the smallest. The inspiration for this idea comes from [16] which says that the probability for the obstacle be near from the point A is high. And this probability decreases as we analyze the region near from the points B and C.

Eventually, the Favorable Evidence Degree μ_3 is the previous value of the coordinate Favorable Evidence Degree.

6.1.1 Paraconsistent artificial neural network architecture

In the figure 18, it is shown Paraconsistent Artificial Neural Network - PANN architecture for the sensing subsystem.

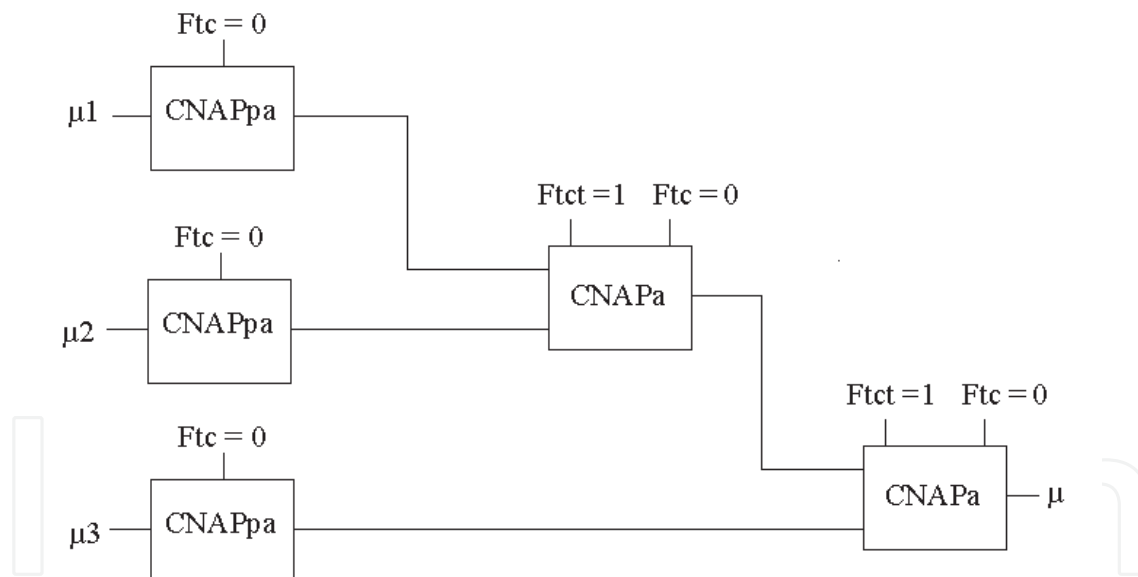

Fig. 18. Chosen Paraconsistent Neural Network Architecture for sensing system.

The PANN output μ is Favorable Evidence Degree for the analyzed position. There is a database which has recorded the μ for each analyzed position. The robot considers each position as a cell.

6.2 Results of the sensing subsystem

The sensing subsystem has been tested by simulating its inputs and analyzing the database generated. The database stores Favorable Evidence Degree in each environment position

analyzed. It is shown here the result of three tests. The information from one ultrasonic sensor was considered as the Sensing System inputs.

6.2.1 First test

The configuration parameters of this test have been the following. The distance between the environment coordinates (a): 10. The angle of the ultrasonic sensor conical field of view (β): 30. The number of positions on the arc of the sensor conical field of view considered by the system (n): 10. The maximum distance measured by the sensor; the system considers it (Dmax): 800. The minimum distance measured by the sensor; the system considers it (Dmin): 8.

The mechanical subsystem treats the data from the sensors and generates the sensing subsystem inputs. It has been needed to simulate the sensing subsystem inputs because the mechanical subsystem has not been implemented yet.

Thus, the simulated sensing subsystem data have been the ones described in the follow. The distance between the sensor and the obstacle (D): 200. The angle between the horizontal axis of the environment and the direction to the front of the sensor (α): 30. The coordinate where the robot is (X_a, Y_a): (0, 0).

It has been simulated the first measuring of the sensor, then, μ_3 has been initially 0.

It is shown in the figure 19 the representation of the coordinates in which sensing system considered to have obstacles in. Summarizing, the figure 10 is a graphical representation of the database generated by sensing subsystem.

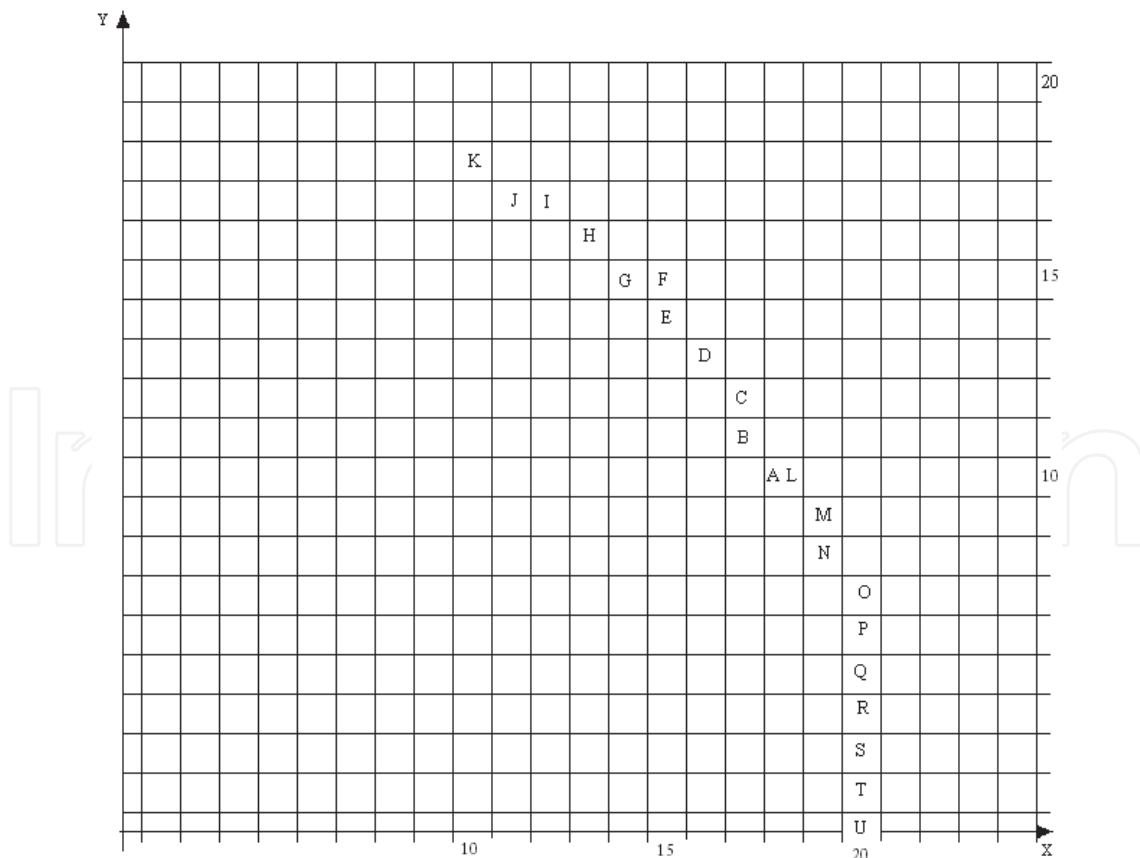

Fig. 19. The graphical representation of the database generated by the first test of sensing subsystem

| Coordinate | μ |
|------------|-------|
| A (18,10) | 0.438 |
| B (17,11) | 0.413 |
| C (17,12) | 0.388 |
| D (16,13) | 0.363 |
| E (15,14) | 0.338 |
| F (15,15) | 0.313 |
| G (14,15) | 0.288 |
| H (13,16) | 0.263 |
| I (12,17) | 0.238 |
| J (11,17) | 0.213 |
| K (10,18) | 0.188 |
| L (18,10) | 0.413 |
| M (19,9) | 0.388 |
| N (19,8) | 0.363 |
| O (20,7) | 0.338 |
| P (20,6) | 0.313 |
| Q (20,5) | 0.288 |
| R (20,4) | 0.263 |
| S (20,3) | 0.238 |
| T (20,2) | 0.213 |
| U (20,0) | 0.188 |

Table 1. Results of the first test.

The analyzed coordinates and their Favorable Evidence Degree are shown in the table 1.

6.2.2 Second test

The configuration parameters of this test have been the same as the ones from the first test. The simulated sensing subsystem data have been the ones described in the follow. The distance between the sensor and the obstacle (D): 400. The angle between the horizontal axis of the environment and the direction to the front of the sensor (α): 45. The coordinate where the robot is (X_a, Y_a): (0, 0).

It has been simulated the first measuring of the sensor, then, μ_3 was initially 0.

It is shown in the figure 20 the graphical representation of the database generated by the sensing subsystem.

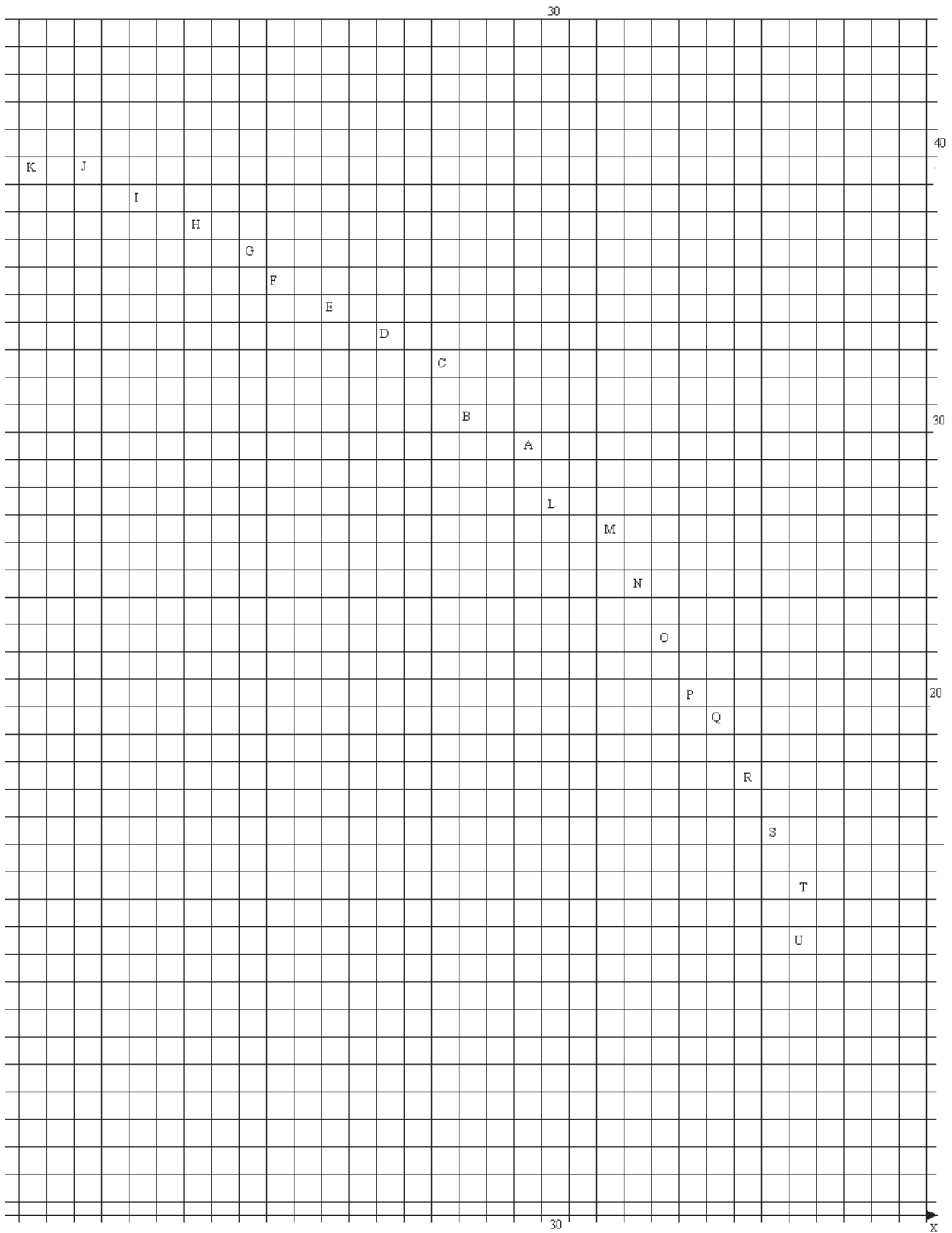

Fig. 20. The graphical representation of the database generated by the second test of the sensing subsystem

The analyzed coordinates and their Favorable Evidence Degree are shown in the table 2.

| Coordinate | μ |
|------------|-------|
| A (29,29) | 0.375 |
| B (27,30) | 0.35 |
| C (26,32) | 0.325 |
| D (24,33) | 0.3 |
| E (22,34) | 0.275 |
| F (20,35) | 0.25 |
| G (19,36) | 0.225 |
| H (17,37) | 0.2 |
| I (15,38) | 0.175 |
| J (13,39) | 0.15 |
| K (11,39) | 0.125 |
| L (30,27) | 0.35 |
| M (32,26) | 0.325 |
| N (33,24) | 0.3 |
| O (34,22) | 0.275 |
| P (35,20) | 0.25 |
| Q (36,19) | 0.225 |
| R (37,17) | 0.2 |
| S (38,15) | 0.175 |
| T (39,13) | 0.15 |
| U (39,11) | 0.125 |

Table 2. Results of the second test.

6.2.3 Third test

The configuration parameters and the sensing subsystem data have been the same ones of the second test; then the analyzed coordinates have been the same as the second test. The third test has been done just after the second, therefore, their Favorable Evidence Degree have been different from the one in the second test because μ_3 has been the Favorable Evidence Degree generated by the second test.

The analyzed coordinates and their Favorable Evidence Degree are shown in the table 3.

If it is considered the sequence of positions from K to U as an arc in the three tests; it is perceived that the Favorable Evidence Degree (μ) decreases as the coordinate is farther from the center of the arc. It means that the system is working as desired.

6.3 Planning subsystem

The planning subsystem is responsible for generating the sequence of movements the robot must perform to achieve a set point. The sensing subsystem has the objective of informing the planning subsystem about the position of obstacles; and the mechanical subsystem is the robot itself, it means, the mobile mechanical platform which carries all devices away from the other subsystems. This platform must also perform the sequence of movements which are borne by the planning subsystem.

| Coordinate | μ |
|------------|-------|
| A (29,29) | 0.565 |
| B (27,30) | 0.525 |
| C (26,32) | 0.49 |
| D (24,33) | 0.45 |
| E (22,34) | 0.415 |
| F (20,35) | 0.375 |
| G (19,36) | 0.34 |
| H (17,37) | 0.3 |
| I (15,38) | 0.265 |
| J (13,39) | 0.225 |
| K (11,39) | 0.19 |
| L (30,27) | 0.525 |
| M (32,26) | 0.49 |
| N (33,24) | 0.45 |
| O (34,22) | 0.415 |
| P (35,20) | 0.375 |
| Q (36,19) | 0.34 |
| R (37,17) | 0.3 |
| S (38,15) | 0.265 |
| T (39,13) | 0.225 |
| U (39,11) | 0.19 |

Table 3. Results of the third test.

6.4 Mechanical subsystem

The Emmy III mechanical part must perform the schedule which is determined by the planning system. The mechanical subsystem must know the position where it is, therefore, a monitoring position makes part of this construction. In the process, for each cell that the robot reaches, any possible error of position should be considered. Some Emmy III prototypes are described here.

6.4.1 First prototype of the autonomous mobile robot Emmy III

The first prototype is composed of a planning subsystem and a mechanical construction. The planning system considers all cells free.

The planning subsystem asks for the initial point and the aimed point. After that, a sequence of movements is given on a screen. Also a sequence of pulses is sent to the step Motors which are responsible for moving the physical platform of the robot. So, the robot moves from the initial point to the aimed point.

The Figure 21 shows the planning system screen.

The physical construction of the first prototype of the Emmy III robot is basically composed of a circular platform of approximately 286 mm of diameter and two-step motors. The Figure 22 shows the Emmy III first prototype. The planning subsystem is recorded in a notebook. And the communication between the notebook and the physical construction is made through the parallel port. A potency driver is responsible for getting the pulses from the notebook and sending them to the step motors which are responsible for moving the robot.

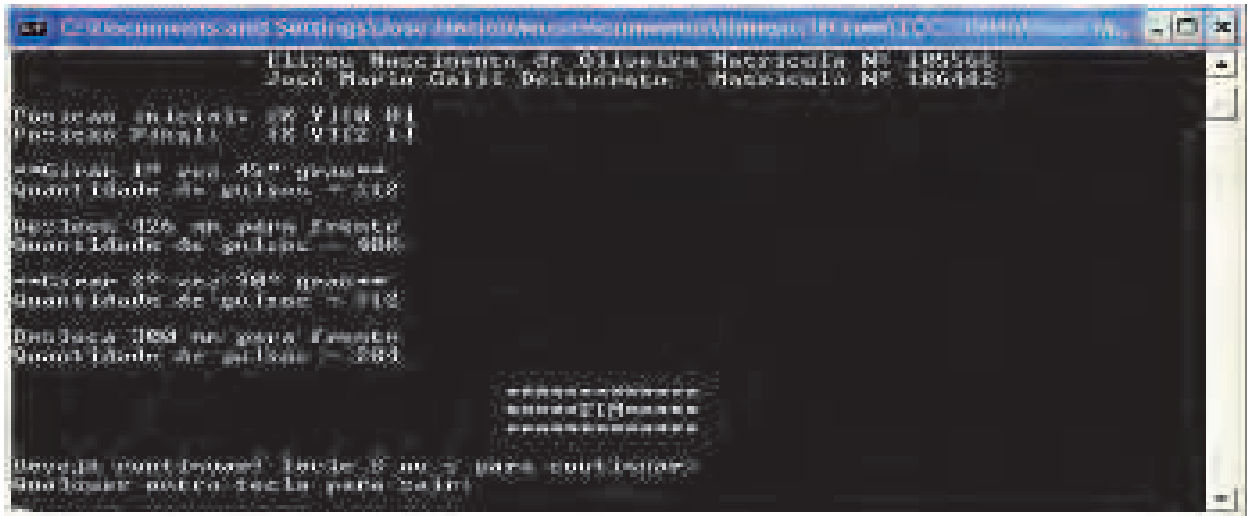

Fig. 21. Planning subsystem screen.



Fig. 22. The first prototype of the Emmy III robot.

6.4.2 Second prototype of the autonomous mobile robot Emmy III

Similarly to the first prototype, the second prototype of the autonomous mobile robot Emmy III is basically composed of a planning subsystem and a mechanical structure. The planning subsystem can be recorded in any personal computer and the communication between the personal computer and the mechanical construction is done through a USB port. The planning system considers the environment around the robot divided into cells. So, it is necessary to inform the planning system about the cell the robot is in, and the aimed cell too. The answer of the planning system is a sequence of cells which the robot must follow to go from the origin cell to the aimed cell.

The planning system considers all cells free. The Figure 23 shows the screen of the planning system.

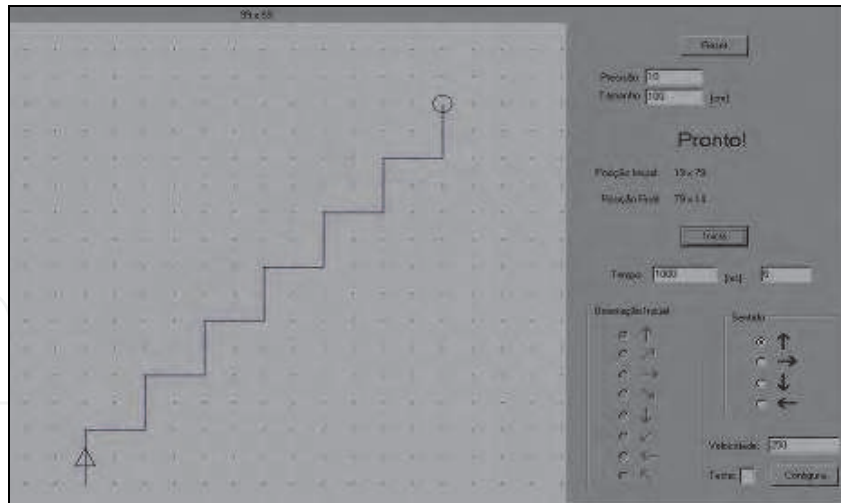

Fig. 23. The output of the planning system - Emmy III

Figure 24 shows the mechanical structure of Emmy III second prototype.



Fig. 24. The mechanical structure of the Emmy III second prototype

The planning system considers all cells free. The mechanical construction is basically composed of a steel structure, two DC motors and three wheels. Each motor has a wheel fixed in its axis and there is a free wheel. There is an electronic circuitry on the steel structure. The main device of the electronic circuitry is the microcontroller PIC18F4550 that is responsible for receiving the schedule from the planning system and activates the DC motors. Also there is a potency driver between the microcontroller and the DC motors.

7. Conclusions

In this work, it is discussed several autonomous mobile robots dubbed Emmy. They are based on a new kind of logic, namely the Paraconsistent Annotated Evidential Logic $\mathcal{E}\tau$. A logical controller - Paracontrol served as basis for control system and in the 3rd prototype it was incorporated the use of Artificial Neural Network, also based on Logic $\mathcal{E}\tau$.

This work presents a proposal of an autonomous mobile robot composed of three modules: sensing subsystem, planning subsystem and mechanical subsystem. The mechanical subsystem has not been implemented yet.

The aim of the sensing subsystem is to inform the planning subsystem the positions in which may have obstacles in. It considers the environment divided into coordinates.

The sensing subsystem is based on the Paraconsistent Artificial Neural Network - PANN. The sensing subsystem neural network is composed of two types of cells: Analytic Paraconsistent Artificial Neural Cell - CNAPa and Passage Paraconsistent Artificial Neural Cell - CNAPpa.

The output of the sensing subsystem is the Favorable Evidence Degree related to the sentence: there is obstacle in the position. In fact, the sensing subsystem generates a database with the Favorable Evidence Degree for each analyzed coordinate.

Some tests were made with the sensing subsystem. The reached results were satisfactory.

The next step is the implementation of the mechanical subsystem and the connection of the three subsystems.

8. References

- [1] Torres, Cláudio Rodrigo; Abe, Jair Minoro; Lambert-Torres, Germano; Da Silva Filho, João Inácio & Martins, Helga Gonzaga., J. I. da Silva Filho, H. G. Martins . A sensing system for an autonomous mobile robot based on the paraconsistent artificial neural network. *Lecture Notes in Computer Science*. Berlin/Heidelberg: Springer-Verlag, 2010, v. 6278, p. 154-163.
- [2] Torres, Cláudio Rodrigo "Sistema inteligente baseado na lógica paraconsistente anotada Et para controle e navegação de robôs móveis autônomos em um ambiente não estruturado", in Portuguese, Ph. D. Thesis, Federal University of Itajubá, Itajubá, MG, Brazil, 2010.
- [3] Torres, Cláudio Rodrigo; ABE, J. M. ; Torres, Germano Lambert ; Silva Filho, João Inácio da ; Martins, Helga Gonzaga . Autonomous Mobile Robot Emmy III. In: Nakamatsu, K.; Phillips-Wren, G.; Jain, L.C.; Howlett, R.J.. (Org.). *New Advances in Intelligent Decision Technologies*. 1 ed. Helderberg: Springer-Verlag, 2009, v. 199, p. 317-327.
- [4] Abe, Jair Minoro; Lambert-Torres, Germano; Da Silva Filho, João Inácio; Torres, Cláudio Rodrigo; Martins, Helga Gonzaga. Paraconsistent Autonomous Mobile Robot Emmy III, 6th Congress of Logic Applied to Technology - LAPTEC'2007. Santos, Proceedings of the VI Congress of Logic Applied to Technology. São Paulo - Brazil, 2007.
- [5] Abe, Jair Minoro ; Torres, Cláudio Rodrigo ; Lambert-Torres, Germano ; Nakamatsu, K. ; Kondo, M . Intelligent Paraconsistent Logic Controller and Autonomous Mobile Robot Emmy II. *Lecture Notes in Computer Science*, v. 4252, p. 851-857, 2006.
- [6] Abe, Jair Minoro; Torres, Cláudio Rodrigo ; Lambert-Torres, Germano ; Nakamatsu, K. ; Kondo, M . Intelligent Paraconsistent Logic Controller and Autonomous Mobile Robot Emmy II. In: 10th International Conference on Knowledge-Based, Intelligent Information & Engineering Systems, KES2006, 2006, Bournemouth. Proceedings of the 10th International Conference on Knowledge-Based, Intelligent Information & Engineering Systems. Bournemouth - UK : KES Pub., 2006.
- [7] Torres, Cláudio Rodrigo ; Lambert-Torres, Germano ; Silva, Luiz Eduardo Borges da ; Abe, Jair Minoro . Intelligent System of Paraconsistent Logic to Control Autonomous Moving Robots. In: 32nd Annual Conference of the IEEE Industrial Electronics Society, IECON'06, 2006, Paris. Proceedings of the 32nd Annual Conference of the IEEE Industrial Electronics Society. Paris : IEEE Press, 2006.

- [8] Da Silva Filho, João Inácio & Abe, Jair Minoro. Emmy: A Paraconsistent Autonomous Mobile Robot. In: Laptec' 2001 The 2 Congress of Logic Applied to Technology, 2001, São Paulo -Brazil. Logic, Artificial Intelligence and Robotics. Amsterdam : IOS - Press - Holanda, 2001. v. 1. p. 53-61.
- [9] Da Silva Filho, João Inácio, "Métodos de Aplicações da Lógica Paraconsistente Anotada de Anotação com Dois Valores LPA2v com Construção de Algoritmo e Implementação de Circuitos Eletrônicos", in Portuguese, Ph. D. Thesis, University of São Paulo, São Paulo, 1999.
- [10] Abe, Jair Minoro Some Aspects of Paraconsistent Systems and Applications. *Logique et Analyse*, v. 157, p. 83-96, 1997.
- [11] Abe, Jair Minoro. A logical system for reasoning with inconsistency. In: 5a Reunião Anual da SBPN'97, 1997, Aguas de Lindoia. Anais da 5a Reunião Anual da SBPN'97Ciência e Cultura na Globalização - Novos Paradigmas. Aguas de Lindoia : SBPN, 1997. p. 196-201.
- [12] Abe, Jair Minoro, "Fundamentos da lógica anotada" (Foundations of Annotated Logics), in Portuguese, Ph. D. Thesis, University of São Paulo, São Paulo, 1992.
- [13] Da Silva Filho, João Inácio; Lambert-Torres, Germano & Abe, Jair Minoro. Uncertainty Treatment Using Paraconsistent Logic - Introducing Paraconsistent Artificial Neural Networks. 211. ed. Amsterdam: IOS Press, 2010. 328 pp. p.
- [14] Da Silva Filho, João Inácio; Abe, Jair Minoro & Lambert-Torres, Germano. "Inteligência artificial com redes de análises paraconsistentes: teoria e aplicação", in Portuguese. Rio de Janeiro: LTC, 2008.
- [15] Elfes, A. Using occupancy grids for mobile robot perception and navigation, *Comp. Mag.*, vol. 22, No. 6, pp. 46-57, June 1989.
- [16] Borenstein, J. & Koren, Y. The vector field histogram: fast obstacle avoidance for mobile robots. *IEEE Journal of Robotics and Automation*. v. 7, p. 278-288, jun. de 1991.
- [17] Abe, Jair Minoro & Da Silva Filho, João Inácio. Manipulating Conflicts and Uncertainties in Robotics, *Multiple-Valued Logic and Soft Computing*, V.9, ISSN 1542-3980, 147-169, 2003.
- [18] Da Silva Filho, João Inácio & Abe, Jair Minoro. Para-Control: An Analyser Circuit Based On Algorithm For Treatment of Inconsistencies, Proc. of the World Multiconference on Systemics, Cybernetics and Informatics, ISAS, SCI 2001, Vol. XVI, Cybernetics and Informatics: Concepts and Applications (Part I), ISBN 9800775560, 199-203, Orlando, Florida, USA, 2001.
- [19] Da Silva Filho, João Inácio & Abe, Jair Minoro., Paraconsistent analyzer module, *International Journal of Computing Anticipatory Systems*, vol. 9, ISSN 1373-5411, ISBN 2-9600262-1-7, 346-352, 2001.
- [20] Desiderato, J. M. G. & De Oliveira, E. N., Primeiro Protótipo do Robô Móvel Autônomo Emmy III, in Portuguese, Trabalho de Conclusão de Curso, Universidade Metodista de São Paulo, São Bernardo do Campo - SP, Brazil, 2006.
- [21] Maran, L. H. C., Riba, P. A., Collett, R. G. & De Souza, R. R., Mapeamento de um Ambiente Não-Estruturado para Orientação de um Robô Móvel Autônomo Utilizando Redes Neurais Paraconsistente, in Portuguese, Trabalho de Conclusão de Curso, Universidade Metodista de São Paulo, São Bernardo do Campo - SP, Brazil, 2006.

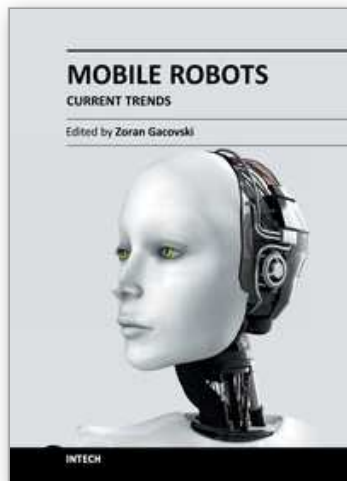

Mobile Robots - Current Trends

Edited by Dr. Zoran Gacovski

ISBN 978-953-307-716-1

Hard cover, 402 pages

Publisher InTech

Published online 26, October, 2011

Published in print edition October, 2011

This book consists of 18 chapters divided in four sections: Robots for Educational Purposes, Health-Care and Medical Robots, Hardware - State of the Art, and Localization and Navigation. In the first section, there are four chapters covering autonomous mobile robot Emmy III, KCLBOT - mobile nonholonomic robot, and general overview of educational mobile robots. In the second section, the following themes are covered: walking support robots, control system for wheelchairs, leg-wheel mechanism as a mobile platform, micro mobile robot for abdominal use, and the influence of the robot size in the psychological treatment. In the third section, there are chapters about I2C bus system, vertical displacement service robots, quadruped robots - kinematics and dynamics model and Epi.q (hybrid) robots. Finally, in the last section, the following topics are covered: skid-steered vehicles, robotic exploration (new place recognition), omnidirectional mobile robots, ball-wheel mobile robots, and planetary wheeled mobile robots.

How to reference

In order to correctly reference this scholarly work, feel free to copy and paste the following:

Cláudio Rodrigo Torres, Jair Minoro Abe, Germano Lambert-Torres and João Inácio da Silva Filho (2011). Autonomous Mobile Robot Emmy III, Mobile Robots - Current Trends, Dr. Zoran Gacovski (Ed.), ISBN: 978-953-307-716-1, InTech, Available from: <http://www.intechopen.com/books/mobile-robots-current-trends/autonomous-mobile-robot-emmy-iii>

INTECH
open science | open minds

InTech Europe

University Campus STeP Ri
Slavka Krautzeka 83/A
51000 Rijeka, Croatia
Phone: +385 (51) 770 447
Fax: +385 (51) 686 166
www.intechopen.com

InTech China

Unit 405, Office Block, Hotel Equatorial Shanghai
No.65, Yan An Road (West), Shanghai, 200040, China
中国上海市延安西路65号上海国际贵都大饭店办公楼405单元
Phone: +86-21-62489820
Fax: +86-21-62489821

© 2011 The Author(s). Licensee IntechOpen. This is an open access article distributed under the terms of the [Creative Commons Attribution 3.0 License](#), which permits unrestricted use, distribution, and reproduction in any medium, provided the original work is properly cited.

IntechOpen

IntechOpen