

We are IntechOpen, the world's leading publisher of Open Access books Built by scientists, for scientists

4,800

Open access books available

122,000

International authors and editors

135M

Downloads

Our authors are among the

154

Countries delivered to

TOP 1%

most cited scientists

12.2%

Contributors from top 500 universities

**WEB OF SCIENCE™**Selection of our books indexed in the Book Citation Index
in Web of Science™ Core Collection (BKCI)

Interested in publishing with us? Contact book.department@intechopen.com

Numbers displayed above are based on latest data collected.

For more information visit www.intechopen.com

Application of Silicon Carbide in Abrasive Water Jet Machining

Ahsan Ali Khan and Mohammad Yeakub Ali
*International Islamic University Malaysia
Malaysia*

1. Introduction

Silicon carbide (SiC) is a compound consisting of silicon and carbon. It is also known as carborundum. SiC is used as an abrasive material after it was mass produced in 1893. The credit of mass production of SiC goes to Edward Goodrich Acheson. Now SiC is used not only as an abrasive, but it is also extensively used in making cutting tools, structural material, automotive parts, electrical systems, nuclear fuel parts, jewelries, etc.

AWJM is a well-established non-traditional machining technique used for cutting difficult-to-machine materials. Nowadays, this process is being widely used for machining of hard materials like ceramics, ceramic composites, fiber-reinforced composites and titanium alloys where conventional machining fails to machine economically. The fact is that in AWJM no heat is developed and it has important implications where heat-affected zones are to be avoided. AWJM can cut everything what traditional machining can cut, as well as what traditional machining cannot cut such as too hard material (e.g. carbides), too soft material (e.g. rubber) and brittle material (e.g. glass, ceramics, etc.). The basic cutting tool used in water jet machining is highly pressurized water that is passed through a very small orifice, producing a very powerful tool that can cut almost any material. Depending on the materials, thickness of cut can range up to 25 mm and higher (Kalpakjian & Schmid, 2010). A water jet system consists of three components which are the water preparation system, pressure generation system and the cutting head and motion system.

As far as technology development is concerned, three types of water jet machining have been found and used. The first type is a typical water jet machining which was used in the middle of 18th century. The first attempt was in Russia in 1930s to cut hard rock using the pressurized water jet. The typical water jet machining used only water as the cutting tool which allows only cutting limited materials. The second type is AWJM as the improvement to the original water jet machining technique. Addition of abrasive to water enhances the capability of machining by many times. AWJM is an appropriate and cost effective technique for a number of uses and materials. Third type of AWJM includes cutting of difficult-to-machine materials, milling and 3-D-shaping, turning, piercing, drilling, polishing etc. These operations can be performed just by using plain water jet machining. However, due to special considerations such like the type of material or shape complexity of the part to be produced, the addition of the abrasive material is required.

The use of the AWJM for machining or finishing purposes is based on the principle of erosion of the material upon which the jet is incident. The primary purpose of the abrasive material within the jet stream is to develop enough forces to erode the work material. However, the jet also accelerates the abrasive material to a high speed so that the kinetic energy of the abrasives is high enough to erode the work material. The secondary purpose of the water is to carry away both the abrasive material and the eroded material from the machining zone and clear the work area. AWJM gives a clean cut without any damage of the cut surface.

2. Application of AWJM

Generally, water jets are used for (Momber W. & Kovacevic, R., 1998)

1. industrial cleaning
2. surface preparation
3. paint, enamel and coating stripping
4. concrete hydrodemolition
5. rock fragmentation
6. solid stabilization
7. decontamination
8. demolition
9. metal recycling
10. manufacturing operations

In the area of manufacturing, the water jet-technique is used mainly for material cutting by plain water jets (e.g., plastics, thin metal sheets, textiles, foam, very hard materials like carbides, very soft materials like rubber, etc.). Sometimes burrs are formed due to machining of metals by conventional techniques. Those burrs can be removed by plain water jet machining. Some parts work under dynamic load and fatigue failure is the most common type of failure for those parts. Fatigue strength of those parts can be improved by peening the surface with a high pressure water jet. Fibrous materials like Kevlar cannot be machined by conventional machining techniques because of pullouts of the fibers. But AWJM can be employed to machine those materials without any pullout of fibers. AWJM can also be used for milling 3-D shapes. During abrasive water jet milling the surfaces not to be machined is masked before machining and only the areas to be machined are exposed to the jet head. Turning and grooving can also be performed on a lathe using an abrasive water jet. Piercing, drilling and trepanning are other cutting operations performed by AWJM. Water jet machining is a very common technique used to polish and improve work surface smoothness.

The performance of AWJM depends on some key factors. The hardness of the abrasive is an important factor. Harder the abrasive, faster and more efficient will be the machining process. Machining efficiency of abrasives also depends on their structure. Grain shape is another factor in evaluation of an abrasive material for abrasive water-jet process. Shape of abrasives is characterized by their relative proportions of length, width and thickness. During AWJM machining rate to a large extent depends on the size of the grains. Larger grains have higher kinetic energy and their cutting ability is also higher. But though the material removal rate of smaller grains is smaller, they are used for finishing works. Grain-size distribution and average grain size also play role in the performance of AWJM.

AWJM has many advantages over other machining techniques. They are:

1. Almost all types of materials can be machined by AWJM irrespective of their hardness, softness or brittleness. Almost all types of metals, plastics, fibrous materials, glass, ceramics, rubbers, etc. can be machined by this technique.
2. The surface machined by AWJM is smooth and usually they don't need any subsequent machining operation. Abrasives of very small size should be used to produce a smooth surface.
3. AWJM is performed at room temperature. For that reason there is no problem of heat affected zone like other machining techniques. There is no structural change, no phase transformation, no oxidation or no decarburization of the machined surface.
4. The technique is environment friendly. Abrasives like SiC, garnet, alumina, silica sand, olivine together with water are environmental friendly. They don't emit any toxic vapor or unpleasant odor.
5. A major problem in conventional machining like milling, drilling, etc. is burr forming. But AWJM doesn't produce any burr. Rather the technique is used for deburring.

3. Elements of AWJM

In AWJM abrasives are added to water. The performance of AWJM to a great extent depends on the properties of abrasives. The geometry of cut is a key indicator of AWJM.

3.1 Water abrasive water jet machine

The main element of the abrasive water jet system is the abrasive jet. Water is pressurized up to 400 MPa and expelled through a nozzle to form a high-velocity jet. In AWJM abrasives are added to water using a specially shaped abrasive-jet nozzle from separate feed ports. As the momentum of water is transferred to the abrasives, their velocities increase rapidly. It results a focused, high-velocity stream of abrasives that exits the nozzle and performs the cutting action of the work surface. A schematic diagram of AWJM is presented in Fig.1

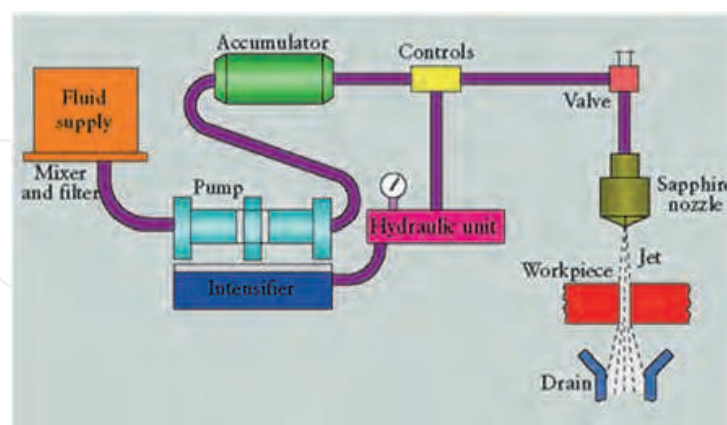

Fig. 1. Abrasive water jet machining (Source: Kalpakjian & Schmid, 2010)

Normal water is filtered and passed to the intensifier. The intensifier acts as an amplifier as it converts the energy from the low-pressure hydraulic fluid into ultra-high pressure water. The hydraulic system provides fluid power to a reciprocating piston in the intensifier center section to amplify the water pressure. Using a control switch and a valve water is pressurized to the nozzle. Abrasive is added to water in the nozzle head (Fig 2) and the

mixture comes out of the nozzle with a very high energy and pressure. In AWJM water is pressurized up to 55,000 pounds per square inch (psi) and then is forced to come out through a small orifice (round or square) at a speed of 2500 feet (762meters) per second, which is about two and half times the speed of sound. As water exits the nozzle at a high speed, the abrasive material is injected into the jet stream or sucked into the stream by a phenomenon known as the 'Venturi' effect. The main purpose of addition of abrasives is to enhance the jet length and improve the cutting ability of the jet. It was found by Chacko et al., 2003 that an addition of polymer to the water jet increases the jet penetration depth. There are two types of AWJM; the slurry and entrainment. The only thing that differentiates them is the way the abrasives are added to the water. In the slurry system, the abrasive is mixed with the water before the water being pressurized. The mix is then pressurized and passed to the end of the nozzle. This method causes extensive wear to the elements or parts of the water jet head due to the friction of the abrasives. In an entrainment system a pipe is connected to the water inlet. When the high-velocity pressurized water passes through the pipe, a vacuum is created causing the abrasive to be sucked into the water stream.

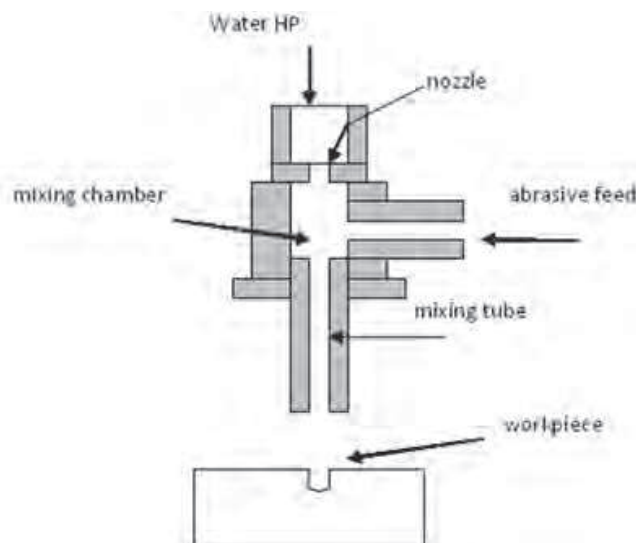

Fig. 2. Abrasive water jet cutting head.

3.2 Abrasives

SiC is known for its very high hardness and abrasion resistance. It is dark gray in color; its hardness and modulus of elasticity are 2,800 knoop (kg/mm²) and 476 GPa respectively. This material is produced according to specific technology to imitate the natural abrasive. It is heat resistant, and decomposes when heated to about 2,700°C. Very pure silicon carbide is white or colorless; crystals of it are used in semiconductors for high-temperature applications. Its small coefficient of expansion, which decreases with increasing temperature, high hardness and sharp crystal edges make it a very good abrasive. It is primarily used for grinding nonferrous materials such as brass, copper, bronze and aluminum. Other applications of SiC include grinding of glass, wood, rubber and plastics. Recently SiC is gaining popularity in as an excellent abrasive for AWJM.

But a survey shows that 90% of the AWJM is done using garnet (Mort, 1995). In industries 80 mesh garnet is a popular abrasive. It is possible to cut slightly faster rate with harder abrasives. However the harder abrasives also cause the mixing tube on the nozzle to wear

rapidly. It is worth mentioning that not all garnets are the same. There are wide variations in purity, hardness, sharpness, etc, that can also affect the cutting speed and operating cost. Garnet is a natural type of abrasive. Garnet has three basic structural components. They are Almandine ($\text{Fe}_3, \text{Al}_2(\text{SiO}_4)_3$), Pyrope ($\text{Mg}_3\text{Al}_2(\text{SiO}_4)_3$) and Spessartite ($\text{Mn}_3\text{Al}_2(\text{SiO}_4)_3$). Garnet also contains impurities like SiO_2 , Al_2O_3 , FeO , MnO , MgO , and CaO . The hardness of garnet abrasive particles of Almandine, Pyrope and Spessartite are 7-7.5 Mohs, 7.5 Mohs and 7-7.5 Mohs respectively. Aluminum Oxide (Al_2O_3) is another popular abrasive used in AWJM. It is also known as alumina. Its melting point is about $2,000^\circ\text{C}$ and specific gravity is about 4.0. It is insoluble in water and organic liquids and slightly soluble in strong acids and alkalis. Alumina is available in two crystalline forms. Alpha alumina is composed of colorless hexagonal crystals. Gamma alumina is composed of minute colorless cubic crystals with specific gravity about 3.6 that are transformed to the alpha form at high temperatures. Alumina powder is formed by crushing crystalline Alumina. It is white when pure. Alumina is extremely tough and is wedge shaped. It is used for high-speed penetration in tough materials without excessive shedding or fracturing of the grains. It is mainly used for grinding high tensile strength materials like carbon steels, alloy steels, tough bronze and hard woods. Other abrasives used in AWJM are olivine, slag, silica sand, etc.

3.3 Geometry of cut

The surface of cut is not vertical. It is characterized by a taper. Based on the width of cut at the top and the bottom it is calculated as follows:

$$T_R = (b - a) / 2$$

For a divergent (V-shaped) slot b is larger than a as shown in Fig. 3.

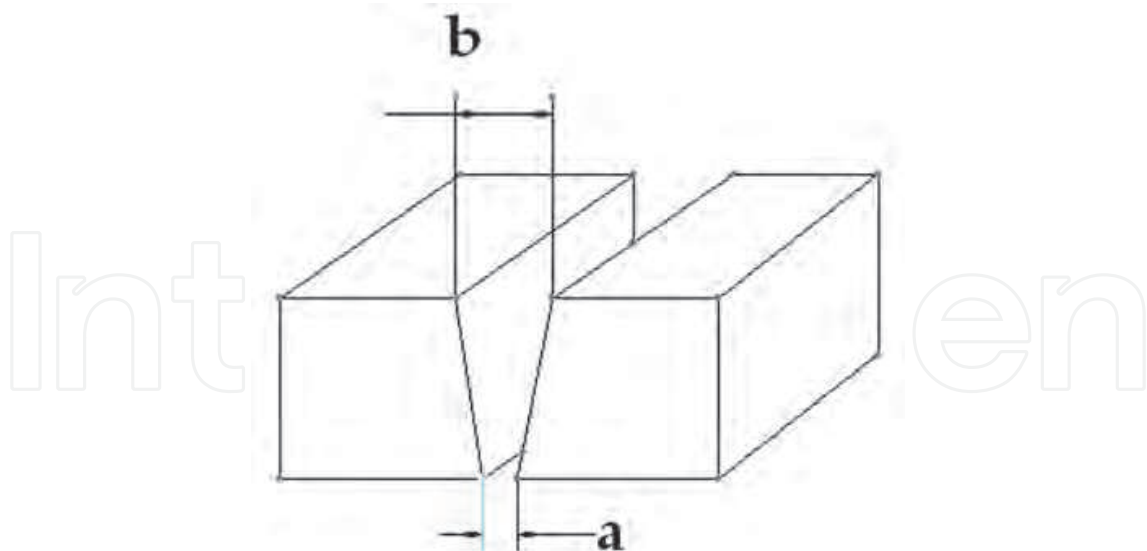

Fig. 3. Usual geometry cut

Hochheng & Chang, 1994 and Momber et al., 1996 investigated the top width of cut during AWJM of ceramics using magnesia and bauxite abrasives and found that the top width of cut decreases with the work feed. But the top width of cut increases with increase in pressure and SOD. However, the slot may be of different shapes as shown in Fig. 4.

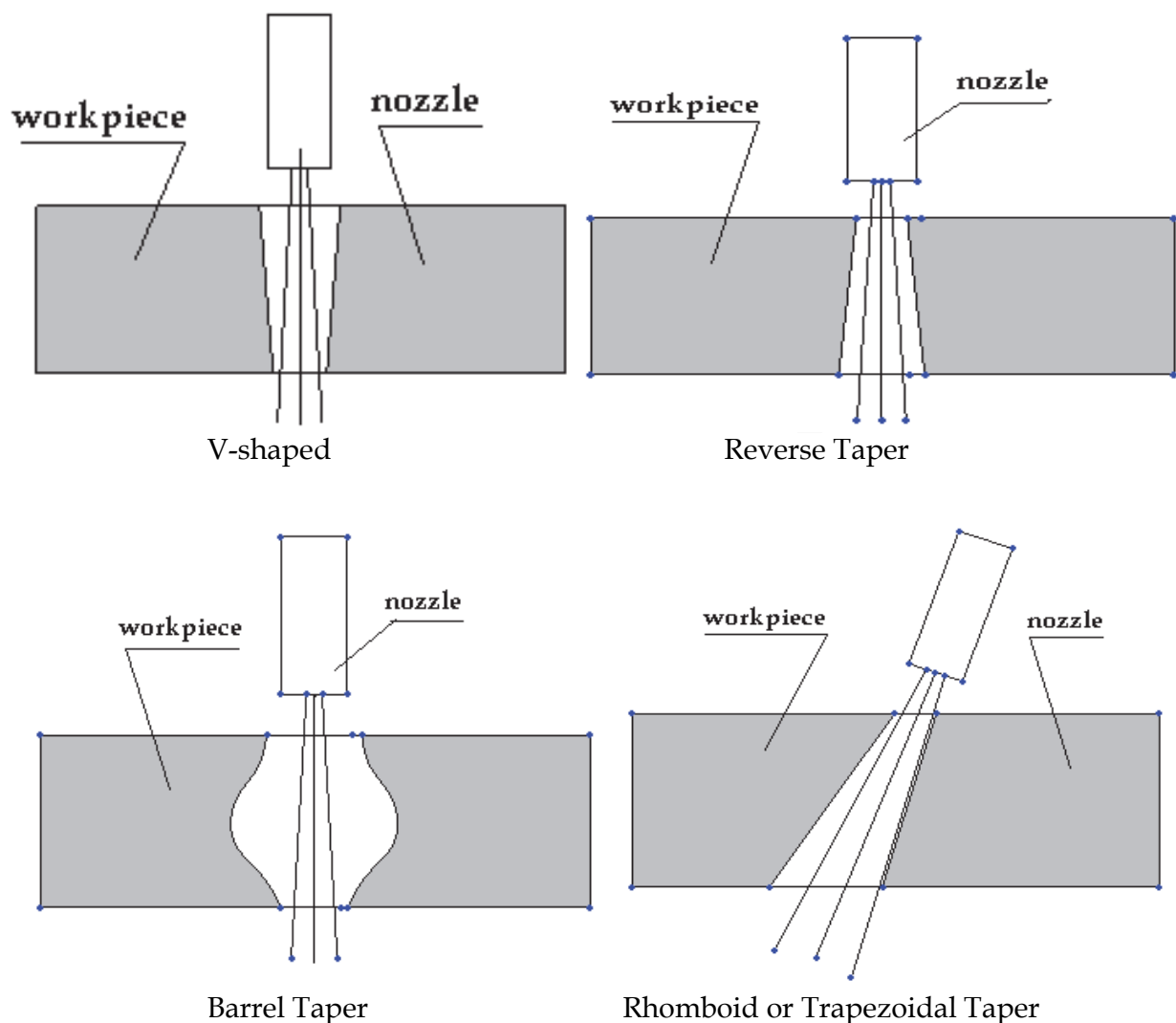

Fig. 4. Different shapes of the taper produced

V shaped taper is produced a result of the jet spending more time over an area to erode the top of the material more than the bottom. Also, "splash back" as the abrasives are bounced back from the material will tend to erode the sides. This is the most common type of taper. Reverse taper tends to happen during AWJM of soft materials where the material is rapidly eroded or when work feed rate is very slowly. Because as the jet stream expands farther away from the nozzle, it removes more material from the bottom than from the top. Barrel taper is produced where the middle is wider than the top or the bottom. Barrel taper is usually produced during machining of very thick materials. Rhomboid taper is actually normal V-shaped taper that has been tilted. It is produced when the nozzle is not perpendicular to the work surface.

Along the vertical surface the quality of the surface is not uniform. It can be divided into three zones (Fig. 5). At the top there is a small initial damaged zone height h_{IDZ} . After that zone there is a smoother zone of height h_{SC} . At the bottom of the surface there is a wavy surface of height h_{RC} .

A typical waviness of the cut slot is shown in Fig. 6. Because the cutting tool is basically a "floppy tool". The jet lags between where it first enters the material and where it exits. Bottom of the jet lags behind the cutting head.

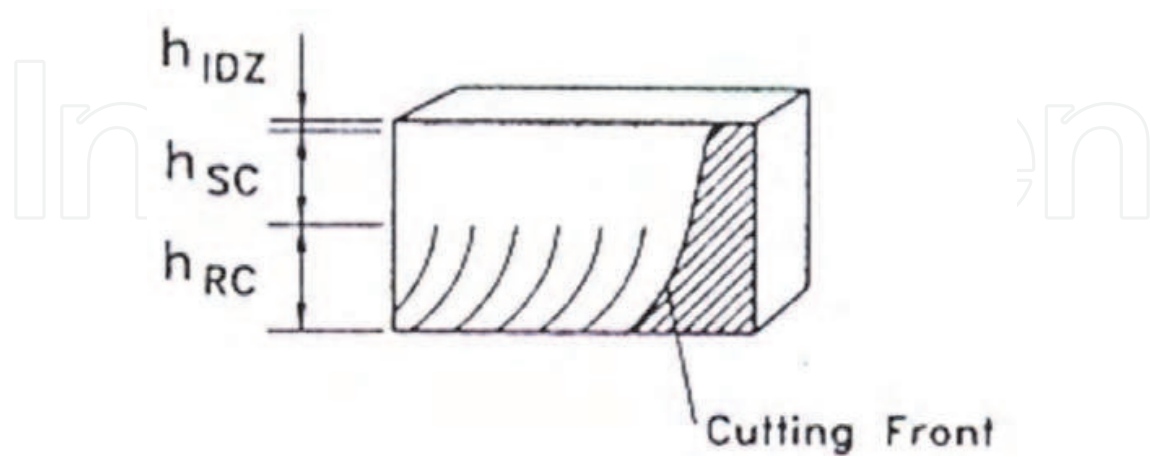

Fig. 5. Surface cut by AWJM (Source: Momber & Kovacevic, 1998)



Fig. 6. Waviness of the cut surface (Source: Waterjet machining tolerances, 2011, <http://waterjets.org>)

4. Machining of carbides by SiC

4.1 Influence of jet pressure on work surface roughness

Experiments were conducted to investigate the influence of pressure on surface roughness. During the experiments the jet pressure were varied from 35 kbar to 50 kbar. Work feed rate, abrasive flow rate and depth of cut were kept constant at 1.36 mm/min, 135 g/min and 3.18 mm respectively. The results show that increasing in pressure will decrease the roughness of work materials. In short surface finish becomes smoother and better. It is presented in Fig. 7. From Fig. 8 is evident that surface roughness drastically increases at a higher depth from the top surface. Fig. 9 shows the deterioration of surface smoothness along the depth of the cut surface.

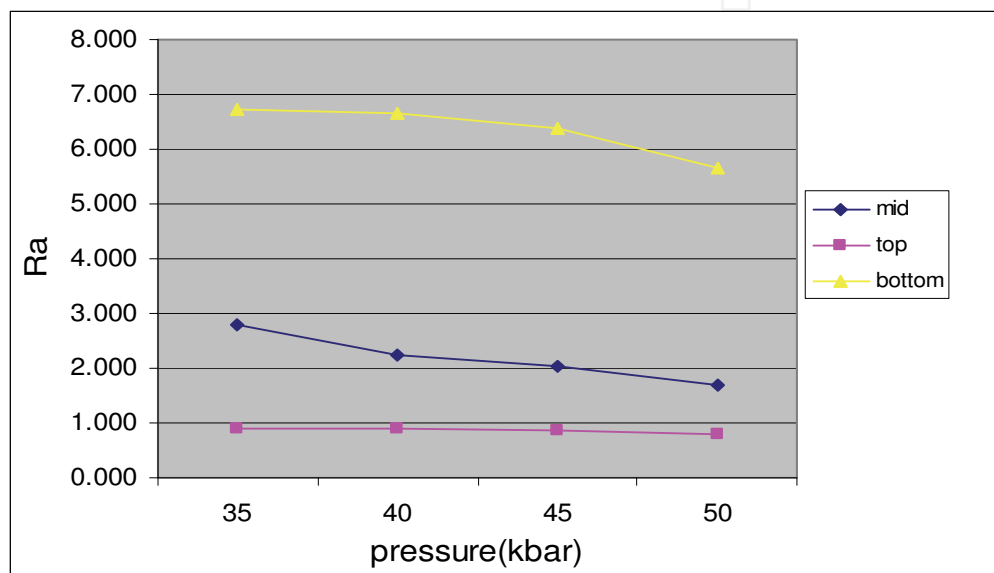

Fig. 7. Effect of pressure on surface roughness

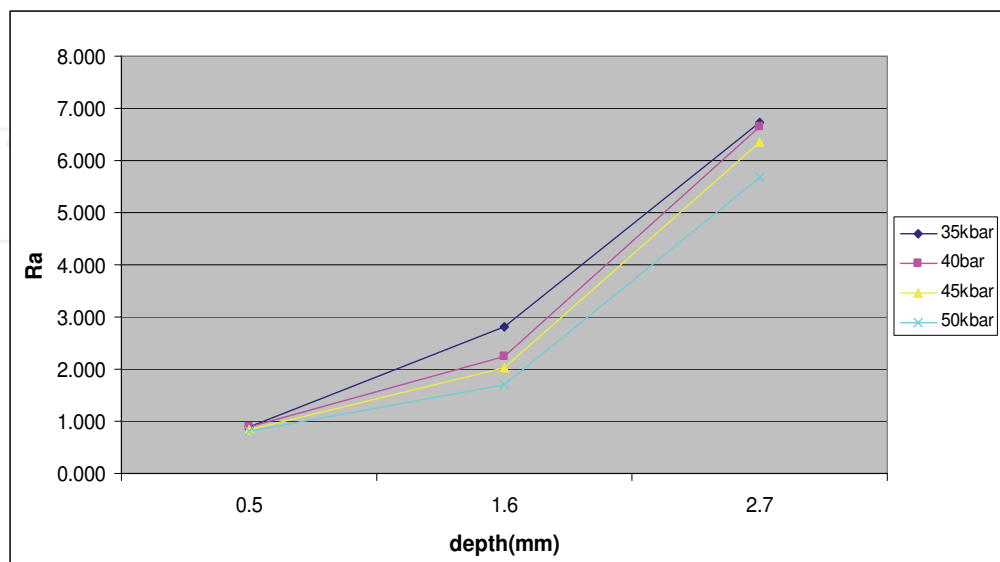
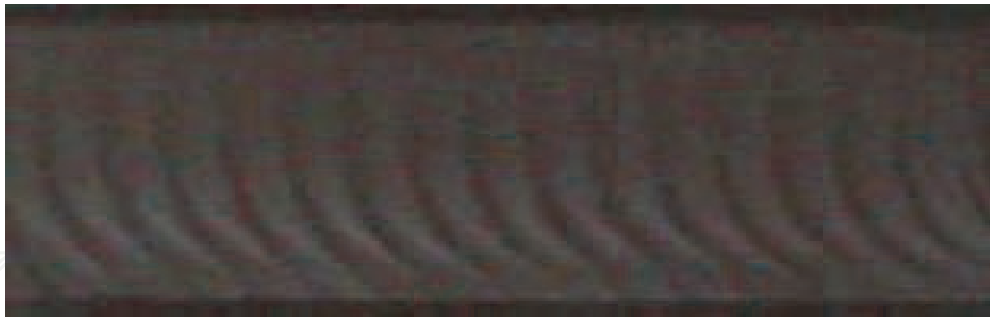
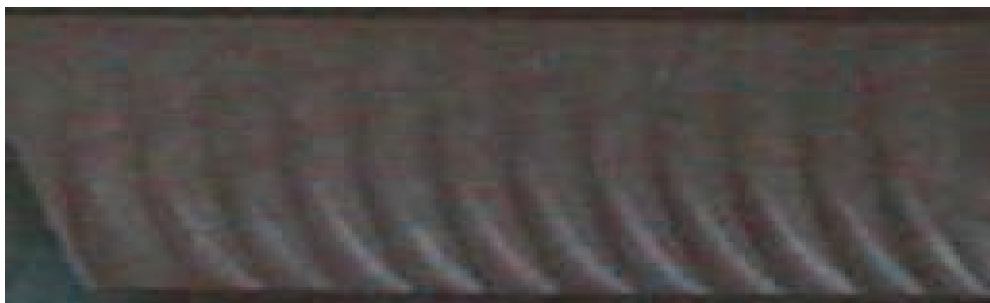

Fig. 8. Surface roughness at different depths from the top surface of carbide



Pressure: 35kbar



Pressure: 40kbar

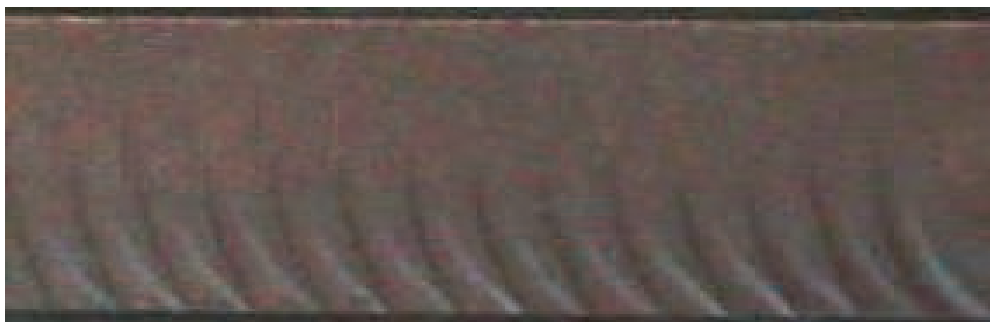

Pressure: 45kbar



Pressure: 50kbar

Fig. 9. Surfaces of the machined insert carbide tools at constant flow rate (135g/min)

4.2 Influence of abrasive flow rate on surface roughness

This section presents the results of the experiments conducted to investigate the influence of abrasive flow rate on surface finish. In these experiments abrasive flow rate was varied from 135 g/min to 175 g/min. Work feed rate and jet pressure were kept constant at 1.36 mm/min and 45 kbar respectively. It can be observed from Fig. 10 that abrasive flow rate play a vital role in water jet cutting. Surface roughness values are presented at the top, middle and at the bottom of the cut surface. The surface roughness decreases due to larger amount per minute of abrasives used. Means the surface of the cutting profile becomes smoother with higher flow rate. In Fig. 11 surface roughness at different depths from the top surface of carbide is presented. Increasing the flow rate will reduce surface roughness. Surfaces cut at different abrasive flow rate are presented in Fig. 12.

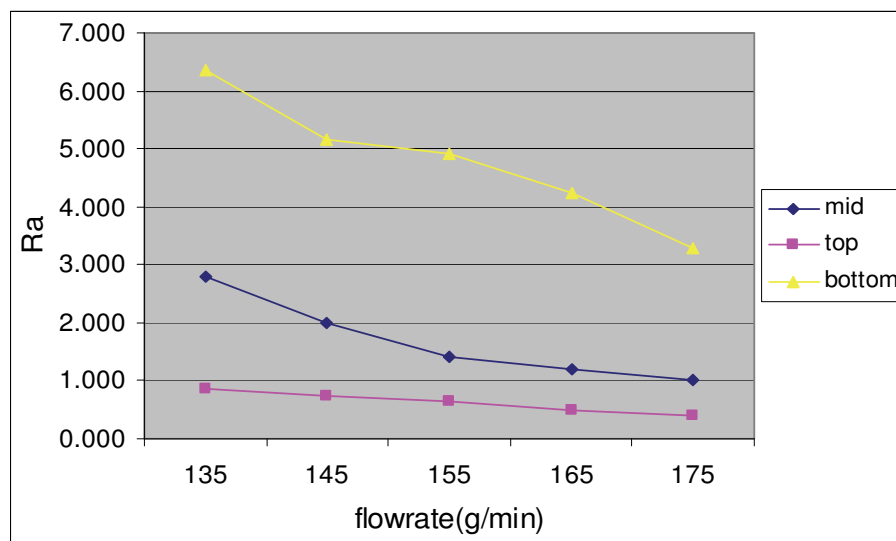

Fig. 10. Effect of abrasive mass flow rate on surface roughness during machining carbide.

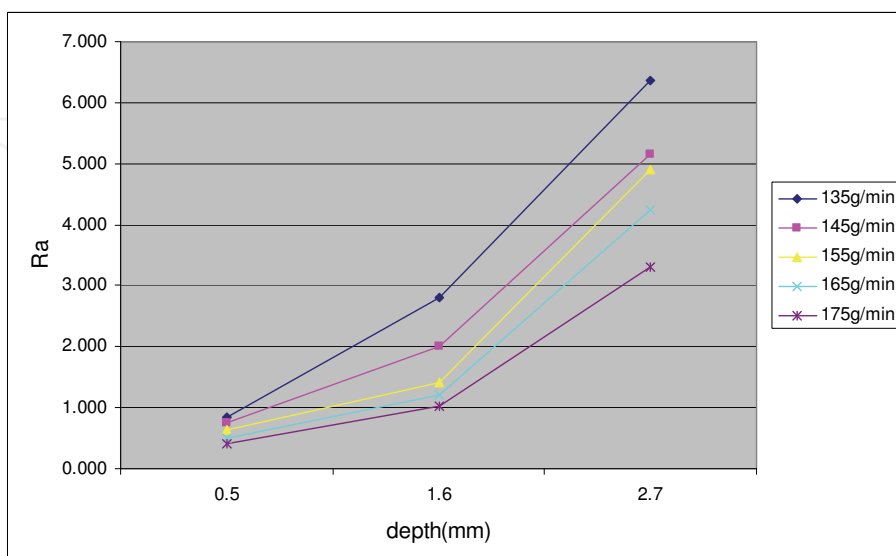
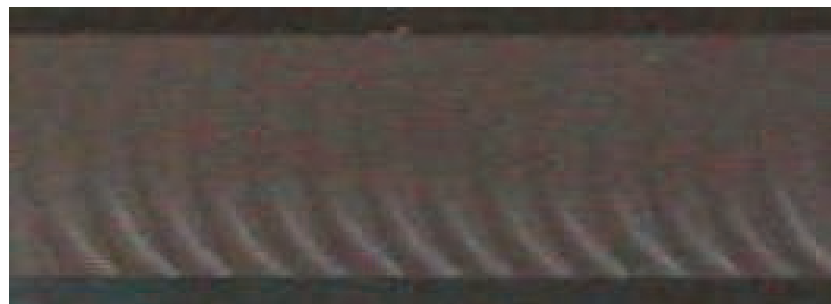
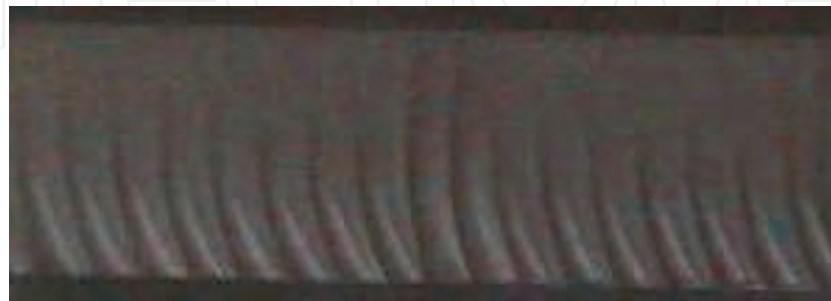

Fig. 11. Surface roughness at different depths from the top surface of carbide



Abrasive mass flow rate: 135 g/min



Abrasive mass flow rate: 145 g/min



Abrasive mass flow rate: 155 g/min

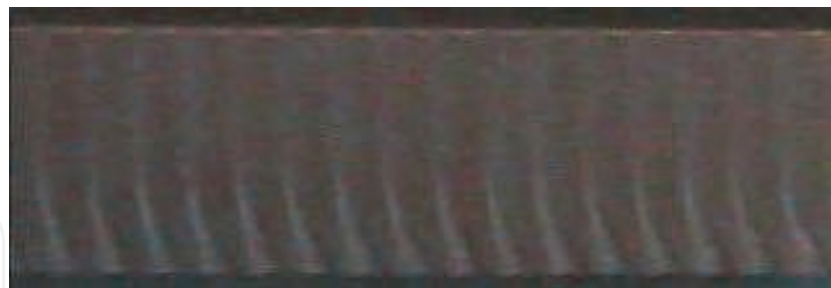

Abrasive mass flow rate: 165 g/min



Abrasive mass flow rate: 175 g/min

Fig. 12. Photographs of the machined carbides by varying the flow rate

5. Contamination

In AWJM material removal occurs through erosion and results from the interaction between an abrasive water jet and the work-piece materials. However, there are certain drawbacks in this technology. One of them is the contamination of the surfaces generated during the machining process by fractured abrasives. This contamination may generate serious problems with the further treatment of these surfaces, such as grinding, welding and/or coating. Other surface properties such as fatigue resistance will also influence negatively by surface contaminants.

Although particle embedment is a shortcoming of this technology, it can be minimized by controlling the machining parameters. However, it was reported that if the nozzle is oscillated during AWJM, then contamination reduces to a great extent (Chen et al., 2002 and Siores et al., 2006). The present study presents the influence of machining parameters on surface contamination of mild steel. Some investigations performed for the blasting of steel surfaces by air-driven solid particles found that the higher the blasting angle, the higher the contamination. Other than that, there is also a study to reduce the contamination by using the oscillation nozzle. The major aim of the present study is to investigate abrasive contamination on the surface of the mild steel during the AWJM. Furthermore, the parameters of the AWJM which are the feed rate, flow rate of the abrasive and the pressure were varied during the AWJ cutting process in order to study their level of contaminations with the changes of parameters. Then a quantitative microstructure analysis using Digital Camera Microscope was performed to investigate abrasive contamination at the cutting surfaces. In this microscope the number of embedded SiC abrasives can be counted when the image of the surface is captured. To investigate the contamination of the surfaces by abrasives, 16 experiments were conducted with variables shown in the Table 1.

No.	Pressure (kpsi)	Flowrate (g/s)	Feedrate (mm/min)
1	25	5	10
2	25	10	20
3	25	15	30
4	25	20	40
5	30	5	20
6	30	10	10
7	30	15	40
8	30	20	30
9	35	5	30
10	35	10	40
11	35	15	10
12	35	20	20
13	40	5	40
14	40	10	30
15	40	15	20
16	40	20	10

Table 1. Experimental variables

For the analysis of the abrasive contamination, three zones with different depths namely Zone A, Zone B and Zone C have been analyzed. The zones of measuring abrasive contamination are shown in Fig. 13.

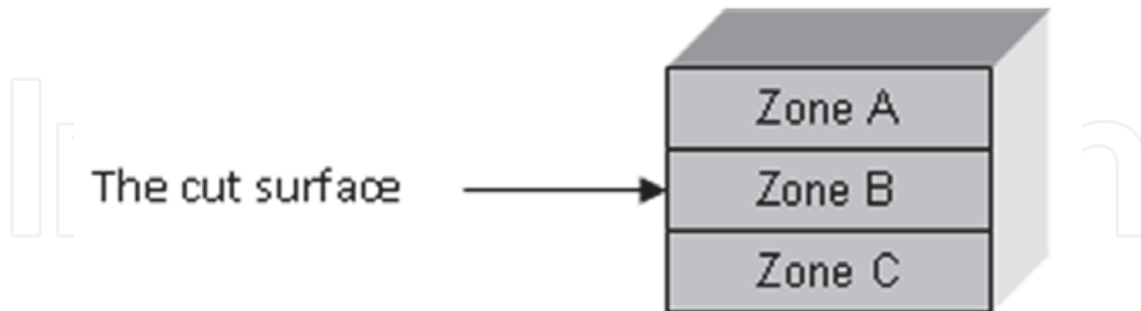
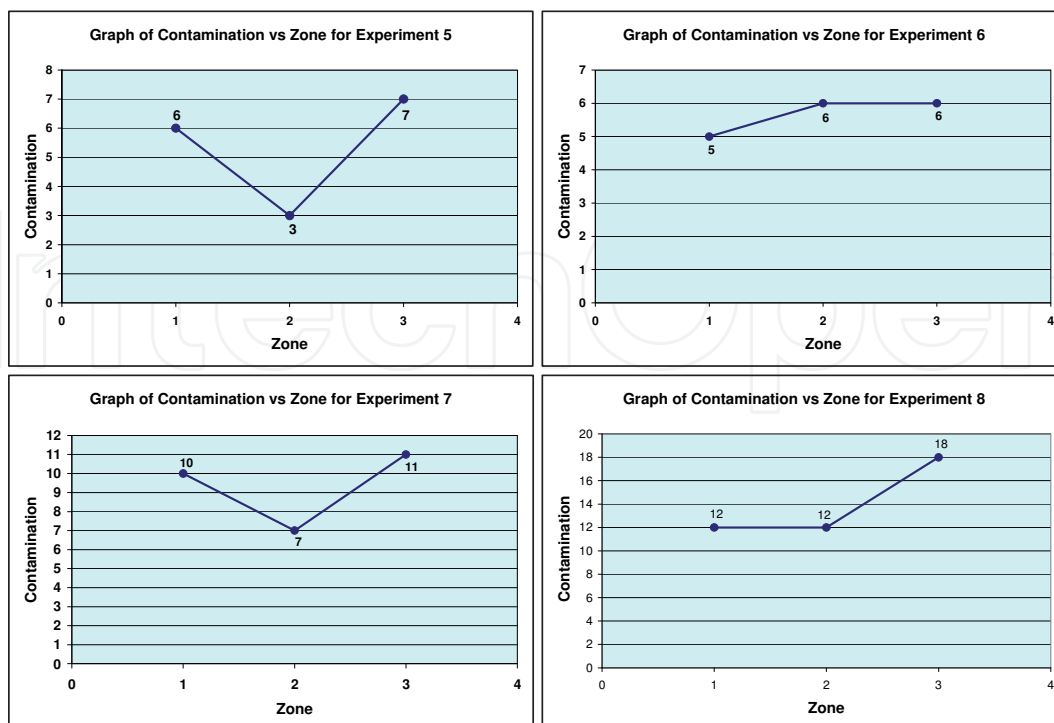

Fig. 13. Measured zone of contamination

The relationship of the abrasive flow rate with abrasive contaminations at zones A, B and C are presented in Fig.14. In this figure zone 1, zone 2 and zone 3 stand for zones A, B and C respectively. In Fig. 14 Contamination has been presented for four different levels of pressures: 25 kpsi, 30 kpsi, 35kpsi and 40 kpsi with the changes of flow rate and feed rate. From these graphs it can be observed that the pattern of the graph is basically same for these sixteen samples. Most of the graphs show that the minimum amount of abrasive contamination is at Zone B. It is also observed that in most of the cases the maximum contamination is at zone C. As the abrasives move down they lose their kinetic energy and due to friction with the work surface they are embedded to it. This is also supported by the work of (Keyurkumar, 2004).

Embedding of abrasives on the cut surface for a few experiments are shown Table 2.



(a) Pressure 25 kpsi

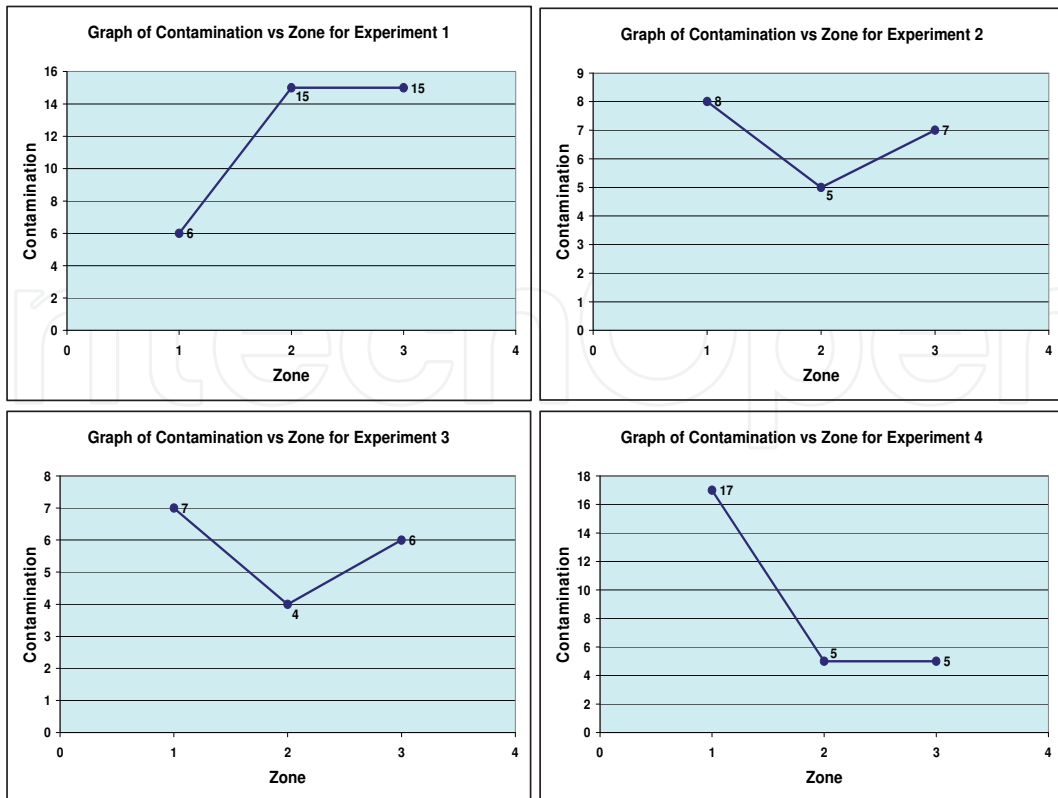

(b) Pressure 30 psi

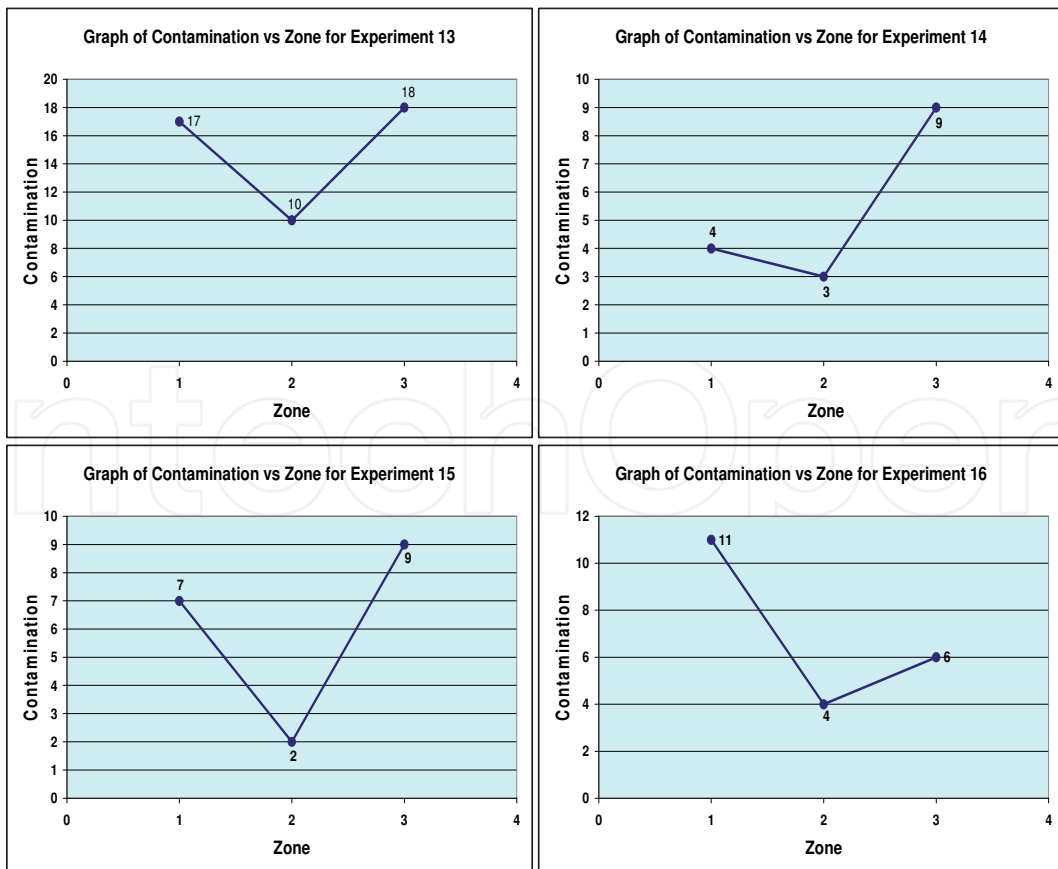

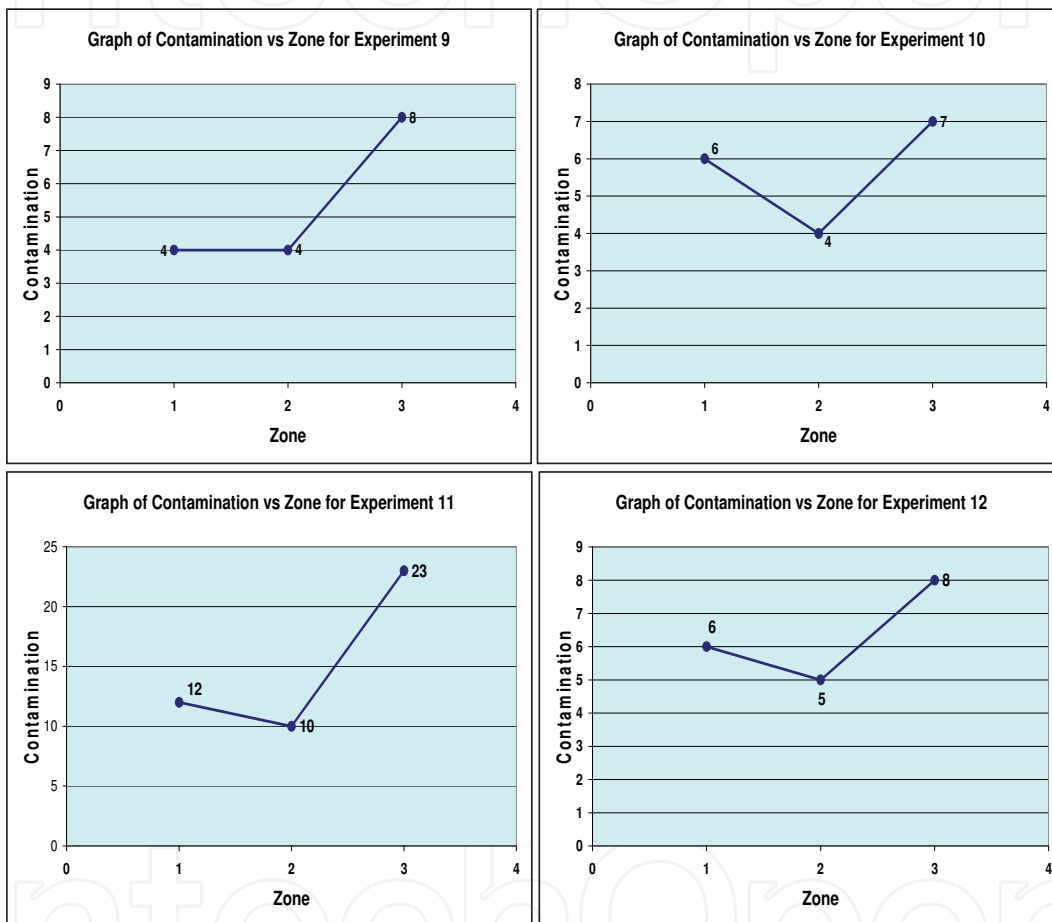

(c) Pressure 35 kpsi

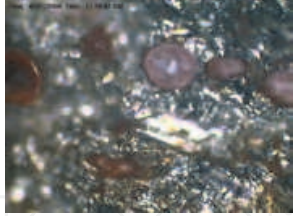

(d) Pressure 40 psi

Fig. 14. Contamination at different zones and at different pressures.

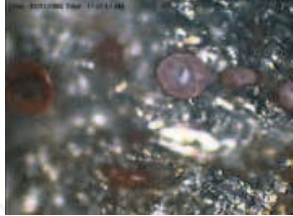
Experiment 5	Zone A	Zone B	Zone C
Pressure : 30 kpsi Flow rate : 5 g/s Feed rate : 20mm/min			
Contaminations	6	3	7

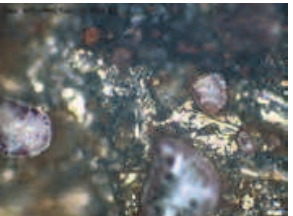
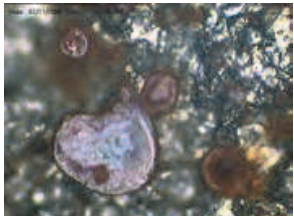
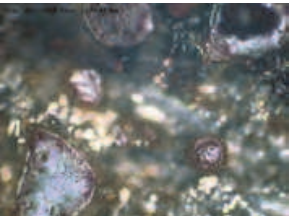
Experiment 6	Zone A	Zone B	Zone C
Pressure : 30 kpsi Flow rate : 10 g/s Feed rate : 10 mm/min			
Contamination	5	6	6

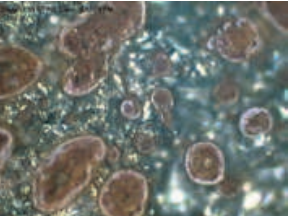
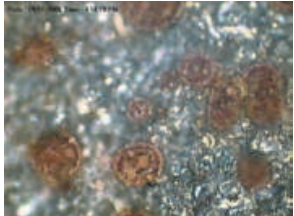
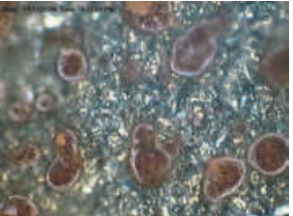
Experiment 13	Zone A	Zone B	Zone C
Pressure : 40 kpsi Flow rate : 5 g/s Feed rate : 40 mm/min			
Contamination	17	10	18



Experiment 16	Zone A	Zone B	Zone C
Pressure : 40 kpsi Flow rate : 20 g/s Feed rate : 10 mm/min			
Contamination	11	4	6

Table 2. Embedding of the abrasives

5.1 Comparison of SiC with other abrasives in AWJM

In order to compare the capability of SiC with other abrasives, glass was taken as the work material. The main properties of glass are: hardness- 600 knoops, density- 2200 kg/m³, tensile strength- 70 MN/m² and specific heat capacity- 750 J/kg °C. Three types of abrasives used in the present study were garnet, Al₂O₃ and SiC. Their hardness is 1350 knoops, 2100 knoops and 2500 knoops respectively. Experiments were conducted on a water jet machine WJ 4080. The machine was equipped with a controller type 2100 CNC Control. The nozzle used for the abrasive water jet was made of carbide with the orifice diameter of 0.1 mm. The jet was perpendicular to the work surface. The abrasive water jet in cutting process is shown in Fig. 15. After the cutting process the top width and the bottom width of the slot was measured using an optical microscope Mitutiyo Hismet II.

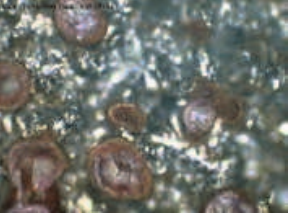
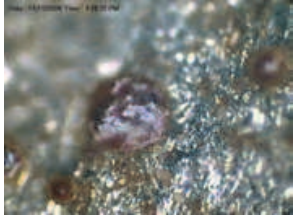

Fig. 15. Experimental set-up

5.2 Effect of different cutting parameters on taper of cut

Taper of cut was calculated according to the mathematical expression; $T_R = (b - a)/2$, where T_R , b and a are taper of cut, top width of cut and the bottom width of the cut respectively. Experimental investigations showed that during AWJM with different abrasives, the width of cut at the top of the slot was always greater than that at the bottom of the slots. It was explained by Wang et al., 1999 that as the abrasive particles move down the jet, they lose their kinetic energy and the relative strength zone of the jet is narrowed down. As a result, the width of cut at the bottom of the slot is smaller than that at the top. Influence of standoff distance (SOD) of the jet from the target material on the taper of cut during AWJM with different types of abrasives is illustrated in Fig. 16. It can be observed that the garnet abrasives produced the largest taper of cut followed by Al₂O₃ and SiC abrasives. Among the three types of abrasives used, SiC is the hardest material and consequently it retains its cutting ability as it moves down. Therefore, the difference between the widths at the top and bottom of the slot is small and consequently, the taper angle is also smaller. On the other hand, garnet abrasives lose their sharpness and as a result the bottom width becomes much narrower than the top width. Fig. 16 also shows that for all kinds of abrasives, the taper of cut increases with SOD. This is due to the divergence shape of the jet. As SOD is increased, the jet focus area also increases resulting increase in the width of cut.

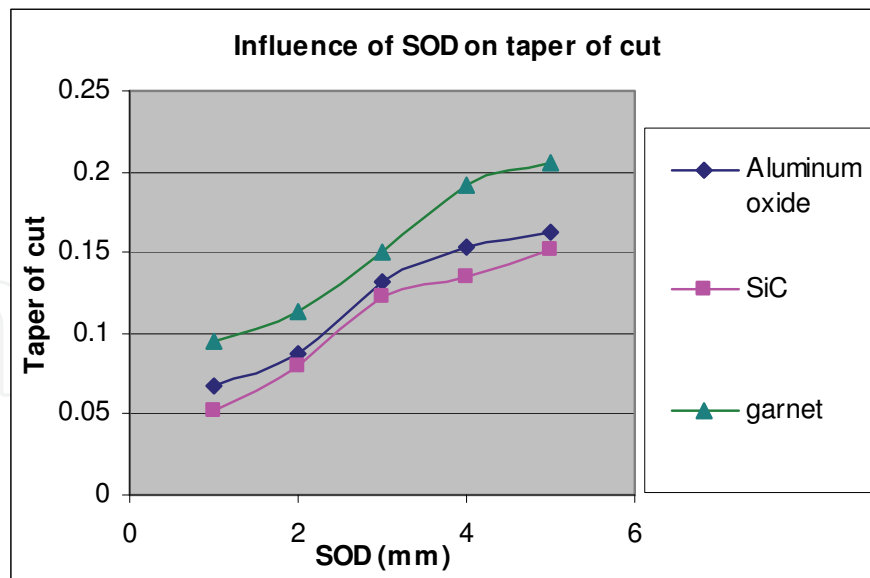

Fig. 16. Influence of SOD on taper of cut

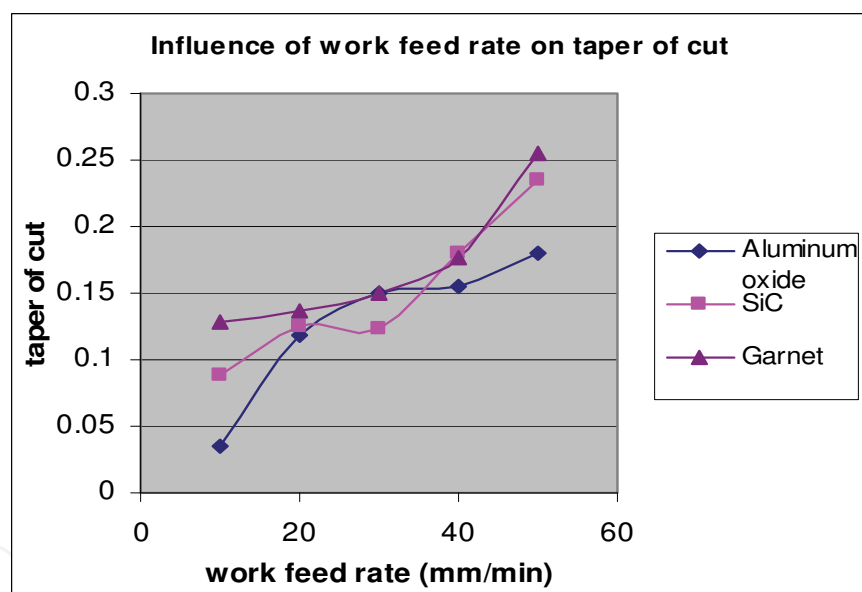

Fig. 17. Influence of feed rate on taper of cut

Fig. 17 shows the relationship between work feed rate and taper of cut during AWJM using different abrasive materials. For all types of abrasives the taper of cut shows an increasing trend with increase in work feed rate. With increase in work feed rate the machining zone is exposed to the jet for a shorter time. Cutting process is less effective at the jet exit that results an increase in taper of cut. Conner & Hashish, 2003 also found similar effect of feed rate on taper of cut during AWJM of aerospace materials using garnet abrasives. Garnet abrasives demonstrate a high taper of cut followed by SiC and Al_2O_3 .

Influence of pressure on taper of cut is illustrated in Fig. 18. Taper of cut decreases with increase in jet pressure for all the types of abrasives used. At a higher pressure the abrasives have higher energy and they retain their cutting ability as they move down from the jet

entrance to the jet exit. As a result, taper of cut reduces with increase in jet pressure. Louis et al., 2003 indicates some other positive aspects of using higher pressure. He found that the depth of penetration of the jet increases and cutting efficiency improves with increase in pressure. On the other hand, abrasive flow rate can be reduced if the jet pressure is increased. However, taper of cut is smaller for SiC abrasives followed by Al_2O_3 and garnet. SiC abrasives being harder than Al_2O_3 and garnet abrasives retain their sharp edges both at the entrance and the exit of the jet and produce the smallest width of cut. On the other hand, garnet abrasives being comparatively softer lose the sharpness of their cutting edges when they are near the jet exit.

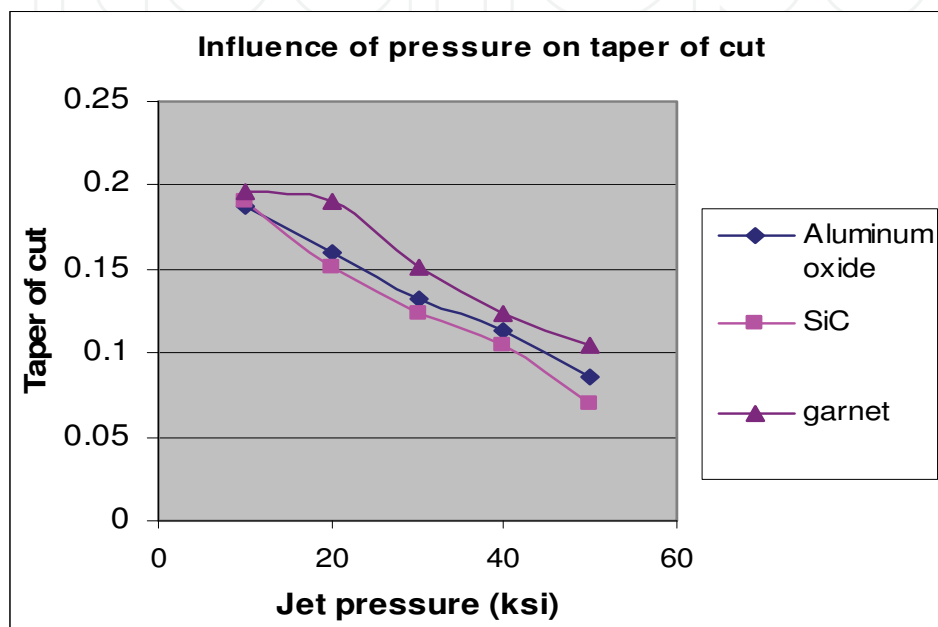

Fig. 18. Effect of pressure on taper of cut

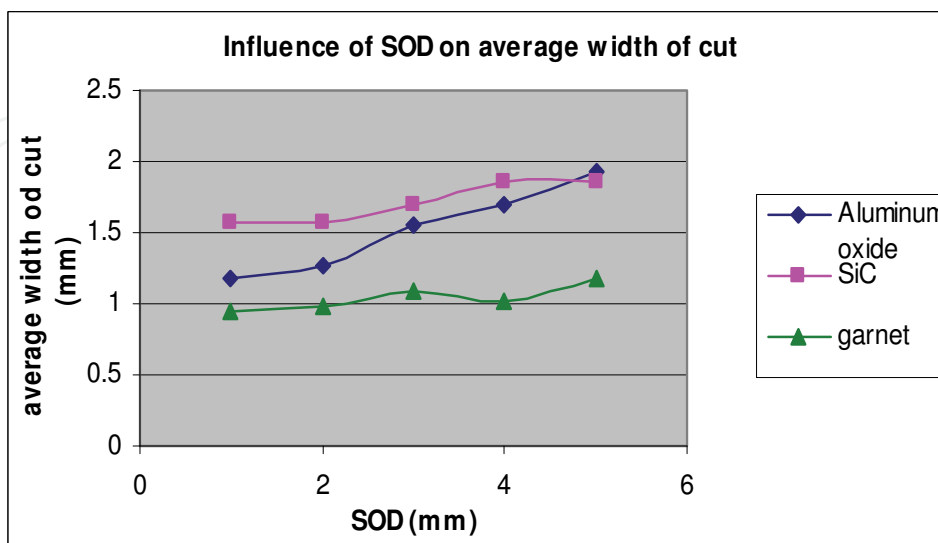

Fig. 19. Effect of SOD on taper of cut

5.3 Effect of different parameters on average width of cut

It has been established that though the abrasive water jet is a divergent one, the effective cutting zone of the jet is convergent, since the abrasives at the outer zone of the jet lose their kinetic energy. As a result, the width of cut at the jet entrance is always greater than the same at the jet exit. In Fig. 19 to Fig. 21 the average value of the widths of the jet entrance and jet exit has been taken as the width of cut. From Fig. 19 it is obvious that the average width of cut increases with increase in SOD which is due to the divergence shape of the jet. It was found that SiC produced the widest slot followed by Al_2O_3 and garnet. This is by virtue of higher hardness of SiC that enables more effective material removal.

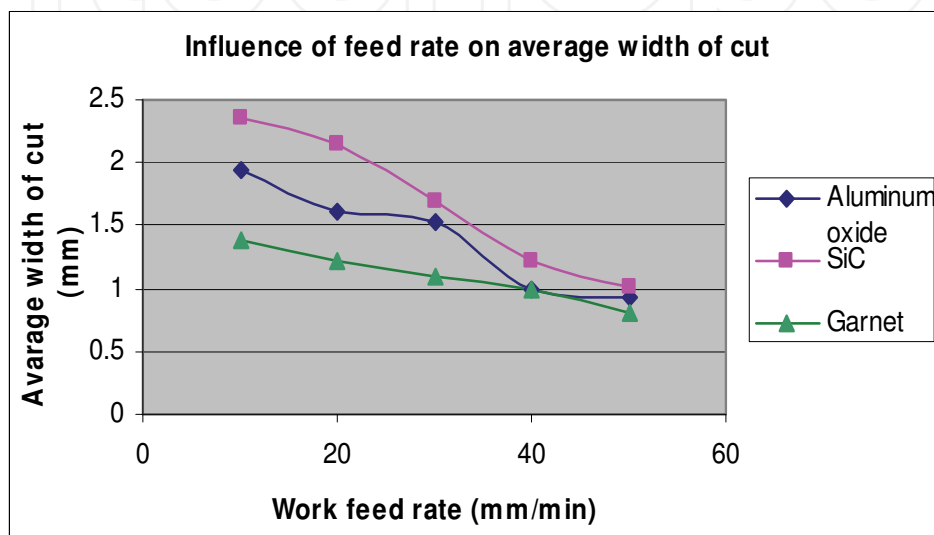

Fig. 20. Effect of feed on width of cut

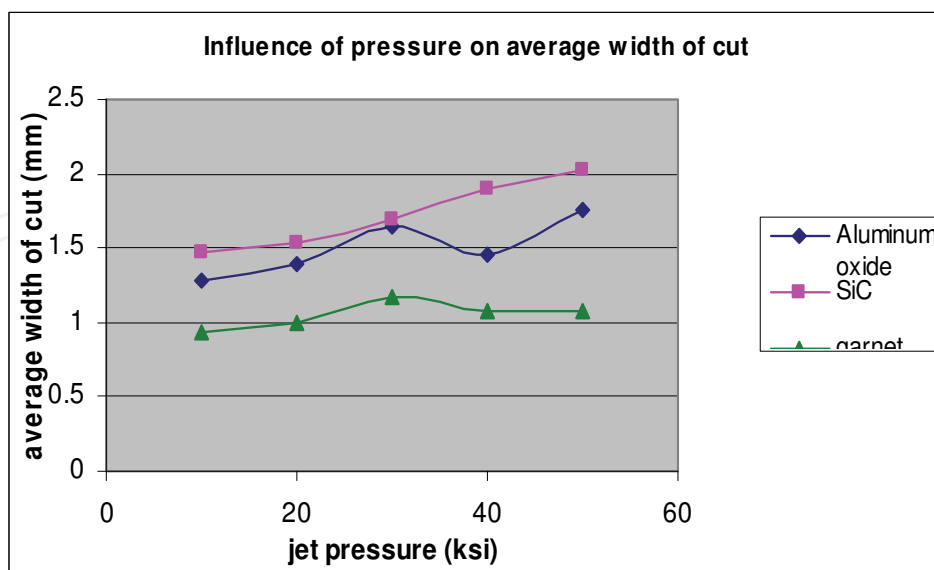

Fig. 21. Effect of pressure on width of cut

Influence of work feed rate on the average width of cut is illustrated in Fig. 20. Average width of cut decreases with increase in work feed rate since with the increase in feed rate the

work is exposed to the jet for a shorter period. The effect of pressure on average width of cut during AWJM is shown in Fig. 21. A higher pressure produces a jet of higher energy with capability of more effective cutting. From Fig. 19, Fig. 20 and Fig. 21 it was observed that in all the cases the average width of cut produced by SiC was higher than those produced by Al₂O₃ and garnet abrasives. It can be concluded that hardness is a key property of abrasive materials.

6. Conclusions

From the above discussions it can be concluded that during AWJM of carbides using SiC abrasives, machined surface roughness reduces if the jet pressure is increased. Surface smoothness deteriorates from the top of cut towards the exit of cut. The roughness of cut surface reduces with increase in abrasive flow rate since more abrasives are available per unit area of cut. The lower most zone of the cut surface is the most contaminated zone followed by the top most zone and the middle zone. Taper of cut increases with increase in SOD. Garnet abrasives produce a larger taper of cut followed by Al₂O₃ and SiC. This is due to higher hardness of SiC compared to Al₂O₃ and garnet. Taper of cut also increases with increase in work feed rate. But taper of cut reduces with increase in pressure. A higher pressure increases the kinetic energy of the abrasives and the divergence of the jet is reduced that causes a decrease in taper of cut. An increase in SOD increases the focus area of the jet and increases the average width of cut. But increase in feed rate reduces the average width of cut since the surface to be cut is exposed to the jet for a shorter time. A higher jet pressure increases the kinetic energy of the abrasive particles and enhances their cutting ability. As a result, increase in pressure causes increase in the average width of cut. SiC is harder than Al₂O₃ and garnet. As a result, its cutting ability is also higher than that of Al₂O₃ and garnet. Therefore, the average width of cut produced by SiC is higher than those produced by Al₂O₃ and garnet.

7. Acknowledgement

The authors of this work are indebted to the Research Management Center, International Islamic University Malaysia (IIUM) for its continuous help during the research work. The author is also grateful to Momber W. & Kovacevic, R. (1998), since some information has been taken from their book.

8. References

- Chen F., Patel K., Siores E. & Momber A. (2002). Minimizing particle contamination at abrasive water jet machined surfaces by a nozzle oscillation technique. *International Journal of Machine Tools & Manufacture*, Vol. 42, pp. 1385–1390, ISSN 0890-6955
- Chacko, V.; Gupta, A. & Summers, A. (2003). Comparative performance study of polyacrylamide and xanthum polymer in abrasive slurry jet, *Proceedings of American Water Jet Conference*, Houston, Texas, USA [3]
- Hocheng, H. & Chang, R. (1994). Material removal analysis in abrasive water jet cutting of ceramic plates. *Journal of Materials Processing Technology*, Vol. 40, pp. 287-304, ISSN 0924-0136

- Conner, I & Hashish, M. (2003). Abrasive water jet machining of aerospace structural sheet and thin plate materials. *Proceedings of American Water Jet Conference*, Houston, Texas, USA
- Kalpakjian, S. & Schmid, R. (2010). *Manufacturing Engineering and Technology*, Pentice Hall, ISBN 978-981-06-8144-9, Singapore
- Keyurkumar, P. (2004). Quantitative Evaluation of Abrasive Contamination In Ductile Material During Abrasive Water Jet Machining And Minimizing With A Nozzle Head Oscillation Technique. *International Journal of Machine Tools & Manufacture*, Vol. 44, pp. 1125-1132, ISSN 0890-6955
- Louis, H.; Mohamed, M. & Pude, F. (2003). Cutting mechanism and cutting efficiency for water pressures above 600 MPa. *Proceedings of American Water Jet Conference*, Houston, Texas, USA
- Momber, W.; Eusch, I & Kovacevic, R. (1996). Machining refractory ceramics with abrasive water jet. *Journal of Materials Science*, Vol. 31, pp. 6485-6493, ISSN 0022-2461
- Momber W. & Kovacevic, R. (1998). *Principles of Abrasive Water Jet Machining*, Springer, ISBN 3540762396, London
- Mort, A. (1995). Results of abrasive water jet market survey, *Proceedings of 8th American Water Jet Conference*, Vol. 1, pp. 259-289, Houston, Texas, USA
- Siores, E.; Chen, L.; Lemma, E. & Wang, J. (2006). Optimizing the AWJ Cutting Process of Ductile Materials Using Nozzle Oscillation Technique, *International Journal of Machine Tools & Manufacture*. Vol.42, pp. 781-789, ISSN 0890-6955
- Wang, J. & Wong, K. (1999). A study of abrasive water jet cutting of metallic coated sheet steel. *International Journal of Machine Tools and Manufacture*, Vol. 39, pp. 855-870, ISSN 0890-6955
- Waterjet machining tolerances, 2011, Available from <http://waterjets.org>

IntechOpen

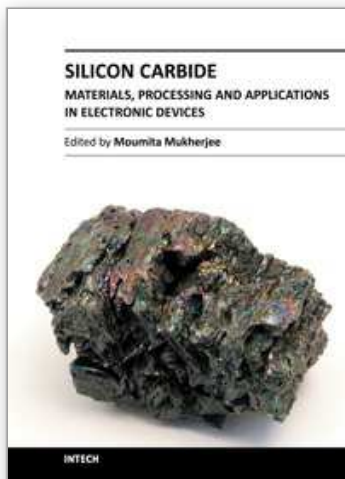

Silicon Carbide - Materials, Processing and Applications in Electronic Devices

Edited by Dr. Moumita Mukherjee

ISBN 978-953-307-968-4

Hard cover, 546 pages

Publisher InTech

Published online 10, October, 2011

Published in print edition October, 2011

Silicon Carbide (SiC) and its polytypes, used primarily for grinding and high temperature ceramics, have been a part of human civilization for a long time. The inherent ability of SiC devices to operate with higher efficiency and lower environmental footprint than silicon-based devices at high temperatures and under high voltages pushes SiC on the verge of becoming the material of choice for high power electronics and optoelectronics. What is more important, SiC is emerging to become a template for graphene fabrication, and a material for the next generation of sub-32nm semiconductor devices. It is thus increasingly clear that SiC electronic systems will dominate the new energy and transport technologies of the 21st century. In 21 chapters of the book, special emphasis has been placed on the ‘materials’ aspects and developments thereof. To that end, about 70% of the book addresses the theory, crystal growth, defects, surface and interface properties, characterization, and processing issues pertaining to SiC. The remaining 30% of the book covers the electronic device aspects of this material. Overall, this book will be valuable as a reference for SiC researchers for a few years to come. This book prestigiously covers our current understanding of SiC as a semiconductor material in electronics. The primary target for the book includes students, researchers, material and chemical engineers, semiconductor manufacturers and professionals who are interested in silicon carbide and its continuing progression.

How to reference

In order to correctly reference this scholarly work, feel free to copy and paste the following:

Ahsan Ali Khan and Mohammad Yeakub Ali (2011). Application of Silicon Carbide in Abrasive Water Jet Machining, Silicon Carbide - Materials, Processing and Applications in Electronic Devices, Dr. Moumita Mukherjee (Ed.), ISBN: 978-953-307-968-4, InTech, Available from: <http://www.intechopen.com/books/silicon-carbide-materials-processing-and-applications-in-electronic-devices/application-of-silicon-carbide-in-abrasive-water-jet-machining>

INTECH
open science | open minds

InTech Europe

University Campus STeP Ri
Slavka Krautzeka 83/A
51000 Rijeka, Croatia
Phone: +385 (51) 770 447

InTech China

Unit 405, Office Block, Hotel Equatorial Shanghai
No.65, Yan An Road (West), Shanghai, 200040, China
中国上海市延安西路65号上海国际贵都大饭店办公楼405单元
Phone: +86-21-62489820

www.intechopen.com

Fax: +385 (51) 686 166
www.intechopen.com

Fax: +86-21-62489821

IntechOpen

IntechOpen

© 2011 The Author(s). Licensee IntechOpen. This is an open access article distributed under the terms of the [Creative Commons Attribution 3.0 License](#), which permits unrestricted use, distribution, and reproduction in any medium, provided the original work is properly cited.

IntechOpen

IntechOpen