

We are IntechOpen, the world's leading publisher of Open Access books Built by scientists, for scientists

4,800

Open access books available

122,000

International authors and editors

135M

Downloads

Our authors are among the

154

Countries delivered to

TOP 1%

most cited scientists

12.2%

Contributors from top 500 universities



WEB OF SCIENCE™

Selection of our books indexed in the Book Citation Index
in Web of Science™ Core Collection (BKCI)

Interested in publishing with us?
Contact book.department@intechopen.com

Numbers displayed above are based on latest data collected.
For more information visit www.intechopen.com



Integrating Micro-Photonic Systems and MOEMS into Standard Silicon CMOS Integrated Circuitry

Lukas W. Snyman

*Silicon Photonics Group, Laboratory of Innovative Electronic Systems,
Department of Electrical Engineering, Tshwane University of Technology (TUT),
Pretoria,
South Africa*

1. Introduction

Various researchers have highlighted the integration of small-dimension, optical communication- and micro-systems into mainstream silicon fabrication technology (Bourouina et al 1996; Clayes, 2009; Fitzgerald & Kimerling, 1998; Gianchandani, 2010; Robbins, 2000; Soref, 1998). The realization of sufficiently efficient light-emitters have, been a major technological challenge.

A research area, known as "Silicon Photonics", has emerged in recent years (Kubby and Reed, 2005-2010; Savage 2002; Wada, 2004). This technology offers the advanced processing of data at ultra high speeds and provides advanced optical signal processing. It can analyse diverse optical data directly on chip, and may even contribute towards solving the interconnect density problem, associated with current microprocessor systems. Until now, this technology has been primarily established at 1550 nm. The reason is to conform with the main long haul and low loss telecommunication bands. The realization of waveguides, modulators, resonators, filters etc. on silicon platforms has been achieved until now with relative ease by using mainly Silicon-on-Insulator (SOI) technology.

Two main application fields have been developed, namely (1) high speed optical communication with modulation speeds and bandwidths reaching up to THz, utilizing Si-Ge technology, and (2) the so-called "Lab on chip" approach, where the main goal is the realization of an optical micro-system, which can perform certain analysis of the environment or attached media.

In the absence of an efficient light source at 1550 nm on a chip, these systems operate currently with external light sources. They also incorporate Si-Ge detectors, which are not compatible with mainstream silicon technology (Beals et al, 2008; Lui et al, 2010; Wada, 2004). The integration of germanium into silicon structures requires the addition of complex and very expensive processing procedures. Recently, a Ge-on-Si laser source was announced by Lui et al. in 2010. This technology provides coherent optical emission on a chip, but utilizes quite complex strained Si-Ge layer technology.

Making use of adequately emitting Complementary Metal Oxide Semiconductor (CMOS) optical sources, together with good silicon detectors, shows good potential to manufacture diverse new optical communication and integrated systems directly onto CMOS silicon

chips. The optical communication bandwidth of these systems may not necessarily compete with that of Si-Ge technology, but it still could take a substantial market share when the benefits of an all silicon and CMOS compatible systems are considered. These benefits are, mainly, (1) lower complexity of the technology; (2) lower cost of fabrication; (3) ease of integration into the mainstream CMOS technology; and (4) higher system integration capabilities.

The realization of micro-photonic systems on CMOS chips can lead to many new products and markets in the future. Achieving these goals can lead to low cost “all-silicon” optoelectronic based technologies and so-called “smarter” and more “intelligent” CMOS chips. Envisaged systems could range from CMOS based micro-systems, analyzing environmental or bio-logical substances to sensors on chips, which can detect vibration,, inertia and acceleration. Whole new products, aimed at the medical and biological market could be developed and sensor systems, which could measure colour, optical intensities, absorption, and distances (including metrology) . Such a new field could be appropriately nomenclated “Silicon CMOS Photonics”.

Propagation wavelength (nm)	Optical source	Waveguide technology	Detectors	Complexity (10)	Estimated cost to implement (10)
450	Available	Not available	Available	10	8
750 - 850	Available	Challenges	Available	3	2
1100	Available	Available	Not available	8	10
1500	Available	Available	Not available	8	10

Table 1. Comparison of optical source, waveguide and optical detector technologies for generating new micro-photonic systems in CMOS integrated circuit technology.

Table 1 summarizes the current options for integrating photonic systems into CMOS technology with regard to optical source, waveguide, detector technology and complexity. The composition of the table is based on the presentation of results in the field at recent international conferences (SPIE Photonic West 2009,2010).

The analysis shows, that if efficiently enough waveguides could be developed in the wavelength regime of 750-850 nm, both optical sources and detectors could be completely compatible with CMOS technology. The waveguide technology at these wavelengths faces some major challenges, as very little research and development work has been done in this field. The operating wavelength would be about one half of that of 1550 nm, which is currently the wavelength for long haul communication systems. This wavelength could still very effectively link with the current wide bandwidth 850 nm local area network technology.

In this chapter, research results are presented with regard to the following : (1) The optical compatibility of silicon CMOS structures. (2) The current state of the art technology of optical sources at submicron wavelengths, that are compatible with mainstream CMOS technology. (3) Development capabilities of waveguides in the 750 - 850 nm wavelength regime utilising CMOS technology. (4) “Proof of concept” of optical communication systems that utilize “all silicon CMOS components “. (5) Finally, the development of CMOS based micro-photonic systems using CMOS technology in the 650 - 850 nm wavelength regime.

2. Optical compatibility of CMOS technology

First, the capability of CMOS technology is evaluated to accommodate optical propagation in micro-phonic systems. An investigation of the CMOS structure, as in Fig. 1, (Fullin et al., 1993), shows that the field oxide, the inter-metallic oxide, and the silicon nitride (Si_3N_4) passivation layer are all optical transparent and can serve as “optical propagation and/or optical coupling structures” in CMOS integrated circuitry.

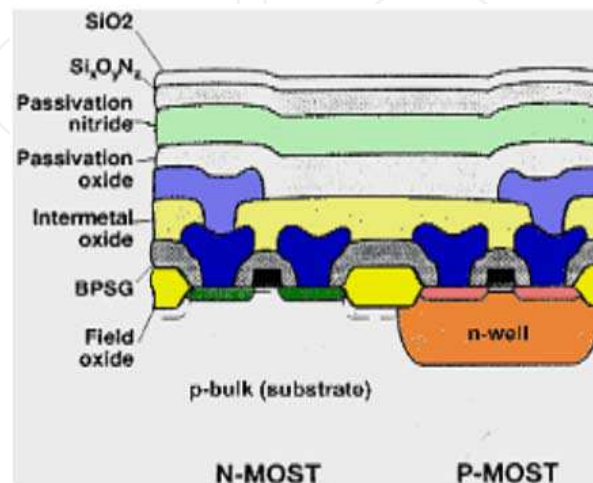

Fig. 1. Schematic diagram displaying a typical structure used in field oxide based CMOS integrated circuit technology. Layers that are optically transparent below 1 μm are shown in yellow, green and grey . Bright yellow: Native silicon dioxide; Yellow: intermetallic oxide; White: Passivation oxide ; Green: Silicon nitride.

Field oxide, used for electrical isolation between MOSFET transistors by older CMOS processes, is formed by oxidation of silicon. This results in a high quality “glassy” layer of superb optical transmission with a refractive index of 1.46. A drawback is that this layer is bonded at the bottom to a highly absorptive silicon substrate with a refractive index of 3.5 and a very high absorption coefficient for all optical radiation below 950 nm. It is anticipated to use this layer as medium to transport optical radiation vertically outward from Si Avalanche based Light Emitting Diodes (Si AvLEDs), which are situated at the silicon-overlayer interface (Snyman et al. , 2009). The specific structure associated with the field oxide, favours simple convex lensing for outward directed vertical optical radiation. Fig. 2 demonstrates the concept obtained by structural analysis and ray tracing.

The inter-metallic oxide, positioned between metallic layers, are CVD plasma deposited and mainly used as electrical isolation between the metal layers. Literature surveys (Beals et al , 2008, Gorin et al, 2008 show that, even so, these layers are porous, they offer suitable propagation for the longer mid infra-red wavelengths, where structural defects, such as porosity, grain boundaries and side wall scattering due to roughness play a lesser role . The metallic layers bonding to the oxide inter-metallic oxide layers can be used as effective reflectors or optical confinement layers.

The oxide which is deposited on top of the metal layers serves as a pre-passivation step prior to the final passivation by silicon nitride. This layer could be used for the propagation of mid infrared wavelengths.

The silicon nitride layer possesses interesting optical properties. One main advantage is that the refractive index is higher than that of the surrounding plasma oxide layers. Depending on the composition and deposition technology, its refractive index can be varied between 1.9

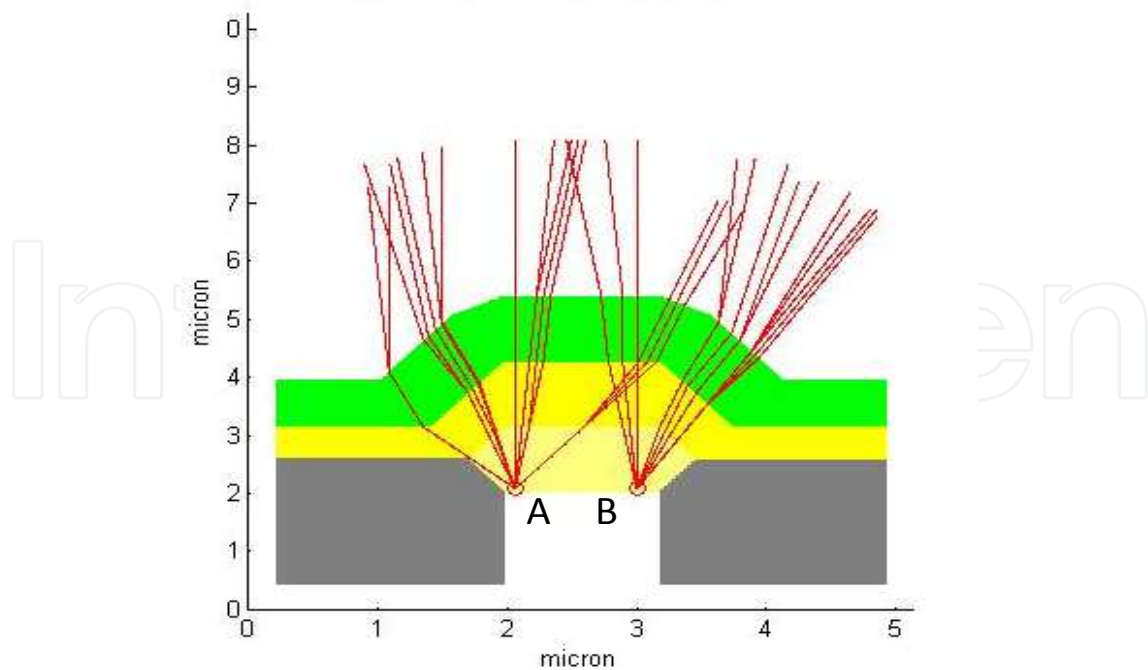

Fig. 2. Optical propagation phenomenon at 750nm in CMOS over layers using simple ray tracing techniques. The layer color indexing is the same as in Fig.1.

and 2.4. This layer, when surrounded by silicon oxide, is ideal for waveguiding optical radiation laterally in the CMOS structure. Since this layer, too, is created by the CVD process, is porous and has a rough surface. Therefore, it is anticipated to use this layer for the propagation of longer wavelengths. Fig. 3 demonstrates this concept.

Optically transparent layers made of polymer or silicon oxo-nitride can be deposited on top of the CMOS layers with relative ease by means of suitable post processing procedures. Since these layers are deposited at low temperatures, they can be subjected to further procedures to generate sloped or lens like structures in the final outer layer CMOS structure. Recently, at the SPIE Photonic West Trade Show in San Francisco, it was reported that RF etching and other technologies exist to pattern such layers with up to 150 steps using appropriate software and process technology (Tessera, 2011).

CMOS processes below 350 nm utilize a planarization process after the MOSFET transistor fabrication. They deposit up to six metal layers on top of these layers, where sloping of these layers is caused by the thicker outer metal layers (Foty, 2009, Sedra, 2004). However, this technology uses trench isolation for electrically isolating n- and p MOSFETS laterally in the CMOS structure. The trench- isolation technology opens up interesting optical properties. Trenches are spatially defined. This implies that light emitters can be fabricated in the CMOS structure at certain areas which are laterally bounded by isolation trenches or deep crevasses in the silicon. It hence follows that, if these trenches could be filled with an optical material of higher refractive index, optical radiation emitted from the silicon-overlayer interface, could then be coupled with high efficiency directly into adjacent optical channels. The current CMOS technology can create a thin oxidation layer that is used as isolation layer in the trench technology. If this layer can be enhanced and is followed by a layer of high refractive index material such as silicon nitride, interesting lateral optical conductors or waveguides can be constructed at the silicon-overlayer interface. Some of these concepts are illustrated in Fig. 4 and Fig 5 (Snyman 2010d) (Snyman and Foty, 2011a).

Since certain optical sources can only be fabricated at the silicon-overlayer interface in the CMOS structure (such as Si-avalanche LED technology), coupling of optical radiation from the silicon-overlayer interface to the outer CMOS surface layers needs to be investigated. Analysis conducted has shown, that by applying special CMOS layer definition techniques and positioning these layers under 45 degree, structures can be generated which couple the optical radiation from the silicon substrate to the over layers. Fig. 3 illustrates this concept. Additional structures can be designed to ensure nearly 100 % coupling into the silicon nitride layer.

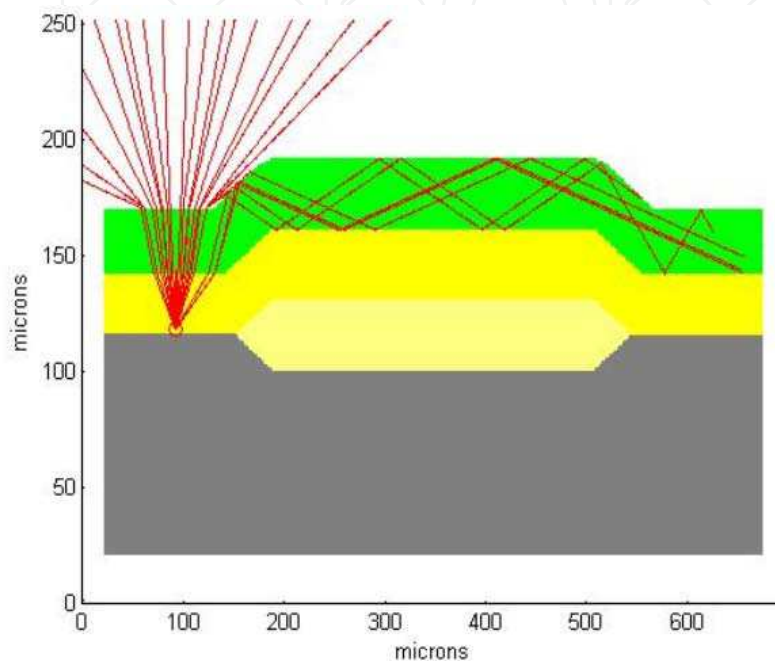

Fig. 3. Optical propagation phenomenon at 750nm in CMOS over layers using simple ray tracing techniques. The layer color indexing is the same as in Fig.1. Waveguiding of radiation along the silicon nitride overlayer is demonstrated.

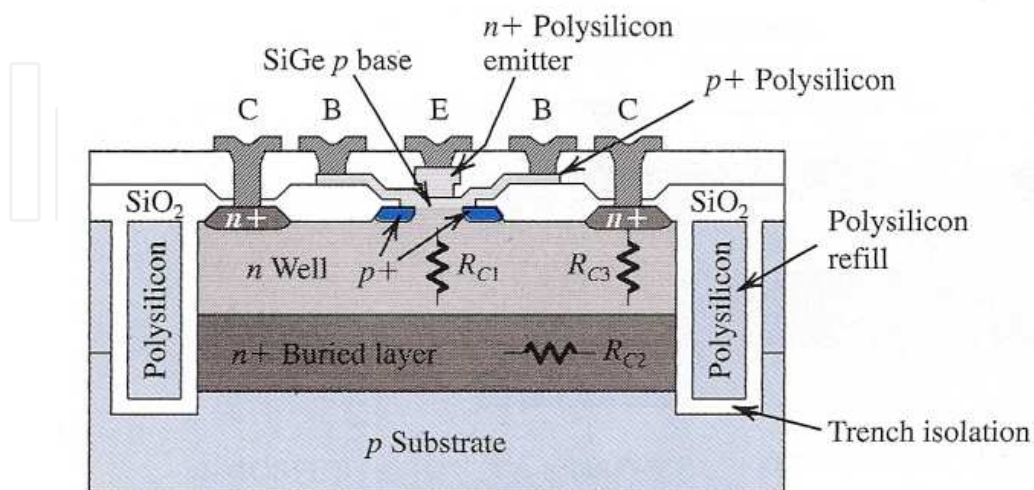

Fig. 4. Components and structural layout of the latest CMOS processes utilising isolation trench based technology (Sedra, 2004).

This implies that photonic system structures can be generated in CMOS technology which incorporate so called “multi-planing”, where optical radiation can be coupled from one plane to the next. Obviously, the concepts described here are still in its infancy, and further research is necessary. Both standard CMOS as well as Silicon-on-Insulator (SOI) technology are suitable to realise some of the concepts.

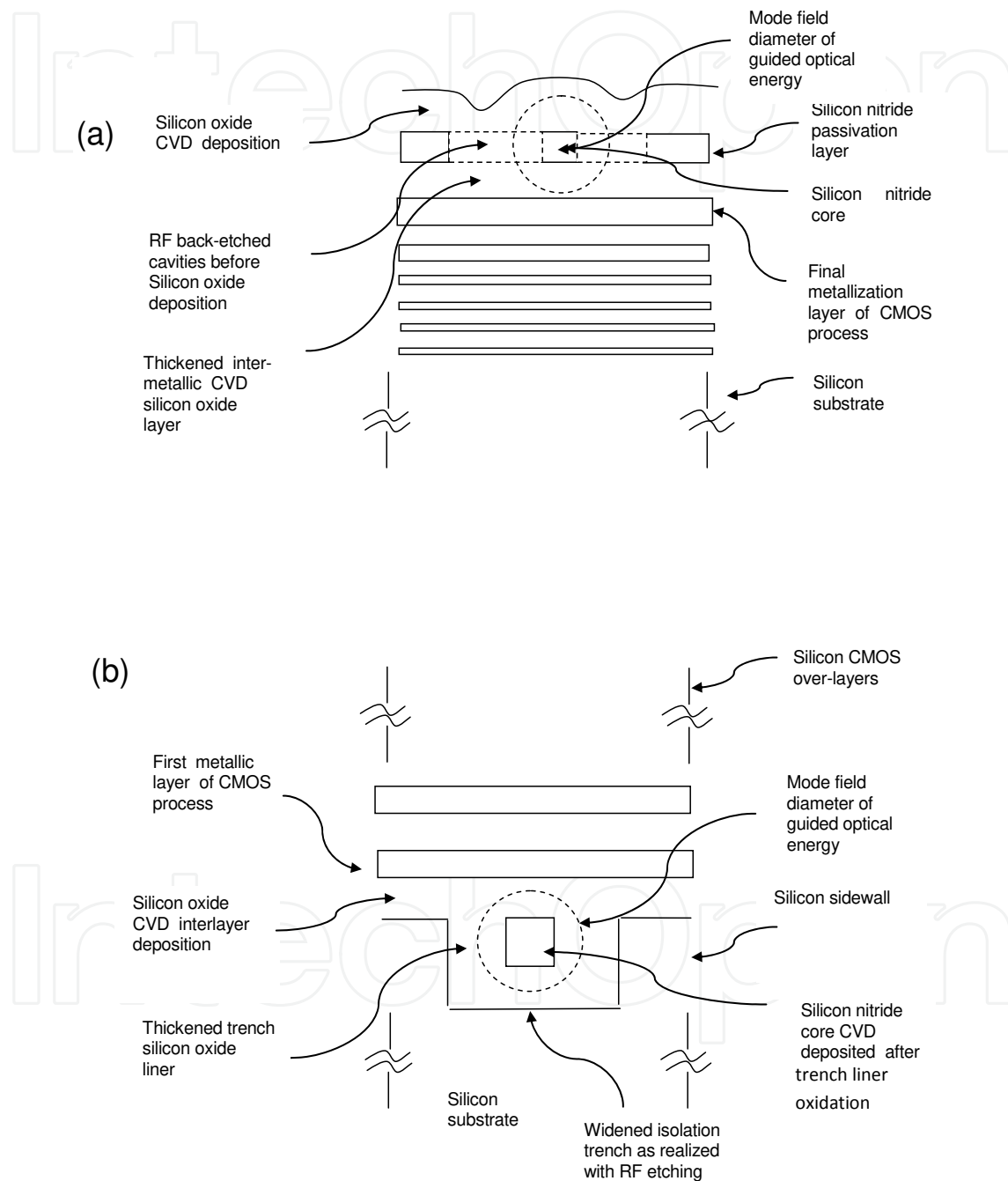

Fig. 5. Cross-sectional profiles of possible wave guides that can be constructed by modification of existing CMOS processes. (a) Waveguide structure fabricated by post processing procedures in the overlayers. (b) Trench based waveguide structure with silicon nitride embedded in silicon oxide.

3. Viable optical sources for all- silicon CMOS technology

The availability of optical sources suitable for integration into CMOS technology is evaluated. A survey reveals that a number of light emitters have been developed since the nineties that can be integrated into mainstream silicon technology. They range from forward biased Si p-n LEDs which operate at 1100 nm (Green et al, 2001; Kramer et al 1993; Hirschman et al 1996); avalanche based Si LEDs which operate in the visible from 450 – 650 nm (Brummer et al, 1993; Kramer et al 1993; Snyman et 1996- 2006); organic light emitting diodes (OLED) incorporated into CMOS structures which also emit in the visible (Vogel et al., 2007); to, strained layer Ge-on-licon structures radiating at 1560 nm (Lui, 2010). Fig. 6 illustrates the spectral radiance versus wavelength for a number of these light sources as found in various citations.

Forward biased p-n junction LEDs and Ge-Si hetero-structure devices emit between 1100 and 1600 nm. This wavelength range lies beyond the band edge absorption of silicon, and all silicon detectors respond only weakly or not at all to this radiation. Hence, these technologies are not viable for the development of only silicon CMOS photonic systems. The Ge-Si hetero-structure can be realized in Si-Ge CMOS processes, but increases complexity and costs.

Organic based Light Emitting Diodes (OLED) utilize the sandwiching of organic layers between doped silicon semiconductor layers with high yields between 450 and 650 nm (Vogel et al , 2007). In spite, the incorporation of foreign organic materials through post-processes this technology is a viable option. The photonic emission levels are quite high, up to 100 cd m⁻² at 3.2 V and 100 mA cm⁻². The organic layers must be deposited and processed at low temperature. This technology is, therefore, particularly suited for post processing, and as optical sources in the outer layers of the CMOS structures. A major uncertainty with regard to this technology is the high speed modulation capability of these devices.

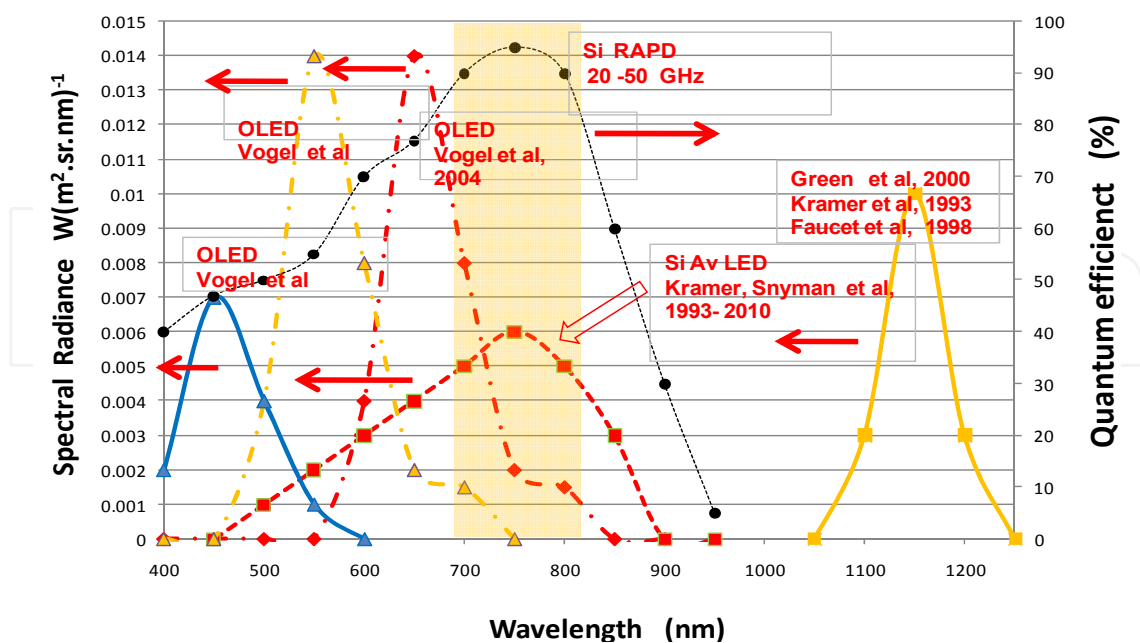

Fig. 6. Spectral radiance characteristics of Organic Light Emitting Devices (OLEDs and Si avalanche-based light emitting device (Si Av LED), and comparison with the spectral detection range of reach through avalanche detector (RAPD) devices.

Si avalanche light emitting devices in the 450 – 650 nm regime have been known for a long time (Newman 1955; Ghynoweth et al, 1956)]. The fabrication of these devices is high temperature compatible and can be used in standard silicon designs. Viable CMOS compatible avalanche Si LEDs (Si CMOS Av LEDs) have emerged since the early 1990's. Kramer & Zeits (1993) were the first to propose the utilization of Si Av LEDs inside CMOS technology. They illustrated the potential of this technology. Snyman et al (1998-2005) have realized a series of very practical light emitting devices in standard CMOS technology, such as micro displays and electro-optical interfaces, which displayed higher emission efficiencies as well as higher emission radiances (intensities). Particularly promising results have been obtained regarding efficiency and intensity, when a combination of current density confinement, surface layer engineering and injection of additional carriers of opposite charge density into the avalanching junction, were implemented (Snyman et al., 2006 - 2007). These devices showed three orders of increase in optical output as compared with previous similar work. However, increases in efficiency seemed to be compromised by higher total device currents; because of loss of injected carriers, which do not interact with avalanching carriers. Du Plessis and Aharoni have made valuable contributions by reducing the operating voltages associated with these devices (2000, 2002).

Fig. 7 presents an example of an electro-optical interface that was developed by Snyman et al. in association with the Kramer- Seitz group in 1996 in Switzerland and which offered very high radiance intensity (approximately 1 nW) in spot areas as small as $1 \mu\text{m}^2$.

The latest analysis of the work of Kramer et al and Snyman et al (Snyman et al, 2010), shows that, particularly, the longer wavelength emissions up to 750 nm can be achieved by focusing on the electron relaxation techniques in the purer n-side of the silicon p-n avalanching junctions. This development has a very important implication. The spectral radiance of this device compares extremely well with the spectral detectivity of the silicon reach through avalanche photo detector (RAPD) technology. A particular good match is obtained between the emission radiance spectrum of this device and the detectible spectrum of a RAPD (see Fig. 6).

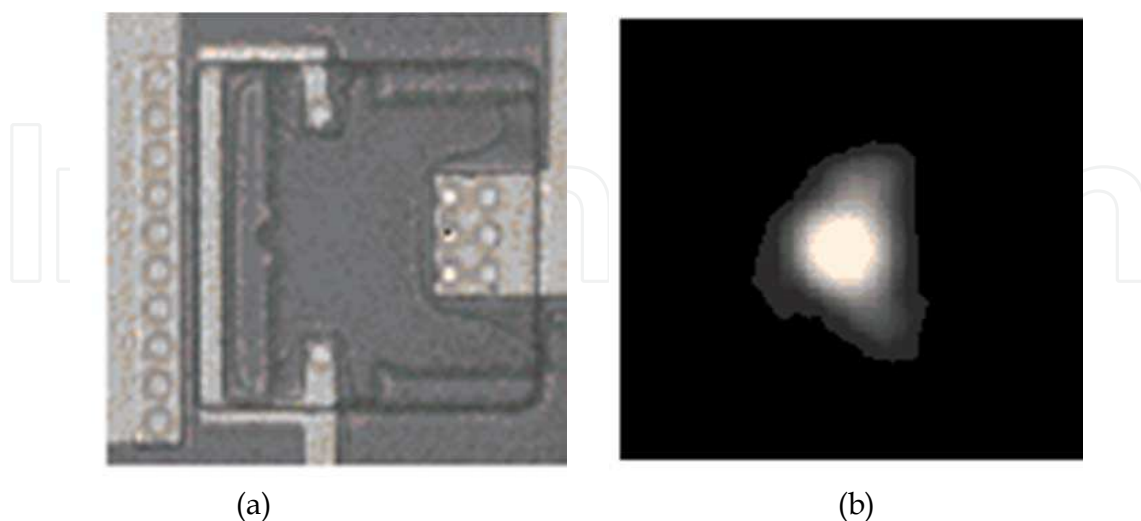

Fig. 7. Si avalanche-based light emitting device (Si Av LED) and electro-optical interfaces realized in $1.2 \mu\text{m}$ Si CMOS technology with standard CMOS design and processing procedures (Snyman, 1996). (a) Top view with bright field optical microscopy. (b) Optical emission characteristics in dark field conditions

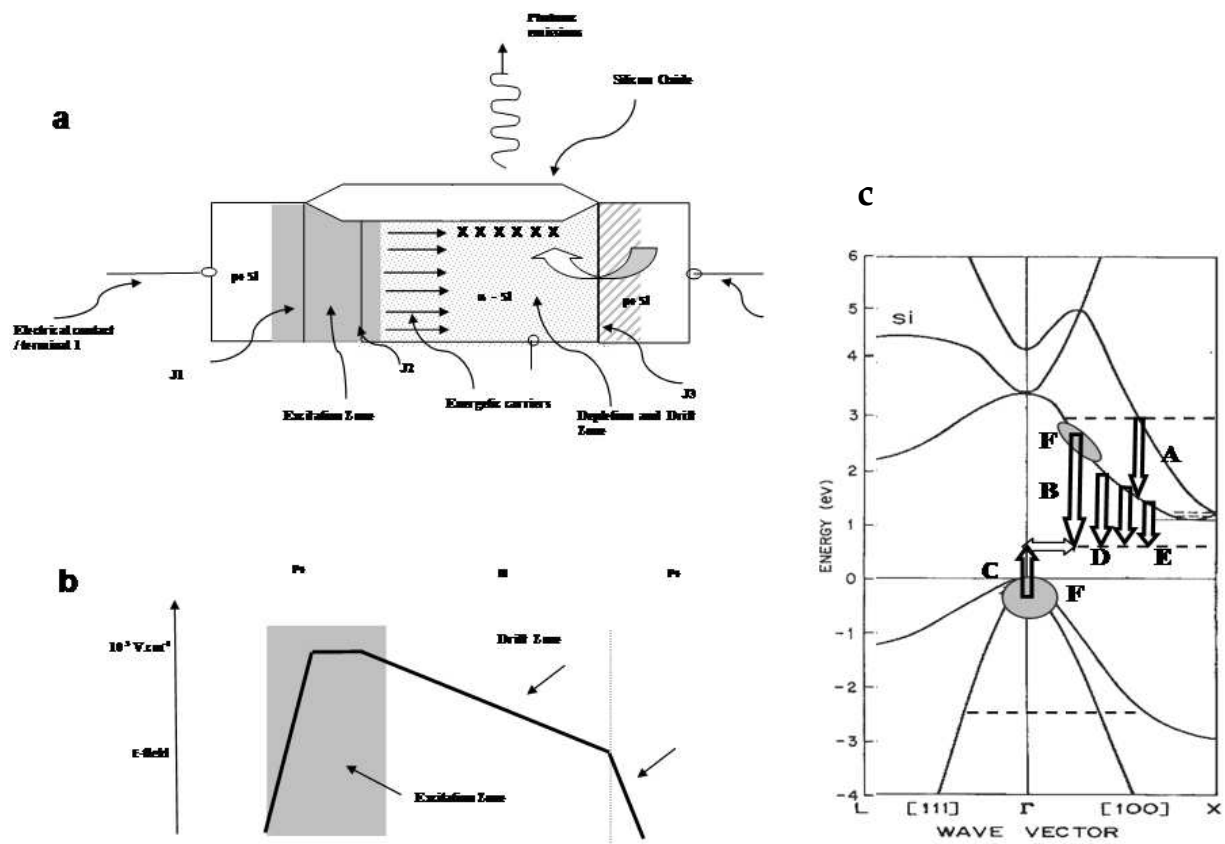

Fig. 8. Schematic diagram showing the operation principles of a Si avalanche-based light emitting device (Si Av LED) and electro-optical interface. (a) Structure of the device. (b) Electric field profile through the device and , (c), nature of photonic transitions in the energy band diagram for silicon .

Fig. 8 represents some of the latest in house designs with regard to a so called “modified E-field and defect density controlled Si Av LED”. Only a synopsis is presented here and more details can be found in recent publications (Snyman and Bellotti, 2010a). The device consists of a p⁺-i-n-p⁺ structure with a very thin lowly doped layer between the p⁺ and the n layer. The purpose of this layer is to create a thin but elongated electric field region in the silicon that will ensure a number of diffusion multiplication lengths in the avalanche process. The excited electrons loose their energies mainly in the n-type material through various intra-band and inter-band relaxation processes. If the p⁺-n junction at the end of the structure is slightly forward biased and a large number of positive low energy holes is injected into the n-region, these holes can then interact with these high energy electrons . This enhances the recombination probability between high energetic electrons and low energy holes.

The recombination process can be further enhanced by inserting a large number of surface states at the Si-SiO₂ interface in the n-region. This can cause a “momentum spread” in the n-region for both, the energetic electrons as well as the injected holes. Fig. 8 (c) presents the photonic transitions that are stimulated by this design. Excited energetic electrons from high up in the conduction band may relax from the second conduction band to the first conduction band. Energetic electrons excited by the ionization processes may interact and relax to defect states which are situated in the mid-bandgap level between the conduction band and the valence band. The maximum density distribution (electrons per energy levels) is around 1 to 1.8 eV (Snyman 2010a) , and relaxation to mid-bandgap defect states will

cause a spread of light emission energies from 0.1 eV to 2.3 eV, with maximum transition possibilities between 1.5 eV and 2.3 eV. By controlling the defect density in this device, one can favour either the 650 nm or 750 nm emissions. Total emission intensities of up to 1 μW per 5 μm^2 area at the Si-SiO₂ interface have recently been observed (Snyman and Bellotti, 2010a). Further improvement is currently underway in order to increase particularly the longer wavelength emissions associated with these structures.

In summary, particularly promising about the application of Si Av LEDs into CMOS integrated systems, is the following :

- Si Av LEDs can emit an estimated 1 μW inside silicon and at compatible CMOS operating voltages and currents (3-8 V, 0.1- 1 mA) they can emit up to 10 nW / μm^2 at 450 -750 nm (Snyman and Bellotti, 2010a; Snyman 2010b; Snyman 2010c).
- They can be realized with great ease by using standard CMOS design and processing procedures, vastly reducing the cost of such systems.
- The emission levels of the Si CMOS Av LEDs are 10^{+3} to 10^{+4} times higher than the detectivity of silicon p-i-n detectors, and hence offer a good dynamic range in detection and analysis.
- These types of devices can reach very high modulation speeds, greater than 10 GHz, because of the low capacitance reverse biased structures utilised (Chatterjee, 2004).
- They can be incorporated in the silicon-CMOS overlayer interface, because they are high temperature processing compatible.
- They can emit a substantial broadband in the mid infrared region (0.65 to 0.85 μm). Particularly, p+n designs emit strongly around 0.75 μm (Kramer 1993, Snyman 2010a).

4. Development of CMOS optical waveguides at 750nm

The development of efficient waveguides at submicron wavelengths in CMOS technology faces major challenges, particularly due to alleged higher absorption and scattering effects at submicron wavelengths.

A recent analysis shows that both, silicon nitride and Si oxi-nitride, transmitting radiation at low loss between 650 and 850 nm (Daldossa et al., 2004; Gorin et al., 2008). Both, Si O_x N_y and Si_x N_y possess high refractive indices of 1.6 - 1.95 and 2.2 - 2.4 respectively, against a background of available SiO₂ as cladding or background layers in CMOS silicon.

Subsequently, a survey was conducted of the optical characteristics of current CVD plasma deposited silicon nitrides that can be easily integrated in CMOS circuitry. In Fig. 9, the absorption coefficients versus wavelength are given for three types of deposited silicon nitrides. The first curve corresponds to the normal high frequency deposition of silicon nitride used in CMOS fabrication. The results were published by Daldossa et al., 2004. The second curve corresponds to a low frequency deposition process as recently developed by Gorin et al (2008). The third curve corresponds to a special low frequency process followed by a low temperature "defect curing" technique as developed by Gorin et al. This process offers superb low loss characteristics. These results are extremely promising, and calculations show that, with this technology, very low propagation losses of 0.5 dB cm⁻¹ at around 750 nm can be achieved when combined with standard CMOS technology. This wavelength falls into the maximum detectivity range of state-of-the-art reach-through avalanche silicon photo detectors (Si-RAPDs).

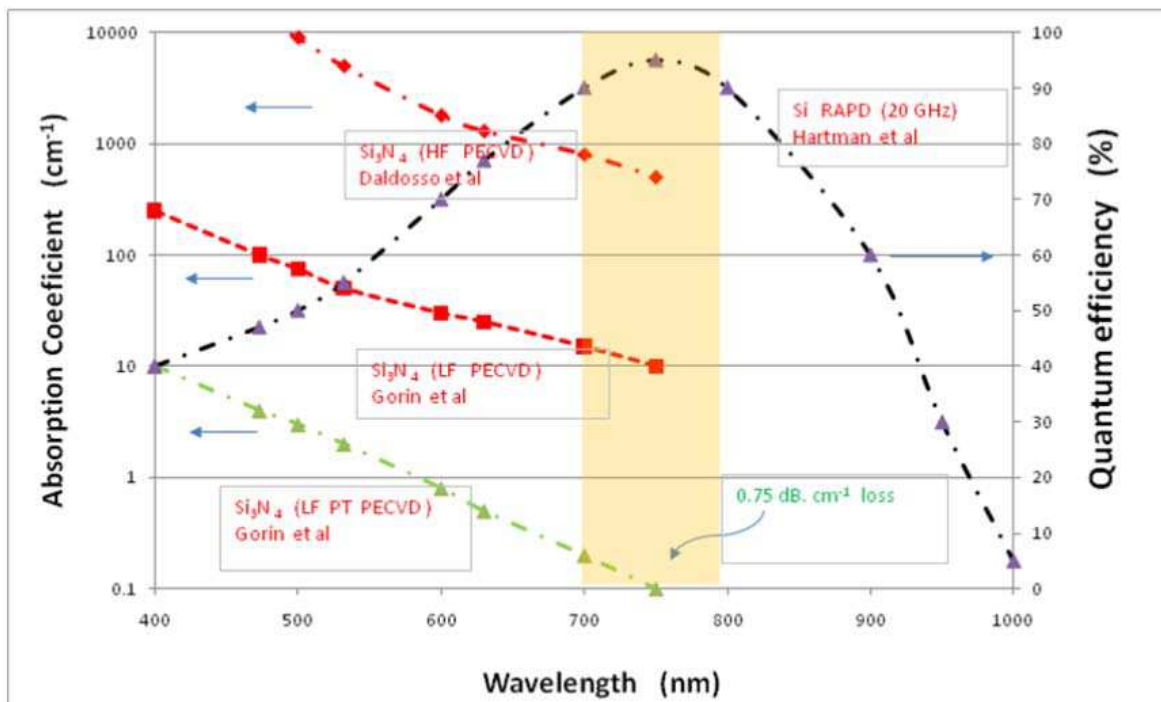

Fig. 9. Analyses of the loss characteristics of plasma deposited silicon nitride versus propagation wavelength and comparison with the detectivity of CMOS compatible reach through avalanche detectors.

Optical simulations were performed with RSOF (BeamPROP and FULL WAVE) to design and simulate specific CMOS based waveguide structures operating at 750 nm, using CMOS materials and processing parameters. First, simple lateral uniform structures were investigated with no vertical and lateral bends and with a core of refractive index ranging from $n = 1.96$ (oxi-nitride) to $n = 2.4$ (nitride). The core was surrounded by silicon oxide ($n = 1.46$).

The analysis showed that both, multimode as well as single mode waveguiding can be achieved in CMOS structures. Fig. 10 and Fig.11 illustrate some of the obtained results.

Fig. 10 shows a three dimensional view of the electrical field along the 0.6 μm diameter silicon nitride waveguide. Multi-mode propagation with almost zero loss is demonstrated as a function of distance over a length of 20 μm . Multi-mode propagation in CMOS micro-systems has the following advantages: (1) a large acceptance angle for coupling optical radiation into the waveguide; (2) exit of light at large solid angles at the end of the waveguide; (3) allowing narrow curvatures in the waveguides; and (4) more play in dimensioning of the waveguides. (1) and (2) are particularly favourable for coupling LED light into waveguides.

Fig. 11 shows the simulation of a 1 μm diameter trench-based waveguide with an embedded core layer of 0.2 μm radius silicon nitride in a SiO_2 surrounding matrix. The two dimensional plot of the electrical field propagation along the waveguide as shown in Fig. 11 (a) reveals single mode propagation. The calculated loss curve in the adjacent figure (b), shows almost zero loss over a distance of 20 μm in Fig 11(b). Fig. 12(a) displays the transverse field in the waveguide perpendicular to the axis of propagation. Using the value of the real part of the propagation constant, as derived in the simulation, an accurate energy loss could be calculated using conventional optical propagation. With the imaginary part of the refractive index, as predicted by RSOF, a low loss propagation of 0.65 dB cm^{-1} is found, taking the material properties into account, as used by the RSOF simulation program.

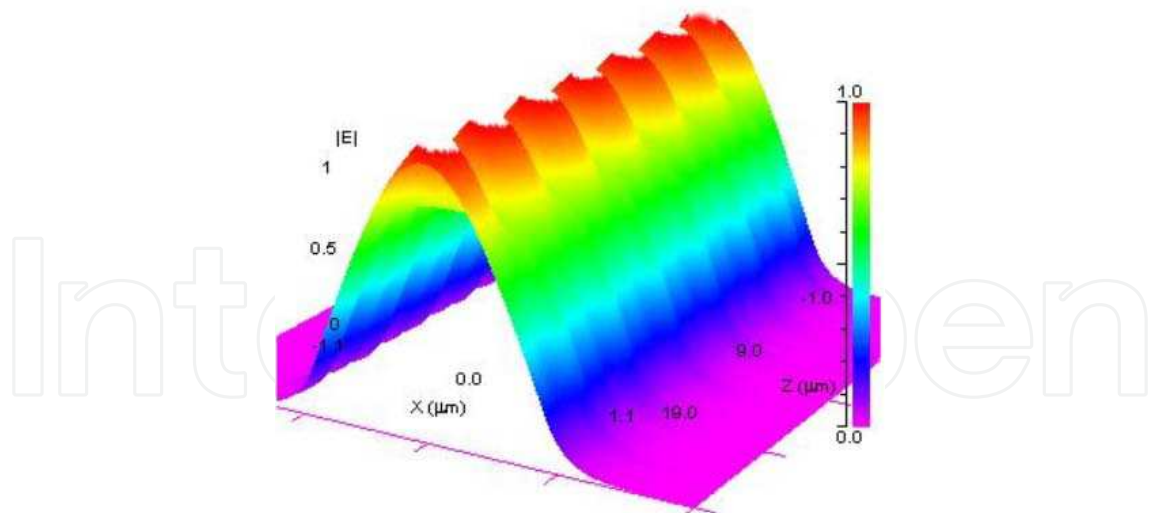

Fig. 10. Advanced optical simulation of the electrical field propagation in a $0.6 \mu\text{m}$ wide silicon nitride layer embedded in SiO_2 in CMOS integrated circuitry. Multimode optical propagation at 750 nm is demonstrated over $20 \mu\text{m}$ with a loss of less than 1 dB cm^{-1} .

Single mode propagation, where the light is more difficult to couple into the waveguide, results in low modal dispersion loss along the waveguide, as well as in extreme high modulation bandwidths.

It is important to note that waveguide mode converters can be designed to convert multimode into single mode.

In Fig 12 (b), the same simulation was performed as in Fig. 11, but with a silicon oxo-nitride core of $0.2 \mu\text{m}$ embedded in a silicon oxide cladding. The mode field plot shows a slight increase in the fundamental mode field diameter, and less loss of about 0.35 dB cm^{-1} . This suggests that a larger proportion of the optical radiation is propagating in the silicon oxide cladding.

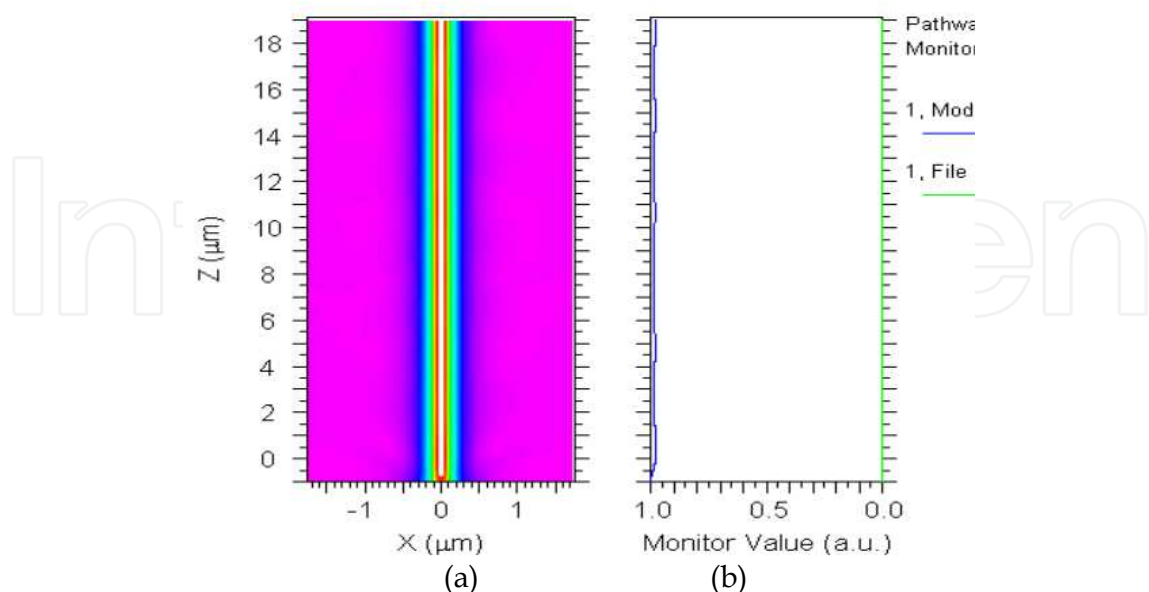

Fig. 11. (a) and (b): Advanced simulation of the electrical field propagation in a silicon nitride layer within CMOS integrated circuitry. Single mode propagation is demonstrated at 750 nm over a distance of $20 \mu\text{m}$ for a $0.2 \mu\text{m}$ wide silicon nitride waveguide, embedded in SiO_2 .

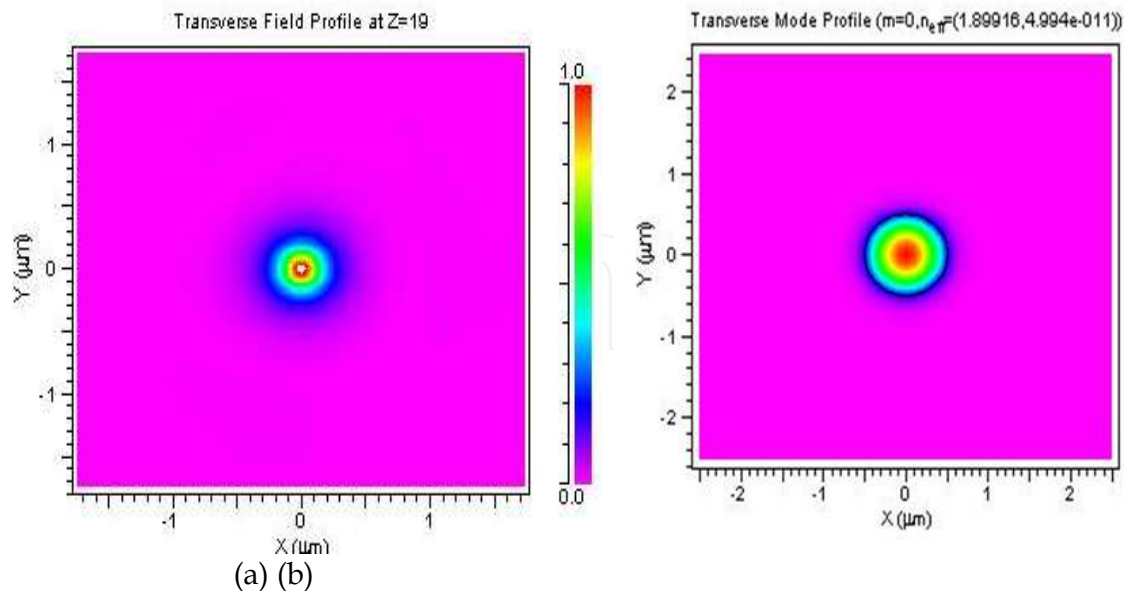

Fig. 12. (a) Transverse field profile prediction for a silicon nitride based CMOS waveguide. The core of the silicon nitride is $0.2 \mu\text{m}$ in diameter and is embedded in a $1 \mu\text{m}$ diameter SiO_2 cladding. (b) Transverse mode field profile for a $0.3 \mu\text{m}$ oxo-nitride layer embedded in SiO_2 .

Subsequently, a modal dispersion analysis was conducted on these structures. The calculations reveal a maximum dispersion of 0.5 ps cm^{-1} and a bandwidth-length product of greater than 100 GHz-cm for a $0.2 \mu\text{m}$ silicon nitride based core. A maximum modal dispersion of 0.2 ps cm^{-1} and a bandwidth-length product of greater than 200 GHz-cm was found for a $0.2 \mu\text{m}$ silicon-oxo-nitride core which was embedded in a $1 \mu\text{m}$ diameter silicon-oxide cladding. Due to the lower refractive index difference between the core and the cladding, a larger transverse electric field of about $0.5 \mu\text{m}$ radius, as well as lower modal dispersion, is achieved with a silicon oxo-nitride core. The material dispersion characteristic was estimated at approximately $10^{-3} \text{ ps nm}^{-1} \text{ cm}^{-1}$, which is much lower than the maximum predicted modal dispersion for the designed waveguides.

5. CMOS optical link - proof of concept

The photo-micrographs in Fig. 13 illustrate results which have been achieved with a CMOS opto-coupler arrangement, containing a CMOS Av-based light-emitting source, an $5 \times 1 \times 150 \mu\text{m}$ silicon over-layer waveguide and a lateral incident optimized CMOS based photo-detector (Snyman & Canning 2002, Snyman et al, 2004). The waveguide was fabricated in CMOS similar to that as shown in Fig. 5 (b).

Fig. 13 (a) shows an optical microscope picture of the structure under normal illumination conditions with the Si LED source, the waveguide and the elongated diode detector. Fig. 13 (b) shows the structure as it appeared under subdued lighting conditions. At the end of the silicon oxide structure, some leakage of the transmitted light was observed (feature B). This observation is quite similar to light emission observed at the end of a standard optical fibre, and it confirms that good light transmission occurs along the waveguide.

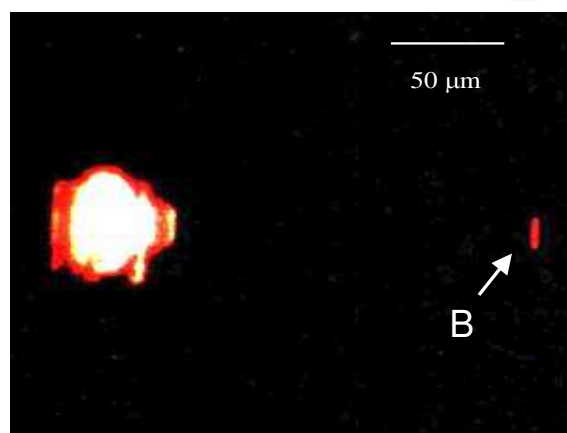
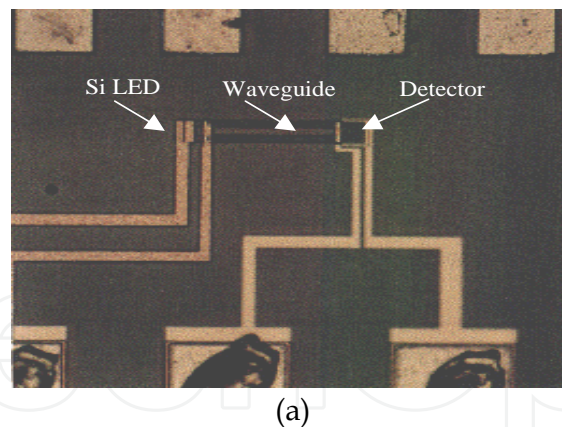

Fig. 13. Photomicrographs of a CMOS opto-coupler arrangement consisting of a CMOS Av-based light-emitting source, an optically waveguide and a CMOS lateral incident photo-detector. (a) shows a bright field photo-micrograph of the arrangement, and (b) shows the optical performance as observed under dark field conditions (Snyman et al, 2000, 2004).

Signals of 60 – 100 nA could be observed for 0 to +20 V source pulses and +10 V bias at the elongated diode detector. When the detector was replaced with a n⁺pn photo-transistor detector (providing some internal gain at the detector at appropriate voltage biasing), signals of up to 1 μA could be detected.

The arrangement showed good electrical isolation of larger than 100 MΩ between the Si LED and the detector for voltage variations between the source and the detector of 0 to +10V on either side when no optical coupling structures were present. This was mainly due to the p⁺n and n⁺p reversed biased opposing structures utilised in the silicon design. Once an avalanching light emitting mode was achieved at the source side, a clear corresponding current response was observed at the detector. Detailed test structures are currently investigated.

6. Proposed CMOS and SOI waveguide-based optical link technology

Building on the optical source and waveguide concepts, as outlined in the preceding sections, optical source based systems may be designed which optimally couple light into the core of an adjacently positioned optical waveguide. Similarly, the core of the waveguide can laterally couple light into an adjacent RAPD based photo diode. It follows that

interesting high speed source- detector optical communication channels and systems can be implanted in CMOS technology as illustrated in Fig. 14 (Snyman , 2010d, 2011a). The proposed isolation trench waveguide technology as outlined in Section. 2 is particularly well suited in order to create such configurations in CMOS technology. However, OLED surface layer structures together with CMOS technology and Si Av LED and SOI technologies may also generate such structures.

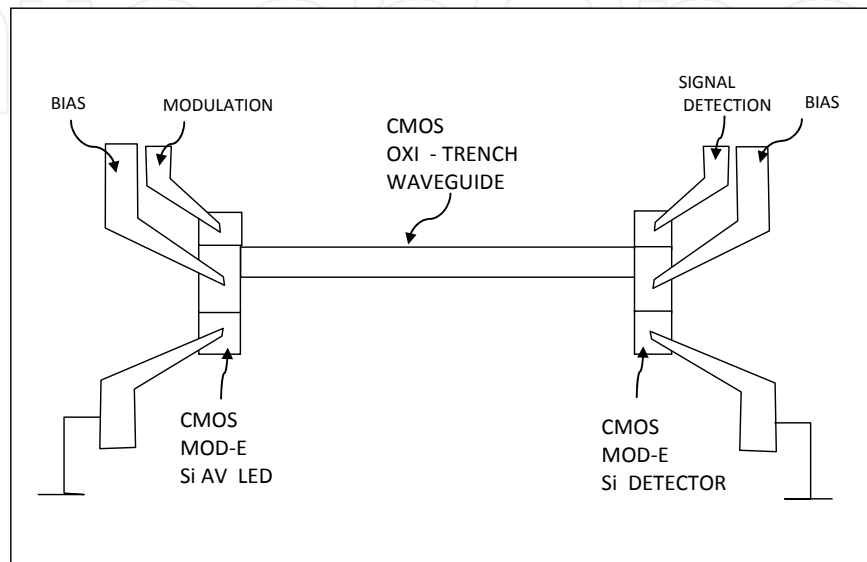

Fig. 14. Conceptual optical link design using a optical source arrangement as in Fig . 8 , a CMOS trench based waveguide and a RAPD photo detector arrangement. Bi-directional optical communication may be realised with the structure.

Using a Si Av LED optical source, an optical p+nnpn source, as outlined in Fig. 8 can be designed, with its optical emission point aligned with a lateral propagating CMOS based waveguide. Similarly, lateral incident detectors can be designed that take advantage of the carrier multiplication and high drift concept of reach through avalanche based diodes (RAPD). This can be combined with the proposed CMOS trench- waveguide systems. This implies that a similar lateral n+pp-p+ structure could be designed, such that with suitable voltage biasing, a high carrier generation adjacent to a high carrier drift region is formed. By placing an appropriate contact probe in the high drift region, varying voltage signals could be detected as a function of drift current. Silicon detector technology has been quite well established during the last few decades. These devices enerate up to 0.6 A W^{-1} and reach up to 20 GHz (Senior, 2008).

The generic nature of these designs open up numerous and diverse types of optical communication and optical signal processing devices realized in CMOS technology. Transmitter-receiver arrangements can be designed that will enable full bi-directional optical communication. The concepts, outlined here are not final , and there is scope for further improvement.

A drawback of these designs is the fact that the optical source needs to be driven by direct modulation methods. OLEDs have the advantage of low modulation current or voltage. However, they may be limited by forward biased diffusion capacitance effects. Si Av LEDs require low modulation voltage, but high driving currents. Since the driving current needs

to be supplied by CMOS driver circuitry, this implies large area CMOS driving PMOS and NMOS transistors with high capacitance. Through the incorporation of localized hybrid technologies, appropriate waveguide based modulators can be designed, that are either based on the electro-optic (Kerr) effect or the charge injection effect. It is envisaged to reach modulation speeds, orders of magnitude higher (reaching far into the GHz range), with much less driving currents (Snyman, 2010d).

7. Optical coupling efficiencies and optical link power budgets

Obtaining good coupling efficiencies with Si Av LEDs and OLEDs when incorporated into CMOS structures presents a major challenge. It is estimated that the optical power emitted from the Si Av LEDs is in the order of 100 – 1000 nW (for typical driving powers of 8 V and 10 μ A). Since most of the emission occurs inside the silicon with a refractive index of 3.5, it implies that only about 1 % of this optical power can leave the silicon because of the small critical angle of only 17 degrees inside the silicon. After leaving the silicon the light spreads over an angle of 180 degrees (Fig.15 (a)). When a standard multimode optical fibre with a numerical aperture of 0.3 is placed close to such an emission point, only 0.3 % of the forward emitted optical power enters the fibre.

Our research has shown that remarkable increases in optical coupling efficiencies can be achieved by means of two techniques: (1) concentrating the current that generates the light as close as possible to the surface of the silicon (for Si Av LEDs); and, (2), maximizing the solid angle of emission in the secondary waveguide.

By displacing the metal contacts that provide current to the structure as shown in Fig 15 (b), the current is enforced on the one side surface facing the core of the waveguide. Since mainly surface emission is generated, about 50 % of the generated optical power enters the waveguide (Snyman 2010d, Snyman 2011 a). A silicon nitride core with a silicon oxide cladding could then ensure an acceptance angle of up to 52.2 degrees within the waveguide. The total coupling efficiency that can be achieved with such an arrangement is of the order of 30%. This is an 100 fold increase in coupling efficiency from the point of generation to within the waveguide as achieved in Fig 15 (a) (Snyman, 2011c).

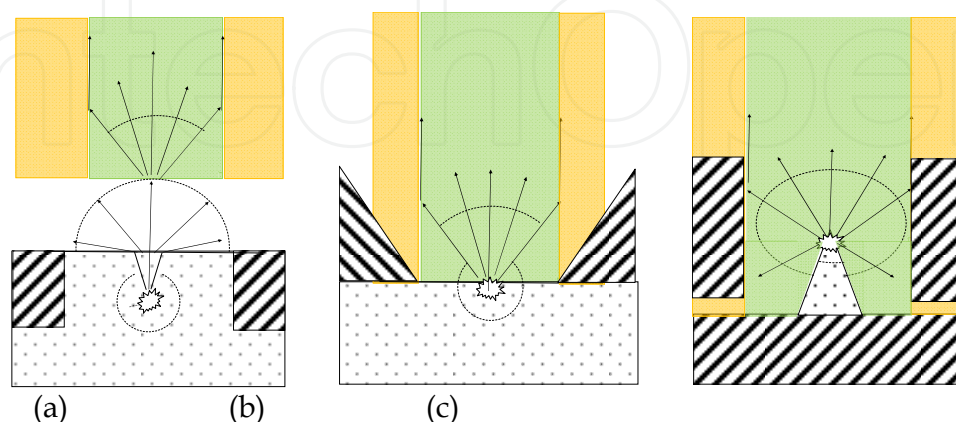

Fig. 15. Demonstration of optical coupling between a Si Av LED optical source and the silicon nitride CMOS based optical waveguide.

Fig. 15 (c) shows a further optimized design. Here a thin protrusion of doped silicon material is placed inside the core of a silicon nitride core CMOS based waveguide (Snyman 2011a). Such a design is quite feasible with standard layout techniques of CMOS silicon provided that the side trenches surrounding the silicon protrusion are effectively filled with silicon nitride through the plasma deposition process. The core is surrounded by trenches of silicon oxide. The optical power that is generated at the tip of the protrusion and radiates in a solid angle of close to a full sphere inside the waveguide. Simulation studies show that up to 80 % of the emitted light is now coupled into the silicon nitride core. Reflective metal surfaces at the sides and the back of this waveguide may further improve the forward propagation.

The optical radiation produced inside these waveguides will be highly multimode. The diameters of these waveguides may be bigger than the ones suggested for single mode propagation in Section 4. However, in such cases, standard type waveguide mode converters can reduce the number of modes or even generate single mode propagation.

With an optical power source of 1 μW at the silicon surface, one can achieve a coupling efficiency between source and waveguide of 30 to 50 %, assuming a coupling loss of only 3 dB between source and waveguide. With a 0.6 dB cm^{-1} wave guide loss, the loss in the 100 μm waveguide itself is estimated to be 0.01 dB. Since the whole radiation propagating in the waveguide can be delivered with almost 100 % coupling efficiency, one can expect about 500 nW of optical power reaching the detector. With an 0.3 A per Watt conversion efficiency of the detector, current levels of about 100 nA (0.1 μA) can be sensed with a 10 \times 10 μm detector. Values for OLEDs together with surface CMOS waveguides could be much higher. The low frequency detection limit of silicon detectors of such dimensions is of the order of pico-Watt. For low frequencies and low optical level detection, a dynamic range of about 10^3 to 10^4 is achievable. At high modulation speeds, the achievable bit error rates will obviously increase.

The optical powers quoted above are much lower when compared with current LASER, LED and optical fiber link "macro" technology. However, we are addressing a new field of "micro-photonics" with micrometer and nano-meter dimensions, and power levels as well as other parameters should be scaled down accordingly. Furthermore, our research showed that the optical intensities determine the achievable bit error rates rather than absolute intensities. As stated earlier, the calculated intensity levels with some of our Si Av LEDs are as high as 1 nW μm^{-2} .

8. Connecting with the environment

We present only two viable ways of communicating with the outside chip environment:, i.e optical communication vertically outward from the chip, and optical communication via lateral waveguide connections.

In the first case, silicon oxide and silicon nitride are used as well as trench technology as outlined in Section 2 in order to increase the vertical outward radial emission (Snyman, 2011c). Fig. 16 illustrates the concept. By placing a thin layer of silicon adjacent to two semi-circular trenches, the solid angle of the optical outward emission is increased within the silicon from about 17 to almost 60 degrees. Filling up the trenches with silicon oxide and placing of thin layer of silicon oxide increases the critical emission angle from the silicon from 17 to 37 degrees. The thin layer of silicon nitride can be appropriately shaped with post processing RF etching techniques such that all emitted light can be directed vertically

upward. It is estimated that a total optical coupling efficiency from silicon to fibre of up to 40 % can be achieved in this way.

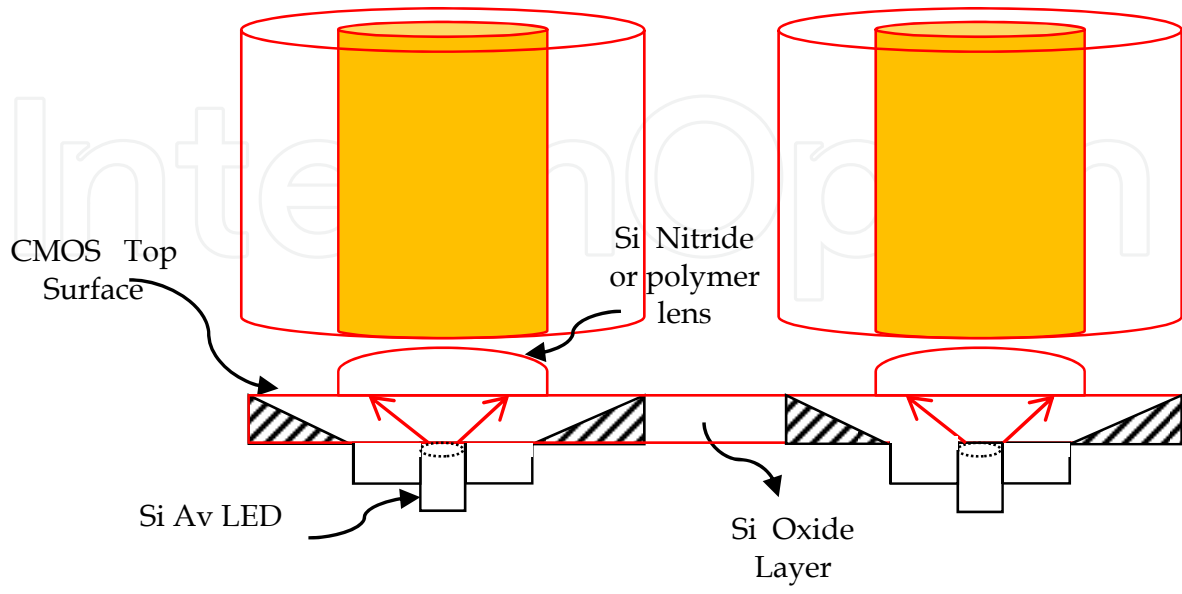

Fig. 16. Vertical outward coupling of optical radiation into optical fiber waveguides using trench based and overlayer post processing technology.

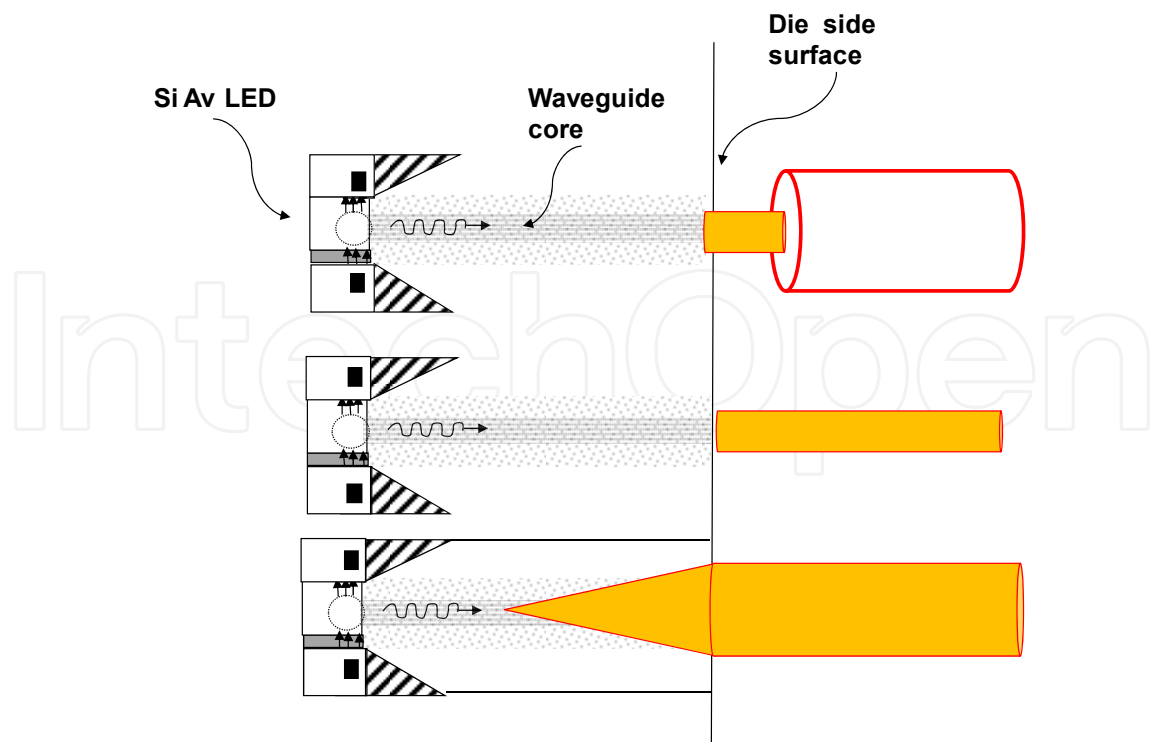

Fig. 17. Lateral out coupling using CMOS waveguide based optical coupling with optical fibers aligned at the side surface of the chip.

In the second case, optical coupling is achieved via lateral wave guiding (Snyman, 2010 d, 2011 c, 2011d). Fig. 17 illustrates this. (1) The lateral coupling from the optical source can be as high as 80 % as demonstrated in the previous section in Fig. 15 (c). (2) The optical radiation can be converted from multi-mode propagation to single mode propagation by waveguide mode converters; (3) Single mode radiation at the side surface ensures high collimation. This assures a coupling efficiency of almost 100 % at the side surface. In total, an optical coupling efficiency of up to 80 % can be achieved. This is much higher than achievable with vertical coupling. (4) Our analysis shows that the far field pattern of the optical radiation emitted from the waveguides can be manipulated by either adiabatic expansion or by tapering the core near the end of the waveguide. In this way the mode field diameter extends into the silicon oxide cladding, and the radiation couples more efficiently into the core from an externally positioned optical fibre.

In conclusion, the analysis shows that combining CMOS compatible sources effectively with on-chip lateral extending waveguide technology, offers major advantages, like increased coupling efficiencies, increased optical power link budgets, lower achievable bit error rates in data communication, and better coupling with the external environment.

9. Proposed first iteration CMOS micro-photonic systems

The on-chip optical and signal processing applications have been already highlighted in Section 6. A particular interesting design, made possible with the CMOS waveguide technology, is a so called H-configuration waveguide that can be used for optical clocks in very large CMOS micro-processor systems (Wada, 2004).

The realization of diverse other CMOS and waveguide based micro-photonic systems as well as the incorporation of a whole range of micro-sensors into CMOS technology is possible. The advantages are, (1), high levels of miniaturization; (2), higher reliability levels; (3), a vast reduction in technology complexity and, (4), a drastic reduction in production costs. The proposed waveguide technologies, particularly in this chapter, offer high optical coupling between Si Av LEDs or OLEDs and CMOS based waveguides, with diverse applications in optical interconnect and future on chip micro-photonic systems.

Fig. 18 to 20 illustrate some applications, as proposed here, for CMOS based micro-photonic systems (Snyman 2008a, 2009a, 2010c, 2011b, 2011c).

In Fig. 18, a hybrid approach is demonstrated. A mechanical module is added to an existing CMOS package creating a CMOS-based micro-mechanical optical sensor (CMOS MOEMS), capable of detecting diverse physical parameters such as vibration, pressure, mechanical oscillation etc. Optical radiation is coupled from the CMOS platform to the mechanical platform. The mechanical platform returns optical signals which contain information about the deflection (Snyman, 2011 c).

Fig. 19 shows a monolithic approach of creating CMOS MOEMS involving only post-processing procedures. A cantilever is fabricated in part of the CMOS IC die, by post processing procedures. Si Av LED or OLEDs couple optical radiation into a slanted waveguide track, transmit the optical radiation laterally across the die, collimate the radiation through the crevasse onto the one side of the cantilever. Optical radiation is reflected from the cantilever and detected by a series of p-i-n photo-detectors arranged laterally along the crevasse side surface. The accumulated signals are processed by adjacent

CMOS analogue and digital processing circuits. Such a structure can detect vibrations, rotations and accelerations (Snyman, 2011 c).

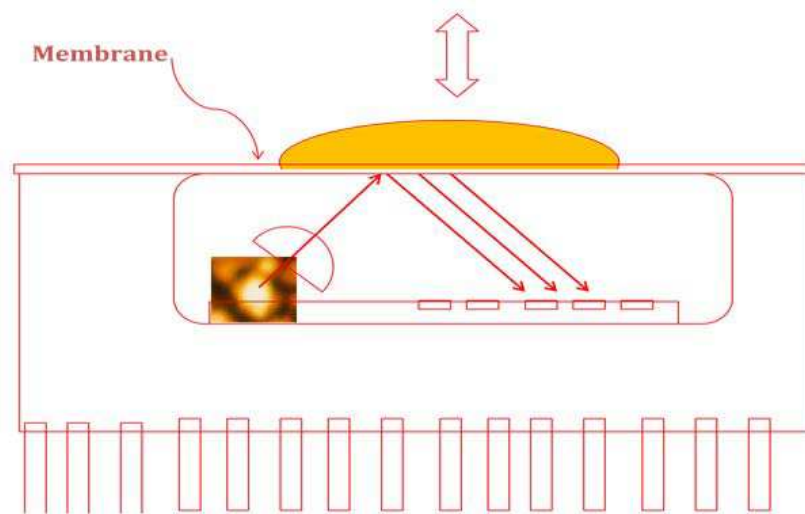

Fig. 18. Schematic diagram of a hybrid CMOS-based micro-photonic system that can be realized by placing a mechanical- module on top of a optically radiative and detector active CMOS platform using standard packaging technology.

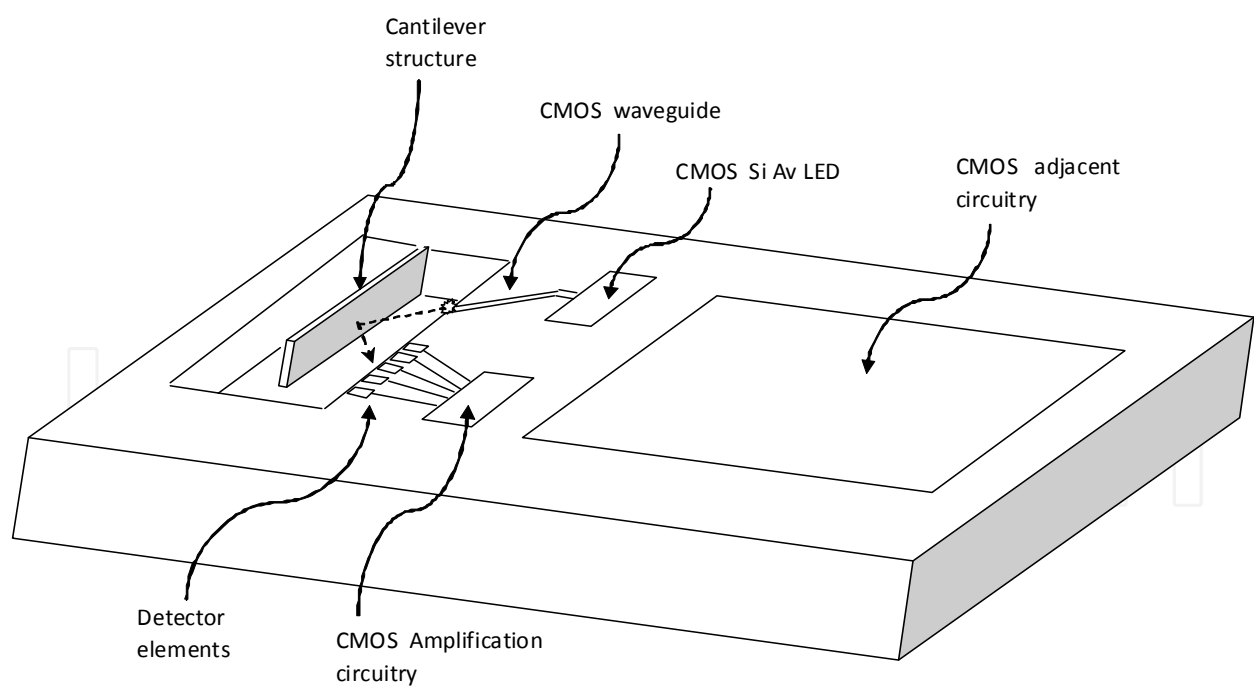

Fig. 19. Schematic diagram of an example CMOS-based Micro-Mechanical-Optical Sensor (MOEMS) device that can be realized with conventional CMOS integrated design with additional post processing procedures. Key constituents of such a device is an effective CMOS on-chip optical source , coupling of the source to a waveguide, CMOS compatible optical waveguiding and optical collimation and detection circuitry.

The immunity to electromagnetic induced noise of these systems is a major advantage. Key components of such the systems are an effective CMOS compatible optical source, CMOS compatible optical wave guiding, effective optical coupling into the waveguide, and optical collimation circuitry. The sensitivity and functionality of these systems are a function of the waveguide design.

Fig. 20 explores a more complete and more advanced waveguide based micro-photonic system design including ring resonators, filters and an unbalanced Mach-Zehnder interferometer. By selectively opening up a portion of the waveguide in the one arm of the interferometer to the environment, molecules or gases can be absorbed and both, phase and intensity changes can be detected by the interferometer. Sensors can be designed which detect the absorption spectra of liquids (Snyman 2008a, 2009a, 2010c, 2011b, 2011c,).

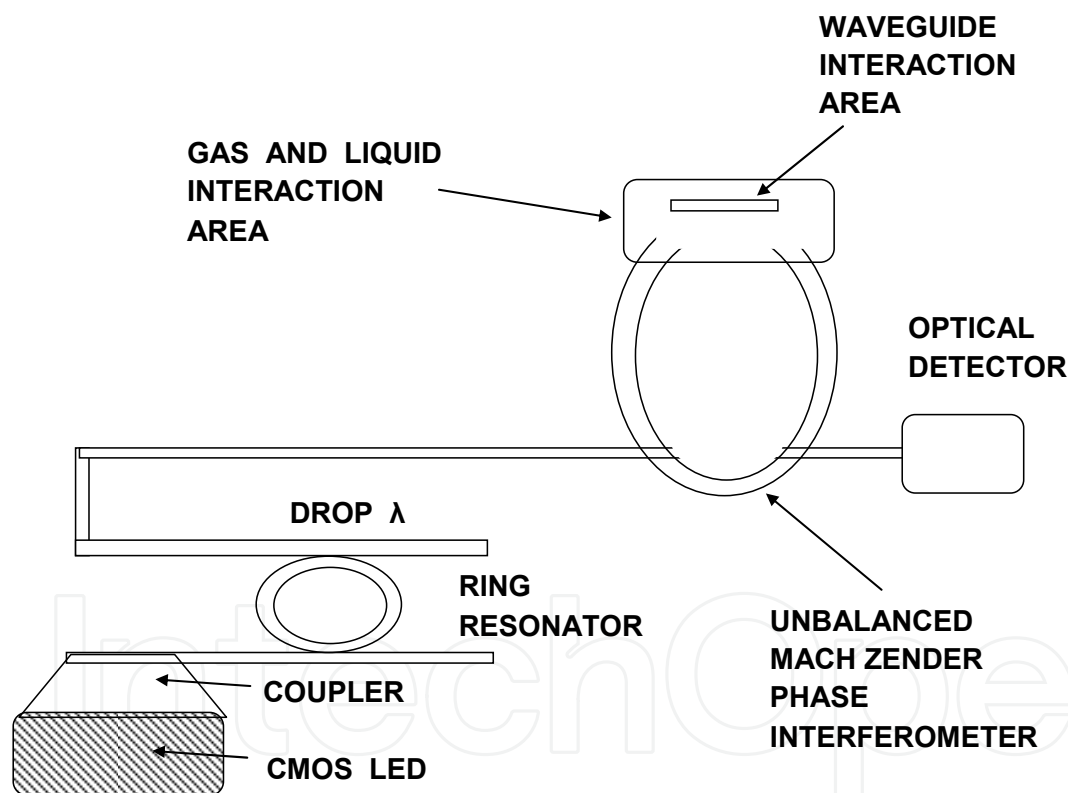

Fig. 20. Schematic diagram of a CMOS-based micro-photonic system that can be realized using an on chip Si Av LED, a series of waveguides, ring resonators and an unbalanced Mach-Zehnder interferometer. A section of the waveguide is exposed to the environment and can detect phase and intensity contrast due to absorption of molecules and gases in the evanescent field of the waveguide.

Obviously, a great variety of diverse other types of CMOS based micro-photonics systems are possible, each incorporating specific optical micro-sensors and waveguides. It is anticipated to implement future CMOS based micro-photonics systems in micro-spectro-photometry, micro-metrology, and micro-chemical absorption analysis.

10. Conclusions

It is evident that the analyses as presented in this study with regard to Si Light Emitting Devices operating at 650 – 850 nm and lateral optical waveguides can lead to the generation of diverse photonic micro-systems systems in standard CMOS integrated circuitry. The generation of lateral waveguides in CMOS technology operating in this wavelength regime poses particular challenges. However, enough evidence has been obtained from our analyses and first iteration experimental realisations that this technology is indeed feasible. The proposed sub-technologies has major advantageous for the generation of complete new families of photonic micro-systems on CMOS chip avoiding the more complex Si Ge or III-V hybrid technology. The following serves as brief summaries of results and statements made:

1. The potential of CMOS technology was analysed and evaluated for sustaining the generation of optical micro-photonics systems in CMOS integrated circuitry. Particularly, the silicon dioxide “field “ oxide , inter-metallic oxides and passivation nitride and added polymer over-layer structures show good potential to be utilised as “building blocks” in new generation CMOS based micro-photonics systems.
2. It was shown that a variety of optical source technologies currently already exists that can be utilised for the generation of 650- 850nm optical sources on chip. OLEDs offers high irradiance in this wavelength regime. There are however challenges with regard to incorporation of the hybrid organic based technologies into CMOS technology and with regard to achieving high modulation speeds. Silicon avalanche-based Si LEDs can be integrated into CMOS integrated circuitry with relative ease, they offer high modulation bandwidth , and can be integrated particularly at the silicon-overlayer interface, and offer both vertical and lateral optical coupling possibilities. Their power conversion efficiency is lower, but analysis show that the power levels is enough to offer adequate power link budgets , with high modulation bandwidth. Particularly, they can generated micron size optical emission points, with high irradiance levels, offering unique application possibilities with regard to generating of micro-structured photonic devices.
3. Analyses and simulation results as presented in this study, show that it is possible to design waveguides with CMOS technology at 650-850 nm. Particularly, the generation of waveguides with small dimension silicon nitride cores embedded in larger silicon dioxide surrounds seems particularly attractive. The utilisation of lateral CMOS waveguides increase coupling efficiencies, improve optical link power budgets, and supports numerous designs with regard to the generation of micro-photonics structures in CMOS integrated circuitry. These aspects are all beneficial for generating lateral layouts of micro-photonics systems on chip and offers viable options for interfacing optically with the environment..
4. The technology as proposed, may not necessarily compete with the ultra high modulation speeds offered by Si-Ge based and SOI based technologies currently

operating at above 1100nm. However, Si Av LEDs, waveguides detectors, demonstrated in this study, support the generation of micro-photonic systems in standard CMOS technology, offering modulation speeds of up to 10 GHz at the added advantage of ease of integration into standard integrated circuit technology. Direct driving of the sources in CMOS may reduce modulation speeds. Particularly, the use of waveguide-based modulators may produce higher modulation speeds (Snyman 2010e). Several advances in this area could still be made.

5. Lastly, a few designs are proposed for the realisation of first iteration micro-photonic sensor systems on chip. Both mechanically as well as adhesion and waveguide based sensors systems are proposed and the application possibilities of each were presented. Particularly, the proposed technologies offers the realisation of a complete new family of source-sensor based micro-photonic systems where bandwidth is not the essential parameter, but rather the capability to add to the integration level, intelligence level, and the interfacing level of the processing circuitry with the environment.

11. Acknowledgements

The hypotheses, analyses, first iteration results and research interpretations as presented in this study were generated by means of South African National Research Foundation grants FA200604110043 (2007-2009) and NRF KISC grant 69798 (2009-2011) and SANRF travel block grants (2007,2008, 2009). The utilization of facilities at the Carl and Emily Fuchs Institute for Microelectronics for confirmation of some of the experimental results is gratefully acknowledged. The provision and use of advanced software facilities at the TUT is acknowledged. The final proof reading of the script by Dr. D. Schmieder is especially acknowledged.

Selected topics of this article forms the subject of recent PCT Patent Application PCT/ZA2010/00032 of 2010, (Priority patents: ZA2010/00200, ZA2009/09015, ZA2009/08833, ZA2009/04508) ; PCT Patent Application PCT/ZA2010/00033 of 2010 (Priority patents: ZA 2008/1089, ZA2009/04509, ZA2009/04665, ZA2009/04666, ZA2009/05249, ZA2009/08834, ZA2009/0915), ZA2010/08579, ZA2011/03826; and PCT Patent Application PCT/ZA2010/00031 of 2010" (Priority patents: ZA 2010/02021, ZA 2010/00201, ZA2010/00200, ZA 2009/07233, ZA2009/07418, ZA 2009/04164, ZA200904163, ZA2009/04161). These all deal with our latest technology definitions with regard to OLED and Si Av LED CMOS based optical communication systems, Si Av LED design, CMOS waveguide design, CMOS modulator and switch design, CMOS based data transfer systems, CMOS micro-photonic system and Micro-Optical Mechanical Sensors (MOEMS) design. The purpose of these patents is to secure intellectual property protection on investments made already, and to secure licensing of certain key components of the technology as already developed. However, the opportunities in this field is so extensive, that numerous further investment opportunities with interested further investors exist.

12. References

- Aharoni, H. & Du Plessis, M., "The Spatial Distribution of Light from Silicon LED's", *Sensors and Actuators*, Vol. A 57 No. 3, (1996), pp. 233-237.

- Beals, M., Micheal, J., Liu, F.J, Ahn, D.H, Sparacin, D. , Sun, R., Hong, C.Y. & Kimerling, L.C., (2008) , "Process flow innovations for photonic device integration in CMOS", *Proceedings of SPIE 6898*, pp. 6898 O4 – O14.
- Bourouina, T. , Bosseboeuf, A. & Grandchamp, J-P, (1996) . "Design and Simulation of an Electrostatic Micro-pump for Drug-Delivery Applications". *MicroMechanics Europe Workshop (MME'96)*, pp 152-155, Barcelone .
- Brummer, J. C., Aharoni, H. ,& du Plessis, M. , "Visible Light from Guardring Avalanche Silicon Photodiodes at Different Current Levels", *South African Journal of Physics* Vol. 16 (1/2),(1993), pp 149-152.
- Bude, J., Sano, & N., Yoshii, A. , "Hot carrier Luminescence in Silicon", *Physical Review* Vol. B 45, No. 11, (1992), pp. 5848 – 5856.
- Carbone, L. , Brunetti, R., Jacoboni, C. , Lacaita, A. & Fischetti, M. , "Polarization analysis of hot-carrier emission in silicon, " *Semicond.Sci. Technol.* Vol. 9, (1994), pp. 647-676.
- Chatterjee, B., Bhuva & Schrimpf, R., "High-speed light modulation in avalanche breakdown mode for Si diodes", *IEEE Electron Device Letters* , Vol. 25, No. 9,(2004), pp. 628-630.
- Claeys, C., (Fellow, IEEE), (2009). "Trends and Challenges in More Moore and More than Moore Research", *Proceedings of the South African Conference on Semiconductors and Superconductors (SACSST)*, pp 1-6 , ISBN 978-0-620-43865-0, Cape Town, South Africa.
- Daldosso,N., Melchiorri, M., Riboli, F., Sbrana, F., Pavesi, L., Pucker,G., Kompocholis, C., Crivellari,M., Belluti, P., & Lui, A., "Fabrication and optical characterization of thin two-dimensional Si₃N₄ waveguides" *Mater. Sci. Semicond. Process.* Vol. 7, (2004), pp. 453-458.
- Du Plessis, M. , Aharoni, H. & Snyman, L.W., "A silicon trans-conductance light emitting device (TRANSLED)." , *Sensors and Actuators* , Vol. A 80, No. 3, (2003), pp 242-248.
- Du Plessis, M., Aharoni, H. , & Snyman, L.W., " Spatial and intensity modulation of light emission from a silicon LED matrix", *IEEE Photonics Technology Letters* , Vol. 14, No. 6, (2002), pp. 768-770.
- Du Plessis, M., Snyman, L.W. , & Aharoni, H. (2003). " Low-Voltage Light Emitting Devices in Silicon IC Technology", *Proc. of the IEEE International Symposium on Industrial Electronics (ISIE 2005)*, Vol. 3 , ISBN 0-7803-8739-2 , pp. 1145- 1149, Dubrovnik, Croatia.
- Fauchet, P. M., "Progress Toward Nano-scale Silicon Light Emitters", *IEEE Jour. Selected Topics in Quantum Electron* Vol.4, (1998) , pp. 1020-1028.
- Fitzgerald, E.A. ,& Kimerling, L.C. , "Silicon-Based Technology for Integrated Optoelectronics", *MRS Bulletin*, (1998), pp. 39-47.
- Foty, D., "Digital CMOS Electronics", Gilgamesh Associates, LLC, Fletcher, Vermont, USA. (2009). Private communication .
- Fullin, E., Voirin,E., Lagos, A., Moret, J.M., "MOS-Based Technology for Integrated Optoelectronic Circuits", *Scientific and technical report, CSEM*, (1993), pp. 26.

- Ghynoweth, W.G. & McKay, K.G. , "Photon emission from avalanche breakdown in silicon", *Physical Rev.* Vol. 102 , (1956), pp. 369-376.
- Gianchandani , Y. B. , (Fellow, IEEE), (2010) " Emerging Research in Micro and Nano Systems: Opportunities and Challenges for Societal Impact" , In: *Microfluidics, BioMEMS, and Medical Microsystems VIII*, edited by Holger Becker and Wanjun Wang, Proc. of SPIE, available at doi: 10.1117/12.848216 (Plenary lecture).
- Gorin, A., Jaouad, A., Grondin, E., Aimez, V. & Charette, P. , " Fabrication of silicon nitride waveguides for visible-light using PECVD: a study of the effect of plasma frequency on optical properties". *Optics Express*, Vol. 116, No. 18, (2008), pp 13509-13516.
- Green, M.A., Zhao, J., Wang, A. , Reece, P. & Gal , M., "Efficient silicon light-emitting diodes" *Nature* , Vol. 412, (2001), pp 805-808.
- Gunn ,G., Narasimha, A., Analui, B. , Liang, Y. & Sleboda, T.J. (2007) "A 40Gbps CMOS Photonics Transceiver",. In: *Silicon Photonics II* , Proc SPIE , Vol. 6477, (ISBN 9780819465900), pp. 64770N1- 8.
- Hirschman, K. D., Tsybeskov, L., Duttagupta, S. P. & Fauchet, P. M. , "Silicon-based visible light-emitting devices integrated into microelectronic circuits," *Nature*, Vol. 384, (1996), pp. 338-341.
- Kramer, J. , Seitz, P. , Steigmeier, E. F. , Auderset, H., and Delley, B., "Industrial CMOS technology for the integration of optical metrology systems," *Sensors and Actuators A* Vol. A37-38,(1993), pp. 527-533.
- Kubby, J. A . & Reed, G. (2007). Introductory remarks, In: *Silicon Photonics II* , Proc. SPIE, Vol. 6477. (ISBN 9780819465900), pp. xi.
- Kubby, J. A.& Reed, G. (2010). Introductory remarks. In: *Silicon Photonics V* , Proc SPIE Vol. 6477, ISBN 9780819480026, pp xi.
- Lacaita, K., Zappa, F, Bigliardi, S. & Manfredi, M. , "On the Brehmstrahlung origin of hot-carrier-induced photons in silicon devices", *IEEE Trans. Electron Devices*, Vol. ED40, (1993), pp. 577-582.
- Liu, J., Sun, X. , Rodolfo Camacho-Aguilera, R., Kimerling, L.C. and Michel, J. , " Ge-on-Si Laser operating at room temperature" *Optics Letters* Vol. 35, No. 5, (2010), pp. 679-681.
- Newman, R. , "Visible light emission from a silicon p-n junction", *Phys. Rev.* Vol. 100, (1955), pp. 700 - 703.
- Ogudo, K. A. , Snyman , L.W. , Du Plessis, M. & Udahemuka, G. (2009). "Simulation of Si LED (450nm-750nm) light propagation phenomena in CMOS integrated circuitry for MOEMS applications" , *Proceedings of the South Africa Conference on Semiconductor and Superconducting Technologies (SACSST 2009)* , ISBN 978-0-620-43865-0, pp. 168-182.
- Robbins, D.J. , Editorial comments . (2000). "Silicon Opto-electronics" , *Proc. of SPIE*, Vol. 3953, pp. vi, San Jose, California, USA.
- Savage, N., "Linking with Light", *IEEE Spectrum*, Vol. 39, (2002), pp. 32-36.
- Schneider, K., and Zimmerman, H. , In: *Highly sensitive optical receivers* , (2006) , Springer, ISBN 13978-3-546-29613-3.

- Sedra , A.S. & Smith, K.C. (2004). "VLSI Fabrication Technology" In: *Microelectronics Circuits*, Oxford University Press, New York, ISBN 13:978-0-19-514252-5, pp. A 12.
- Senior, J. M. , "Optical Detectors", In: *Optical Fiber Communications, Principles and Practice*, (3rd Edition), (2008). Prentice Hall. pp 444..
- Snyman , L. W. , Ogudo , K.A. , Du Plessis M. & Udahemuka , G. , (2009). "Application of Si LED's (450nm-750nm) in CMOS integrated circuitry based MOEMS - Simulation and Analyses", *Proc. SPIE*, Vol. 7208, pp. 72080C (ISSN 0277-786X) Available at <http://dx.doi.org/10.1117/12.808551>.
- Snyman L. W. "Hybrid and monolithic Microsystems and MOEMS", (2011). RSA Patent application 2011/03826 of 25th May 2011.
- Snyman L. W., "CMOS LED MOEMS Devices", (2008), RSA Patent Appl. No. 2008/1089, of 1 February 2008 .
- Snyman, L . W. , Du Plessis, M.,& Aharoni, H . , (2005). "Three terminal optical sources (450nm - 750nm) for next-generation silicon CMOS OEIC's" , *12th International Conference of Mixed Design of Integrated Circuits and Systems (MIXDES'2005)*, pp. 737 - 747. Krakov, Poland (Invited plenary session paper).
- Snyman, L. W. , & Du Plessis, M. (2008). "Increasing The emission intensity of p+np+ CMOS LED's (450 - 750 nm) by means of depletion layer profiling and reach-through techniques" ; In: *Silicon Photonics III* , Edited by Joel A Kubby and Graham T. Reed, *Proc. SPIE* , Vol. 6898 , pp. OE 1- 12, ISSN: 0277-786X, ISBN 9780819470737SPIE, Bellingham, W.A.
- Snyman, L. W. , Aharoni, H. and Du Plessis, M, "Two order increase in the quantum efficiency of silicon CMOS n+pn avalanche-based light emitting devices as a function of current density" *IEEE Photonic Technology Letters*, Vol. 17, (2005), pp. 2041-2043.
- Snyman, L. W. , du Plessis, M. & Aharoni, H. (2006). "Two order increase in the optical emission intensity of CMOS integrated circuit LED's (450 - 750 nm). Comparison of n+pn and p+np designs " , *Proc of the SPIE* , Vol. 5730, pp. 59-72.
- Snyman, L. W. , Du Plessis, M. & Aharoni, H. , "Injection-avalanche based n+pn Si CMOS LED's (450nm . 750nm) with two order increase in light emission intensity - Applications for next generation silicon-based optoelectronics", *Jpn. J. Appl. Physics* Vol. 46 No. 4B, (2007), pp. 2474-2480.
- Snyman, L. W. "CMOS waveguide based transceiver " , (2010). RSA Patent Application 2010 /06804 of 23 September 2010.
- Snyman, L. W. "OLED and CMOS based micro-photonic systems", (2010). RSA Patent Application 2010 /08579 of 30 November 2010.
- Snyman, L. W., du Plessis, M., & Bellotti, E. , "Increasing the emission intensity of p+np+ CMOS LED's (450 - 750 nm) by means of depletion layer profiling and defect engineering techniques", *IEEE Journal of Quantum Electronics* , Vol. 46 , No. 6, (2010), pp. 906-919.
- Snyman, L. W., Ogudo, K. D. and Foty, D. (2011). "Development of a 0.75 micron wavelength CMOS optical communication system " , *Proc SPIE Vol 7943*, edited by

- Joel A. Kubby, Graham T. Reed, CCC code: 0277-786X/11/\$18 doi: 10.1117/12.873202, pp 79430K-1 to 12.
- Snyman, L. W., T. Okhai, T. Bourouina and W. Noell, (2011) "Development of on-CMOS chip Micro-Photonic and MOEMS Systems " Proc SPIE Vol 7930. MOEMS and Miniaturized Systems X, edited by Harald Schenk, Wibool Piyawattanametha, CCC code: 0277-786X/11/\$18 ·doi: 10.1117/12.873353, pp 79300Z-1 to 11.
- Snyman, L.W. (2010d)., "Optical communication system". PCT Patent Application PCT/ZA2010/00032.
- Snyman, L.W. , Aharoni, H. , du Plessis, M. , & Gouws, R.B.J. , "Increased efficiency of silicon light emitting diodes in a standard 1.2 micron complementary metal oxide semiconductor technology", *Optical Engineering* , Vol. 37, (1998), pp. 2133 - 2141.
- Snyman, L.W. , Aharoni, H., du Plessis, M. , Marais, J.F.K , van Niekerk, D. & Biber, A., "Planar light emitting electro-optical interfaces in standard silicon complementary metal oxide semiconductor integrated circuitry", *Optical Engineering* , Vol. 41, (2002), pp 3230 - 3240.
- Snyman, L.W. , Auderset, H., Derendinger, M. , Patterson, B.D. , & Von Lanthen, A. , "Efficient electroluminescence from 2- and 3-junction silicon structures", In: *Annual Report 1996/Annex.111B* of the Paul Scherrer Institute, Switzerland, Vol. 28 , (1996).
- Snyman, L.W. , Bogalecki, A. , Canning, L. , Du Plessis, M., & Aharoni, H. (2002). "High frequency optical integrated circuit design and first iteration realization in standard silicon CMOS integrated circuitry" *Proc. of the 10th IEEE International Symposium on Electron Devices and Optoelectronic Applications (EDMO 2002)*, IEEE Cat No. 02TH8629, pp. 77-82, Manchester, United Kingdom.
- Snyman, L.W. , Du Plessis, M. & Aharoni, H. (2005), "Three Terminal n+ppn Silicon CMOS Light Emitting Devices (450nm - 750nm) with Three Order Increase in Quantum Efficiency", *Proc. of the IEEE International Symposium on Industrial Electronics (ISIE 2005)* , Vol. 3, pp. 1159 - 1169. (Special session paper).
- Snyman, L.W. , du Plessis, M., Seevinck, E. , & Aharoni, H. , "An efficient, low voltage, high frequency silicon CMOS light emitting device and electro-optical interface", *IEEE Electron Device Letters* , Vol. 20,(1999), pp. 614-617.
- Snyman, L.W. "MOEMS sensor device", (2010). *PCT Patent Application* PCT/ZA2010/00033.
- Snyman, L.W. "Wavelength Specific Si CMOS LEDs", (2010). *PCT Patent Application* PCT/ZA2010/00031 (Priority patents: ZA 2009/07233, ZA2009/07478, ZA2009/07233, ZA2010/00201, ZA2010/02021) .
- Snyman, L.W., & Biber, A. (1999) , "Enhanced light emission from a Si n+pn CMOS structure" , *Proceedings of the 1999 IEEE SoutheastCon*, ISBN 0-7803-5237-8, . pp. 242 - 245, Conference held at Lexington, Kentucky, U.S.A.,
- Snyman, L.W., "Increased coupling efficiencies with CMOS-based waveguides " , (2011). *RSA Patent* (submitted August 2011).
- Snyman, L.W., and Bellotti, E. , (2010). "New Interpretation of Photonic Yield Processes (450-750 nm) in Multi-junction Si CMOS LEDs : Simulation and Analyses " , in

- Silicon Photonics IV*, edited by Joel A Kubby, Graham T. Reed, Proceedings of SPIE Vol. 7606, ISBN 9780819480026, ISSN 0277-786X, pp. 760613-15, as available at doi: 10.1117/12.843134).
- Snyman, L.W., Canning, L.M., Bogalecki, A., Aharoni, H., & du Plessis, M. (2004). "200-Mbps optical integrated circuit design and first iteration realizations in 0.8 micron bi-CMOS silicon integrated circuitry", *Proc SPIE*. Vol. 5357, p. 6.
- Soref, R., "Applications of Silicon-Based Optoelectronics", In : *MRS Bulletin*, (1998), pp. 20-47.
- Tessera, Charlotte, USA, (2011), as available at www.tessera.com.
- Vogel, U., Kreye, D., Reckziegel, S, Torke, M., Grillberger, C, & Amelung, J. (2007) "OLED-on-CMOS Integration for Optoelectronic Sensor Applications, In: *Silicon Photonics II*, edited by Joel Kubby, G Reed, *Proc. of SPIE*, Vol. 6477, pp. 647703-1 to 8 (2007).
- Wada, K. (2004). "Electronics and Photonics convergence on Silicon CMOS Platforms" *Proc. of SPIE* Vol. 5357, pp. 16.
- Zimmermann, H. (1997). "Improved CMOS-integrated Photodiodes and their Application in OEICs", *Proc. IEEE 1997 Workshop on High Performance Electron Devices for Microwave and Opto-electronic Applications*, pp.346-351. King's College, London.

IntechOpen

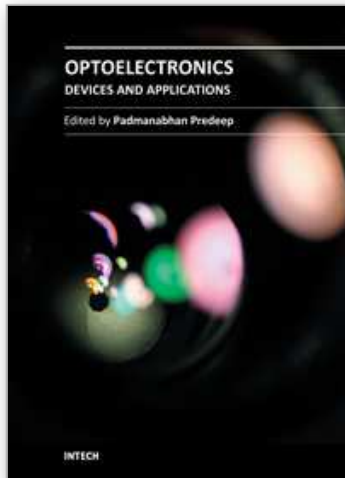

Optoelectronics - Devices and Applications

Edited by Prof. P. Predeep

ISBN 978-953-307-576-1

Hard cover, 630 pages

Publisher InTech

Published online 03, October, 2011

Published in print edition October, 2011

Optoelectronics - Devices and Applications is the second part of an edited anthology on the multifaced areas of optoelectronics by a selected group of authors including promising novices to experts in the field. Photonics and optoelectronics are making an impact multiple times as the semiconductor revolution made on the quality of our life. In telecommunication, entertainment devices, computational techniques, clean energy harvesting, medical instrumentation, materials and device characterization and scores of other areas of R&D the science of optics and electronics get coupled by fine technology advances to make incredibly large strides. The technology of light has advanced to a stage where disciplines sans boundaries are finding it indispensable. New design concepts are fast emerging and being tested and applications developed in an unimaginable pace and speed. The wide spectrum of topics related to optoelectronics and photonics presented here is sure to make this collection of essays extremely useful to students and other stake holders in the field such as researchers and device designers.

How to reference

In order to correctly reference this scholarly work, feel free to copy and paste the following:

Lukas W. Snyman (2011). Integrating Micro-Photonic Systems and MOEMS into Standard Silicon CMOS Integrated Circuitry, Optoelectronics - Devices and Applications, Prof. P. Predeep (Ed.), ISBN: 978-953-307-576-1, InTech, Available from: <http://www.intechopen.com/books/optoelectronics-devices-and-applications/integrating-micro-photonic-systems-and-moems-into-standard-silicon-cmos-integrated-circuitry>

INTECH
open science | open minds

InTech Europe

University Campus STeP Ri
Slavka Krautzeka 83/A
51000 Rijeka, Croatia
Phone: +385 (51) 770 447
Fax: +385 (51) 686 166
www.intechopen.com

InTech China

Unit 405, Office Block, Hotel Equatorial Shanghai
No.65, Yan An Road (West), Shanghai, 200040, China
中国上海市延安西路65号上海国际贵都大饭店办公楼405单元
Phone: +86-21-62489820
Fax: +86-21-62489821

© 2011 The Author(s). Licensee IntechOpen. This is an open access article distributed under the terms of the [Creative Commons Attribution 3.0 License](#), which permits unrestricted use, distribution, and reproduction in any medium, provided the original work is properly cited.

IntechOpen

IntechOpen