

We are IntechOpen, the world's leading publisher of Open Access books Built by scientists, for scientists

4,800

Open access books available

122,000

International authors and editors

135M

Downloads

Our authors are among the

154

Countries delivered to

TOP 1%

most cited scientists

12.2%

Contributors from top 500 universities



WEB OF SCIENCE™

Selection of our books indexed in the Book Citation Index
in Web of Science™ Core Collection (BKCI)

Interested in publishing with us?
Contact book.department@intechopen.com

Numbers displayed above are based on latest data collected.

For more information visit www.intechopen.com



PAC/UF for Removing Cyanobacterial Cells and Toxins from Drinking Water

Margarida Campinas and Maria João Rosa

*Urban Water Division, Department of Hydraulics and Environment
LNEC - National Laboratory for Civil Engineering, Lisbon,
Portugal*

1. Introduction

Cyanobacterial blooms seasonally arise as a concern to some drinking water suppliers due to the massive input of cells, the release of algogenic organic matter (AOM) into the water and often the production of cyanotoxins as secondary metabolites. Cyanotoxins may cause a wide range of adverse health effects, including skin irritation, neurotoxic damage, gastroenteritis, liver damage, tumour promotion and ultimately death, and their removal is therefore a major goal in water treatment.

An optimal water treatment requires the removal of intact cyanobacterial cells (particulate matter) (Drikas et al., 2001), given that cyanotoxins are largely intracellular and cell-bound, as well as the removal of soluble compounds, since there is always a fraction of cyanotoxins that is released into the water by cell-ageing or induced cell damage (Sivonen & Jones, 1999; Pietsch et al., 2002). Conventional treatment is considered ineffective for the removal of dissolved cyanotoxins, making the study and implementation of alternative technologies crucial to minimise or eliminate their negative impact.

Hybrid membrane processes of PAC/UF (powdered activated carbon adsorption/ultrafiltration) were recently developed for controlling pesticides, taste and odour compounds and disinfection-by-products in drinking water treatment. PAC/UF combines the PAC ability to adsorb organics, e.g. dissolved toxins, with the effective removal of particles by low-pressure UF membranes, including cyanobacterial cells and the associated intracellular and cell-bound toxins. Despite its high potential for controlling cyanobacteria and cyanotoxins in drinking water, there is a lack of knowledge regarding PAC/UF application on this environmental-health issue.

This chapter addresses the removal of cyanobacterial cells and toxins from drinking water by PAC/UF hybrid process, focusing on the main questions involving each technology and the singularities of these environmental-health hazards. The chapter summarises the results of a comprehensive study performed with a commercial fine-grade mesoporous PAC and a lab-scale UF apparatus. Laboratory cultured cells of *Microcystis aeruginosa* and the associated microcystins were studied.

M. aeruginosa is one of the most commonly occurring cyanobacteria and grows in laboratory as single cells, which is an advantage for this study. Due to its small size, *M.*

aeruginosa single cells represent the size of algae that is more prone to escape from a conventional water treatment plant. In addition, they may be used as surrogate to assess the removal efficiency of particles of problematic size range (3-10 μm), like *Giardia* cysts and *Cryptosporidium* oocysts. This cyanobacterium produces microcystins – cyclic peptides very relevant for drinking water supply as they are chemically stable, have both acute and chronic effects (hepatotoxic and tumour-promoting) and are the most widely spread cyanotoxins in freshwaters (Sivoven & Jones, 1999). Furthermore, microcystins are the cyanotoxins for which the World Health Organization (WHO) derived a drinking water provisional guideline value (1 $\mu\text{g/L}$ for daily exposure to the microcystin-LR), adopted as national standard for drinking water quality in many countries, including Portugal.

One of the aims of this chapter is to evaluate the UF performance for removing laboratory grown *M. aeruginosa* cells under different growth ages, with special attention to cell damaging and subsequent degradation of the permeate quality. Cell lysis and AOM effects are actually the most controversial issues related with the removal of algal cells by conventional treatment. Some authors refer the occurrence of cell lysis and release of intracellular material into water (Himberg et al., 1989; Hruday et al., 1999; Pietsch et al., 2002) while others report no effect on cell integrity (Chow et al., 1999; Drikas et al., 2001; Ribau Teixeira & Rosa, 2006, 2007). Membrane filtration is referred as an attractive technology to reach high removal efficiencies of microalgae (Chow et al., 1997; Mouchet & Bonnelye, 1998; Hudrey et al., 1999; Pietsch et al., 2002; Gijbetsen-Abrahamse et al., 2006), however studies on its effect on cell integrity are rather scarce. A few studies pointed to a small portion of cells damaged by UF, with 0-2% increase of cell bound microcystin release detected in the permeate (Chow et al., 1997; Gijbetsen-Abrahamse et al., 2006). Yet, the same studies recommend further investigation, particularly in what concerns the cell sensitivity to shear stress and the toxin release into water, phenomena that are both largely affected by the cyanobacterial cell age.

An additional purpose is to investigate the membrane foulant behaviour of the PAC itself and to analyse if different fractions of natural organic matter (NOM) interfere and change the overall PAC effect on the UF performance. PAC contribution to the fouling control by AOM in PAC/UF hybrid process is also assessed. The state-of-the-art concerning PAC effect on membrane fouling is contradictory, some authors reporting a positive impact on permeate flux, duration of filtration cycles or chemical washing frequency (Adham et al., 1991; Konieczny & Klomfas, 2002; Lee et al., 2007) and others presenting similar flux behaviour (Yiantios & Karabelas, 2001; Tomaszewaska & Mozia, 2002; Matsui et al., 2006) or exacerbated flux decline (Lin et al., 1999; Li & Chen, 2004; Zhao et al., 2005; Zularisam et al., 2007). Besides membrane hydrophobicity, raw water diversity is often used to explain the differing PAC effects on membrane fouling, but a complete understanding is lacking.

The final objective of this chapter is to investigate the removal of *M. aeruginosa* cells and microcystins from natural waters by PAC/UF and to compare this process performance with the often used PAC application to conventional clarification by coagulation/flocculation/sedimentation (C/F/S). PAC addition is an attractive option to overcome the limited removal of dissolved microcystins by C/F/S and UF. Nevertheless, PAC adsorption is strongly influenced by NOM size and character (Cook et al., 2001; Li et al., 2003; Campinas & Rosa, 2006) and by NOM interaction with water background inorganics (Campinas & Rosa, 2006), which may significantly reduce the adsorption kinetics and capacity. As so, competitive adsorption is site-specific, and must therefore be studied with the natural water to be treated. In addition, cyanobacterial cells and toxins challenge

the coagulation and UF performances. Both processes may lyse cyanobacterial cells, with a deleterious effect on treated water. Coagulation is particularly inhibited by high AOM concentration and protein-like compounds, whose concentration increases during cell lysis (Takaara et al., 2007). Hydrophilic AOM, such as polysaccharide-like compounds, may be responsible for high membrane fouling (Kimura et al., 2006; Lee et al., 2006; Yamamura et al., 2007). A comparative analysis of PAC/UF and PAC+C/F/S for removing cyanobacterial cells and toxins is therefore essential although ultimately missing.

2. Experimental

2.1 Cyanobacterial cells and toxins

M. aeruginosa culture (Pasteur Culture Collection, PCC 7820) was grown in the laboratory, in BG11 medium, at 23-24°C, under a light regimen of 12 h fluorescent light, 12 h dark. Depending on the experiment, cultures were harvested at different growth ages, namely 1, 2-3 and 4 months, corresponding to exponential phase, late exponential phase and stationary phase, respectively (Campinas & Rosa, 2010a), and used to simulate cyanobacterial blooms. Cyanotoxins are produced at all stages of cyanobacterial growth and usually stay inside the cell (intracellular) until age or stress-driven cell lysis causes their release into the water (extracellular) (Sivonen & Jones, 1999). Throughout the growth phases, there are dissimilarities in the cyanobacterial biomass, AOM production, total cyanotoxin content, and in the intra-/extracellular cyanotoxin ratio. Microcystins are cyclic heptapeptides that share a general structure containing five fixed amino acids and two variable L- amino acids, designated as X and Z. The most commonly occurring microcystin contains leucine in position X and arginine in position Z, and is therefore called MC-LR (Lawton & Edwards, 2001). The studied strain of *M. aeruginosa* produces four microcystin variants (MC-LR, -LY, -LW, -LF), with a dominance of MC-LR, which were used to supplement the assayed waters with the target contaminant. Microcystins are relatively hydrophobic hepatotoxins, with 985-1024 g/mol, depending on the variant, and a net negative charge at pH 6-9 (-1 for MC-LR, -2 for the other variants) (Newcombe et al., 2003).

2.2 Feed waters

The results presented in sections 3.1 and 3.2 are relative to *M. aeruginosa* suspensions prepared by spiking a background electrolyte with a predetermined volume of *M. aeruginosa* culture to obtain a chlorophyll-a concentration of ca. 20 µg/L (Table 1). This concentration aims to simulate a weak bloom or a strong bloom after preliminary treatment, i.e. it is less than half the guidance level 2 for recreational waters and ten times the WHO alert level 1 for drinking waters (Bartram et al., 1999). Cultures harvested at different growth ages (1, 2, 3 and 4 months old) were used to test different cell vulnerabilities. To avoid osmotic shock which may result in cyanobacterial cell lysis, the cells were spiked in a background electrolyte prepared with deionised water amended with potassium chloride until the water conductivity reached ca. 260 µS/cm. The pH was also corrected to 7.0 ± 0.3 with KOH and H₂SO₄.

The experiments discussed in section 3.3 used deionised water with 2.5 mM background ionic strength (KCl+CaCl₂). Results in section 3.4 were obtained with solutions of algal organic matter, both as extracellular organic matter excreted during cyanobacterial growth (EOM) and as AOM, which includes EOM and the intracellular organic matter released during cell lysis.

Suspension	pH	EC ($\mu\text{S}/\text{cm}$)	Turbidity (NTU)	Chl-a ($\mu\text{g}/\text{L}$)	TOC (mgC/L)	MC-LR _{eq} ($\mu\text{g}/\text{L}$)	
						Extra	Intra
1 month	7.2	310	5.3	28.0	2.2	8.9	--
2 months	6.7	293	2.5	20.6	--	0.6	1.5
3 months	7.3	294	3.4	20.0	3.4	2.9	--
4 months	6.7	301	2.8	19.2	--	0.5	2.1

EC: electrical conductivity; Chl-a: chlorophyll-a

Table 1. Characteristics of *M. aeruginosa* suspensions used in the UF experiments discussed in sections 3.1 and 3.2.

EOM and AOM filtrates were prepared from a *M. aeruginosa* culture following Takaara's procedure with the adaptations described by Campinas and Rosa (2010b). Specific volumes of EOM and AOM filtrates were used to prepare the UF feed solutions with a total organic carbon (TOC) concentration of ca. 4 mgC/L (Table 2). Given the high content of salts in EOM solutions, no further salts were added, besides those involved in the pH adjustment to ca. 7. In AOM solutions, the conductivity was completed to ca. 300 $\mu\text{S}/\text{cm}$ with KCl and the pH was adjusted to 7.

The low value of the specific UV absorbance (SUVA) indicates that algal derived organic matter has a dominance of the hydrophilic fraction, a result in agreement with those of Her et al. (2004) and Henderson et al. (2008). On the other hand, Henderson's characterisation of *M. aeruginosa* EOM points to an AOM solution most likely composed of two fractions: a high molar mass fraction (> 100 kDa), dominated by hydrophilic polysaccharides and hydrophobic proteins, and a low molar mass fraction (< 1 kDa). Regarding the EOM solution, it should have an alike composition, but with a larger carbohydrates/DOC (dissolved organic carbon) ratio and with some minor part of hydrophobic proteins (Campinas & Rosa, 2010b).

NOM solution	pH	EC ($\mu\text{S}/\text{cm}$)	TOC (mgC/L)	SUVA ($\text{L}/(\text{m}.\text{mgC})$)
EOM	7.2	831	4.5	1.3
AOM	7.2	288	3.7	1.0

Table 2. Characteristics of the AOM solutions used in UF experiments discussed in section 3.4.

Ozonated water collected at Tavira's Water Treatment Plant (western Algarve, Portugal) was used in section 3.5 trials. This water had neutral pH (7.5), low concentration of organic matter (2.3 mgC/L TOC; 2.1 mgC/L DOC), low SUVA values (0.7 L/(m.mgC)), low alkalinity (40 mg CaCO_3/L) and hardness (51 mg CaCO_3/L). Given the low SUVA value, NOM was essentially hydrophilic and with low molar mass (Edzwald & Van Benschoten, 1990).

Ozonated water was spiked with a predefined volume of *M. aeruginosa* culture until a chlorophyll-a concentration of ca. 10 $\mu\text{g}/\text{L}$ was achieved (Table 3), corresponding to guidance level 1 for recreational waters and ten times higher than WHO alert level 1 for drinking waters (Bartram et al., 1999). A specific volume of microcystins stock-solution was also added to adjust the concentration of dissolved cyanotoxins to ca. 5-8 $\mu\text{g}/\text{L}$ MC-LR_{eq}.

Parameter	
pH	7.3-7.5
EC ($\mu\text{S}/\text{cm}$)	169-211
Turbidity (NTU)	2.1-3.0
UV _{254nm} (cm^{-1})	0.016-0.041
Chl-a ($\mu\text{g}/\text{L}$)	11-12
Extra MC-LR _{eq} ($\mu\text{g}/\text{L}$)	5.6-7.1
Intra MC-LR _{eq} ($\mu\text{g}/\text{L}$)	1.4-1.6

Table 3. Characteristics of the feed water used in section 3.5 trials (ozonated water spiked with *M. aeruginosa* culture and dissolved microcystins).

2.3 PAC

PAC/UF experiments used Norit SA-UF, a highly mesoporous PAC, with a point of zero charge of 9.6 (Campinas & Rosa, 2006). Norit SA-UF small average particle diameter (6 μm) makes it suitable for circulating within the narrow UF hollow-fibres. Its large pore size distribution (38% of primary micropore volume, 22% of secondary micropore volume and 40% of mesopore volume) (Li et al., 2002) has proved to be advantageous for the removal of microcystins (Donati et al., 1994; Huang et al., 2007). Norit SA-UF was not used in C/F/S experiments since its extremely fine grade makes it inadequate for efficient retention by a conventional separation process. C/F/S experiments were therefore performed with Filtracarb WP7, the PAC used in Tavira's WTP. Pore size distribution was not available, however WP7 has an iodine number of 850 g/g and a methylene blue adsorption capacity of 180 mg/g.

2.4 Membrane

An Aquasource cellulose acetate hollow-fibre (inside-out configuration) membrane was used in UF experiments. This UF hydrophilic membrane has a molar mass cut-off of 100 kDa and a hydraulic permeability of 250 L/(h.m².bar) (manufacturer data). The module (16 fibres, 1.1 m length and 0.93 mm internal diameter; 0.05 m² total membrane area) was operated in a cross-flow filtration mode using the inside-out configuration during the filtration cycles and under outside-in flow during backwashing. The manufacturer recommends a maximum UF pressure of 1.5 bar and a maximum backflushing pressure of 2.5 bar. The module was mounted in the lab system schematically illustrated in Figure 1.

2.5 UF and PAC/UF runs

The membranes were first washed, flushed and compacted with deionised water until achieving a steady permeate flux at the pressure and cross-flow velocity to be used in the experiments.

UF runs were performed at a constant permeate flow (3.5 L/h), an initial transmembrane pressure (TMP) of 0.65 bar and a cross-flow velocity of 0.5 m/s, corresponding to a Reynolds number of 463 at 20°C (1 m/s was tested only once). A feed glass tank (FT) fed the raw water to the recirculating tank (RT) through a peristaltic pump at a constant flow of 3.5 L/h to balance the permeate outflow. The concentrate was conducted to RT and blended with the additional feed water from FT, whereas the permeate was continuously collected in a beaker until a 1 L sample was obtained. By that time, RT was sampled to characterise the UF feed water. Filtration cycles lasted 1 h (four samples of permeate were always collected).

Individual concentrations were determined and, whenever necessary for data interpretation, cycle-averaged values (0-60 min) were computed. After each filtration run, the membranes were washed with a 5 mg/L (as Cl₂) sodium hypochlorite solution to inhibit the biological activity on the UF system, and thoroughly flushed with deionised water.

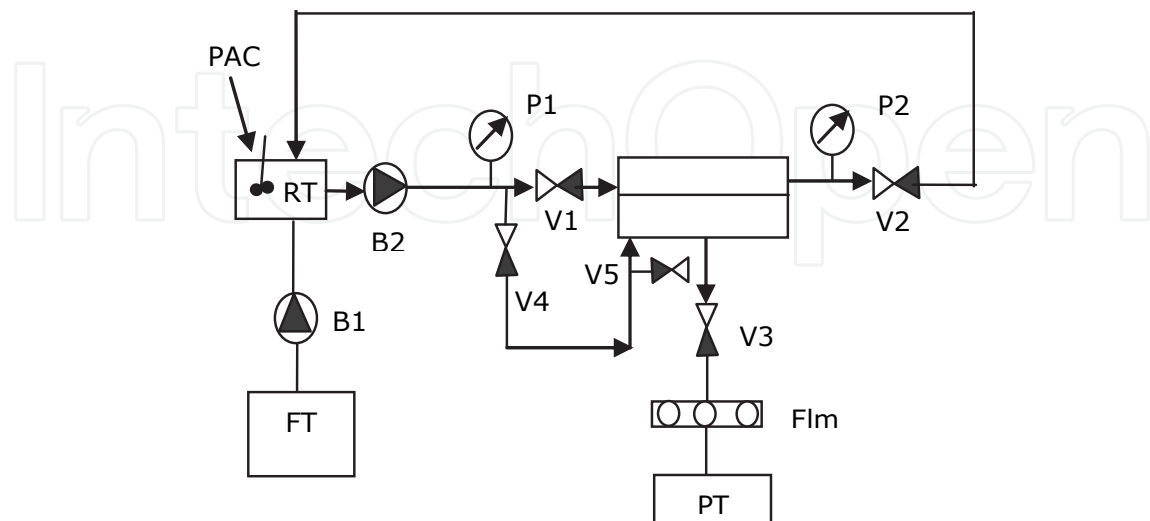

Fig. 1. Flow diagram of UF apparatus (FT - Feed tank; RT - Stirred recirculating tank; PT - Permeate tank; Flm - Flowmeter; P - Manometers; B1 - Peristaltic pump; B2 - Positive displacement pump; V1, V4, V5 - Valves for backwashing; V2 - Concentrate valve; V3 - Permeate valve).

In PAC/UF experiments, PAC was directly added to the feed tank that was continuously stirred at 150 rpm. The total mass of PAC was always added at the beginning of the filtration cycle, and was only discarded at the end of the run. PAC doses of 5 and 10 mg/L were tested. During time-depending fouling runs with AOM (section 3.4), the concentrate and permeate were both recycled back to the feed tank during two hours and permeate samples were collected at given time intervals (after 30 min., 1 and 2 hours of filtration).

Given the difficult accurate control of the permeate flow (since no automatic control was available), there were some minor oscillations of flow during the UF runs. Hence, membrane permeability rather than transmembrane pressure was represented as a function of time. Membrane permeability is given by $Q_p/(\Delta P \cdot A_m)$, where Q_p is the permeate flow (L/h), ΔP is TMP (bar) and A_m is the membrane area (m²).

2.6 PAC+C/F/S experiments

PAC+C/F/S experiments were performed in a laboratory jar test apparatus with four flat paddles (Flocumatic, Selecta). Operating conditions were as follows: a) rapid mixing at 104 rpm (196 s⁻¹ velocity gradient) for 3 min; b) slow mixing at 20 rpm (17 s⁻¹) during 20 min; c) 1 h settling period. The aluminium polychloride coagulant PAX XL-14 (Quicom) was used at 50 mg/L. This dose is 2 to 2.5 times higher than the value used during Tavira's WTP regular operation (i.e. in the absence of cyanobacterial events), and was determined from earlier C/F/S lab tests designed to control the water turbidity during a cyanobacterial bloom with a chlorophyll-a concentration ten times the WHO alert level 1 for drinking water (Bartram et al., 1999). This scenario was simulated in the laboratory by supplementing *M. aeruginosa* culture to Tavira's ozonated water. Filtracarb WP7 PAC was also added during the rapid mixing, after

2 min of coagulation. An effective PAC contact time of 21 min was therefore ensured. Mixing conditions, coagulant type and conditions of PAC application were adjusted from Tavira's WTP. PAC+C/F/S trials were performed in duplicate. A PAC dose of 10 mg/L was tested.

2.7 Analytical methods

Samples were analysed for pH (at 20°C, WTW 340 pH meter), electrical conductivity (EC at 25°C, Crison GLP 32 conductimeter), turbidity (HACH 2100N turbidimeter of high resolution, 0.001 NTU), total and dissolved organic carbon (TOC, DOC) (measured as non-purgeable organic carbon by high temperature combustion method in a Shimadzu TOC 5000A), chlorophyll-a and UV_{254nm} (Beckman DU 640B UV/VIS spectrophotometer) using standard methods of water analysis. DOC and UV_{254nm} were determined on pre-filtered samples through 0.45 µm filters. For chlorophyll-a analysis, samples were filtered through GF/F filter paper and the chlorophylls were extracted using 10 mL acetone (90%). The optical densities of the extracts were measured at 665 nm and 750 nm using a Beckman DU 640B UV/VIS spectrophotometer and chlorophyll-a concentration was computed from Lorenzen equations (1967). Dissolved and intracellular microcystins were analysed by high performance liquid chromatography with photo-diode array detection (HPLC-PDA Dionex Summit System) following Meriluoto and Spoof's procedures (2005a, b, c) with the adaptations detailed by Ribau Teixeira and Rosa (2007). The overall concentration of microcystins was quantified as MC-LR_{eq}.

3. Results

3.1 Retention of cyanobacterial cells

A first set of trials was performed to evaluate the UF removal of *M. aeruginosa* cells under different growth ages. *M. aeruginosa* was obtained from laboratory cultures growing as single cells, whereas in natural environment they grow mainly as colonies. This different morphology was considered an advantage, since single cells are the smallest cyanobacteria and must therefore be the most difficult to retain by a solid-liquid separation. Furthermore, single cells may be used as surrogate to assess the removal of *Giardia* cysts and *Cryptosporidium* oocysts (Vlaski et al., 1996).

The removal efficiency of cyanobacterial cells was assessed through chlorophyll-a and turbidity measurements. Figure 2 depicts the cycle-averaged concentrations of chlorophyll-a and turbidity in the feed and permeate, during the UF cycles performed with *M. aeruginosa* cells 1, 2, 3 and 4 months old.

Results show the high quality of the permeate, i.e. turbidity was always below 0.1 NTU and chlorophyll-a was never detected in the permeate. Even though the feed turbidity varied between 2.8 ± 0.4 NTU and 5.3 ± 0.9 NTU, and chlorophyll-a between 28 ± 6 µg/L and 40 ± 14 µg/L during the UF filtration cycles, the rejections were always high, namely above 97% for turbidity and a complete rejection of chlorophyll-a. These results indicate an absolute removal of *M. aeruginosa* cells and confirm that UF is a safe barrier against cyanobacteria and protozoa, as reported in the literature (Ottoson et al., 2006). UF results of cell retention were already expected since cyanobacterial cells are 400-600 times larger than the membrane pores (4 - 6 µm vs. 0.01 µm; Chow et al., 1997), and are substantially higher than the algal removal efficiencies reported for conventional separation by C/F/S (69-99%) (Vlaski et al., 1996; Ribau Teixeira & Rosa, 2006, 2007) or even by C/F/dissolved air flotation (92-99%) (Ribau Teixeira & Rosa, 2006, 2007, 2010).

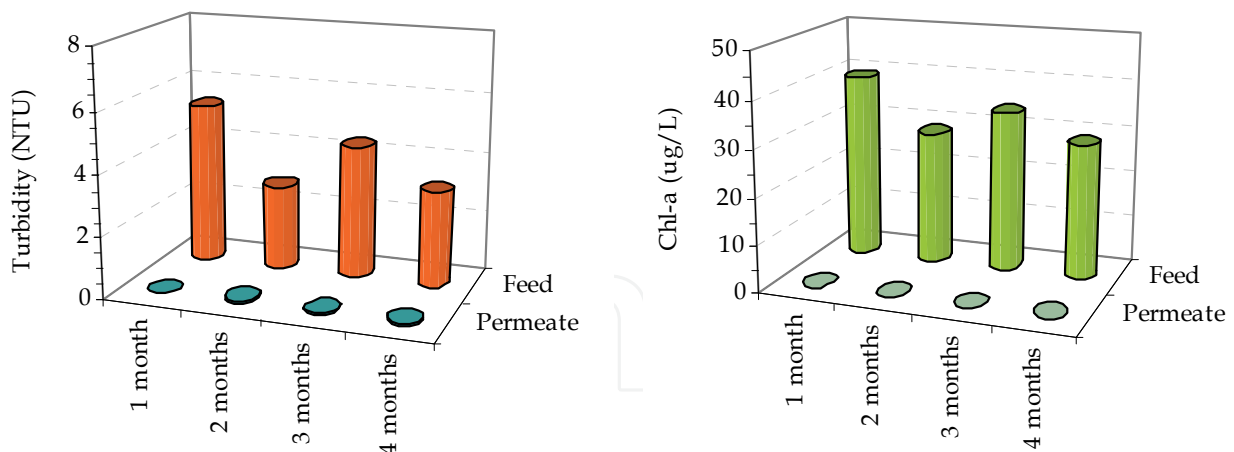

Fig. 2. Turbidity and chlorophyll-a cycle-averaged concentrations on the feed and permeate during constant flow runs with *M. aeruginosa* cells 1, 2, 3 and 4 months old.

3.2 Cell lysis

Experiments were performed to investigate cyanobacterial cell damaging during UF cycles (due to shear stresses developed at the membrane surface or from pumping) and subsequent release of intracellular cyanotoxins and AOM into the permeate.

Preliminary UF runs with model solutions of microcystins revealed a low adsorption of microcystins by the cellulose acetate membrane (4% average rejection (Campinas & Rosa, 2010a)). It was thus decided to indirectly assess cell lysis through the evolution of the dissolved microcystin concentration in the feed and permeate during the filtration cycle. A first set of experiments was performed with *M. aeruginosa* cultures 1 and 3 months old, and the dissolved microcystins concentration was monitored in the feed and in permeate. The resulting cycle-averaged rejections are presented in Figure 3.

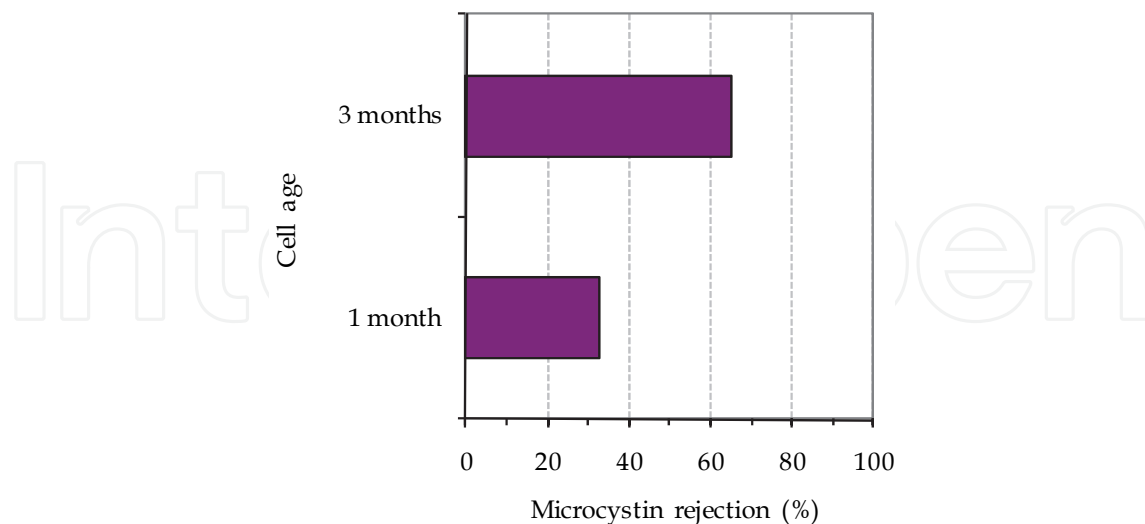

Fig. 3. Cycle-averaged rejection of dissolved microcystins during constant flow runs with *M. aeruginosa* cells 1 and 3 months old.

Figure 3 shows a cycle-averaged rejection of microcystins of 33% with 1 month old cells and 65% with 3 months old cells. The studied microcystins are relatively hydrophobic

compounds with a molar mass (985–1024 Da) much below the cut-off of the hydrophilic membrane (100 kDa), making rejection through sieving not an option, but probably through adsorption. As single-solute solutions of microcystins revealed their low adsorption onto the studied UF membrane, a reasonable explanation for the microcystins rejection exhibited by both cultures is the AOM-microcystins interaction, which confers rejection properties to the hydrophilic membrane. Due to this AOM-driven microcystins adsorption onto the UF membrane, cell lysis assessment based only on the time progression of the dissolved microcystin concentration in the feed and permeate is not suitable and underestimates the cell lysis phenomenon (cell lysis and microcystins adsorption may happen simultaneously). The first set of results prompted the replication of the experiments one month later. This is, by the time of the second set of trials the cultures were 2 and 4 months old. This time, cell lysis was assessed through the evolution of intra-microcystin and chlorophyll-a contents in the feed during the filtration cycle. The results were analysed through concentration factors ($C_f = C/C_0$), comparing the experimental C_f values with the expected ones (Figure 4). The latter were computed by mass-balance equation assuming complete rejection, no adsorption and no cell lysis. Experimental C_f values lower than expected C_f values were therefore interpreted as cell lysis.

Figure 4 shows the occurrence of cell lysis in both cultures, with a stronger impact in the older culture and at the end of the filtration cycle. Chlorophyll-a concentration is not shown but was less sensitive to cell lysis than the intra-microcystins concentration (Campinas & Rosa, 2010a). On the other hand, Figure 5 reveals a cycle-averaged rejection of total microcystins of 60% with the 2 months old culture and of 80% with the 4 months old cells, which indicates the importance of the adsorption phenomenon for this older culture. In parallel to cell damage, an enhancement of microcystin rejection by the UF cellulose acetate membrane must occur with cell ageing, probably associated with the greater content in segregated AOM (mucopolysaccharides) and/or protein lysed AOM of older cultures. Consequently, the permeate quality did not degrade at all with the oldest culture (39% of dissolved microcystin rejection) and suffered only a minor degradation with the youngest culture (-4% of dissolved microcystin rejection).

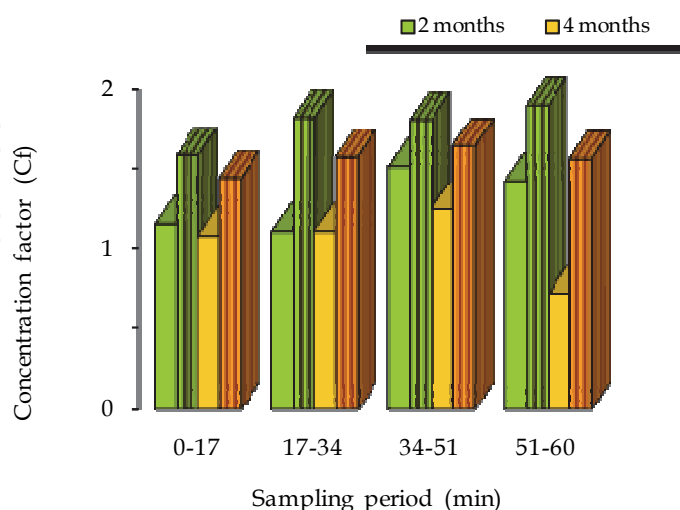

Fig. 4. Concentration factors for intracellular microcystins during filtration cycles with *M. aeruginosa* cells 2 and 4 months old: experimental (full) and expected (striped) values based on mass-balance equations.

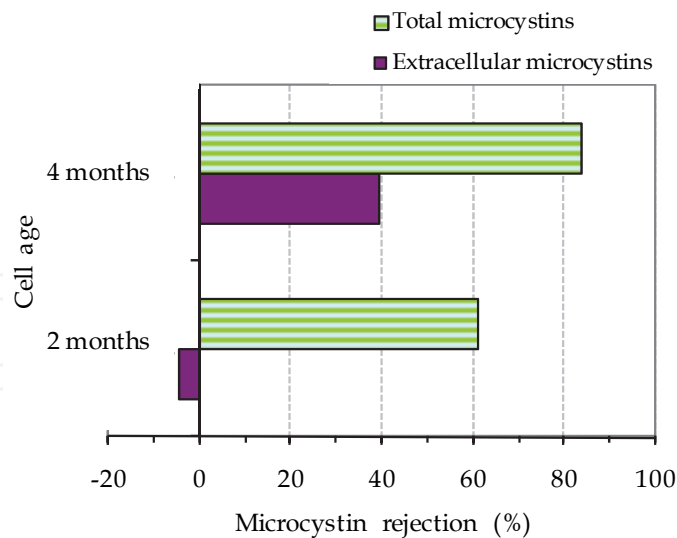

Fig. 5. Cycle-averaged rejection of total and dissolved microcystin during constant flow runs with *M. aeruginosa* cells 2 and 4 months old.

It can be therefore concluded that cell lysis occurs during the UF runs, particularly for older cultures, but this event does not necessarily degrade the permeate quality since in parallel to cell damage an enhancement of microcystin rejection by the UF membrane is observed with cell ageing, probably due to AOM-driven microcystin adsorption on the membrane. Pietsch et al. (2002) obtained also higher cell removals and cell lysis by flocculation of *M. aeruginosa* in the stationary growth phase than with cells in the exponential growth phase.

3.3 UF fouling potential of PAC

Time-depending fouling runs with PAC addition (5 mg/L) were performed with deionised water with 2.5 mM background IS (KCl+CaCl₂) and using two cross-flow velocities (CFV), 0.5 m/s (used in all previous runs) and 1.0 m/s. For comparison purposes, analogous UF runs were carried out with no PAC addition. Figure 6 presents the membrane permeability as a function of time during PAC/UF and UF runs.

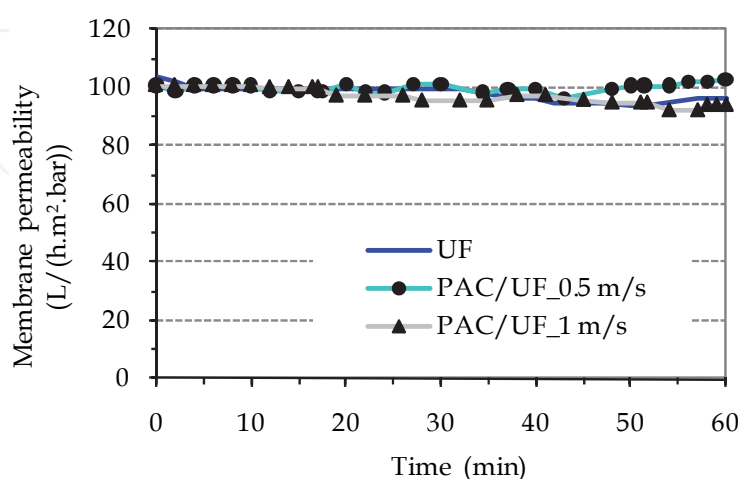

Fig. 6. Membrane permeability during UF and PAC/UF time-depending fouling runs at two cross-flow velocities (UF: no PAC addition; PAC/UF: 5 mg/L PAC).

As explained earlier in section 2.5, it was difficult to manually control the permeate flow, and there were in consequence some minor oscillations, especially at the end of the runs. Nevertheless, the curves with and without PAC almost overlap, meaning that PAC alone did not affect the membrane permeability of the hydrophilic UF membrane. Similar results were obtained during concentration-time depending fouling runs (Campinas & Rosa, 2010b) and by other authors such as Lin et al. (1999), Yantsios & Karabelas (2001), Li & Chen (2004) and Mozia et al. (2005). PAC should deposit on the membrane surface, however the PAC average diameter (6 μm) is probably large enough to avoid membrane pore blocking, forming a porous layer that allows the passage of water with no additional resistance.

Figure 7 displays the normalised turbidity of PAC/UF feed during the time-depending fouling runs at two CFV. With both velocities only a fraction of PAC was recycled as a suspension and just for a short period of time, and even the higher CFV did not yield a higher feed normalised turbidity. A similar PAC deposition rate was observed for both CFVs, a behaviour which is analogous to that found by Crozes et al. (1997) and Matsui et al. (2001). In addition, for the laminar conditions tested, a comparable membrane permeability decrease pattern was observed for CFV 0.5 m/s (Reynolds number of 463, at 20°C) and 1.0 m/s (Reynolds number of 926). As a result, the most cost-effective cross-flow velocity (0.5 m/s) was used in the following experiments.

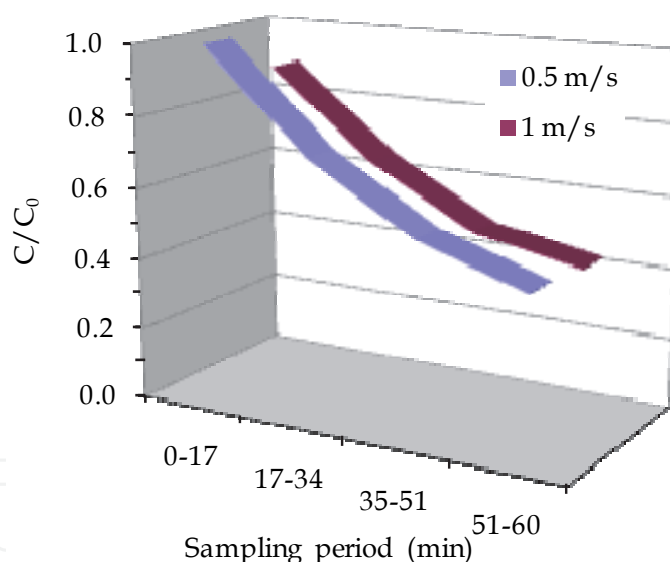

Fig. 7. Normalised turbidity of PAC/UF feed during the time-depending fouling runs at two cross-flow velocities (5 mg/L PAC).

3.4 AOM fouling potential in PAC/UF

Some authors concluded that PAC itself does not impose considerable membrane fouling, yet the presence of NOM acts as glue that binds the PAC particles to one another and to the membrane surface, and increases the fouling resistance (Lin et al., 1999; Li and Chen, 2004). To investigate the combined effect of PAC and AOM on the membrane fouling, UF and PAC/UF (10 mg/L PAC) fouling runs were performed with algogenic organic fractions (AOM and EOM). The normalised flux as a function of time is depicted on Figure 8.

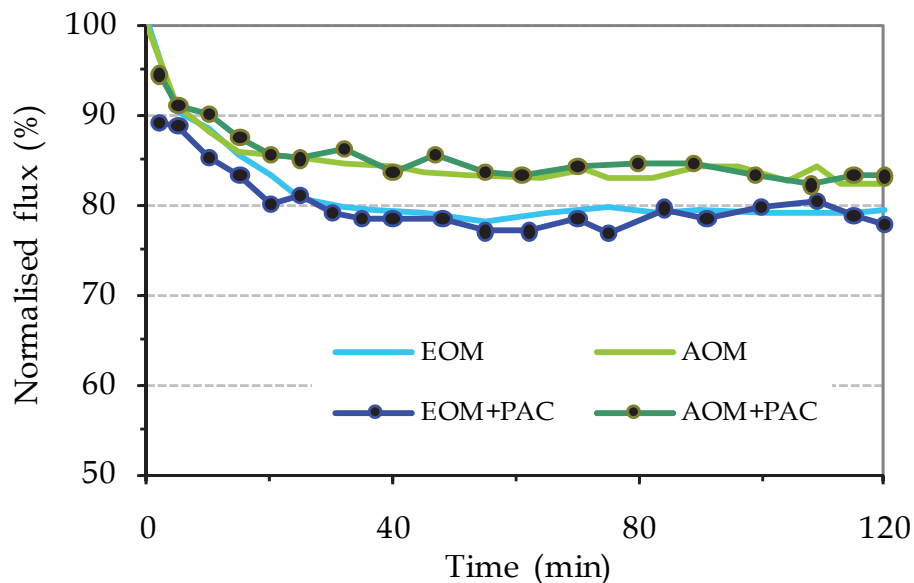

Fig. 8. Normalised flux during PAC/UF (10 mg/L PAC) and UF time-depending fouling runs with algogenic organic fractions (AOM and EOM).

Figure 8 shows no differences at all of the normalised flux with and without PAC addition, which indicates that PAC neither endorsed nor controlled the membrane reversible fouling. The same trend has already been obtained by others (Tomaszewska & Mozia, 2002; Mozia et al., 2005; Matsui et al., 2006;) and differ from the results of Jermann et al. (2008) with NOM-kaolinite, probably due to the larger particle size of Norit SA-UF PAC (6 μm) compared to kaolinite (0.1-2 μm). Figure 8 also shows that the different characteristics of the NOM used in the experiments, i.e. the higher or lower protein content or even the higher salt content in EOM solutions, did not seem to modify the PAC effect on the membrane reversible fouling. A similar behaviour was observed with NOM of different hydrophobicity, such as tannic and humic acids (Campinas & Rosa, 2010b).

EOM run resulted in a more severe membrane fouling than the AOM run, yielding a flux decline of 21% after 2 h of operation, somewhat higher than the AOM-driven flux decline (18%). Other authors have also obtained a high fouling potential of hydrophilic NOM, as that prevailing in AOM and EOM fractions (Table 2) (Her et al., 2004; Lee et al., 2006; Zularisam et al., 2007).

Figure 9 presents NOM rejections with and without PAC addition. PAC improved the TOC rejection of AOM (35% vs. 55%) and had no major impact on the $\text{UV}_{254\text{nm}}$ absorbing substances of AOM and on TOC and $\text{UV}_{254\text{nm}}$ rejections of EOM constituents. This dissimilar behaviour is most likely justified by the presence of more hydrophobic compounds in the AOM fraction, causing the PAC-driven enhancement of TOC rejection. It seems that the highly hydrophilic compounds of EOM (only expressed by the overall content as TOC, since $\text{UV}_{254\text{nm}}$ is not a good indicator for polysaccharides and aromatic tryptophan-like proteins) were not easily adsorbed onto PAC, and as such PAC did not improve the membrane reversible fouling.

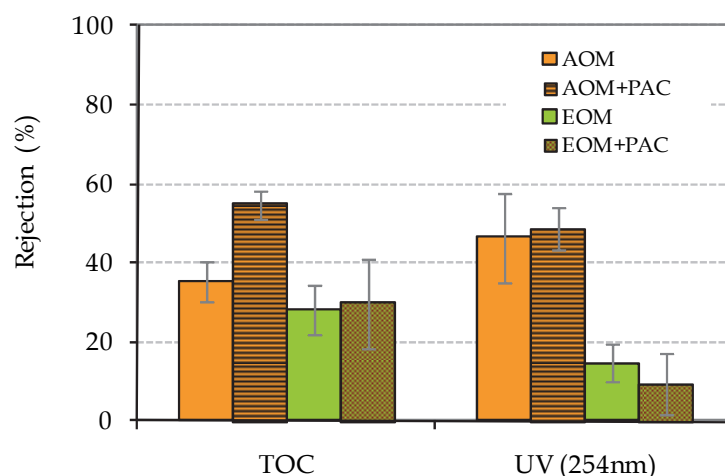

Fig. 9. TOC and UV_{254nm} rejections of algogenic organic fractions during PAC/UF (10 mg/L) and UF fouling runs (error bars represent standard deviations).

Given the higher salt content of EOM solution and the lower TOC and UV_{254nm} rejections, the higher fouling potential of EOM is attributed to interactions between polysaccharide-type compounds and multivalent cations. These interactions prompt a denser fouling layer which results in an augmented overall resistance to water permeation. These observations are in agreement with those found by Jermann et al. (2007) and Katsoufidou et al. (2007) in UF studies with alginate (a typical model polysaccharide used as EOM surrogate) in the presence of calcium.

3.5 Comparing UF, PAC/UF and PAC+C/F/S

The performance of UF, PAC+C/F/S and PAC/UF was compared for removing *M. aeruginosa* cells and microcystins from soft to moderately hard natural waters with hydrophilic low molar mass organics (Table 3). PAC/UF and PAC+C/F/S used the same PAC dose (10 mg/L) but different PAC type (Norit SA-UF and Filtracarb WP7, respectively) and effective PAC contact time (1 h and 21 min, respectively) representing the real full-scale scenario.

Figure 10 shows that all processes ensured an absolute removal of *M. aeruginosa* cells and chlorophyll-a was never detected in the treated water. Although a much lower size of the PAC carbon was used (6 μm), PAC/UF process attained a safer removal of particles, as turbidity was always below 0.1 NTU, much below the 0.48 NTU obtained with PAC+C/F/S (> 98% turbidity rejection by UF and PAC/UF vs. 84% by PAC+C/F/S). Between UF and PAC/UF there were some clear differences, in particular a negative rejection of dissolved microcystins and UV_{254nm} (-2% and -20%, respectively) was observed with UF, most likely due to cell lysis (Campinas & Rosa, 2010c). Comparing both processes with PAC addition, i.e. PAC/UF and PAC+C/F/S, greater removal of microcystins (intra and extracellular) was achieved by PAC/UF (90% vs. 36%). A reasonable explanation is the longer PAC effective contact time and the use of smaller PAC particles in PAC/UF process, thus providing longer adsorption time and faster kinetics. According to Cook et al. (2001) and Ho & Newcombe (2005), PAC application to a conventional clarification has the disadvantages of low contact time with suspended carbon (since during settling there is minimal or no adsorption) and floc interference with

PAC adsorption capacity, i.e. PAC is incorporated into the flocs and diffusion kinetics are reduced.

On the other hand, conventional clarification showed greater UV_{254nm} removals than PAC/UF (66% vs. 39% removal, Figure 10), which is thought to be connected with the cell lysis occurrence during UF cycles, causing a deleterious effect on the permeate quality (and responsible for the -20% UV_{254nm} rejection in UF runs). PAC/UF improved the UF permeate quality in terms of UV_{254nm} but was unable to reach the PAC + C/F/S quality. These results reflect the preferential coagulation of high molar mass compounds, a feature that benefits the C/F/S process, even if in the present study the conventional clarification was designed for particle removal by adsorption/neutralisation rather than for NOM enhanced coagulation.

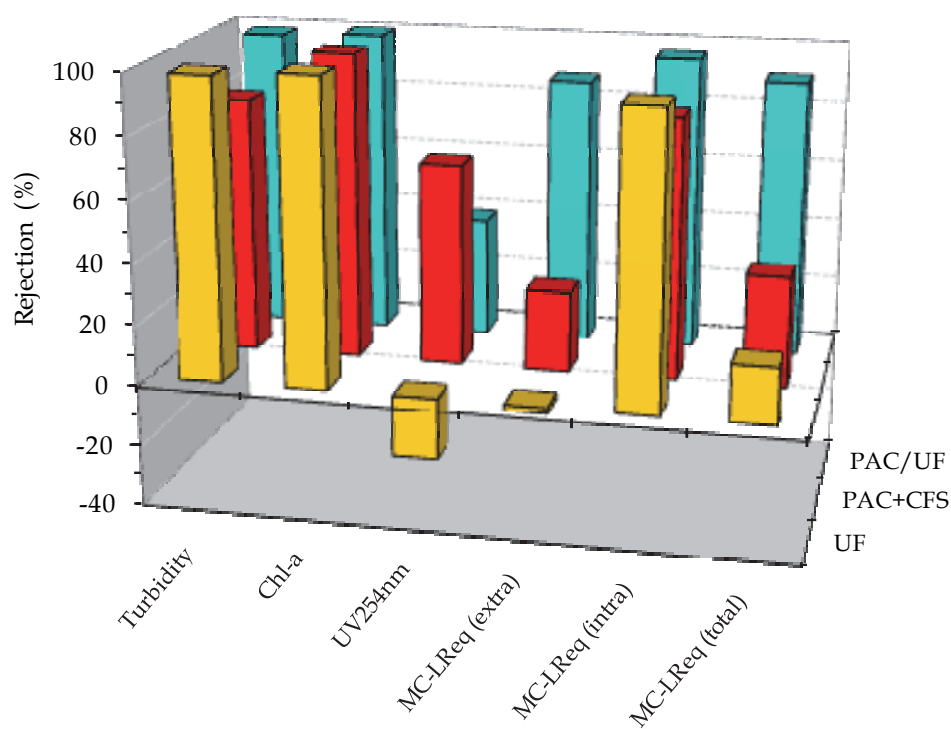

Fig. 10. UF, PAC+C/F/S and PAC/UF performances with ozonated water supplemented with *M. aeruginosa* culture and dissolved microcystins ($7.2-8.5 \mu\text{g/L MC-LReq}$, 4-5 extra/intracellular; 10 mg/L PAC).

Figure 11 displays the cycle-averaged concentration of microcystins (intra and extracellular) in UF, PAC+C/F/S and PAC/UF treated waters. The error bars depicted in the figure are standard deviations.

Both UF and conventional application of 10 mg/L PAC were unable to control the microcystins, attaining a permeate concentration of $6.2 \pm 0.1 \mu\text{g/L MC-LReq}$, and $5.4 \pm 0.4 \mu\text{g/L MC-LReq}$ respectively. By opposition, PAC/UF allowed a concentration of $0.72 \pm 0.4 \mu\text{g/L MC-LReq}$ with a PAC dose of 10 mg/L. Higher removal of dissolved microcystins would be expected if cell lysis could be avoided or PAC adsorption improved, e.g. by using higher PAC dosages, smaller PAC particles or longer PAC retention time.

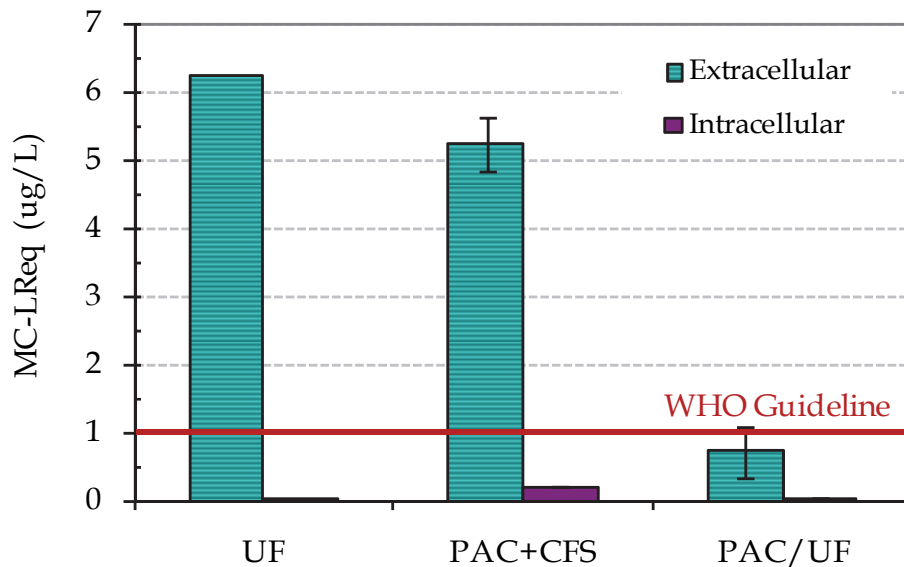

Fig. 11. Cycle-averaged microcystin concentration of treated waters produced by UF, PAC+C/F/S and PAC/UF application to ozonated water supplemented with *M. aeruginosa* culture and dissolved microcystins (7.2-8.5 µg/L MC-LReq, 4-5 extra/intracellular; 10 mg/L PAC).

4. Conclusions

This chapter summarises the results of a comprehensive study of the removal of cyanobacterial cells and toxins from drinking water by PAC/UF hybrid process, focusing on the main questions involving each technology and the singularities of these environmental-health hazards.

The first objective of the present research was to evaluate the UF performance for removing cyanobacterial cells under different growth ages, with special attention to cell damaging and subsequent degradation of permeate quality. The results obtained show UF as a safe barrier against cyanobacteria, ensuring an absolute removal of *M. aeruginosa* single cells, the smallest cyanobacterial cells and hence the most difficult to remove. Data showed an increased cell lysis with cell ageing, although it did not necessarily degrade permeate quality, as in parallel to cell damage an enhancement of microcystin rejection by the UF hydrophilic membrane (of cellulose acetate) was observed with cell ageing. This effect is most probably due to AOM-driven microcystin adsorption on the membrane, connected to the greater content of the older cultures in segregated AOM (mucopolysaccharides) and/or protein lysed AOM.

The second objective of this study was to investigate the foulant behaviour of the PAC itself and to analyse if different NOM fractions change the overall PAC effect on the UF performance. Data of UF time-depending fouling runs showed that UF membrane effectively retained the fine PAC particles and that PAC did not affect the hydrophilic membrane permeability. The different protein and salt contents of the algal organic fractions (AOM and EOM) did not change the PAC effect on the membrane reversible fouling as suggested by some authors.

The third objective was to assess PAC contribution to the fouling control by algogenic organic matter in PAC/UF hybrid process. Data showed that EOM had a greater impact on membrane fouling than AOM, probably due to polysaccharide-like substances interaction with multivalent ions, resulting in dense fouling layers. PAC improved the rejection of hydrophobic AOM but it was apparently ineffective for adsorbing the highly hydrophilic EOM, and as such did not improve the EOM-driven membrane reversible fouling.

This comprehensive study ultimately aimed to investigate the removal of *M. aeruginosa* cells and microcystins from natural waters by PAC/UF and to compare this process with PAC application to conventional clarification (PAC+C/F/S). Data showed that the membrane-based processes (PAC/UF and UF alone) ensured an absolute removal of *M. aeruginosa* cells, and chlorophyll-a was never detected in treated waters. In addition, both UF processes achieved an excellent overall control of particles (turbidity below 0.1 NTU), but PAC/UF remarkably improved the rejection of dissolved microcystins and UV_{254nm} absorbing substances, from negative values observed with UF due to cell lysis, to 87% and 30%, respectively.

Comparing PAC/UF and PAC+C/F/S, the former ensured a significant improvement in turbidity rejection (99% vs. 84%) and especially in total microcystins rejection (90% vs. 36%) and concentration in the treated water (0.72 vs. 5.4 µg/L MC-LR_{eq}), as a result of enhanced adsorption kinetics in PAC/UF (due to longer PAC effective contact time, smaller PAC particles and PAC not incorporated in the flocs). Nevertheless, PAC application to C/F/S achieved higher removal of UV_{254nm} absorbing substances than PAC/UF (66% vs. 39%), justified by privileged coagulation of large compounds and detrimental UF effect on cell integrity. The fouling behaviour of algal organic matter and the cell lysis occurrence during UF, with subsequent release of dissolved microcystins and AOM to water, indicate that UF with no PAC addition is inadequate to treat cyanobacterial-rich waters and highlight the relevance of a roughing clarification step prior to PAC/UF.

5. Acknowledgments

The authors would like to thank the Portuguese Foundation for Science and Technology for providing a Ph.D scholarship to Margarida Campinas (BD/10356/2002). Special thanks are also addressed to Águas do Algarve, SA (Portugal) for partially funding this project.

6. References

- Adham, S., Snoeyink, V., Clark, M. & Bersillon, J.-L. (1991) Predicting and verifying organics removal by PAC in an ultrafiltration system. *Journal of American Water Works Association*, 12, 81-91.
- Bartram, J., Burch, M., Falconer, I., Jones, G. & Kuiper-Goodman, T. (1999). Situation assessment, planning and management. In *Toxic Cyanobacteria in Water: a Guide to Their Public Health Consequences, Monitoring and Management*. World Health Organization (Eds.), E&SPON, London.
- Campinas, M. & Rosa, M.J. (2006). The ionic strength effect on microcystin and natural organic matter surrogate adsorption onto PAC. *Journal of Colloid and Interface Science*, 299, 520-529.

- Campinas, M. & Rosa, M.J. (2010a). Evaluation of cyanobacterial cells removal and lysis by ultrafiltration. *Separation and Purification Technology*, 70, 345-353.
- Campinas, M. & Rosa, M.J. (2010b). Assessing PAC contribution to the NOM fouling control in PAC/UF systems. *Water Research*, 44, 1636-1644.
- Campinas, M. & Rosa, M.J. (2010c). Comparing PAC/UF and conventional clarification with PAC for removing microcystins from natural waters. *Desalination and Water Treatment*, 16, 120-128.
- Chow, C., Panglish, S., House, J., Drikas, M., Burch, M. & Gimbel, R. (1997). A study of membrane filtration for the removal of cyanobacteria. *Journal of Water Supply: Research and Technology - Aqua*, 46(6), 324-334.
- Chow, C., House, J., Drikas, M., House, J., Burch, M. & Velzeboer, R. (1999). The impact of conventional water treatment processes on cells of the cyanobacterium *Microcystis aeruginosa*. *Water Research*, 33(15), 3253-3262.
- Cook, D., Newcombe, G. & Sztajnbock, P. (2001). The application of powdered activated carbon for MIB and geosmin removal: predicting PAC doses in four raw waters. *Water Research*, 35(5), 1325-1333.
- Crozes, G., Jacangelo, J., Anselme, C. & Laine, J. (1997) Impact of ultrafiltration operating conditions on membrane irreversible fouling. *Journal of Membrane Science*, 124(1), 63-76.
- Donati, C., Drikas, M., Hayes, R. & Newcombe, G. (1994). Microcystin-LR adsorption by powdered activated carbon. *Water Research*, 28(8), 1735-1742.
- Edzwald, J. & Van Benschoten, J. (1990). Aluminium coagulation of natural organic material. In *Chemical Water and Wastewater Treatment*. Hahn H.H. and Klute K. (Eds). Berlin: Springer-Verlag.
- Gijsbertsen-Abrahamse, A., Schmidt, W., Chorus, I. & Heijman, S. (2006). Removal of cyanotoxins by ultrafiltration and nanofiltration. *Journal of Membrane Science*, 276, 252-259.
- Henderson, R., Baker, A., Parsons, S. & Jefferson, B. (2008) Characterisation of algogenic organic matter extracted from cyanobacteria, green algae and diatoms. *Water Research*, 42(13), 3435-3445.
- Her, N., Amy, G., Park, H.-R. & Song, M. (2004). Characterizing algogenic organic matter (AOM) and evaluating associated NF membrane fouling. *Water Research*, 38, 1427-1438.
- Ho, L. & Newcombe, G. (2005). Effect of NOM, turbidity and floc size on the PAC adsorption of MIB during alum coagulation. *Water Research*, 39, 3668-3674.
- Hrudey, S., Burch, M., Drikas, M. & Gregory, R. (1999). Remedial measures. In *Toxic Cyanobacteria in Water: a Guide to Their Public Health Consequences, Monitoring and Management*. World Health Organization (Eds.), E&SPON, London.
- Huang, W.-J, Cheng, B.-L. & Vheng, Y.-L. (2007). Adsorption of microcystin-LR by three types of activated carbon. *Journal of Hazardous Materials*, 141, 115-122.
- Jermann, D., Pronk, W., Meylan, S. & Bollner, M. (2007) Interplay of different NOM fouling mechanisms during ultrafiltration for drinking water production. *Water Research*, 41(8), 1713-1722.

- Jermann, D., Pronk, W., Kägi, R., Halbeisen, M. & Boiler, M. (2008) Influence of interactions between NOM and particles on UF fouling mechanisms. *Water Research*, 42(14), 3870-3878.
- Katsoufidou, K., Yiantsios, S. & Karabelas, A. (2007) Experimental study of ultrafiltration membrane fouling by sodium alginate and flux recovery by backwashing. *Journal of Membrane Science*, 300, 137-146.
- Kimura, K., Yamamura, H. & Watanabe, Y. (2006). Irreversible fouling in MF/UF membranes caused by natural organic matters (NOMs) isolated from different origins. *Separation Science Technology*, 41, 1331-1344.
- Konieczny, K. & Klomfas, G. (2002) Using activated carbon to improve natural water treatment by porous membranes. *Desalination*, 147, 109-116.
- Lawton, L. & Edwards, C. (2001). Purification of microcystins. *Journal of Chromatography A*, 912, 191-209.
- Lee, N., Amy, G. & Croué, J-P. (2006). Low-pressure membrane (MF/UF) fouling associated with allochthonous versus autochthonous natural organic matter. *Water Research*, 40, 2357-2368.
- Lee, C., Bae, S., Han, S. & Kang, L. (2007) Application of ultrafiltration hybrid membrane processes for reuse of secondary effluent. *Desalination*, 202, 239-246.
- Li, F., Yuasa, A., Ebie, K., Azuma, Y., Hagishita, T. & Matsui, Y. (2002) Factors affecting the adsorption capacity of dissolved organic matter onto activated carbon: modified isotherm analysis. *Water Research*, 36, 4592
- Li, Q., Snoeyink, V., Mariñas, B. & Campos, C. (2003). Pore blockage effect of NOM on atrazine adsorption kinetics of PAC: the roles of PAC pore size distribution and NOM molecular weight. *Water Research*, 37, 4863
- Li, C.-W. & Chen, Y.-S. (2004) Fouling of UF membrane by humic substances: effects of molecular weight and powder-activated carbon (PAC) pre-treatment. *Desalination*, 170, 59-67.
- Lin, C.-F., Huang, Y.-J. & Hao, O. (1999) Ultrafiltration processes for removing humic substances: effect of molecular weight fractions and PAC treatment. *Water Research*, 33(5), 1252-1264.
- Lorenzen, C. J. (1967) Determination of chlorophyll and pheo-pigments: spectrophotometric equations. *Limnology and Oceanography*, 12(2), 343-346.
- Matsui, Y., Yuasa, A. & Colas, F. (2001) Effect of operational modes on the removal of a synthetic organic chemical by powdered activated carbon during ultrafiltration. *Water Science and Technology: Water Supply*, 1(5/6), 39-47.
- Matsui, Y., Sanogawa, T., Aoki, N., Mima, S. & Matsushita, T. (2006) Evaluating submicron-sized activated carbon adsorption for microfiltration pretreatment. *Water Science and Technology*, 6(1), 149-155.
- Meriluoto, J. & Spoof, L. (2005a). SOP: Solid phase extraction of microcystin in water samples. In *Toxic Cyanobacterial Monitoring and Cyanotoxin Analysis*. J. Meriluoto and G. Codd (Eds.), Abo Akademi University Press, Finland.
- Meriluoto, J. & Spoof, L. (2005b). SOP: Extraction of microcystins in biomass filtered on glass-fibre filters or in freeze-dried cyanobacterial biomass. In *Toxic Cyanobacterial Monitoring and Cyanotoxin Analysis*. J. Meriluoto and G. Codd (Eds.), Abo Akademi University Press, Finland.

- Meriluoto, J. & Spoof, L. (2005c). SOP: Analysis of microcystins by high-performance liquid chromatography with photodiode-array detection. In *Toxic Cyanobacterial Monitoring and Cyanotoxin Analysis*. J. Meriluoto and G. Codd (Eds.), Abo Akademi University Press, Finland.
- Mouchet, P. & Bonnelye, V. (1998). Solving algae problems: French expertise and world-wide application. *Journal of Water Science Research and Technology - Aqua*, 47(3), 125-141.
- Mozia, S., Tomaszewaska, M. & Morawski, A. (2005). Studies on the effect of humic acids and phenol on adsorption-ultrafiltration process performance. *Water Research*, 39, 501-509.
- Newcombe, G., Cook, D., Brooke, S., Ho, L. & Slyman, N. (2003). Treatment options for microcystins toxins: similarities and differences between variants. *Environmental Technology*, 24(3), 299-308.
- Ottoson, J., Hansen, A., Bjorlenius, B., Norder, H. & Stenstrom, T. (2006). Removal of viruses, parasitic protozoa and microbial indicators in conventional and membrane processes in a wastewater pilot plant. *Water Research*, 40, 1449-1457
- Pietsch, J., Bornmann, K. & Schmidt, W. (2002). Relevance of intra and extracellular cyanotoxins for drinking water treatment. *Acta Hydrochimica et Hydrobiologica*, 30(1), 7-15.
- Ribau Teixeira, M. & Rosa, M.J. (2006). Comparing dissolved air flotation and conventional sedimentation to remove cyanobacterial cells of *Microcystis aeruginosa*. Part I: The key operating conditions. *Separation and Purification Technology*, 52, 84-94.
- Ribau Teixeira, M. & Rosa, M.J. (2007). Comparing dissolved air flotation and conventional sedimentation to remove cyanobacterial cells of *Microcystis aeruginosa*. Part II: The effect of water background organics. *Separation and Purification Technology*, 53, 126-134.
- Ribau Teixeira, M. & Rosa, M.J. (2010). Investigating dissolved air flotation performance with cyanobacterial cells and filaments. *Water Research*, 44, 3337-3344.
- Sivonen, K. & Jones, G. (1999). Cyanobacterial toxins. In *Toxic Cyanobacteria in Water: a Guide to Their Public Health Consequences, Monitoring and Management*. World Health Organization (Eds.), E& SPON, London.
- Takaara, T., Sano, D., Konno, H. & Omura, T. (2007). Cellular proteins of *Microcystis aeruginosa* inhibiting coagulation with polyaluminum chloride. *Water Research*, 41, 1653-1658.
- Tomaszewska, M. & Mozia, S. (2002) Removal of organic matter from water by PAC/UF system. *Water Research*, 36, 4137-4143.
- Vlaski, A., Breemen, A. & Alaerts, G. (1996). Optimisation of coagulation conditions for the removal of cyanobacteria by dissolved air flotation or sedimentation. *Journal of Water Science Research and Technology - Aqua*, 45(5), 253-261.
- Yamamura, H., Kimura, K. & Watanabe, Y. (2007). Mechanism involved in the evolution of physically irreversible fouling in microfiltration and ultrafiltration membranes used for drinking water treatment. *Environmental Science and Technology*, 41, 6789-9794.

- Yiantsios, S. & Karabelas, A. (2001) An experimental study of humic acid and powdered activated carbon deposition on UF membranes and their removal by backwashing. *Desalination*, 140, 195-209.
- Zhao, P., Takizawa, S., Katayama, H. & Ohgaki, S. (2005) Factors causing PAC cake fouling in PAC-MF (powdered activated carbon-microfiltration) water treatment systems. *Water Science and Technology*, 51(6-7), 231-240.
- Zularisam, A., Ismail, A., Salim, M., Sakinah, M. & Ozaki, H. (2007) The effects of natural organic matter (NOM) fractions on fouling characteristics and flux recovery of ultrafiltration membranes. *Desalination*, 212, 191-208.

IntechOpen

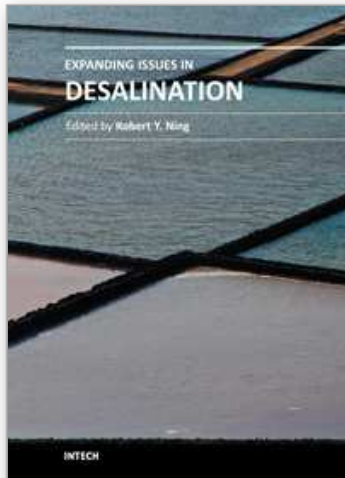

Expanding Issues in Desalination

Edited by Prof. Robert Y. Ning

ISBN 978-953-307-624-9

Hard cover, 412 pages

Publisher InTech

Published online 22, September, 2011

Published in print edition September, 2011

For this book, the term “desalination” is used in the broadest sense of the removal of dissolved, suspended, visible and invisible impurities in seawater, brackish water and wastewater, to make them drinkable, or pure enough for industrial applications like in the processes for the production of steam, power, pharmaceuticals and microelectronics, or simply for discharge back into the environment. This book is a companion volume to “Desalination, Trends and Technologies”, INTECH, 2011, expanding on the extension of seawater desalination to brackish and wastewater desalination applications, and associated technical issues. For students and workers in the field of desalination, this book provides a summary of key concepts and keywords with which detailed information may be gathered through internet search engines. Papers and reviews collected in this volume covers the spectrum of topics on the desalination of water, too broad to delve into in depth. The literature citations in these papers serve to fill in gaps in the coverage of this book. Contributions to the knowledge-base of desalination is expected to continue to grow exponentially in the coming years.

How to reference

In order to correctly reference this scholarly work, feel free to copy and paste the following:

Margarida Campinas and Maria João Rosa (2011). PAC/UF for Removing Cyanobacterial Cells and Toxins from Drinking Water, Expanding Issues in Desalination, Prof. Robert Y. Ning (Ed.), ISBN: 978-953-307-624-9, InTech, Available from: <http://www.intechopen.com/books/expanding-issues-in-desalination/pac-uf-for-removing-cyanobacterial-cells-and-toxins-from-drinking-water>

INTECH
open science | open minds

InTech Europe

University Campus STeP Ri
Slavka Krautzeka 83/A
51000 Rijeka, Croatia
Phone: +385 (51) 770 447
Fax: +385 (51) 686 166
www.intechopen.com

InTech China

Unit 405, Office Block, Hotel Equatorial Shanghai
No.65, Yan An Road (West), Shanghai, 200040, China
中国上海市延安西路65号上海国际贵都大饭店办公楼405单元
Phone: +86-21-62489820
Fax: +86-21-62489821

© 2011 The Author(s). Licensee IntechOpen. This chapter is distributed under the terms of the [Creative Commons Attribution-NonCommercial-ShareAlike-3.0 License](https://creativecommons.org/licenses/by-nc-sa/3.0/), which permits use, distribution and reproduction for non-commercial purposes, provided the original is properly cited and derivative works building on this content are distributed under the same license.

IntechOpen

IntechOpen