

# We are IntechOpen, the world's leading publisher of Open Access books Built by scientists, for scientists

**4,800**

Open access books available

**122,000**

International authors and editors

**135M**

Downloads

Our authors are among the

**154**

Countries delivered to

**TOP 1%**

most cited scientists

**12.2%**

Contributors from top 500 universities



**WEB OF SCIENCE™**

Selection of our books indexed in the Book Citation Index  
in Web of Science™ Core Collection (BKCI)

Interested in publishing with us?  
Contact [book.department@intechopen.com](mailto:book.department@intechopen.com)

Numbers displayed above are based on latest data collected.

For more information visit [www.intechopen.com](http://www.intechopen.com)



## Post-Tx Renal Monitoring with B-Flow Ultrasonography

Paride De Rosa, Enrico Russo and Vincenzo Cerbone  
A.O.U. "OO.RR. San Giovanni di Dio e Ruggi d'Aragona, Salerno  
Italy

### 1. Introduction

The examination of blood vessels and the study of arterial districts have been already revolutionized by the introduction of B-mode ultrasonography, widely used to evaluate the blood flow. The lumen and vessel wall together with microscopic characteristics, can be clearly evidenced with this method thanks to the use of Color Doppler Flow Ultrasounds (CDFU) (Wescott 2000). This methodic is able to show the flow direction and the velocity of red blood cells as well as vascular structures. The color signals and generated angiography-like visualization of the vascular lumen surface can be shown by the integration with the Power Doppler Ultrasounds (PDU). Consequently, CDFU and PDU give not an approximate estimation but a precise measure of the residual lumen of the vessels more reliable than with conventional B-mode imaging in case of stenosis (Wescott 2000).

Recently a new technology for the detection of blood circulation has been developed by using digitally encoded sonography to boost blood echoes and to preferentially suppress non-moving tissue signals. This method is known as the B-Flow Ultrasonography (BFU) and it has higher spatial and temporal resolution than Doppler imaging because of the clearer definition of the vessel lumen (Henry 2000). BFU allows the direct visualization of blood reflectors without the limitations of Doppler technology such as aliasing, signal dropout at orthogonal detection angles and wall filter limitations. B-flow visualizes real-time hemodynamic flow in relation to stationary tissue (Jung 2007, Wachsberg 2007).

We evaluated the efficacy of BFU in examining the arterial and venous anastomoses, the cortical flow and other parameters of the graft in patients who underwent kidney transplantation for chronic renal disease.

### 2. Historical background

When color Doppler sonography was originally introduced, sinologists hoped that the new technology would provide reliable noninvasive mapping of blood flow. Although color Doppler sonography remains an essential technology for noninvasive vascular imaging, it is prone to various artifacts and limitations, resulting in some instances in which true flow is not detected and other instances where Doppler sonography falsely depicts blood flow (Middleton 1998).

The first studies about B-Flow imaging were conducted by vascular surgeon to investigate cerebral circulation in order to improve the detection of carotids stenosis. Toole and

Castaldo (Toole&Castaldo 1994) reported that a more hemodynamically disturbed flow has a greater propensity for distal cerebrovascular events. Different studies (Benefit 1998, Beneficial 1991 trials) demonstrated better outcomes in patients with symptomatic moderate (50%–69%) and highgrade (70%–99%) internal carotid arterial (ICA) stenoses (ICAS) after carotid endarterectomy, as compared with those treated medically. Even in patients with asymptomatic ICAS of 60%–99%, an absolute risk reduction of 5.9% for stroke has been reported at 5 years (ACASC Study 1995).

These studies gave rise to discussions and kindled the interest in and necessity of accurate measurement of arterial stenosis (Staikov 2000). Selective intraarterial angiography of artery is still seen as the reference standard but is an invasive method with a morbidity rate of 1%–4% that bears a 1% risk of periinterventional stroke. Color duplex flow ultrasonography (US) has become the most widely used noninvasive method of assessing arterial occlusive disease (Padayachee 1997) because it avoids the expense and risk of routine arteriography (Bell 1995). Stenotic lesions are identified and quantified by analyzing Doppler US velocity spectra in combination with real-time B-mode and color-flow images (Carpenter 1996).

Despite its broad use, several disadvantages of color duplex flow US have been described. Different studies (Carpenter 1996, Alexandrov 1997) have shown considerable variation in estimating the degree of stenosis, and even with use of similar equipment, rigid velocity criteria do not have the same validity and predictive values for grading an arterial stenoses in different laboratories. It is well recognized that duplex US results are highly dependent on the experience of the operator, which emphasizes the importance of individual evaluation and quality control for each institution (Kruskal 2004). There are also different technical limitations of US depiction of blood flow. Color duplex flow US is very sensitive to flow signals and can yield quantitative velocity and/or power information, but the price is decreased spatial resolution and frame rate, as well as high angle dependency.

Because the color duplex flow US image is presented as an overlay to the B-flow image, any large tissue motion may register as a color flash artifact that can overshadow the true flow data. Conversely, maximizing the color fill-in of vessels will almost always result in some overwriting of the vessel walls on the B-flow image, which can mask any subtle lesion in the vessel under study (GE Ultrasound Europe 1999).

### 3. B-Flow imaging

A technique for displaying flow information called B-flow imaging was introduced several years ago (Wescott 2000). This is a non-Doppler technology that directly displays flowing intravascular echoes during real-time gray-scale sonography. Flow information is derived by digitally encoding the outgoing ultrasound beam, then decoding and filtering the returning beam so as to amplify echoes generated by the particulate constituents of flowing blood.

The real-time B-flow imaging appearance of blood flow consists of mobile intravascular echoes that simulate a conventional contrast angiogram, similar to the appearance seen during infusion of a sonographic IV contrast agent. The images are particularly impressive when viewed during real-time sonography or on recorded movie clips. The technique is relatively simple to learn and operate, with fewer parameters to manipulate than color Doppler sonography. B-flow imaging was first introduced on linear transducers for vascular imaging and subsequently became available on curved transducers suitable for general abdominopelvic imaging as well.

Recent investigations have documented the value of B-flow imaging for evaluation of flow in superficial vascular structures, in particular carotid arteries and hemodialysis fistulas (Yucel 2005). B-flow imaging is a recently introduced flow technology that extends B-mode imaging capabilities to blood flow, including high frame rate and high-spatial-, high-temporal-, and high contrast-resolution imaging (Wescott 2000). It directly depicts blood echoes in a gray-scale presentation, while simultaneously depicting surrounding anatomy, but without the need for overlays. This explains the unobstructed view of the vessel lumen. These attributes of B-flow imaging promise this technique to be an important additional tool in the evaluation of arterial status. Our experience with B flow imaging has shown that in the poststenotic area, vessel stenoses produce a region of higher gray-scale intensity that we call the *jet stream*. The rationale for this jet stream seems to be that pixel brightness at B-flow imaging is determined by blood-echo strength and velocity, and both factors are influenced by the grade of vessel stenosis (Wescott 2000). However, the literature reveals scant interest in exploring abdominopelvic applications of B-flow imaging. A MEDLINE search of the English-language literature using the term "Bflow imaging" conducted on August 28, 2006, identified one preliminary report on abdominal applications of B-flow imaging published in 2003 and two investigations of B-flow imaging for evaluating fetal cardiovascular anomalies (Wachsberg 2003). In our experience, B-flow imaging is a powerful technique for noninvasive flow evaluation of the transplanted kidney. We performed this prospective pilot trial to assess the interobserver variability of different jet stream parameters and their role in the evaluation of renal stenosis. This article illustrates various advantages of B-flow imaging as a complementary technique to color Doppler sonography of the kidney vasculature.

## 4. Technical background

### 4.1 Basics

B-flow images are generated by using digitally encoded US technology consisting of a transmit encoder and a receive decoder in a digital beam former that provides electronic array focusing (Fig. 1). A small number of digitally encoded wideband pulses are transmitted into the body for each scan line. Unlike color imaging techniques, in which the typical packet size is 10–12, B-flow imaging uses a packet size as small as 2–4. Directly after receiving the reversed pulses, the decoder performs pulse-length compression ("coded excitation") on the acoustic data and then performs clutter suppression filtering. The rest of the processing is essentially the same as in conventional Bflow mode (GE Ultrasound Europe 1999).

### 4.2 Coded excitation

Coded excitation is a technique that increases the transmission energy by as much as one order of magnitude without compromising transverse resolution and is therefore especially suited for high-spatial- and high-temporal resolution imaging of echo sources that are simply weak (such as red blood cells). Through the digital encoder the scanner transmits not one, but a sequence of  $N$  wideband pulses in accordance with a specific pattern referred to as a *code*; a decoder on the receiving side is used to effectively compress the returning echo back into a single pulse that has nearly the same resolution but  $N$  times more energy (Fig. 2). If the received coded sequence and the sent code are exactly matched, the response is a

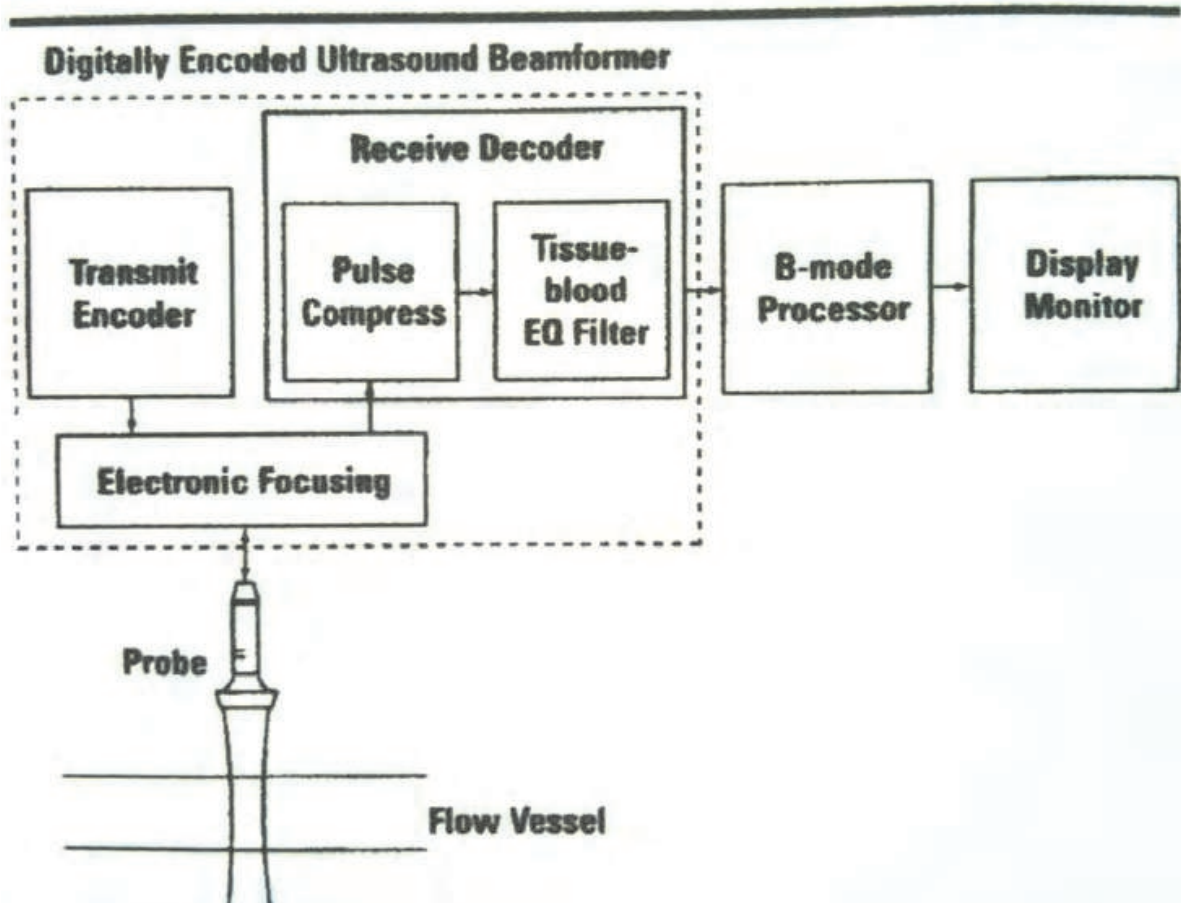

Fig. 1. Digitally Encoded Ultrasound Beamformer

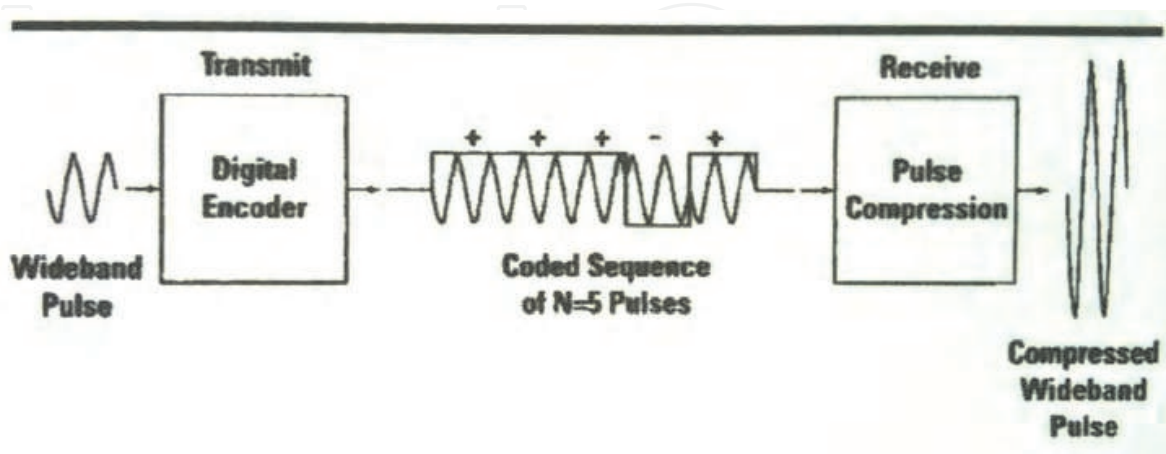

Fig. 2. Compression of wideband pulse

pulse of amplitude  $N$  times greater than a single uncoded pulse. At in vivo scanning, the returning signal represents a sum of reflections from multiple sources in body tissue, so that the output of the sum should equal the sum of outputs from individual contributing reflectors (GE Ultrasound Europe 1999).

#### 4.3 Clutter suppression filtering

For each of the coded transmissions, a stream of acoustic backscatter data from the insonated anatomy is received and coded. These data are stored in a buffer in the equalization filter, which then subtracts a fraction of the second transmission from the first transmission. This process suppresses any large and slow-moving tissue clutter component relative to any moving blood-echo component (GE Ultrasound Europe 1999).

### 5. Comparison between B-Flow Imaging and color-doppler ultrasounds

Doppler sonography uses a high-pass filter to suppress low-amplitude frequency shifts caused by physiologic movement of soft-tissue structures. Unfortunately, this filter also obliterates Doppler shifts produced by slowly flowing blood and may cause a false diagnosis of vascular occlusion. This pitfall does not apply to B-flow imaging, which excellently depicts slow blood flow. Doppler sonography is also prone to artifactual depiction of flow signals within nonvascular hypoechoic structures, whereas B-flow imaging is not plagued by such factitious flow.

The usual practice for optimizing color Doppler sonography is to increase the color gain setting as high as possible until noise develops; then lower the gain slightly to eliminate the noise (Kruskal 2004). However, this practice can exaggerate the spatial location of true flow signal, a phenomenon called "oversaturation," resulting in flow signals that are not confined to the patent lumen (Wachsberg 2003). This pitfall can cause thrombus to be overlooked or improperly characterized and can prompt a false diagnosis of vascular disease. Because of oversaturation, the spatial distribution of color signals can substantially exceed the true dimensions of a vascular structure, whereas the high spatial resolution of B-flow imaging enables excellent display of even complex vasculature. Soft-tissue vibration associated with an arteriovenous fistula, known as "perivascular color bruit," is a phenomenon that can significantly exaggerate the apparent dimensions of a vascular fistula on Doppler sonography, whereas Bflow imaging correctly displays the true dimensions. Vascular stenosis is typically diagnosed when Doppler sonography reveals a localized flow jet. However, turbulence and other factors can also cause localized acceleration of flow unassociated with anatomic narrowing. B-flow imaging is very helpful at distinguishing between a falsepositive diagnosis of vascular stenosis and a truepositive case.

Noninvasive evaluation of transjugular intrahepatic portosystemic shunts (TIPS) function with Doppler sonography is complex and fraught with pitfalls that can potentially yield misleading findings. In our experience, B-flow imaging is very helpful in supplementing the Doppler sonography TIPS evaluation. The applications illustrated in this article should not be misinterpreted as suggesting that color Doppler sonography has been or will be eclipsed by B-flow imaging. B-flow imaging does not provide information regarding flow velocity and directionality, and its current iteration has other limitations that require improvement. We anticipate that color Doppler sonography will continue to be the primary technique for noninvasive flow mapping, with B-flow imaging as a complementary technique for use in situations where color Doppler sonography findings are ambiguous or otherwise uncertain.

## 6. Our experience

### 6.1 Methods

Between June 2006 and May, 2010, 55 consecutive patients with ESRD, 37 men (67.3%) and 18 women (32.7%); mean age 47.8 (ranged between 16 to 60 years) underwent kidney transplantation from cadaveric donor. All the patients has been studied preoperatively with evaluation of principal arterial and venous axis by using Color-Power doppler. All the patients were submitted to ultrasonography check already immediately in the postoperative time . The study consisted of daily controls with a comparative evaluation of both techniques, that is Color and Power Doppler (CDFU+PDU) and B-flow imaging (BFU).

The arterial and venous anastomoses, Cortical blood flow with evaluation of R.I. (resistance index),  $V_{max}$  (blood velocity arterial peek) were examined in all patients using LOGIQ 700 ultrasound device (GE Medical Systems) with a 12 or 7 MHz probe focusing on the level around the iliac-graft anastomosis. Routine B-mode, blood flow images by PDI and B-flow were obtained and compared each other. Sequential parallel longitudinal views of flow were displayed. We closely watched vessel walls and hemodynamic flow simultaneously. In the follow-up period we submitted patients to monthly checks, focusing our attention on the detection of particular signs, such as cortical “spots” as well as defects in graft vascularization.

### 6.2 Results

In our study we observed that the analysis of parameters dropped out from an ultrasonographic study, made of the combination of standard methodics and B-flow imaging, brought to a better estimation of vascular complications after transplantation. In 25 patients (45.5%) we can assert to visualize a clearer cortical blood flow than the standard techniques (Fig. 3,4,5,6,7). Consequently the parameters of intra and extra-renal circulation resulted very easy to measure. We also noticed that in one patient occurred a reduction of blood flow through the renal artery with a sensible increase of  $V_{max}$  and R.I. (Fig. 8) during the first 24 hours after the transplantation. This conditions led to thing to an arterial stenosis but it could not certainly be included among these after CDU+PDU evaluation. In this case the B-Flow methodic enable us to characterize it as a post-operative arterial spasm (Fig. 9,10).

In this patient we didn't appreciate any reverberation both on cortical flow and on parameters of graft function. The vision of cortical vasculature by using b-flow mode allows a better In another patient we observed some cortical “spots” that coincided with a reduction of renal function in the first week after transplantation. The functional situation solved after administration of steroids but ecographic signs persists also after some months.

### 6.3 Discussion

B-flow enabled simultaneous imaging of tissue and real-time blood flow in all patients. Flow pattern was shown in gray-scale imaging. Compared with PDU, B-flow provided higher spatial resolution and frame rate hemodynamic imaging without information on velocity and direction (Volpe 2007).

Consequently, clear definition of the vessel lumen without overlay was obtained . However, resolution of vessel wall tissue was inferior to that of the conventional B-mode and PDU methods. B-flow provided clearer definition of the vessel lumen even in the renal stenosis. PDU tended to overestimate the normal vessel lumen and underestimate that of the severely stenotic portion. B-flow technology was achieved by General Electric's digitally encoded ultrasound (Park 2007).

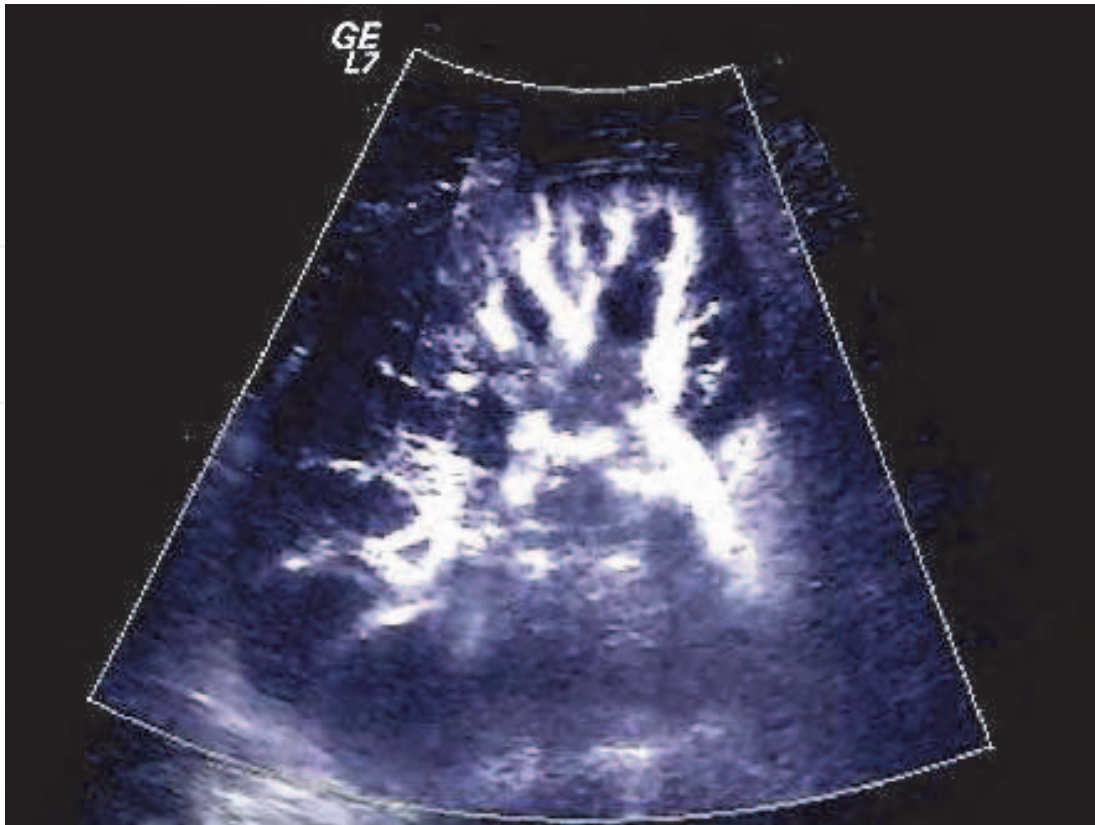

Fig. 3. B-Flow Imaging

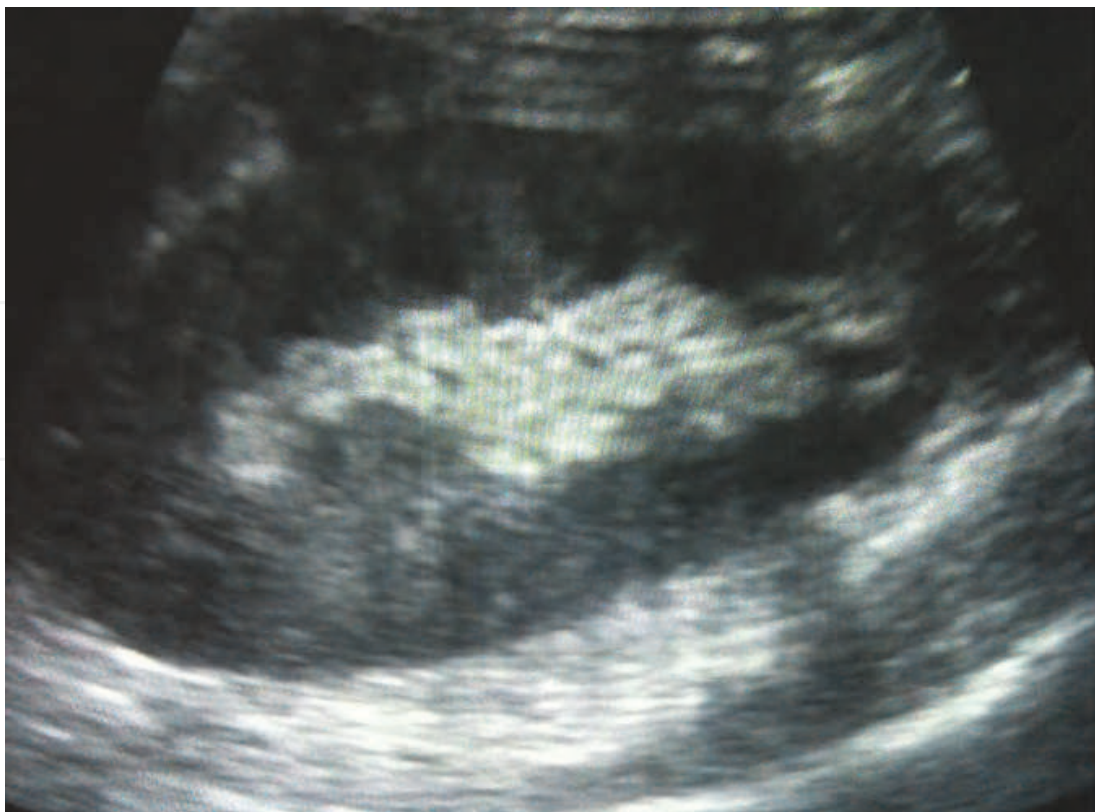

Fig. 4. B-Mode: Transplanted kidney revealed in b-mode ultrasonography



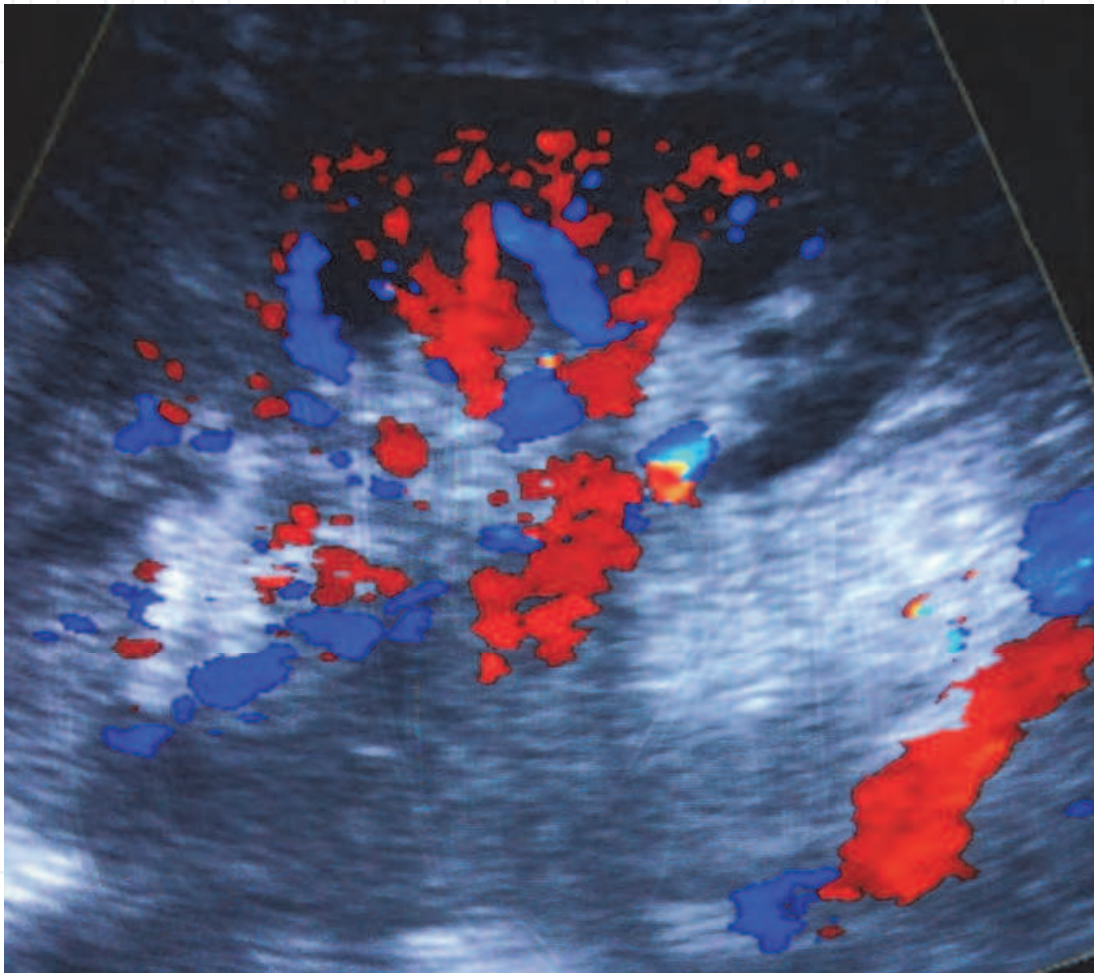

Fig. 5. The same transplanted kidney observed in classic color-power mode

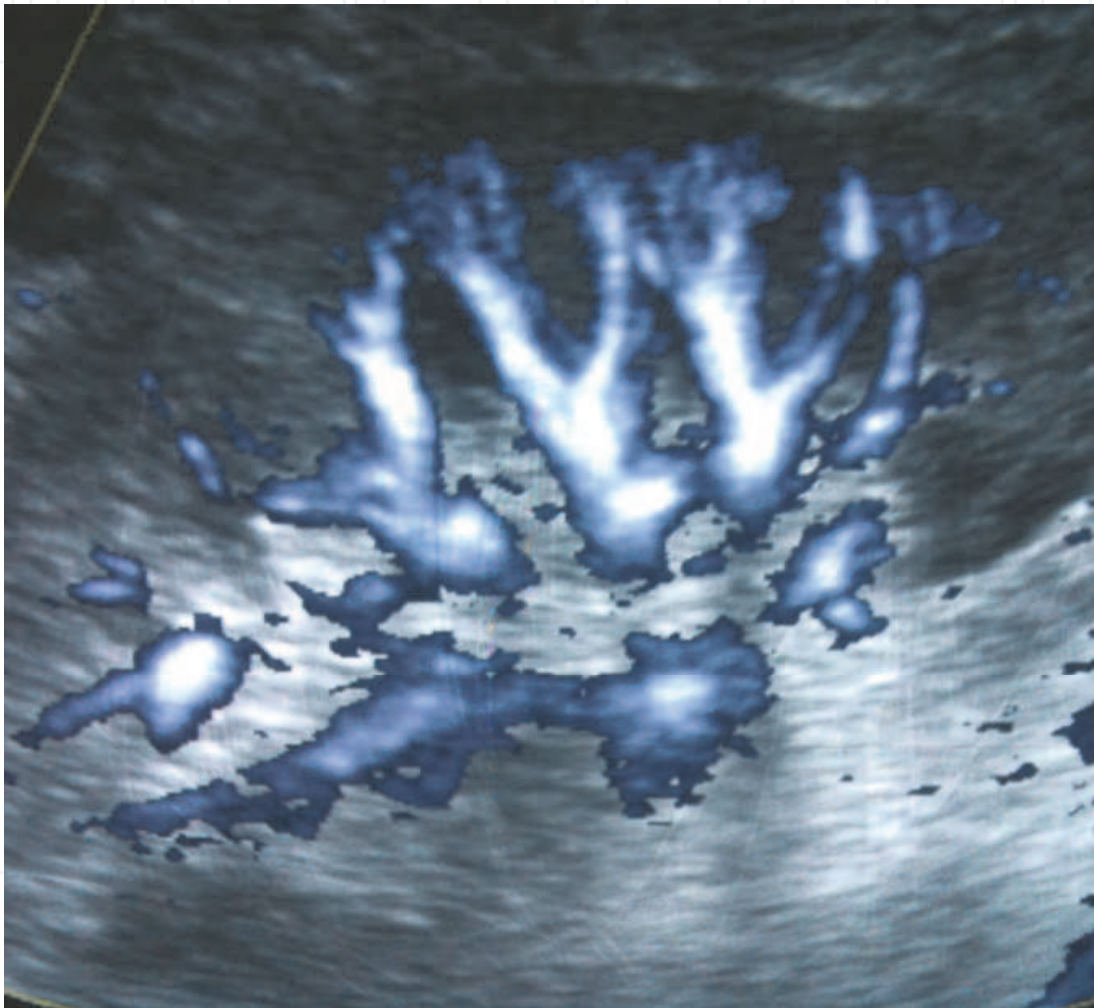

Fig. 6. B-flow vision of the precious transplanted kidney

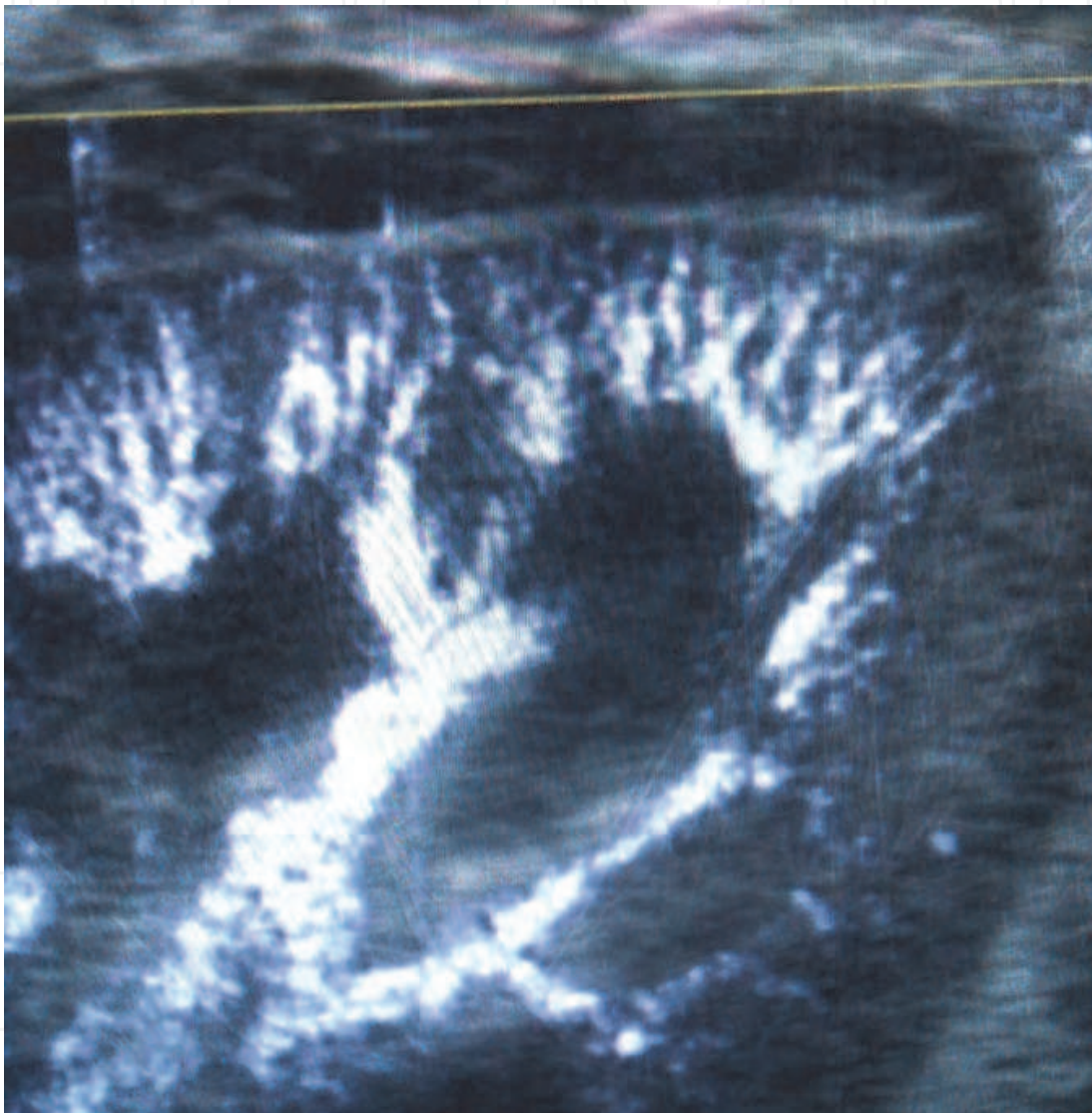

Fig. 7. Cortical vasculature: an extracapsular collection can be observed



Fig. 8. R.I (Resistance Index) measurement by using b-flow mode

Coded sound waves are transmitted into the body and vasculature, and the returning signals are then decoded and displayed, as in B-mode. This technology enables boosting of weak flow reflector signals from blood reflectors and suppresses unwanted signals and frequencies from tissue. Consequently, B-flow can visualize real-time hemodynamic flow in relation to stationary tissue. In fact, B-flow provided higher spatial resolution for demonstrations of vessel anatomy and higher frame rate hemodynamic imaging than PDU (Clevvert 2008).

This result is due to clearer definition of the vessel lumen without the overwriting seen with B-flow. In PDU, overestimation of the normal vessel lumen is caused by overwriting, and underestimation of the stenotic vessel lumen is caused by limitations in detecting flow (Buresley 2008). BFU examination does not require separate equipment and can be implemented by using the same Doppler equipment that has the necessary hardware by adding some software. BFU also has some limitations: A significant technical limitation of direct BFU measurement of renal stenosis arises in the presence of extensive plaque calcification in the iliac artery. Calcification interferes with the ability to achieve a clear sonographic window to the renal artery. In cases in which BFU measurement cannot be made because of calcification, changing the angle and position of the probe on the patient's abdomen usually can provide a sonographic window that is clear enough to measure velocities (Clevvert 2008).

Another is that sensitivity in BFU is decreased with increasing depth because of strong dependence on signal intensity strength. This limitation is especially significant in evaluation of iliac vessels, because they are more deeply rooted (Buresley 2008). Finally, the remaining two limitations are background flash and difficulty in showing slow flow. Slow flow limitation, especially in high degree stenosis, may reduce flow velocity at distal normal renal artery and may cause difficulty in imaging of lumen and measurement of diameter. It must be emphasized that B-flow provides a detailed hemodynamic image of phenomena such as bloodstream swirl. Visualization of such a complex flow pattern has not been achieved by CDFU or PDU. Our experience suggests that the use of B-flow ultrasonography may improve the identification of precocious signals of chronic allograft failure that is the finding of cortical spots (Santangelo&De Rosa 2007). Careful analysis of flow patterns at the renal anastomoses relation to the pathogenesis of ischemic graft dysfunction disease will be the subject of further study.

Doppler US velocity spectra in combination with real-time B-mode and color duplex flow images of the arteries are used to quantify stenotic lesions. Several teams have evaluated the correlation of different velocity parameters of color duplex flow US with those of angiography, proving sensitivity rates of 85%–87% and specificity rates of 89%–97%, with high interobserver correlation (Staikov 2000). Corresponding results, with excellent correlation between the results of angiography and color duplex flow US, were observed in our experience. On the other hand, clinicians caring for patients with transplanted kidney circulation problems should be aware that the duplex US criteria used for noninvasive estimation of the extent of arterial stenosis may vary considerably (Henri 2000).

Disadvantages of color duplex flow US are limited frame rate, high angle dependency, limited spatial resolution along the beam direction, and “overwriting” of the vessel walls by the color overlay (the so-called blooming artifact), which can mask subtle lesions (Park 2007).

For these reasons, we evaluated B-flow imaging in the evaluation of renal artery condition. Advantages of this recently introduced technique are simultaneous imaging of tissue and

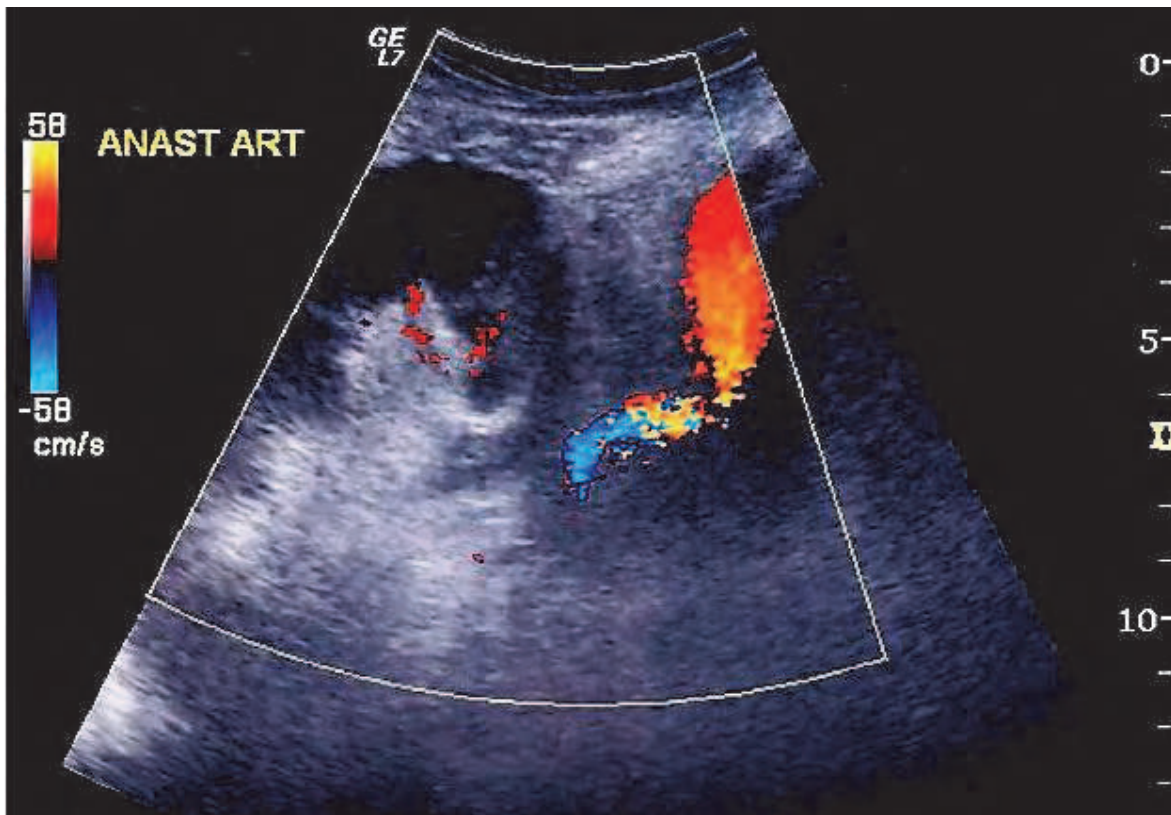

Fig. 9. Color-doppler vision of renal artery spasm

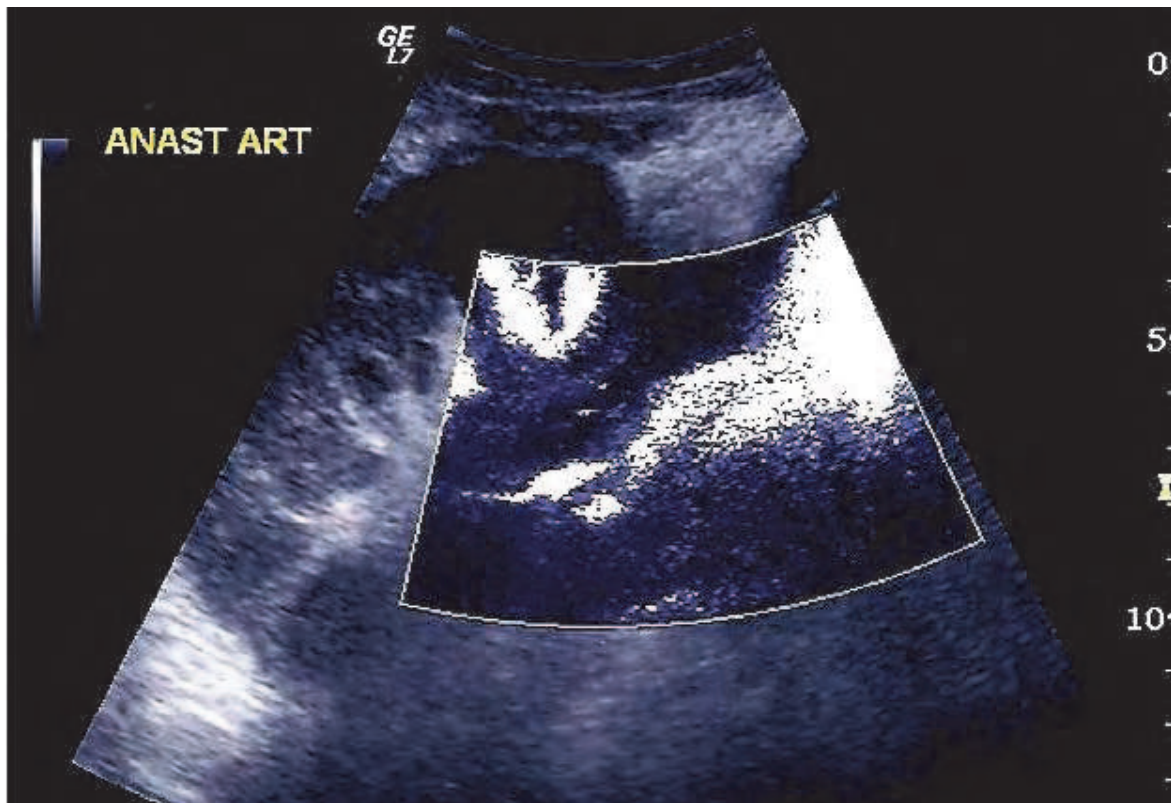

Fig. 10. The same condition in B-Flow mode

blood-echo information, so that blooming artifacts are not possible. A high frame rate is possible, as well as high spatial and transverse resolution, so that imaging of complex flow phenomena becomes possible. A further advantage is that plaque contours or intraluminal structures can be imaged in more detail, as compared with that at color duplex flow US, so there arises the possibility of qualitative description of blood flow, as well as of plaque morphology. The absence of angle dependency in B-flow imaging enables exact planimetric evaluation of the stenosis, which promises high correlation between angiography and B-flow imaging. A limitation of B-flow imaging is that excessive pulsations of the vessel lead to movement of the surrounding structures, so that the vessel wall is sometimes ill defined. Further disadvantages are an inability to obtain signals after plaque calcification (a problem with all US techniques) and decreased sensitivity of B-flow imaging with increasing depth, because of the strong dependence of signal strength (Jung 2007).

On the basis of our experience that high-grade stenosis produces a poststenotic region of higher gray-scale intensity (the jet stream) and the fact that pixel brightness or intensity, with almost no angle dependency, is determined by blood-echo strength and blood velocity (19), we evaluated B-flow imaging in the grading of transplanted kidney artery, as compared with color duplex flow US. Our study revealed no correlation between the investigated B-flow and color duplex flow US parameters. Neither the grayscale intensity nor the length and area of the jet stream yielded any hemodynamic information. Two reasons were suspected for the data mismatch but have been disproved with further statistical analysis: (a) the difficulty of clearly defining the points with maximum gray-scale intensity and the start and end points of the jet streams; however, interobserver variability was excellent (or at least almost excellent for the length of the jet stream) for all parameters; and (b) the quality of conditions for US assessment; however, no significant influence of this factor on B-flow parameters was identified. Scanning properties were fixed in all patients to exclude a possible influence on our results. The only exception concerned gain, but we calculated an additional gray-scale ratio to exclude possible bias.

As our study population correlates well with our “standard” patient population with regard to age, sex, conditions for assessment of stenosis, and color duplex flow US parameters, we believe that our results are representative, although we included only a small number of patients in the study. On the basis of these initial results, we will not use a larger patient series for the current objective.

Objectives of further clinical B-flow studies will concern the accuracy of planimetric evaluation of artery stenosis or spasm, as compared with that of angiography and plaque morphology.

## 7. Conclusion

We can say that B-flow imaging is an exciting, relatively new non-Doppler technology for noninvasive flow imaging. Our experience exploring hepatic B-flow imaging indicates that this currently underused technology has the potential to substantially improve noninvasive blood flow evaluation. As the imaging community becomes increasingly aware of abdominopelvic applications of B-flow imaging, it is hoped that manufacturers will advance the capabilities of this technology. Advantages of the method, such as angle independence, absence of blooming artifacts, and high spatial and transverse resolution, allow imaging of complex flow phenomena, as well as detailed examination of plaque morphology. Therefore, B-flow imaging has the potential to be used as an additional tool for this indication.

B-flow is highly effective in visualizing hemodynamic flow and in detecting stenotic lesions in the renal artery. Combined with conventional B-mode technique, B-flow seems to be useful in evaluating renal and anastomotic stenosis, especially in patients with vascular disease.

## 8. References

- Middleton WD. (1998). *Color Doppler: image interpretation and optimization*, *Ultrasound Q*; 14:194–208
- Weskott HP. (2000). B-flow: a new method for detecting blood flow [in German]. *Ultraschall Med*; 21:59–65
- Yucel C, Oktar SO, Erten Y, (2005). *B-flow sonographic evaluation of hemodialysis fistulas: a comparison with low- and high-pulse repetition frequency color and power Doppler sonography*, *J Ultrasound Med*; 24:1503–1508
- Goncalves LF, Espinoza J, Lee W (2005). *A new approach to fetal echocardiography: digital casts of the fetal cardiac chambers and great vessels for detection of congenital heart disease*, *J Ultrasound Med*; 24:415–424
- Kruskal JB, Newman PA, Sammons BA (2004). *Optimizing Doppler and color flow ultrasound*. *RadioGraphics*; 24:657–675
- Machi J, Sigel B, Roberts AB (1994). *Oversaturation of color may obscure small intraluminal partial occlusions in color Doppler imaging*, *J Ultrasound Med*; 13:735–741
- Wachsberg RH. (2003). *Doppler ultrasound evaluation of transjugular intrahepatic portosystemic shunt function: pitfalls and artifacts*, *Ultrasound Q*; 19:139–148
- Toole JF, Castaldo JE. (1994). *Accurate measurement of carotid stenosis*, *J Neuroimaging*; 4:222–230.
- Beneficial (1991) *effect of carotid endarterectomy in symptomatic patients with high-grade carotid stenosis*. North American Symptomatic Carotid Endarterectomy Trial Collaborators. *N Engl J Med*; 325:445–453.
- Benefit (1998) *of carotid endarterectomy in patients with symptomatic moderate or severe stenosis*. North American Symptomatic Carotid Endarterectomy Trial Collaborators. *N Engl J Med*; 339:1415–1425.
- EACAS (1995). *Endarterectomy for asymptomatic carotid artery stenosis*. Asymptomatic Carotid Atherosclerosis Study Collaborators. *JAMA*; 273:1421–1428.
- Staikov IN, Arnold M, Mattle HP. (2000). *Comparison of the ECST, CC and NASCET grading methods and ultrasound for assessing carotid stenosis*, *J Neurol*; 247:681–686.
- Padayachee TS, Cox TCS, Modaresi KB. (1997). *The measurement of internal carotid artery stenosis: comparison of duplex with digital subtraction angiography*, *Eur J Vasc Endovasc Surg*; 13:180–185.
- Bell PR. (1995). *Carotid endarterectomy: preoperative angiography is outdated (letter)*. *BMJ*; 310:1136.
- Carpenter JP, Lexa FJ, Davis JT. (1995). *Determination of sixty percent or greater carotid artery stenosis by duplex Doppler ultrasonography*, *J Vasc Surg* 1995; 22:697–703; discussion 703–705.
- Alexandrov AV, Vital D, Brodie DS. (1997). *Grading carotid stenosis with ultrasound. An interlaboratory comparison*, *Stroke*; 28:1208–1210.
- GE Ultrasound Europe. (1999). *B-Flow: a new way of visualizing blood flow – ultrasound technology update*, Solingen, Germany: GE Ultrasound Europe.



- Henri P, Tranquart F. (2000). *B-flow ultrasonographic imaging of circulating blood*, J Radiol.;81:465–467.
- Jung EM, Kubale R, Clevert DA. (2007). *B-flow and B-flow with 3D and SRI postprocessing before intervention and monitoring after stenting of the internal carotid artery*, Clin Hemorheol Microcirc.;36(1):35-46.
- Wachsberg RH. (2007). *B-flow imaging of the hepatic vasculature: correlation with color Doppler sonography*, AJR Am J Roentgenol. Jun;188(6):W522-33. Review.
- Park SB, Kim JK, Cho KS. (2007). *Complications of renal transplantation: ultrasonographic evaluation*, J Ultrasound Med. May;26(5):615-33.
- Volpe A, Caramaschi P, Marchetta A, (2008). *B-flow ultrasound in a case of giant cell arteritis*. Clin Rheumatol. Nov;26(11):1955-7. Epub 2007 Feb 17.
- Clevert DA, Jung EM, Kubale R, (2008). *Value of vascular ultrasound in the evaluation of hemodialysis fistulas*. Radiology. Mar; 48(3):272-80. Review.
- Buresley S, Samhan M, Moniri S. (2008). *Postrenal transplantation urologic complications*. Transplant Proc. Sep;40(7):2345-6.
- Santangelo M., De Rosa P., (2007). *The Finding of Vascular and Urinary Anomalies in the Harvested Kidney for Transplantation*, Transplantation Proceedings, 39, 1797–1799

IntechOpen

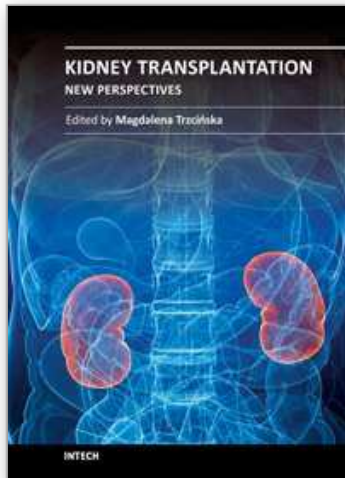

## **Kidney Transplantation - New Perspectives**

Edited by Dr Magdalena Trzcinska

ISBN 978-953-307-684-3

Hard cover, 334 pages

**Publisher** InTech

**Published online** 23, August, 2011

**Published in print edition** August, 2011

Although many years have passed since the first successful kidney transplantation, the method, although no longer considered a medical experiment, is still perceived as controversial and, as such, it triggers many emotions and that's why conscious educational efforts are still needed for kidney transplantation, for many people being the only chance for an active lifestyle and improved quality of life, to win common social acceptance and stop triggering negative connotations. Apart from transplantation controversies piling up over years transplantologists also have to face many other medical difficulties. The chapters selected for this book are of high level of content, and the fact that their authors come from many different countries, and sometimes even cultures, has facilitated a comprehensive and interesting approach to the problem of kidney transplantation. The authors cover a wide spectrum of transplant-related topics.

### **How to reference**

In order to correctly reference this scholarly work, feel free to copy and paste the following:

Paride De Rosa, Enrico Russo and Vincenzo Cerbone (2011). Post-Tx Renal Monitoring with B-Flow Ultrasonography, *Kidney Transplantation - New Perspectives*, Dr Magdalena Trzcinska (Ed.), ISBN: 978-953-307-684-3, InTech, Available from: <http://www.intechopen.com/books/kidney-transplantation-new-perspectives/post-tx-renal-monitoring-with-b-flow-ultrasonography>

**INTECH**  
open science | open minds

### **InTech Europe**

University Campus STeP Ri  
Slavka Krautzeka 83/A  
51000 Rijeka, Croatia  
Phone: +385 (51) 770 447  
Fax: +385 (51) 686 166  
[www.intechopen.com](http://www.intechopen.com)

### **InTech China**

Unit 405, Office Block, Hotel Equatorial Shanghai  
No.65, Yan An Road (West), Shanghai, 200040, China  
中国上海市延安西路65号上海国际贵都大饭店办公楼405单元  
Phone: +86-21-62489820  
Fax: +86-21-62489821

© 2011 The Author(s). Licensee IntechOpen. This chapter is distributed under the terms of the [Creative Commons Attribution-NonCommercial-ShareAlike-3.0 License](#), which permits use, distribution and reproduction for non-commercial purposes, provided the original is properly cited and derivative works building on this content are distributed under the same license.

IntechOpen

IntechOpen