

We are IntechOpen, the world's leading publisher of Open Access books Built by scientists, for scientists

4,800

Open access books available

122,000

International authors and editors

135M

Downloads

Our authors are among the

154

Countries delivered to

TOP 1%

most cited scientists

12.2%

Contributors from top 500 universities

**WEB OF SCIENCE™**Selection of our books indexed in the Book Citation Index
in Web of Science™ Core Collection (BKCI)

Interested in publishing with us? Contact book.department@intechopen.com

Numbers displayed above are based on latest data collected.

For more information visit www.intechopen.com

End-Of-Line Testing

Wolfgang Klippel
Dresden University of Technology
Germany

1. Introduction

Testing a manufactured unit at the end of the assembly line is a critical step in the production process. Defective products or even those not matching specification limits closely enough must be separated from the functional units shipped to the customer. End-of-line testing assesses not only the quality of the product, but also the stability and yield of the production process. Reliable detection of non-functional units is the primary objective of the test, but reducing the rejection rate and maximizing the output is the ultimate goal.

100% automatic testing replaces more and more subjective testing by human operators to shorten the production cycle and to improve the reproducibility and comparability of the results. However, objective measurements should provide a comprehensive assessment as sensitive as a human tester using his visual and aural senses. To fully compete with an experienced operator, the objective measurement instrument should also have learning capabilities to accumulate knowledge about physical causes of the fault. Furthermore it should be capable of being integrated in automated lines, robust in a harsh and noisy environment, cost effective and simple to use.

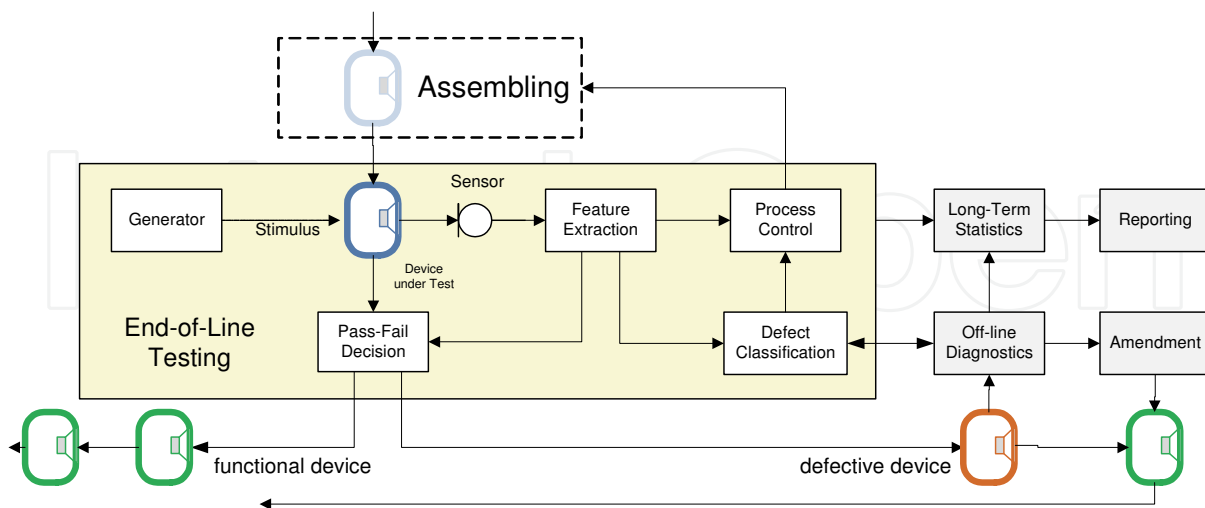

Fig. 1. Quality control at the end of the assembly line

Modern end-of-line testing (EOL) which satisfies those requirements is a complex process, as illustrated in Fig. 1. This chapter can only give a general overview on essential components, their interactions and future trends. Fig. 1 provides a roadmap of the discussion, starting with

the physical modelling of the device under test in section 2. This is the basis for ultra-fast testing, providing meaningful symptoms of the defect at high sensitivity. Important issues of the measurement will also be considered in section 3, such as the generation of a critical stimulus, the influence of the test conditions and the selection of optimal sensors. The following section 4 describes relevant features extracted by signal analysis, system identification and other kinds of transformations suppressing noise and redundant information. The Pass/Fail decision and classification of faults is the subject of section 5 and considers the problem of defining specification limits, grading the quality of the device and revealing the initial cause of the problem. The measurement results produced by end-of-line testing require a special data management and statistical analysis to support documentation, customer report and process control. The new requirements and technical possibilities in modern end-of-line testing put the future role of the human operator into question.

The discussion uses mass produced loudspeakers found in cellular phones, cars, multimedia, home entertainment and professional applications as a practical example. Some loudspeaker defects have a high impact on the perceived sound quality and will not be accepted by the customer. The loudspeaker example also represents other electrical, mechanical or acoustical systems manufactured at high quantities and low costs at a modern assembly line.

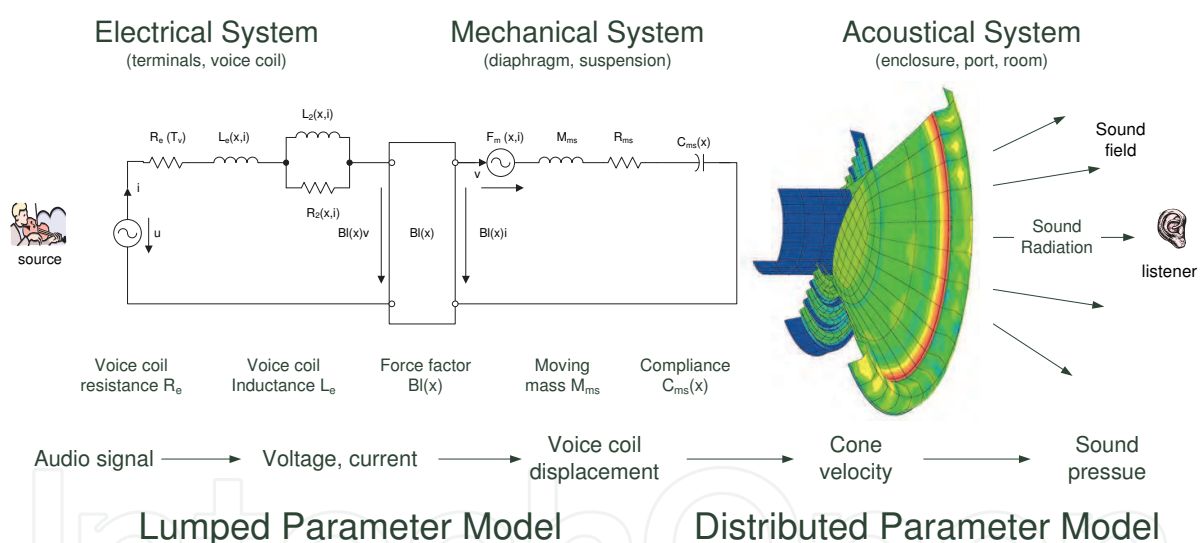

Fig. 2. Electro-dynamical loudspeakers modelled by lumped and distributed parameters

2. Physical modelling

A clear definition of the relevant properties and features of the device under test is essential for the end-of-line test to determine overall quality, perform fast measurements producing meaningful data and arrive at a correct Pass/Fail decision.

2.1 Product in the development process

The models used in the design and development process are reliable sources of this information. For example the transfer behaviour of loudspeakers can be described by two kinds of models as shown in Fig. 2.

The first model uses a small number of lumped elements representing the electrical resistance R_e , inductance L_e of the voice coil wire, force factor $Bl(x)$ – one of the most important transducer characteristics – and other mechanical parameters such as the total moving mass M_{ms} and the compliance C_{ms} of the mechanical suspension. Those lumped parameters play an important role for the quality check of loudspeakers and can be easily identified from the electrical current i , voltage u and the mechanical displacement x . A second model is used to describe the generation of mechanical modes and acoustical waves using parameters distributed over the diaphragm and the sound field. Since the velocity and sound pressure may vary from point to point, it is impossible to measure the state of all those points on the radiator's surface and in the sound field during end-of-line testing.

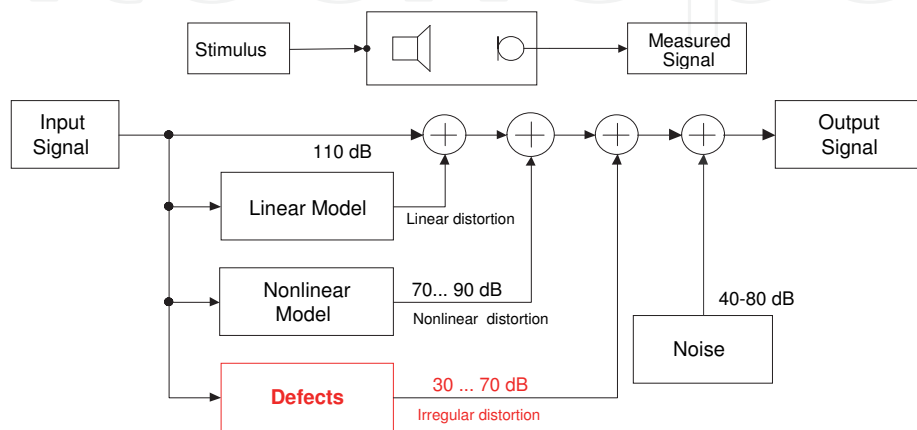

Fig. 3. Signal flow diagram showing the generation of signal distortion in a loudspeaker system

A more abstract model depicted in Fig. 3 shows the signal flow between the signal source and the sensor output, and the generation of the following distortion components in the output signal:

Linear distortions are generated by the transfer response which varies in amplitude and phase with frequency. This kind of signal distortion is independent of the amplitude of the stimulus and describes the small signal behaviour of loudspeakers. At higher amplitudes *non-linear distortions* are generated. These comprise new spectral components at multiples and combinations of the excitation frequencies. Measurement techniques assessing harmonic and intermodulation components exploit this property and play an important role in loudspeaker testing. All loudspeakers generate linear and non-linear signal distortions to a certain extent, depending on the physical limits of the electro-mechanical transducer. Those distortions are deterministic and can be predicted by numerical design tools (Klippel, 2006). The prototype at the end of the design process is a compromise between sound quality, maximal acoustical output, efficiency, size, cost and weight depending on the particular application. Those distortions are considered as regular and should be a feature of all replicated units passing the end-of-line test. Excessive signal distortions found in manufacturing are considered as *irregular distortion* and indicate a loudspeaker defect.

Ambient noise as found in a real production environment is also monitored by the test microphone and will corrupt the measurement. Those signal components differ in the sound pressure level significantly as shown in Fig. 3. Irregular distortion generated by a rubbing voice coil and other loudspeaker defects may be more than 60 dB below the total signal level and will still be detected by a human ear in the final application.

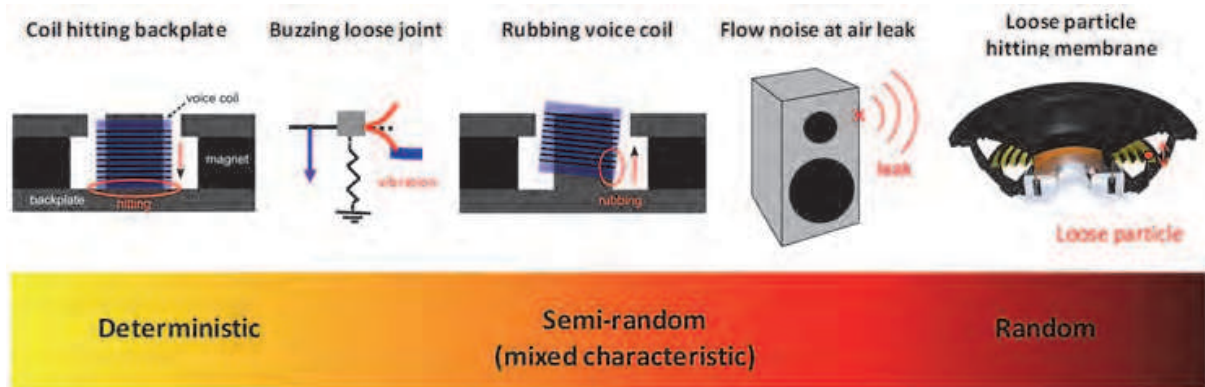

Fig. 4. Critical loudspeaker defects caused by manufacturing

2.2 Product in manufacturing

The variation in the linear and non-linear parameters provided by the physical models may be used for detecting defective units. For example, an increase of the moving mass (e.g., too much glue) or a decrease of the force factor (e.g., insufficient magnetization) reduces the sound pressure output of loudspeakers at higher frequencies. The relationship between causes and symptoms becomes more complex when initial and consecutive faults occur. For example, asymmetrical loudspeaker nonlinearities generate a dc displacement which moves the coil away from the rest position. This can cause audible distortion when the voice coil hits back-plate as shown on the left-hand side of Fig. 4. Other defects are hardly predictable, such as a poorly glued connection between the surround and the membrane behaving as an independent oscillator creating a buzzing sound. The spring-mass system performs an undesired mode of vibration at higher frequencies which is powered, triggered and synchronized by the stimulus. The faulty glue joint behaves here as a nonlinear switch activating the resonator above a critical amplitude. The beating of the braid wire on the loudspeaker diaphragm is a similar defect generating impulses at a particular position of the voice coil. The energy of those impulsive distortions is usually small and does not grow significantly with the level of the stimulus. A coil rubbing at the pole tips is a typical fault found in the production of loudspeakers generating impulsive distortion which contains deterministic and random components (Klippel, 2003). Air leaks in dust caps or in sealed enclosures emit a small air flow driven by the ac sound pressure inside the box which generates air turbulences and random noise (Klippel, 2010). Some loudspeakers defects behave randomly. For example, dust in the magnetic gap or below the dust cap in loudspeakers are accelerated by the cone displacement and hit the diaphragm at unpredictable times.

Although some irregular loudspeaker defects produce symptoms which are not predictable and cannot be modelled completely, it is still beneficial to investigate the physics of those defects and to develop sensitive measurement techniques exploiting particular features of those symptoms. Fig. 5 illustrates this approach using the example of air noise generated by a small leak at the rear of a loudspeaker enclosure. The random noise is generated by turbulences due to the high velocity of the air at the exit of the leak. However, the air volume velocity $q(t)$ is not constant, but a function of the sound pressure $p_{\text{box}}(t)$ in the enclosure and the voice coil displacement $x(t)$. The flow diagram on the right-hand side describes the generation by using a linear system $H_{\text{pre}}(j\omega)$ generating the sound pressure signal p_{box} , a nonlinear modulation process and a second linear system $H_{\text{post}}(j\omega)$ describing

the propagation of the generated noise to any point r_a in the sound field. Information from the physical modelling provides the basis for a new demodulation technique for detecting air leaks more sensitive and reliable than the human ear.

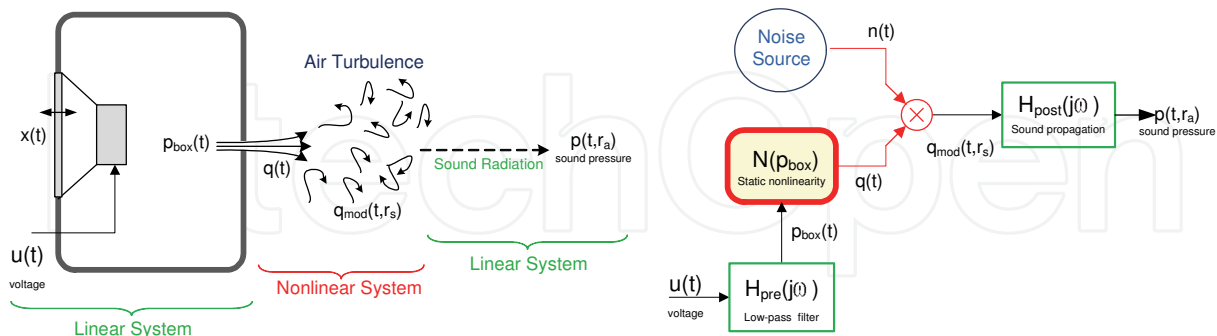

Fig. 5. Generation of turbulent air noise by a leaky loudspeaker enclosure

3. Measurement

This chapter discusses the theoretical and practical aspects of performing the basic measurements, considering the measurement condition, excitation of the device under test and using optimal sensors to monitor relevant state variables.

As expected from any other measurement process, the results of end-of-line testing should be repeatable under the same conditions, reproducible by a different operator at a different location using the same instrument, stable over time and free of bias. Repeatability and reproducibility can be tested by a gauge R&R test which reveals undefined factors that increase the variability of the measurement process. For example, loudspeaker transducers have to be clamped in the same way and at the same distance from the microphone, and should not be varied from measurement to measurement. The stability over time may be affected by climate conditions such as temperature, humidity and static sound pressure which affect the speed of sound. A critical issue in end-of-line testing is the accuracy of the measurement process producing bias-free results which agree with the "true" values and are comparable with the results of other instruments. The sound field generated by loudspeakers, for example, is influenced by the properties of the acoustical environment such as waves reflected from the table, floor, ceiling and room modes. Measurements performed in an anechoic room which are indispensable in loudspeaker design are usually not practical and too expensive in manufacturing. Measurement in a normal production environment using a simple test box is preferred but requires a special calibration routine to ensure comparability with the results of measurements in research and development (R&D). Instead of assessing absolute characteristics which might be easily a subject of a bias, it is more practical to use relative characteristics in end-of-line testing for defining the quality of the device under test. This subject will be discussed in the next chapter in greater detail.

3.1 Test environment

Fig. 6 shows a simple and cost-effective hardware setup which complies with the requirements in the manufacturing of woofers, tweeters and other transducers used in audio systems. It comprises a front-end generating the stimulus, microphones, a power amplifier, a PC for processing the data and auxiliaries integrating the instrument into the production

line. The loudspeaker is clamped at a clearly defined position on a rigid test box unable to perform any parasitic vibrations. The microphone measures the sound pressure in the near field of the transducer at a fixed (local) position. The test box also provides some shielding against ambient noise generated in a real production environment. However, the enclosed air volume in the test box behaves as an additional air spring which reduces the displacement of the voice coil at lower frequencies. Although the interior of the loudspeaker box is damped by lining the inner walls with absorbing materials, the radiated sound pressure output is also affected by standing waves. Thus the acoustical measurements performed in the test box are only accurate for the particular measurement setup used at the end of the assembly line and are not directly comparable with the absolute measurements made under other measurement conditions during the design process. This discrepancy has an important consequence on defining permissible limit thresholds in the Pass/Fail detection discussed below.

The measurement setup shown in Fig. 6 uses additional sensors to monitor production noise, air temperature and humidity. This information is crucial for detecting invalid measurements corrupted by ambient noise and to ensure long-term stability under varying climate conditions.

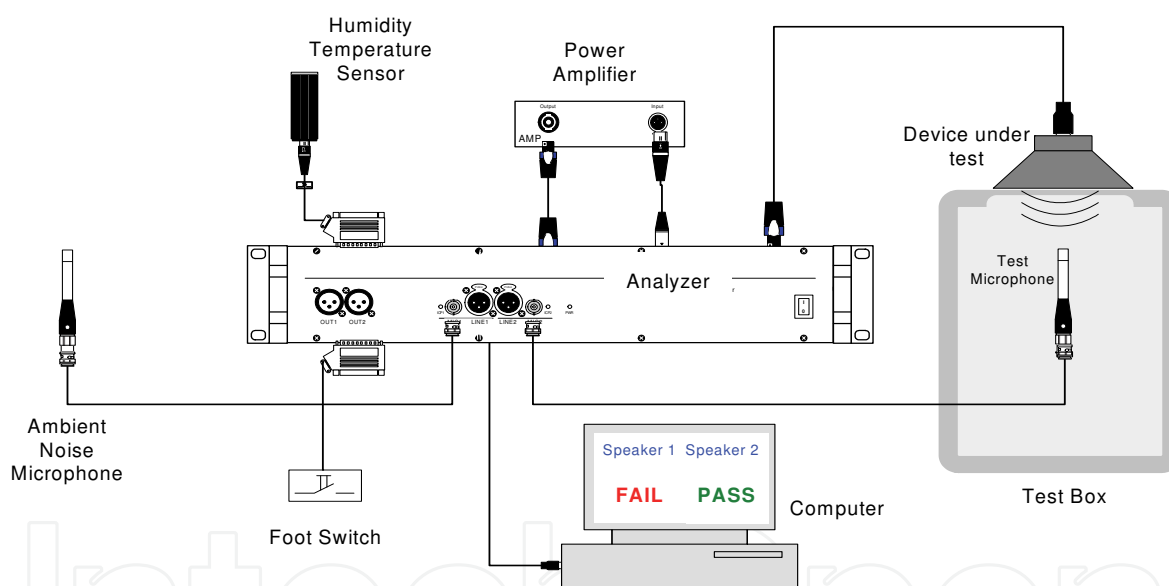

Fig. 6. Typical hardware setup for the end-of-line testing of loudspeakers

3.2 Stimulus and excitation

Most defects only produce significant symptoms if the device under test is operated in a critical state. An optimal excitation requires sufficient energy (e.g., ac main power) or a particular stimulus (e.g., analogue or digital signal). Ensuring sufficient excitation within the shortest time possible leads to ultra-fast testing which will be discussed in greater detail:

Loudspeakers are passive systems which require an electrical AC signal to produce an acoustical output. A sinusoidal stimulus excites the device at only one defined frequency and generates the fundamental component. All other frequency components found in the output spectrum can be identified as non-linear signal distortion or measurement noise. This measurement has to be applied to other frequencies within the audio band of interest

(e.g., 20 Hz to 20 kHz) by stepping the frequency over discrete points with sufficient resolution (e.g., $1/10^{\text{th}}$ of an octave) or by using a sinusoidal chirp sweeping continuously over all frequencies. The *stepped sine* stimulus stays at each frequency for a fixed number of periods (usually 5) to generate steady-state condition and to separate pre- and post-ringing after changing the frequency. Fig. 7 shows that the stepped sine stimulus spends most of the measurement time at low frequencies where the period length is long and both devices under the test and measurement instrument need a longer settling time. A complete measurement according to the minimal requirement can be accomplished within 1.5 s. Speeding up the measurement by reducing the number of test tones is not possible because the poor frequency resolution jeopardizes the excitation of loudspeaker defects behaving as narrow band resonators (e.g., buzzing parts not glued properly).

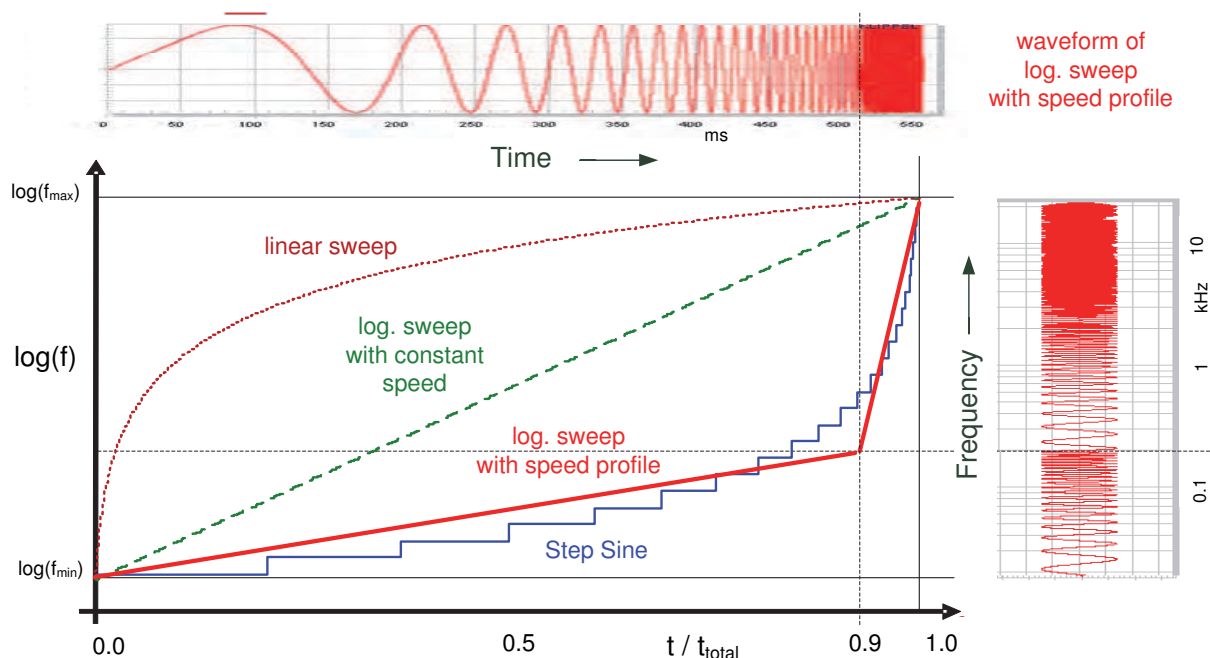

Fig. 7. Sinusoidal stimuli for measuring the transfer behaviour of loudspeakers

Continuous sweeps excite all frequencies using a defined mapping between instantaneous frequency and measurement time. The *linear sweep* passes the low frequencies quickly and spends most of the time at higher frequencies. The measurement time should be about 20 s to provide sufficient resolution at low frequencies according to minimal requirements. The *logarithmic sweep* with a corresponding frequency-time mapping reduces the measurement time at higher frequencies for the benefit of lower frequencies accomplishing the measurement within 0.4 s. However, the measurement time can be reduced even further to 0.2 s by using a *sinusoidal sweep with speed profile* as illustrated in Fig. 7. This stimulus comprises logarithmic sections with different sweep speeds and approximates the preferred frequency-time mapping of the stepped sine stimulus. It spends 90% of the measurement time below 200 Hz to activate all kinds of irregular loudspeaker defects and passes the high frequency range at a 10 times higher sweep speed.

Although the sinusoidal sweep with speed profile is a convenient stimulus for ultra-fast testing of audio equipment and other electronic devices, it cannot assess the

intermodulation distortion generated by non-linearities in the device under test. A sparse multi-tone signal comprising a multitude of distinct tones at a defined spectral distance and pseudo-random phase produces a noise-like stimulus which has properties similar to a steady-state audio signal, generating all kinds of harmonic and intermodulation distortion components in the output signal. This stimulus is ideal for assessing the large signal performance of loudspeakers and to identify motor and suspension non-linearities.

Music, speech and other natural audio signals play an important role in systematic listening tests during the design phase but play a minor role in stimulating devices during end-of-line testing because those tests are inferior with respect to sensitivity and speed.

3.3 Sensor system

Monitoring relevant state variables of the device under test is a further requirement for achieving high sensitivity in end-of-line testing. This question is closely related to the selection of optimal sensors and can be answered by using information from physical modelling as discussed in section 2. For example, the state of a loudspeaker can be observed in the electrical, mechanical or acoustical domain.

The acoustical measurement is indispensable for detecting air leakage noise and other impulsive distortion generated in the mechanical and acoustical domains which also have a high impact on the perceived sound quality. However, the sound pressure signal is less suited for assessing the properties of the electrical and mechanical system modelled by lumped parameters as shown in Fig. 2. A simple measurement of the electrical signals at the loudspeaker terminals provides results which are more reliable and easier to interpret. The direct measurement of mechanical state variables by scanning techniques is important for assessing the cone vibration during the design process, but until now has played a minor role in end-of-line testing. However, inexpensive triangulation lasers are already being used for testing spiders, passive radiators, diaphragm and other mechanical loudspeaker parts on the assembly line.

Multiple sensors combined into an array (e.g., microphone array) and parallel acquisition of the sensor output signals are required to localize the position of the defect in a sound field or a mechanical structure corresponding with a distributed parameter model. The number of sensors and locations in a sensor array depends on wavelength of the signal components and the distance to the source. The position of defects generating deterministic symptoms can also be determined by repeating the measurements while changing the position of the sensor.

4. Feature extraction

The objective of signal analysis is to extract features from the monitored signals which reveal the symptoms of the defect, to remove redundancy in the data and to suppress information not relevant for the quality assessment. This section can only give a short overview on plurality of traditional and new methods used for end-of-line testing.

4.1 Signal analysis

The first class of methods as summarized in Table 1 are applied to the time signals at the sensor outputs. There are no assumptions made as to how the device under test is excited and what properties the stimulus has. There is also no physical model of the device required. Thus the signal analysis is the most general approach which can be applied to all kinds of devices under test.

Signal Characteristics	Measurement technique and diagnostic value
Rms value	corresponds to the power of the signal (e.g., SPL) and is a simple and sensitive characteristic for detecting defects generated by deterministic processes (e.g., variation of loudspeaker sensitivity).
Peak value	is the maximal absolute value of the time signal within a time frame such as a period. This characteristic is good for assessing impulsive distortions which have a low rms value (e.g., loose particles).
Crest factor	is the ratio between peak and rms value and describes the impulsiveness of the signal independent of the magnitude of the signal (a crest factor > 10 dB indicates an irregular defect in loudspeakers).
Autocorrelation function $\psi(\tau)$	describes the correlation of a time signal $x(t)$ with itself $x(t-\tau)$ using a lag τ and gives information about repeating events (e.g., periodicity, pitch).
Coherence	describes the relationship between two signals using the cross-correlation spectrum normalized by the auto correlation of the two signals. This characteristic can be used for detecting an invalid measurement corrupted by an ambient noise source using a multi-sensor system (Bendat & Piersol, 1980).
Periodicity	can be assessed by the crest factor of the autocorrelation function $\psi(\tau)$ of the signal for $\tau \neq 0$. A high value indicates a repetitive process (e.g., sound emitted by electrical motor).
Period length T	is the time difference between adjacent maxima in the autocorrelation function corresponding with the lowest frequency component generated by a deterministic process (e.g., revolution of a car engine).
Synchronous average	is the mean value of adjacent sections of a repetitive time signal with the period length T and reveals the deterministic periodical component while attenuating all random and non-periodical components (e.g., ambient noise).
Random residual	is the difference between the original time signal and the synchronous average and reveals random and non-periodical components (e.g., loose particles, air leakage noise, external disturbances of production noise) in the time domain (Klippel, 2010).
Cepstrum	is the inverse Fourier transform of a logarithmic spectrum (Oppenheim & Schaffer, 2004) which is useful for the deconvolution of source signal (e.g., engine noise) and the impulse response describing the propagation of the signal (e.g., radiation by the car body).
Signal Envelope	is the magnitude of the analytical signal calculated by using the Hilbert transform or by performing a demodulation of the signal which is useful for detecting defects generated by a semi-random process such as modulated air leakage noise (Klippel, 2010).
Discrete Fourier Transform (DFT)	provides a line spectrum of a time sequence which is assumed to be periodical. This transform is preferred for synchronous analysis of periodical signals where the length of the DFT corresponds to multiples of the period length T of the signal (e.g., hard bottoming of the voice coil at the pole plate).
Short-time Fourier Transform (STFT)	is a frequency-time analysis applying windowing to the waveform prior to a discrete Fourier transform. The transform is preferred for non-stationary signals where either a high frequency or a high temporal resolution is required (Boashash, 2003).
Discrete Wavelet Transform (DWT)	is a frequency-time analysis using wavelets with a temporal length scaled according to the analyzed frequency band. This transform is preferred for non-stationary signals where a high frequency resolution at low frequencies and high temporal resolution at high frequencies is required (Percival & Walden, 2000).

Table 1. Important characteristics provided by signal analysis

The applications of the signal analysis techniques will be illustrated on a sound pressure signal measured in the far field of a loudspeaker system having a small air leak. The diagram on the left-hand side of Fig. 8 shows the signal waveforms radiated by the defective loudspeaker as a solid line and the waveform of the same loudspeaker where the leak is sealed as dashed line.

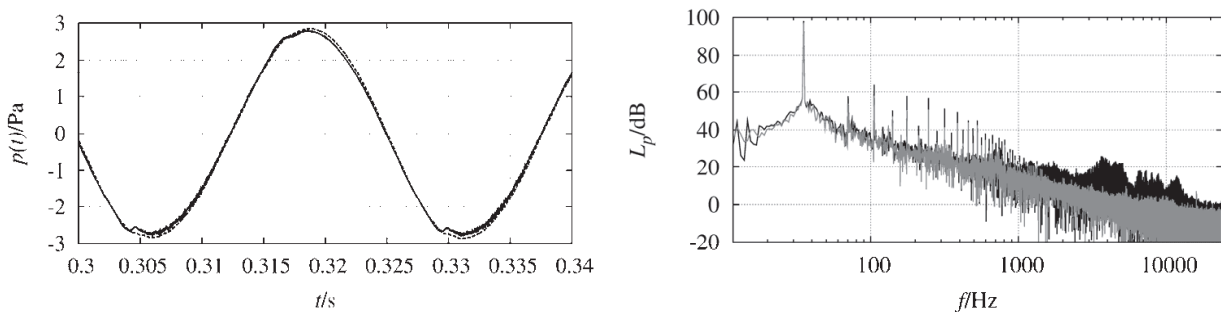

Fig. 8. Waveform (left) and spectrum (right) of the sound pressure signal measured at a leaky enclosure (solid black lines) and a sealed enclosure (dashed grey line) using a sinusoidal stimulus at 35 Hz

The loudspeaker without leak generates a smoother waveform but there is neither significant difference in the peak nor in the rms value. The autocorrelation function calculated from both signals reveals high periodicity and a period length of 28.5 ms. The discrete Fourier transform (DFT) applied to the both time signals which are exactly 128 periods long provides the line spectra shown in the right hand side of Fig. 8. There are distinct spectral components at $f_0=35$ Hz and at multiple frequencies $f_n=nf_0$ with $1<n<20$ with almost the same sound pressure level (SPL) for the functional and defective unit shown as black and grey lines, respectively. The air leak generates a higher sound pressure level for spectral components above 1 kHz. The power of the symptom is very low (-80 dB) and distributed over a wide frequency range causing a low spectral power density close to the noise floor of the measurement system. Therefore it may be more beneficial to attenuate the low frequency component below 1 kHz and to transform the high frequency component back to the time domain by using an inverse DFT. This corresponds to high-pass filtering of the original sound pressure signal revealing useful symptoms of the air leak.

4.2 System analysis

Many devices under test (such as loudspeakers) can be considered as transfer systems requiring an input signal for excitation and generating an output signal closely related to the stimulus, but containing additional signal distortion as shown in Fig. 3. Using a particular test signal with particular properties, the monitored sensor signal can be split into linear, nonlinear and irregular distortion components, providing further characteristics for end-of-line testing as summarized in Table 2.

Exploiting the properties of the stimulus, the spectral components found in the signal analysis may be interpreted as fundamental or distortion components. The sound pressure signal of the loudspeaker with and without air leak in Fig. 8 has been excited by a sinusoidal test tone at $f_0=35$ Hz. Thus the lowest frequency component found at this frequency is the fundamental component which dominates the total sound pressure signal. The phase of the fundamental component reveals polarity of the loudspeaker and may be used for checking

System Characteristic	Measurement technique and diagnostic value
Amplitude Response of the Fundamental Component	corresponds at small amplitudes with the magnitude of the linear transfer function and reveals failures in the small signal performance (e.g., variation of the cone mass).
Phase Response of the Fundamental Component	corresponds at small amplitudes to the phase of the linear transfer function and is important for checking time delay (e.g., microphone distance) and polarity.
Total harmonic distortion (THD)	describes the rms value of all harmonic components which are multiples of the excitation frequency. It reveals the dominant nonlinearities (e.g., nonlinear stiffness of the mechanical suspension in loudspeakers).
Total harmonic distortion and noise (THD+N)	describes the rms value of all signal components without fundamental component. It reveals the dominant nonlinearities and other disturbances which are not at multiples of the fundamental frequency (e.g., humming component at 50 Hz asynchronous to the excitation signal).
2 nd -order harmonic distortion	indicates an asymmetrical shape of the nonlinearity inherent in the system (e.g., a different stiffness of the mechanical suspension for positive and negative displacement).
3 rd -order harmonic distortion	indicates a symmetrical shape of the nonlinearity (e.g., symmetrical limiting of the mechanical suspension).
Peak-value of higher-order distortion	measured by using a sinusoidal stimulus of frequency f_0 , high-pass filtering of the sensor signal at a cut-off frequency $f_c > 10f_0$ and detecting the peak value within a period $1/f_0$ in the time domain (Irrgang, 2006). This characteristic is sensitive for all kinds of impulsive distortion generated by a random or deterministic process (e.g., voice coil rubbing).
Peak value of higher-order harmonic distortion	measured by using a sinusoidal stimulus of frequency f_0 , detecting the peak value within a period $1/f_0$ in the sensor time signal comprising only n th-order harmonics with $n > 10$ (Klippel, 2003). This characteristic reveals the impulsive distortion generated by a deterministic process (e.g., hitting the back plate).
Peak value of higher-order non-harmonic distortion	measured by using a sinusoidal stimulus of frequency f_0 , filtering of the sensor signal to select only non-harmonic components above a cut-off frequency $f_c > 10f_0$ and detecting the peak value within a period $1/f_0$ in the time domain (Klippel, 2011). This characteristic reveals the impulsive distortion generated by a random process (e.g., loose particles).
Peak value in the envelope of non-harmonic distortion	measured by using a sinusoidal stimulus of frequency f_0 , filtering of the sensor signal to select only non-harmonic components above a cut-off frequency $f_c > 10f_0$ and reading the peak value in the envelope of the demodulated signal averaged over multiple periods Klippel, 2011). This characteristic reveals semi-random processes having a random fine structure but a deterministic envelope (e.g., air leakage noise).
Multi-tone distortion	measured by using a sparse multi-tone stimulus and selecting the distortion components in the sensor signal found at frequencies not excited by the stimulus (Cabot, 1999). This measurement reveals harmonic and intermodulation distortion and is very sensitive for detecting a force factor nonlinearity (e.g., caused by voice coil offset).
Incoherence	describes the deviation from a linear relationship between the input and output signal (complement to coherence). This characteristic may be applied to music, speech and other arbitrary stimuli having a dense spectrum and reflects all kinds of nonlinear signal distortion and noise.

Table 2. Characteristics provided by generic methods of system analysis

the correct connection of the electrical terminals. The spectral components at multiple frequencies $f_n = nf_0$ with $n \geq 2$ are the n th-order harmonic distortion components generated by the nonlinearities inherent in the device under test. The energetic summation of those components gives the total harmonic distortion THD. The symptoms of the air leak are not only higher-order harmonics ($n > 20$) but also spectral components at other frequencies. Repeating the signal analysis for other excitation frequencies leads to the frequency response of those components.

Fig. 9 shows the frequency responses of the SPL fundamental, 2nd-5th harmonics and the total harmonic distortion in the sound pressure output using a short logarithmic sweep with speed profile as shown in Fig. 7. The roll-off of the fundamental component at the cut-off 100 Hz limits the usable audio band at lower frequencies, while the break-up modes cause the peaks and dips at higher frequencies. The motor and suspension nonlinearities cause a high value of THD at low frequencies. The higher-order distortions curve is 45-60 dB below the fundamental and shows that the device under test has no impulsive distortion generated by a rubbing coil or other irregular defects.

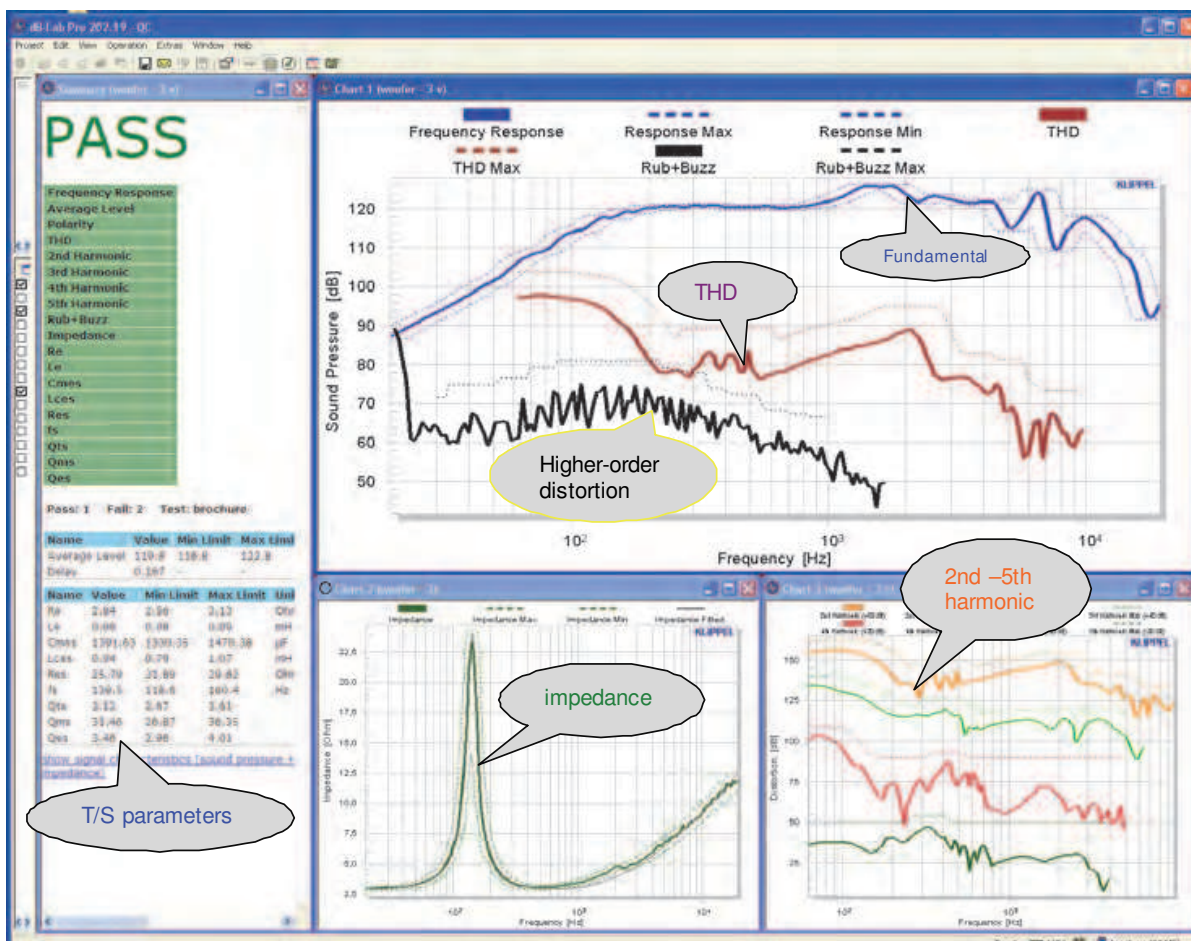

Fig. 9. Results of ultra-fast loudspeaker testing using a 200 ms stimulus

To increase the sensitivity of the end-of-line measurement and to identify the physical cause of the defect further features have to be derived from the measured signals. Synchronous averaging over adjacent periods provides the deterministic component at a higher signal-to-noise ratio while suppressing measurement noise and other random components. This can

also be realized by a comb filter selecting all harmonic components in the high-pass filtered signal as shown in Fig. 10. The complementary signal comprising only non-harmonic components is a random signal.

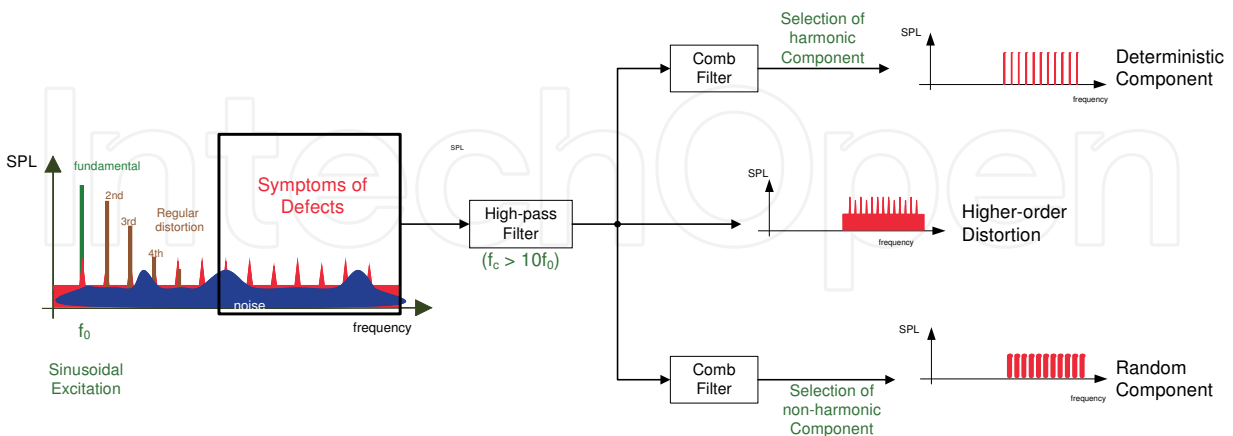

Fig. 10. Separation of the deterministic and random distortion components using a sinusoidal stimulus

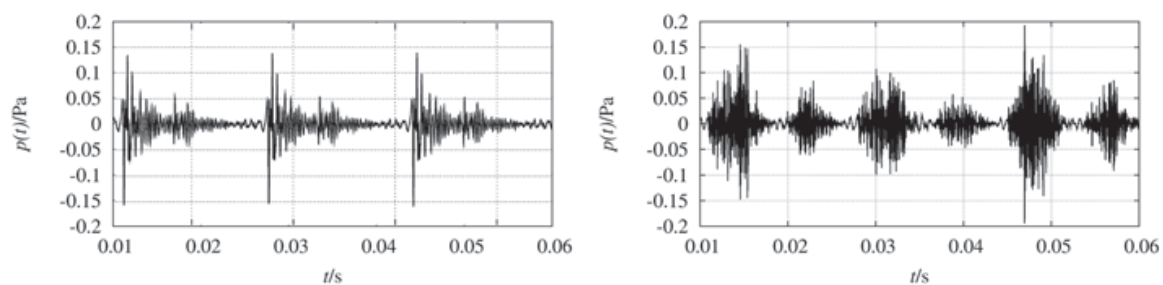

Fig. 11. Waveform of deterministic distortion component (left) caused by a buzzing loose joint and random distortion component (right) generated by an air leak

Fig. 11 illustrates the benefit of this separation on a loudspeaker having two defects. The periodic waveform in the left diagram reveals a deterministic defect caused by a buzzing loose joint while the random component on the right side is caused by an air leak in the enclosure. Turbulent noise generated at the leak has a completely random fine structure, but the envelope of the noise is deterministic due to the modulation process discussed in Fig. 5. Since the amplitude of air leakage noise is very small and in the same order as

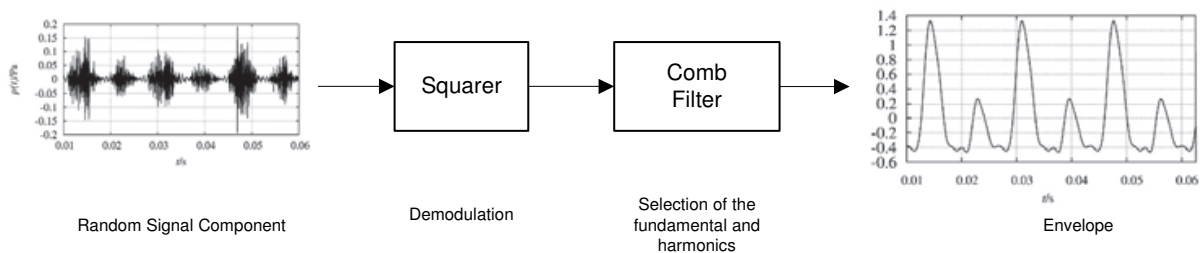

Fig. 12. Detection of turbulent noise generated by air leaks by demodulating the random signal component and synchronous averaging of the envelope

ambient noise (e.g., air conditioning) a measurement technique which accumulates the energy over time is required. Direct averaging of random distortion signals over multiple periods will reduce the noise signal and reveal no meaningful symptoms. Demodulation of the random distortion signal and synchronous averaging of the envelope as shown in Fig. 12 provides a sensitive feature for detecting semi-random noise reliably (Klippel & Werner, 2010).

4.3 Model identification

Exploiting available a-priori information on the physics of the device under test provides further features for end-of-line testing. These are more closely related to the material and geometrical properties of the device. Table 3 gives an overview on those characteristics:

Characteristic	Measurement technique and diagnostic value
Parameters	of the model are identified by reducing a cost function assessing the difference between estimated and measured signals. The estimated parameters describe the particular device under test and are independent of the stimulus used. The parameters have a physical meaning (e.g., force factor) and correspond to material parameters and geometrical variation (e.g., voice coil offset in mm) and can be used for process control.
State variables	can be calculated for the particular stimulus by using the model and identified parameters. This is beneficial for assessing state variables (e.g., voice coil displacement) which cannot be monitored at the end of line or require an expensive sensor (e.g., laser) otherwise.
Signal Distortion	can be calculated for the particular stimulus by using the identified model giving access to the linear and nonlinear signal components. This technique allows separating regular distortion found in functional units from irregular distortion generating by defects (loose particles).
Variables with reduced variance	are calculated from the original variables (e.g., resonance frequency) by compensating temperature, humidity and other external factors. This compensation of the climatic influence requires, for example, thermometer and other sensors at the assembly line and a model for predicting the behavior at defined condition. This reduces the common-cause variance in the measured variables and allows application of tighter specification limits.

Table 3. System identification techniques used for end-of-line testing

Linear system identification has a long history in loudspeaker measurement and can be realized by fitting the predicted electrical impedance based on the lumped parameter model in Fig. 2 to the measured impedance response. The best estimate of the free model parameters are the Thiele/Small parameters (T/S) are shown on the lower left hand-side of the screenshot Fig. 9. Those parameters include the voice coil resistance, resonance frequency and Q factor and are easy to interpret. However, the linear model is limited to the small signal domain and cannot explain the generation of nonlinear distortion at higher frequencies. Nonlinear system identification exploiting the nonlinear distortion measured in voltage and current at the loudspeaker terminals reveals the loudspeaker nonlinearities in the motor and suspension system. For example, an offset in the voice coil rest position can be detected in the asymmetry (e.g., shift to the right sight) of the bell shaped force factor characteristic as illustrated in Fig. 13.

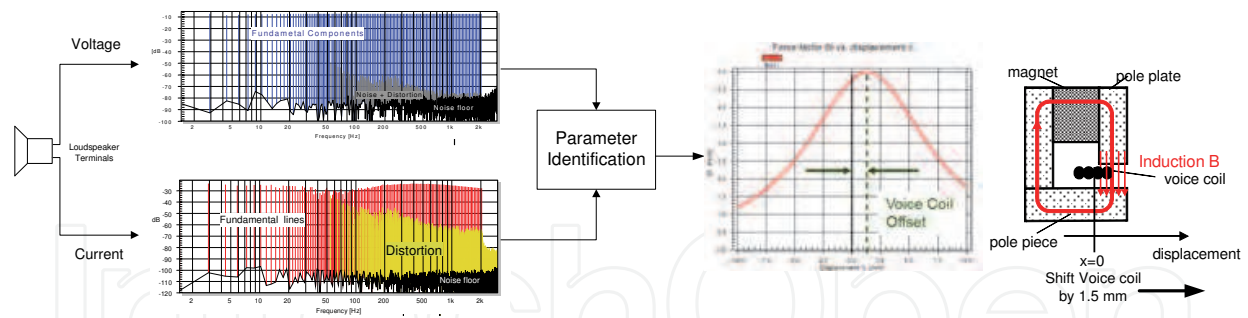

Fig. 13. Measurement of the voice coil offset in mm by identifying the force factor nonlinearity based on voltage and current monitoring at the loudspeaker terminals

A model with identified parameters also provides the state variables (e.g., displacement, voice coil temperature) for an arbitrary stimulus and dispenses with an additional sensor (e.g., laser). System identification can also be used for the measurement of irregular distortions (e.g., caused by a small loose particle) which are masked by regular distortion (e.g., caused by motor and suspension) and not detectable by a human ear or conventional signal and system analysis. Such a defective unit cannot be shipped to the customer because the defect may become worse in the final application (e.g., particle causes voice coil rubbing) eventually generating audible distortion. An adaptive model is used to learn the deterministic properties of the functional devices and synthesize the regular distortion which is subtracted from the measured signal as shown in Fig. 14. Such an active compensation (Irrgang, 2006) increases the sensitivity for irregular distortion by 10 – 30 dB and belongs to the technologies which outperform the capabilities of a human tester.

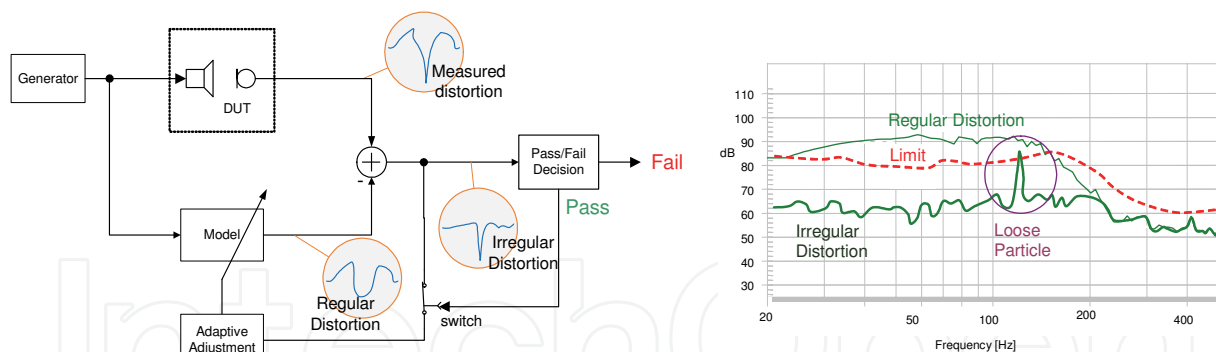

Fig. 14. Active compensation of deterministic properties found in all functional devices under test to increase the sensitivity of the measurement system for defects masked by regular distortion

4.4 Feature reduction

The previous discussion focused on analysis techniques for increasing the sensitivity of the measurement instrument to ensure reliable detection of all potential defects in the device under test. However, features which are not relevant, redundant or having low diagnostic value should be excluded from the following classification to keep the data size small and the processing fast and robust. Table 4 provides an overview of the most important techniques for reducing the dimensions of the feature space.

Transformation	Technique and application
Relativization	refers a measured value or curve (e.g., absolute distortion) to a reference (e.g., total sound pressure) to generate a relative quantity (e.g., distortion in percent).
Curve smoothing and decimation	is the simplest way to reduce the resolution of a curve. Prior to the decimation, an energetic averaging within a defined bandwidth (e.g., third-octave) is useful for fundamental SPL response, while taking the peak value in this interval is more advantageous for higher-order distortion.
Orthogonalization	converts an original set of possibly correlated features into a set of independent features using principal component analysis (PCA). The number of principle components is less than or equal to the number of original features. The principle components are ordered to account for decreasing variability in the data. This transformation is useful for reducing the number of data points in one-dimensional curves (e.g., SPL response) and two-dimensional data sets (e.g., time-frequency responses from STFT).
Prediction of perceptive attributes	is a transformation of physical features measured by an objective measurement technique into perceptive attributes explaining the subjective sensation of a customer or human operator (e.g., audibility of signal distortion (ITU 2001)).

Table 4. Techniques to reduce the number of features submitted to the classification process

5. Classification

After providing a set of relevant features from physical measurement, the next step is the generation of Pass/Fail verdicts and the identification of the physical cause of the defect.

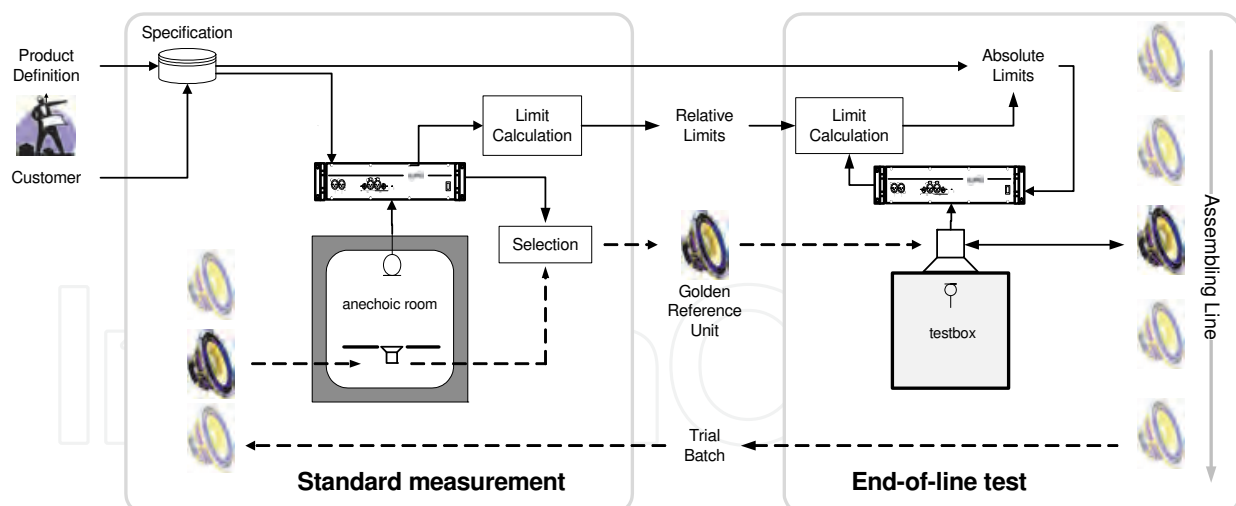

Fig. 15. Methodology for transferring specification limit defined for standard measurement condition (anechoic room) to corresponding specification limits valid for the special measurement condition (test box) used at the end of line

5.1 Pass/fail decision

Faulty units can be easily separated from functional units by comparing the measured variables with specification limits. Those limits correspond with either the target performance at the beginning of the product development, the quality found at the first

prototype or the requirement defined by the customer. Specification limits referring to standard measurement condition cannot be applied to end-of-line testing if the measurement conditions are different there. For example, most loudspeaker standards define the sound pressure output at 1 m distance from the drive unit operated in a baffle under free field condition. The test box as shown in Fig. 6 is smaller, less expensive and more convenient than an anechoic room, but requires a transformation of the specification limits.

This problem can be solved by selecting a limited number of units (usually 10 - 100) and performing a measurement under standard conditions as illustrated in Fig. 15. The functional units which fulfill the specifications are subject to a statistical analysis. After calculating the mean value and variance of all features, *Golden Reference Units* are selected which represent the ensemble best. Some of the absolute specification limits corresponding to standard measurement conditions are replaced by relative limits. Now a Golden Reference Unit and the corresponding relative limits are transferred to the assembly line and measured under non-conformal conditions (e.g., test box). Finally the relative limits are transformed into absolute limits used for end-of-line testing.

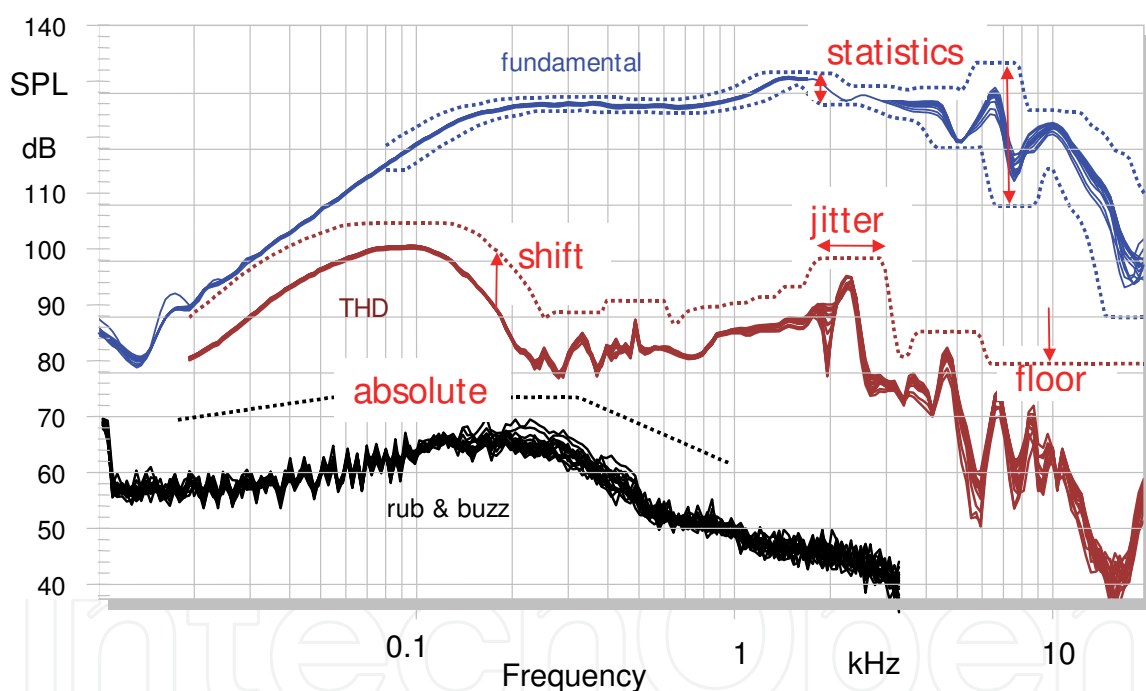

Fig. 16. Algorithms used for calculating specification limits based on statistical characteristics derived from reference units

The Golden Reference Unit is stored under manufacturing conditions and can be used to recalibrate the absolute limits at any time when temperature or humidity changes the behaviour of the device under test. This limit calculation process must also consider systematic differences between the just assembled unit where the properties are still varying (e.g., drying adhesive) and the Golden Reference Unit manufactured some time ago.

Special algorithms are useful to transfer or generate the specification limits. The shift algorithm is a simple way to generate upper and lower specification limits having a defined

distance to the mean value as shown in Fig. 16. If meaningful shifting values are not known, the width of the permissible corridor can be calculated from the variance of the measured variable. For example the upper and lower limits of the fundamental SPL curve in Fig. 16 correspond to ± 3 sigma and make the corridor wider at higher frequencies where the variance of the measured variable rises. The floor algorithm is a useful constraint which keeps the specification limit above a threshold. This is, for example, useful for total harmonic distortions which are acceptable if they are smaller than a defined level. A jitter algorithm increases the tolerances in the horizontal direction to cope with sharp peak and dips having a varying resonance frequency.

Statistical algorithms for limit definition have the benefit that only few setup parameters (e.g., shift value) have to be defined which are valid for similar kinds of products. The distance between the measured variable and the upper and lower specification limits may be used as a quantitative measure for grading the quality of the device under test and for assigning the device to a particular quality class.

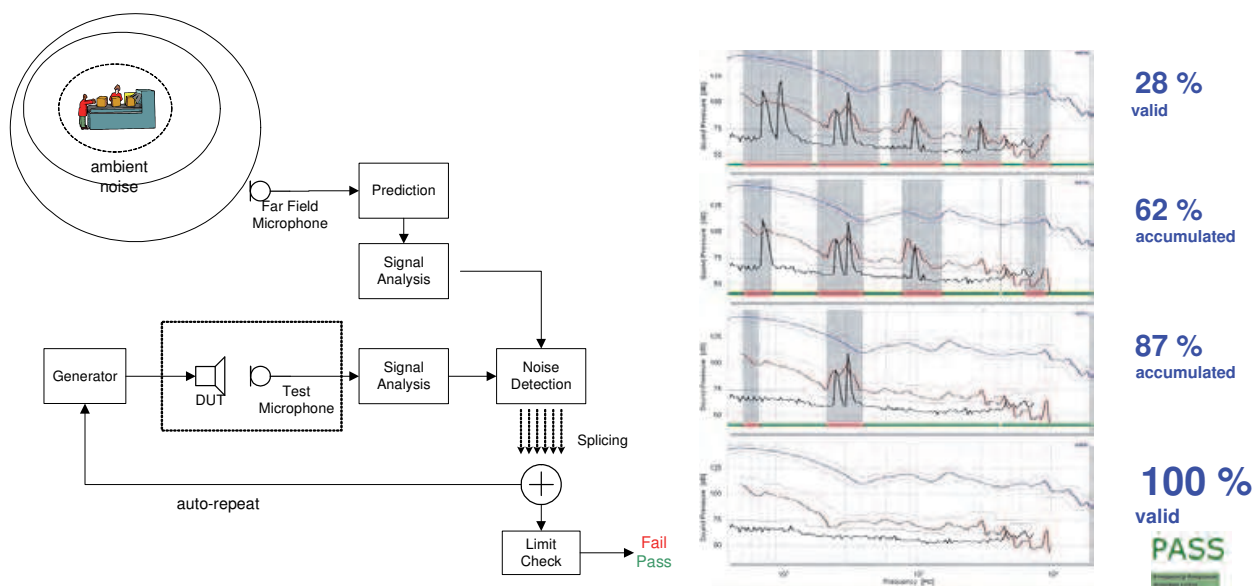

Fig. 17. Test system providing immunity against production noise by detecting invalid measurement and splicing valid parts of repeated measurements together

5.2 Detection of invalid measurements

A disturbance from an external source corrupting the monitored signal may invalidate the measurement. Acoustical measurements are especially prone to ambient noise generated in a production environment. A multiple sensor system such as a microphone array can be used for deriving the position of the source and to separate the test signal from the noise. If the test microphone is located in the near field of the loudspeaker as shown in Fig. 17 and a second microphone is located in the far field at some distance from the test microphone, an acoustical disturbance can be detected reliably. The grey sections in the SPL frequency response in the right-hand side of Fig. 17 show the corrupted parts of the measurement.

Invalid results require a repetition of the measurement, but it is beneficial to store uncorrupted parts of each measurement and to merge those parts with valid parts of the following repetitions resulting in complete valid set of data eventually. This auto-repeat and

splicing technique is an important element of ultra-fast testing providing immunity against random production noise.

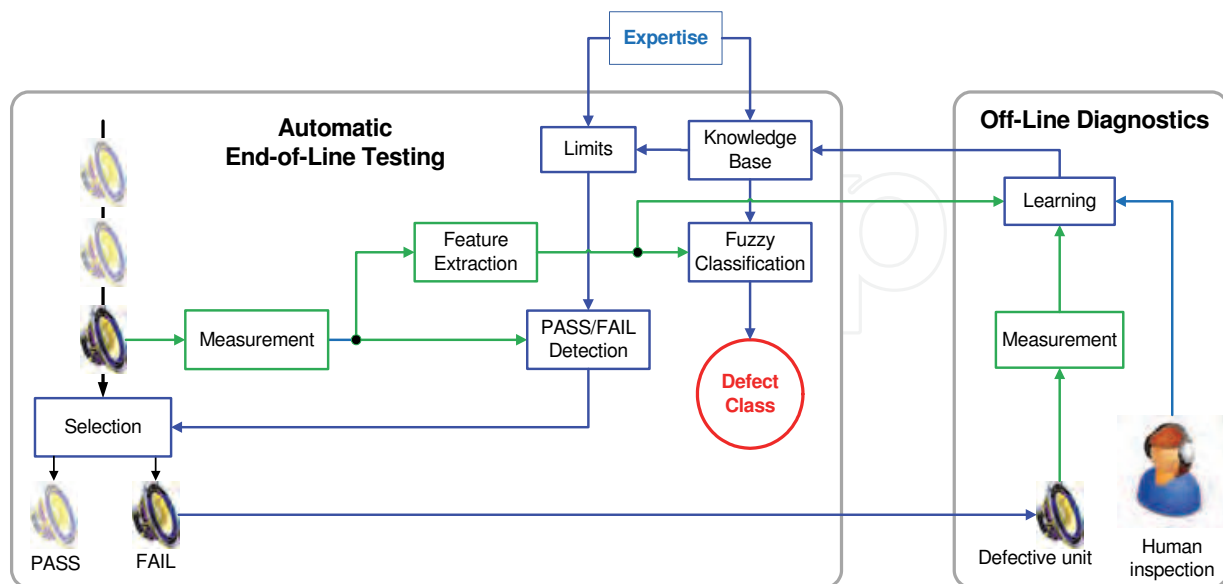

Fig. 18. Automatic classification of defects using information from an external expert and off-line diagnostic

5.3 Defect classification

If a device fails permissible specification limits, it is crucial to identify the physical cause of the defect as fast as possible to ensure timely control of the production process and to maintain a low rejection rate. To accomplish this task, an experienced operator or engineer from manufacturing or product design can perform additional measurements, visual inspection, destructive analysis or other kinds of off-line diagnostics as shown in Fig. 18. For loudspeaker evaluation, new auralization techniques are also useful, providing more sensitivity for defects than normal listening tests. Signal processing can enhance critical distortion components while protecting the operator's ears against the fundamental component's high sound pressure. However, those tools cannot replace the expertise the human investigator has accumulated over time and cannot be transferred to other co-workers.

A new objective of end-of-line testing is combining the results of objective testing with the background information about the physical nature of the defect. The first step in this process is the creation of a class, assigning it a meaningful name and storing all relevant information (symptoms, causes, remedies) in a knowledge base. Generic defect classes (e.g., "electrical shortcut") are already provided by the measurement instrument, but the particular defect classes are generated during the design process and permanently extended during manufacturing. The classifier in Fig. 18 uses this information to determine defect classes which correspond to the measured features at the highest likelihood. Fuzzy logic (Zadeh, 1987) can be used to combine the measured features with non-numeric linguistic variables such as "loudspeaker sounds distorted" and determine the membership of the defect classes. The output of the classification process is not only the name and probability value of the most likely defect class, but also a list of alternative classes at a lower rank. This information is not a strict assignment, but more a guided search process for the operator to determine the most likely defect class.

The verification of the proposed or assumed defect is part of the off-line diagnostics, usually performed on a separate measurement platform. The result of the human inspection is the most important input for the automatic learning process. The measured features of the defective device are used to update the properties of the defect prototype which represents an existing defect class. If the membership function of all existing classes is low or the QC operator detects a failure not known before, there is the opportunity to create a new defect class where the defective unit is identical to the prototype. An administrator who is usually the line leader or an experienced QC engineer supervises feedback of the operator and can unify two defect classes and may improve the verbal description of the defect. The expert system is a valuable tool for accumulating knowledge to train new, inexperienced co-workers and to simplify the communication between team members.

6. Quality monitoring and process control

Although the detection of defect units is the basic objective of end-of-line testing, the properties of the functional units passing the test also provide valuable information about the stability of the production process. Statistical analysis applied to this data reveals drifts and trends early enough to readjust the process before faulty products are produced.

6.1 Statistical analysis

The first step of quality monitoring and process control is the calculation of basic statistical characteristics of the measured variables (e.g., resistance) and classification results (e.g., counts of defects) as summarized in Table 5.

Basic characteristic	Description and application
Histogram	is used to measure the distribution of a variable by counting the number of points in equally sized, non-overlapping intervals on the data range. The normalized histogram estimates the probability density function pdf and reveals important properties of the distribution (center, spread, skew, outliers and multiple modes).
Arithmetic Mean \bar{x}	is the sum of data points x_i of a measured variable divided by the number N of observations.
Median \tilde{x}	corresponds to the value of the data point which separates the higher half of the population from the lower half. The median describes the central value of skewed populations more usefully than the mean value and suppresses the effect of outliers.
Exponentially Weighted Moving Average (EWMA)	performs a smoothing of the measured data series x_i versus unit index i (or time) by decreasing the weights of old data. The EWMA is used in control charts to detect small shifts and trends at a higher sensitivity than using the mean value calculated in subgroups.
Sample Standard Deviation σ	describes the variability of the measured single-valued variable x_i .
Range R	is calculated by subtracting the lowest value (minimum) from the highest value (maximum) found in subgroups.
Rejection Rate RR	is the ratio of non-confirmative or defective units failing the end-of-line test to the total number of units tested. The rejection rate is the complement of the process yield.
Defects Per Million Opportunities (DPMO)	is the number of defects (or non-conformities to the specifications) referred to the product of measured devices times the number of defects possible in one unit.

Table 5. Basic statistical characteristics important for end-of-line testing

The calculation of those basic characteristics does not require much processing power and can be accomplished by the computer used as part of the end-of-line tester. This provides an additional benefit as warning and alarm signals can be generated automatically and used as feedback at the end of assembly line.

6.2 Process stability

Statistical process control (SPC) separates variations arising from common causes typical to a particular production process (e.g., manual soldering of wires) from unanticipated, special causes (e.g., a new batch of parts with different properties is assembled). Common-cause variations are stable and predictable while special-cause variations have an atypical pattern and are unpredictable, even from a probabilistic point of view, and may require action to stabilize and adjust the process.

The Control Chart is a powerful tool for separating common and special causes. The chart displays the quality characteristic versus time or sample number in comparison with two horizontal lines, the upper control limit (UCL) and the lower control limit (LCL). A centre line between the UCL and LCL curves describes the long-term mean value of the process under control. There are many types of charts applicable to variables (e.g., individual data point of the measured feature, mean value, range) or attributes (e.g., counts of nonconforming units, proportions) of different subgroup sizes based on different statistical assumptions (e.g., underlying distribution) and performance (e.g., sensitivity for shifts). Table 6 describes some of the important charts (further details see Montgomery, 2005).

Control chart	Definition and application
\bar{x} and σ Chart "X-Bar and S Chart"	contains a pair of charts used to monitor the (short-term) mean value and standard deviation of the variable observed over a relatively large number of units ($n > 10$) in regularly sampled subgroups. This chart is sensitive for detecting shifts larger than 1.5σ .
\bar{x} and R Chart "X-Bar and R Chart"	contains a pair of charts used to monitor the (short-term) mean value and maximal variation (range) of the variable observed over a relatively small number of units ($n < 10$) in subgroups. This chart is sensitive for detecting shifts larger than 1.5σ .
EMWA Control Chart	uses the exponentially-weighted moving average to detect small variation (between $0.5 - 1.5\sigma$) caused by special causes which would be otherwise assigned to the common cause variation using the \bar{x} or other standard control charts. The increased sensitivity for shifts and trends is gained without increasing the chance for false alarms.
P Chart	is a control chart applied to the ratio (proportion) of nonconforming units to the total number of units using data generated by Pass/Fail decision.

Table 6. Important control charts for assessing process stability

Comparing the quality characteristic (variables and attributes) with the upper and lower control limits derived from the long term mean value and variability of the process can reveal a critical "out of control" status. Other rules (WECO, 1956; Nelson, 1984) consider additional zones at lower variance and are more sensitive to small shifts and trends. According to the WECO rules, a process is "out of control" if one of the following occurs:

- a single point is outside the $\pm 3\sigma$ range,
- two out of three successive data points are beyond the $\pm 2\sigma$ range,
- four out of five successive points are beyond $\pm 1\sigma$ range or
- eight successive points are on one side of the centre line.

6.3 Process capability

If the production process is stable, it is possible to predict the output of the process by using dedicated characteristics as listed in Table. 7.

Characteristic	Definition and application
Process Capability Index C_{pk}	assesses the ability of a process considering the common causes of variation expressed by estimated mean value μ and standard deviation σ of the measured variable to produce output within given upper and lower specification limits USL and LSL, respectively. Montgomery (2005) recommends a minimal C_{pk} value of 1.33 for an existing process and 1.5 for a new process using two-sided specification.
Process Performance Index Ppk	requires a calculation similar to the process capability index C_{pk} , but can also be applied to an instable process not yet under control. It considers not only the common causes, but also special causes of variance in the process caused by shifts and drifts.

Table 7. Characteristics assessing the performance of the process

The yield of the production process corresponds to the process capability index C_{pk} , if the process is normal distributed and stable. For example a $C_{pk}=1.33$ gives a process yield of 99.99 %. To keep the rejection rate below 3 defects per million opportunities (Six sigma) the short term C_{pk} should be larger than 2. A first estimate can be achieved by using a few data points (> 17) but the prediction becomes more precise by using long-term estimates of μ and σ based on a larger number of observations.

6.4 Process adjustment

The control charts and the indices of process capability reveal one or more problems somewhere at the assembly line which require immediate actions to prevent an increase of the rejection rate. If the relationship between symptom and physical cause is not known, a solution for the problem can be searched by a trial and error method. The success of this approach depends on the intuition and experience of the investigator. A more systematic approach is the fault analysis techniques as listed in Table 8 collecting information on potential problems and optimal remedies.

The ability to act as quickly as possible when the process becomes instable and incapable is vital. The continuous improvement process (CIP) and the failure mode and effects analysis (FMEA) are examples of evolutionary methods for accumulating knowledge before a potential failure occurs. Because of practical experiences during the development of the product, the expertise of the R&D engineers is an important source. This information has to be documented in a format (e.g., fishbone diagram) and language suitable for application at the assembly line. If the manufacturing is outsourced to a contract manufacturer, this know-how will be transferred only if both companies are interested in a close and long-term relationship.

New measurement techniques exploiting physical modelling of the device under test and system identification make the relationship between symptoms, causes and remedies more transparent. For example, Fig. 19 shows the adjustment of the rest position of the voice coil in loudspeaker manufacturing. The rest position of the voice coil depends on mechanical suspension which is made out of impregnated fabric, rubber, foam and other material having varying properties. An offset from the optimal rest position may cause signal distortion which impairs the perceived sound quality. However, the measurement of the

Method	Description and application
Failure Mode and Effects Analysis (FMEA)	is an inductive method which captures engineering knowledge and experience with similar products, then identifies potential failure modes in future by defining causes, effects and actions and by rating severity, likelihood and detectability (Kmenta& Koshuke, 2004).
Root Cause Analysis (RCA)	attempts to find, correct or eliminate the cause of the problem as opposed to coping with obvious symptoms only (Andersen, 2006).
Fault Tree Analysis	is a deductive method which explains the undesired event by a logical combination of initial faults, external events in subsystems using Boolean logic (AND, OR gates), (IEC, 2006).
Fishbone Diagram	proposed by Ishikawa (1990) collects all causes and reasons grouped into major categories (e.g., people, material, measurements, environments).
Why-Because Analysis	is a more a posteriori analysis method developed for investigating causal relations between factors contributing to an accident.
Poerto chart	highlights the most important factors (sources) of defects according to the occurrence, cost, frequency of customer complaints or other quality criteria. This chart typically shows bars and line graphs where the bars represent the individual value of the defects in descending order and the lines show the cumulative value (Wilkinson, 2006).
Continuous Improvement Process (CIP)	is an ongoing effort to achieve incremental improvement using feedback from measurement instruments, statistical process control, ideas from customers, operators, QC and design engineers (Imai, 1997).
Design of Experiments	is a methodology (proposed by Fisher, 1971) to gather information on the effect of some controlled treatments applied to experimental units using comparison, randomization, replication and other principles.

Table 8. Methodologies used for initiating the optimal action in process control

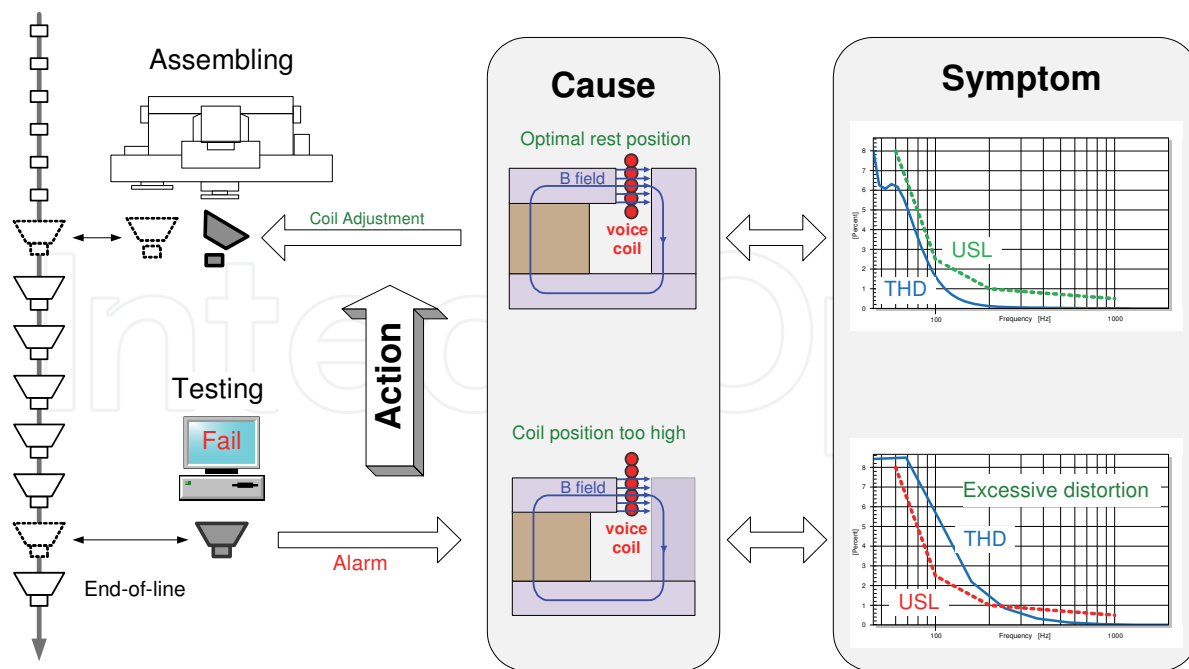

Fig. 19. Increasing the yield rate of the manufacturing process by process control (e.g., by voice coil adjustment using measured coil offset in mm using information generated during end-of-line testing)

total harmonic distortion (THD) is only a symptom and is less suitable for process control. Nonlinear identification techniques as discussed in Fig. 13 reveal the voice coil position and provide a quantitative value (in mm) for the adjustment of the voice coil position. The detection of a voice coil offset and a proper readjustment can be realized as continuous feedback control in automated assembly lines used for micro-speakers in telecommunication applications.

7. Data archiving and reporting

End-of-line testing produces an enormous amount of data. This section discusses alternative ways of storing the results in an effective format to support statistical analysis and the distribution of relevant information to different recipients.

The results of end-of-line tests reflect the quality of the total production process and are not only interesting for manufacturing, but also for the supplier of parts, design engineers in the R&D department, QC management and customers. However, each group needs a different part of the data. For example, manufacturing should immediately receive all parameters which are the basis for process control; however, those data are less important for the customer who is more interested in the overall quality of the products. The management is usually satisfied with the number of devices tested and the process yield. The designer from the R&D department is more interested in detailed measurement results of defective devices under test to understand the physical cause of the problem and discovering clues for improving design or simplifying manufacturing. The parts supplier (e.g., diaphragms in loudspeakers) only needs parameters (e.g., resonance frequency) which are important for his quality control and to address possible customer complaints. There is usually not enough time during end-of-line testing for isolating this information and generating a separate output file for each recipient in his preferred format. This problem becomes critical if the individual results of all measured devices under test are stored to ensure traceability about every step in the process chain. In this case, each device under test is identified by bar code or printing an individual label for each device under test. The computer associated with the measurement system is only used for writing a short entry for each measured device in the log file (i.e., general information such as serial number, date, time, verdicts, Pass/Fail result and selected important single-valued parameters).

In many applications, a digital format (e.g., database) is the only way to transfer a large amount of data (e.g., curves) as quickly as possible to a central computer (e.g., server) where the data is stored temporarily and the output file for each recipient is generated by a separate extraction process. The central storage of the test results allows, for example, matching loudspeaker units with similar acoustical properties which are sold as pairs to the customer.

8. Conclusion

Testing the manufactured device at the end of the assembly line differs significantly from the measurements performed during the development of the product. Most information, graphs, post-processing tools appreciated by an innovative R&D engineer are less useful in manufacturing where an identical replication of the prototype is important. End-of-line testing uses highly specialized test equipment providing limited information sufficient for quality assurance and process control. New sensor, signal analysis and system identification

techniques are used to ensure reliable detection of defects at an early stage before the product is shipped or mounted in the final application. Ultra-fast measurement techniques using an optimal stimulus are crucial for comprehensive testing within the available cycle time. End-of-line testing has to cope with measurement conditions which do not comply with R&D standards (e.g., anechoic room) and ensure comparability within the specification limits (e.g., transfer by Golden Reference Units). Invalid measurements caused by unavoidable disturbances in a production environment must be detected and repeated. This leads to new techniques (e.g., noise immunity) increasing the robustness of the test.

The measured physical variables and counts provided by end-of-line testing are the basis for process control. Trends and shifts must be detected early enough to adjust the process in time and to ensure a stable and capable production process (Six Sigma). Process control requires knowledge about the relationship between causes, symptoms and actions especially at automatic lines with continuous feedback and automatic adjustment of process parameters. One source of this knowledge is physical modeling provided by product development and applied to the particular requirements in manufacturing. A second source is the off-line diagnostic where a human operator investigates defective devices and extends the knowledge base continuously. This new task will replace manual handling and subjective evaluation which cannot meet modern requirement of 100 % testing of the products manufactured by an automated assembly line.

9. References

- Andersen, B. (2006). *Root cause analysis : simplified tools and techniques*, ISBN-13 : 978-0-87389-892-4, American Society for Quality, Quality Press, Milwaukee.
- ASTM (2009). *Standard Practice for Conducting an Interlaboratory Study to Determine the Precision of a Test Method*. American Society for Testing and Materials (ASTM), E691-09e1.
- Bendat, J. & Piersol, A. (1980). *Engineering applications of correlation and spectral analysis*, ISBN 0-471-57055-9, New York, Wiley-Interscience, 1993.
- Boashash, B. (2003). *Time-Frequency Signal Analysis and Processing – A Comprehensive Reference*, ISBN 0-08-044335-4, Elsevier Science, Oxford.
- Cabot, R. (1999). Fundamentals of Modern Audio Measurement, *Journal of Audio Eng. Society*, Vol. 47, Number 9, Sept. 1999.
- Fisher R.A. (1971). *The Design of Experiments*, ISBN 0028446909, 9th Edition, Macmillan.
- IEC (2006). *Fault Tree Analysis*, Edition 2.0. International Electrotechnical Commission. ISBN 2-8318-8918-9. IEC 61025
- Imai, M. (1997). *Gemba Kaizen: A Commonsense, Low-Cost Approach to Management*, 1st edition. McGraw-Hill. ISBN 0-07-031446-2.
- Irrgang, S. et. all (2006). Loudspeaker Testing at the Production Line. *Preprint 6845 presented at the 120th Convention of Audio Eng. Society*, May 2006.
- ITU (2001). *Recommendation BS.1387: Method for objective measurements of perceived audio quality (PEAQ)*.
- Ishikawa, K. (1990). *Introduction to Quality Control*. ISBN 4-906224-61-X, Chapman and Hall, 1991.
- Klippel, W & Seidel, U. (2003). Measurement of Impulsive Distortion, Rub and Buzz and other Disturbances. *Preprint 5734 presented at 114th Convention of the Audio Eng. Society*, Amsterdam March 2003.

- Klippel, W. (2006). Tutorial : Loudspeaker Nonlinearities - Causes, Parameters, Symptoms. *Journal of Audio Eng. Soc.* Vol. 54, Number 10, pp. 901-939.
- Klippel, W. & Schlechter, J. (2009). Fast Measurement of Motor Suspension Nonlinearities in Loudspeaker Manufacturing. *Journal of Audio Eng. Soc.*, Vol. 58 Issue 3, pp. 115-125, March 2010.
- Klippel, W. & Werner, R. (2010). Measurement of Turbulent Air Noise Distortion in Loudspeaker Systems, presented at the 129th Convention of Audio Eng. Soc., San Francisco, November 2010, preprint 8174.
- KLIPPEL GmbH (2011), QC System – 100 % Testing in Manufacturing, 21.3.2011, Available from <http://www.klippel.de/our-products/qc-system.html>
- Kmenta, S. & Koshuke, I. (2004). Scenario-Based Failure Modes and Effects Analysis Using Expected Cost. *Journal of Mechanical Design* 126 (6): 1027, November 2004.
- Montgomery, D. (2005). *Introduction to Statistical Quality Control*. Hoboken, New Jersey: John Wiley & Sons, Inc. ISBN 9780471656319.
- Nelson, L. (1984). Technical Aids, *Journal of Quality Technology* 16, no. 4 (October 1984), 238-239.
- Oppenheim A. & Schafer R. (2004). From Frequency to Quefrequency: A History of the Cepstrum, *IEEE Signal Processing Magazine*, Vol. 21, Issue 5, Sept. 2004, S. 95-106
- Percival, D & Walden, A. (2000). *Wavelet Methods for Time Series Analysis*, Cambridge University Press, 2000, ISBN 0-5216-8508-7.
- WECO (1956). *Statistical Quality Control handbook*. (1 ed.), Western Electric Company, Indianapolis, Indiana: Western Electric Co., p. v, OCLC 33858387
- Wilkinson, L. (2006). Revising the Pareto Chart. *The American Statistician* 60: 332-334.
- Zadeh, L. (1987), *Fuzzy Sets and Applications, Selected Papers*. Wiley & Sons, New York, 1987.

IntechOpen

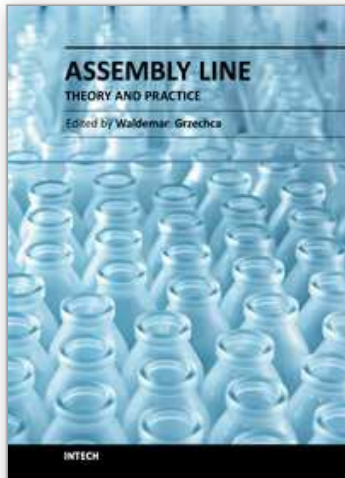

Assembly Line - Theory and Practice

Edited by Prof. Waldemar Grzechca

ISBN 978-953-307-995-0

Hard cover, 250 pages

Publisher InTech

Published online 17, August, 2011

Published in print edition August, 2011

An assembly line is a manufacturing process in which parts are added to a product in a sequential manner using optimally planned logistics to create a finished product in the fastest possible way. It is a flow-oriented production system where the productive units performing the operations, referred to as stations, are aligned in a serial manner. The present edited book is a collection of 12 chapters written by experts and well-known professionals of the field. The volume is organized in three parts according to the last research works in assembly line subject. The first part of the book is devoted to the assembly line balancing problem. It includes chapters dealing with different problems of ALBP. In the second part of the book some optimization problems in assembly line structure are considered. In many situations there are several contradictory goals that have to be satisfied simultaneously. The third part of the book deals with testing problems in assembly line. This section gives an overview on new trends, techniques and methodologies for testing the quality of a product at the end of the assembling line.

How to reference

In order to correctly reference this scholarly work, feel free to copy and paste the following:

Wolfgang Klippel (2011). End-Of-Line Testing, Assembly Line - Theory and Practice, Prof. Waldemar Grzechca (Ed.), ISBN: 978-953-307-995-0, InTech, Available from:

<http://www.intechopen.com/books/assembly-line-theory-and-practice/end-of-line-testing>

INTECH
open science | open minds

InTech Europe

University Campus STeP Ri
Slavka Krautzeka 83/A
51000 Rijeka, Croatia
Phone: +385 (51) 770 447
Fax: +385 (51) 686 166
www.intechopen.com

InTech China

Unit 405, Office Block, Hotel Equatorial Shanghai
No.65, Yan An Road (West), Shanghai, 200040, China
中国上海市延安西路65号上海国际贵都大饭店办公楼405单元
Phone: +86-21-62489820
Fax: +86-21-62489821

© 2011 The Author(s). Licensee IntechOpen. This chapter is distributed under the terms of the [Creative Commons Attribution-NonCommercial-ShareAlike-3.0 License](#), which permits use, distribution and reproduction for non-commercial purposes, provided the original is properly cited and derivative works building on this content are distributed under the same license.

IntechOpen

IntechOpen