

We are IntechOpen, the world's leading publisher of Open Access books Built by scientists, for scientists

4,800

Open access books available

122,000

International authors and editors

135M

Downloads

Our authors are among the

154

Countries delivered to

TOP 1%

most cited scientists

12.2%

Contributors from top 500 universities



WEB OF SCIENCE™

Selection of our books indexed in the Book Citation Index
in Web of Science™ Core Collection (BKCI)

Interested in publishing with us?
Contact book.department@intechopen.com

Numbers displayed above are based on latest data collected.

For more information visit www.intechopen.com



Nanocrystalline Porous Silicon

Sukumar Basu and Jayita Kanungo

IC Design & Fabrication Centre

*Dept. of Electronics and Telecommunication Engineering, Jadaopur University
India*

1. Introduction

Porous silicon can be considered as a silicon crystal having a network of voids in it. The nano sized voids in the bulk silicon result in a sponge-like structure of pores and channels surrounded by a skeleton of crystalline Si nano wires. Porous silicon (PS) is gaining scientific and technological attention as a potential platform mainly for its multifarious applications in sensing and photonic devices (Canham, 1997a; Pavesi & Dubos;1997; Dimitrov,1995; Tsamis et al., 2002; Archer & Fauchet, 2003; Barillaro et al.,2003). The extremely large surface to volume ratio ($\geq 500\text{m}^2/\text{cm}^3$) of PS, the ease of its formation, control of the surface morphology through variation of the formation parameters and its compatibility to silicon IC technology leading to an amenability to the development of smart systems-on-chip sensors have made it a very attractive material. Due to these multi functional applications of PS, recently it has been proposed to be an educational vehicle for introducing nanotechnology and inter-disciplinary material science by eminent scientists working in this field. But in order to develop porous silicon based devices and their integration to electronic circuits the low resistance stable electrical contacts are necessary. However, unlike crystalline silicon the outstanding problem with PS is the instability of its native interface with a metastable Si-H_x termination (Tsai et al.,1991). The metastable hydro-silicon can undergo spontaneous oxidation in ambient atmosphere and results in the degradation of surface structures. This also creates problems to get a stable Ohmic contact (Deresmes et al.,1995; Stievenard & Deresmes, 1995) which is again a very important factor regarding its commercial applications. Therefore passivation of surface is necessary to make stable porous silicon based devices. For that purpose substituting surface hydrogen by another chemical species has appeared desirable. Oxidations (Rossi et al, 2001; Bsiesy, et al 1991; Petrova-Koch et al., 1992) nitradation (Anderson et al., 1993) and halogenation (Lauerhaas & Sailor, 1993) are found to be useful for PS surface passivation. Derivatization by organic groups and polymer (Lees et al. 2003; Mandal et al. 2006), offers an alternative possibility to stabilize the material. Metals like Cu, Ag, In etc. were also used to modify the porous silicon surface to stabilize its photoluminescence properties (Andsager et al 1994; Steiner et al., 1994). Surface modification of PS using noble metals like Pd and Pt has also been studied recently (Kanungo et al. 2009a).

The details on PS are given in a comprehensive review published by Cullis et al. (Cullis et al., 1997) and in the handbook on Porous Silicon properties edited by Canham (Canham, 1997a). H. Foll et al. (Foll et al. 2002) and V. Parkhutik (Parkhutik, 1999) also elaborately reviewed the formation and applications of porous silicon.

2. Preparation of nanocrystalline porous silicon using different chemical methods

Several methods are developed to make the porous layer with wide variation of pore morphologies having the pore dimensions from micro to nanometers. Chemical etching of silicon using chemical solutions of HF, HNO₃ and water (Vasquez et al., 1992), NaNO₂ and HF or CrO₃ and HF (Beale et al., 1986; Zubko et al. 1999) are employed for PS formation. However, the most widely used method is the electrochemical etching of silicon crystal in an electrolyte solution of HF and ethanol or methanol (Saha et al., 1998; Kanungo et al., 2006) or HF and water or HF and N, N dimethyl formamide (DMF) (Archer et al., 2005) by passing current for a fixed duration of time. Hummel et al. (Hummel & Chang, 1992) utilized a new spark erosion technique for PS formation, which does not involve any aqueous solution or fluorine contaminants in air or in the other gases. Another interested development in this area is the magnetic field assisted anodization technique employed by T. Nakagawa et al. (Nakagawa et al., 1996). Recently Y. Y. Xu, et al. (Xu, et al. 2005) describe hydrothermal etching of crystalline silicon in HF containing ferric nitrate to obtain the large quantities of regular, uniformly distributed silicon nano pillars which are perpendicular to the surface and well separated from each other. In addition, perpendicular electric field assisted method, illumination assisted method, Hall effect assisted method, lateral electric field method, Buried P-layer assisted method and their combinations have been very recently reported (Samuel, BJ., 2010).

In most cases, the porous silicon structure is formed by electrochemical etching of Si wafers in electrolytes including hydrofluoric acid (HF) and ethanol. The cleaned, polished Si wafer surface is hydrophobic. Added absolute alcohol increases the wettability of the substrate and thus helps the electrolyte penetrating into the pores. So laterally homogenous current density can be maintained to result in the formation of uniform PS layers. The added ethanol also helps in removing the H₂ bubble from the sample surface formed during the anodization process. To get the uniform porous layers with high reproducibility, the applied anodic current density, etching time and the electrolyte concentration are controlled precisely during the process. The cathode of the anodization cell is generally made of platinum or other HF-resistant conductive material. Platinum is used as cathode and Si surface itself acts as the anode. In Fig. 1, a conventional single tank setup is shown both for vertical and horizontal field application.

To get the nanocrystalline porous silicon on n-type silicon, illumination method (Samuel, BJ., 2010). is the most popular way to generate holes required in the electrochemical etching process (Fig.2). However, the photo energy absorption by the atoms depends on the intensity of the illumination source, the distance from the source and the electrolyte environment. Therefore, only the surface layer under the illumination generates electron hole pairs. But the etching rate gradually decreases with time as it is very difficult to reach the illumination into the deep area of the pores.

An alternative Hall Effect assisted method (Fig.3a) can be used for n-type porous silicon formation (Samuel, BJ., 2010). In this arrangement the sample is exposed to the Hall Effect environment. By applying a very large bias voltage and a large magnetic field, the upper layer of the semiconductor is depleted of electrons and is then inverted from n-type to p-type (Fig. 3b). The accumulated hole on the upper layer can participate in the chemical reactions during the etching process. Two main advantages of this method are (i) the

illumination sources are not required and (ii) no metal electrodes are needed for etching. Therefore, an etching container devoid of illumination and free of metal electrode can be well designed for the safety of handling the corrosive HF electrolyte so that the contamination from the metal electrode could be avoided.

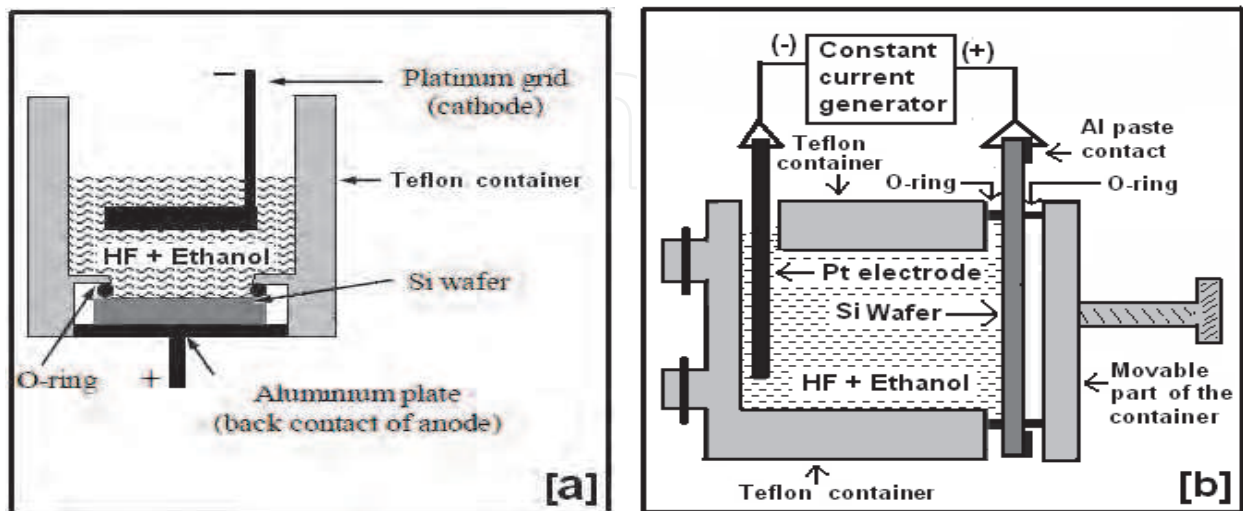

Fig. 1. Schematic of cross sectional view of the jig used for PS formation by electrochemical anodization by the application of electric field in (a) vertical and (b) horizontal mode.

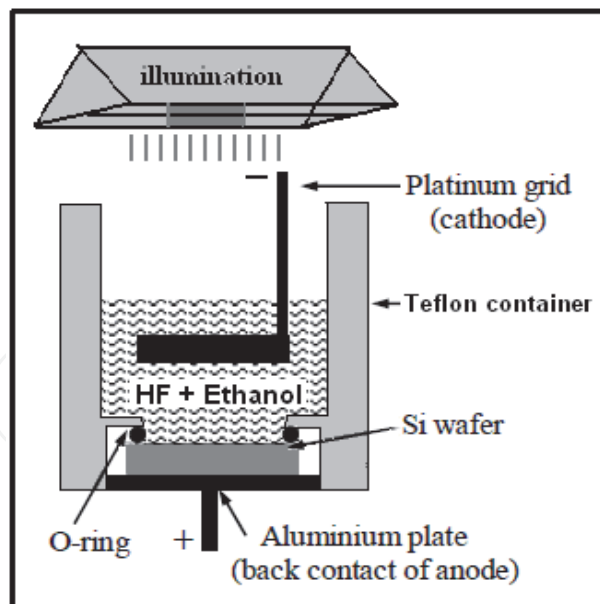

Fig. 2. Schematic of the experimental setup of the illumination assisted method.

A buried p-layer assisted method (Samuel, BJ., 2010) is also proposed for n-type porous silicon fabrication. The buried p-layer acts as the source of hole and is placed underneath the n-layer (Fig.4). The proposed buried p-layer assisted method can also be superimposed on the illumination assisted method during the electrochemical anodization.

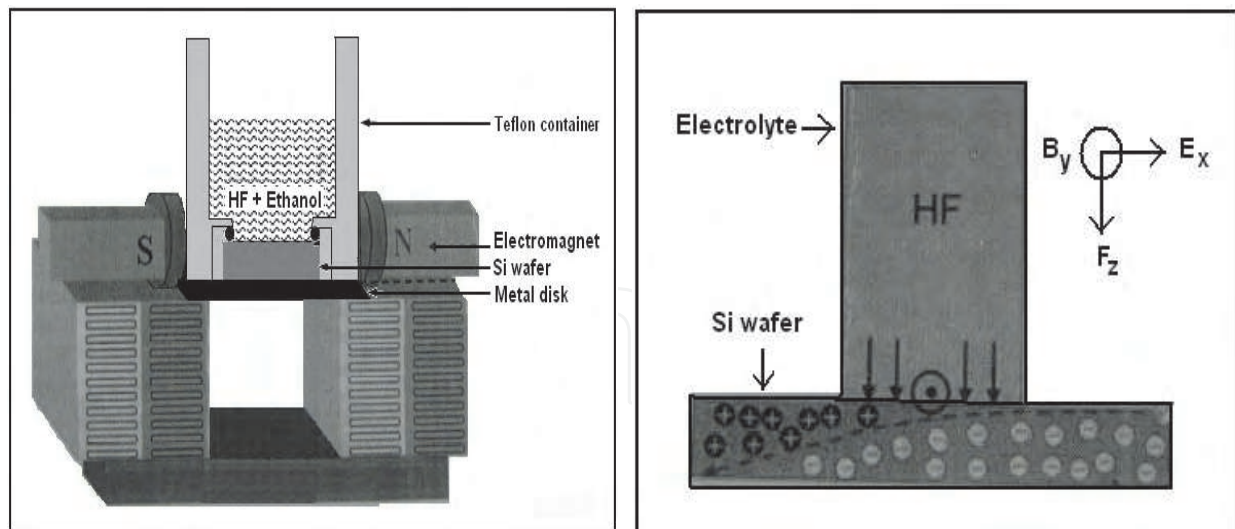

Fig. 3. Schematic of the (a) experimental setup of Hall effect assisted method and (b) the mechanism of pore formation [with the permission of Nova Science Publishers, USA].

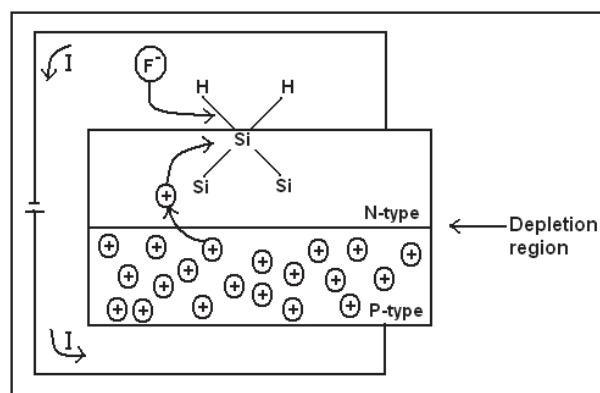
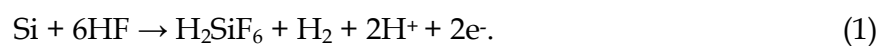

Fig. 4. The schematic mechanism of the biased pn structures for buried p-layer assisted method [with the permission of Nova Science Publishers, USA].

2.1 Mechanism of silicon dissolution and pore formation

Although the complete understanding of the Si dissolution mechanism is still under study, the mostly accepted theory describes that holes are required for pore formation. During the anodization process, the positively charged Si surface is oxidized by F^- ions followed by the formation of water-soluble H_2SiF_6 complex as shown in Fig.5. For the pore formation, the anodic reactions can be depicted as



However, the detail chemical steps during PS formation may be expressed as follows;

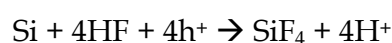
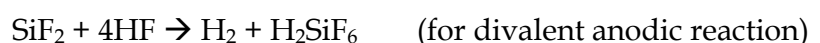
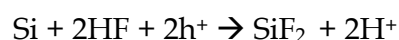

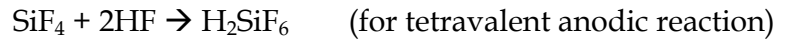

Different models are also proposed to explain the formation of porous silicon and the pore morphology. According to the model suggested by Kang and Jorne (Kang & Jorne, 1993) the distance between the pores varies as a square root of the applied voltage. The model by Beale et al (Beale et al. 1985) shown in Fig. 5a highlights a quantitative idea about the pore morphology. They pointed out that there is a space charge region between the PS layer and bulk silicon. This model further considers the pinning of the Fermi level at the Si/electrolyte interface. It is due to a large number of surface states that create Schottky barrier between the semiconductor and the electrolyte. The decrease of the Schottky barrier height occurs due to the dissolution of the pore tips because of the electric field generated in that region.

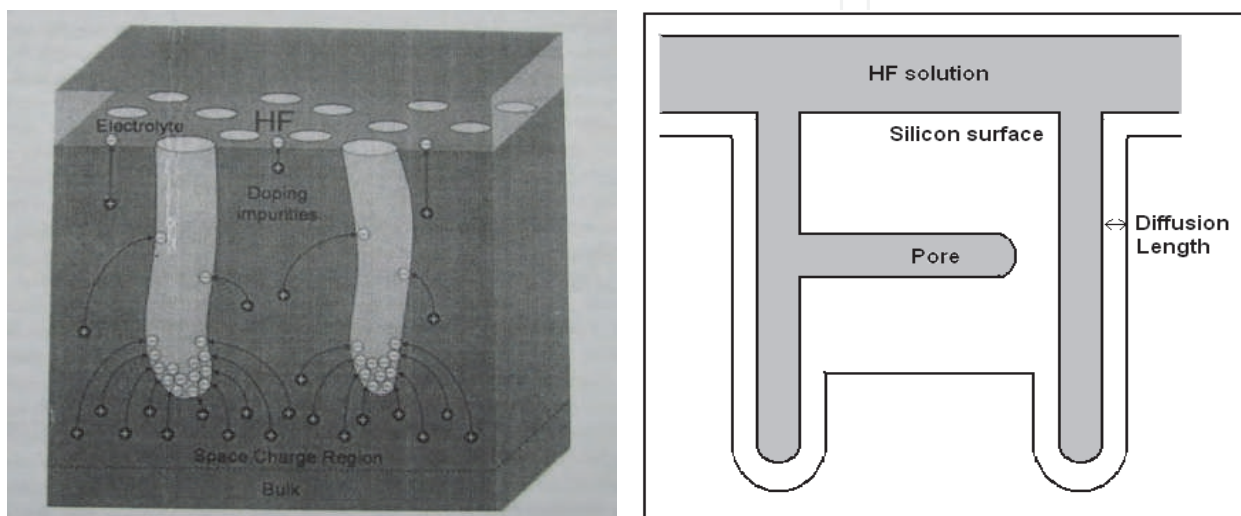

Fig. 5. The schematic of the (a) Beale model and (b) The diffusion - limited model (Samuel, BJ., 2010) [with the permission of Nova Science Publishers, USA].

The distribution of the electric field in the pore tips can be estimated by the model proposed by Zhang (Zhang, 1991) that also gives reasonable explanation of the localized dissolution of silicon. According to this model PS growth takes place through anodic oxidation and dissolution through direct etching of silicon in HF.

The diffusion-limited model in Fig. 5b proposed by Smith and Collins was the first computer simulated theoretical model. According to this theory the holes diffuse to the Si surface and react with the surface atoms (Samuel, BJ., 2010)..

Recently Lehamann proposed a model (Fig. 6) that considers the quantum confinement of charge carriers on the pore walls due to their small thickness and it may be responsible for the pore formation (Samuel, BJ., 2010).

The explanation of pore nucleation, pore structure and the importance of the formation parameters etc. during PS formation has been provided in the model proposed by Parkhutik and Shershulsky (Parkhutik & Shershulsky, 1992). According to this model the bottoms of the pores are covered by a virtual passive layer (VPL) that prevents a direct contact between the electrolyte and the substrate. When the electric field is applied the dissolution of VPL takes place and the pores are formed. The growth of VPL and its dissolution are exponentially related to the electric field strength and are dependent on the chemical reactivity of the material towards the electrolyte and other experimental parameters.

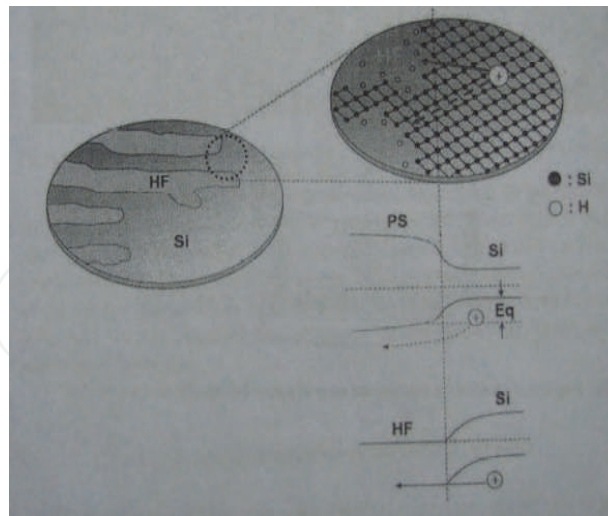

Fig. 6. The schematic of the proposed quantum model of Lehmann (Samuel, BJ., 2010) [with the permission of Nova Science Publishers, USA].

A new model on the mechanism of the pore growth suggests that the pore propagation into the crystal volume is a process that is controlled not only by the electrochemical factors, but also by mechanical stresses and hydrogen-related defects in Si. The PS growth is the alignment of the pore nucleation sites along the crystal defects of the Si surface. The defects serve as easy paths for the pore propagation. The dynamic stress during pore growth is another important issue. At the bottom of each pore, the dissolution reaction liberates the essential amount of hydrogen (Parkhutik, 1999). Outward movement of gas bubbles and products of Si dissolution together with inward propagation of fresh electrolyte are to produce essential hydrodynamic pressure inside the porous silicon layer. According to the theory of propulsion the essential tensile stresses are produced both in porous silicon and in Si substrates. Therefore, the micro cracks are formed in PS (Fig. 7) and that serve as easy path for further pore growth.

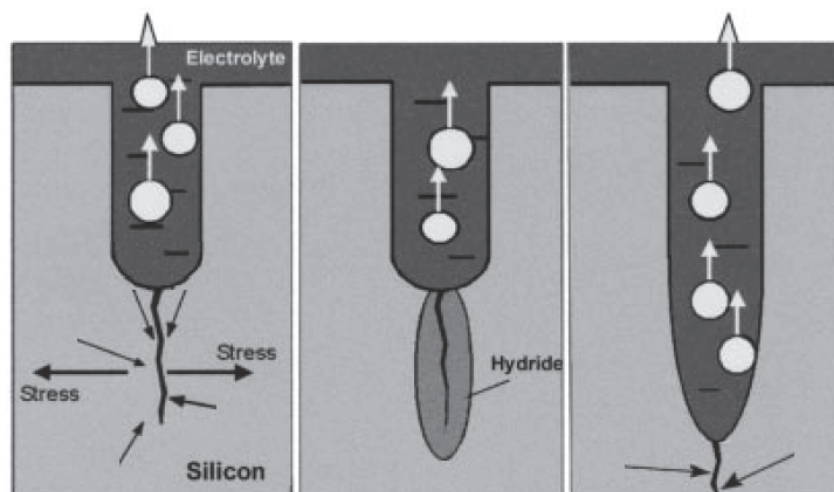

Fig. 7. Schematic of the pore growth according to the mechanical stress assisted mechanism of porous silicon (V. Parkhutik, 1999)

3. Properties of nanocrystalline porous silicon

The pore morphology of the PS layer characterized by the void fraction or porosity, the mean size of the pores, the pore size distribution, the interconnectivity of the pores, the passivation and mean size of the skeleton enclosing the pores depends on the formation parameters of PS, the additives in the electrolyte solution and the doping concentration of the silicon wafer. However, vertically grown uniform pores can also be developed in n-type c-Si using photolithography.

3.1 Structural properties of porous silicon

The main structural parameters of the porous silicon are the pore type, pore size, porosity and porous thickness. FESEM, TEM, AFM etc are commonly used to study the porous silicon structure. Fig. 8 shows the FESEM of nano and macro porous silicon as developed in the authors' laboratory.

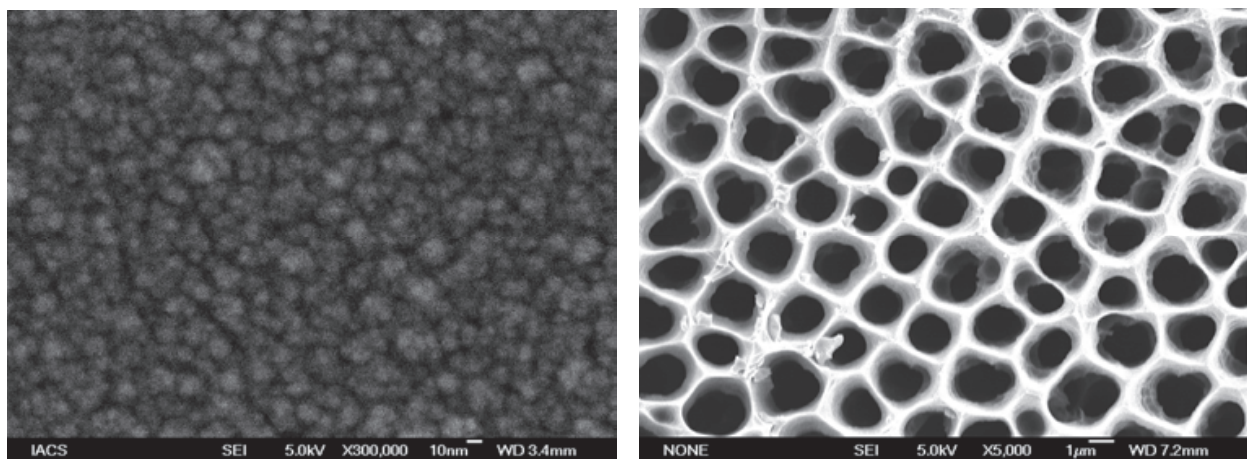

Fig. 8. FESEM of (a) nano porous and (b) macro porous silicon surfaces.

Most of the pores in porous silicon are closed at one end and they are inter connected to each other. Pores open at both ends i.e. the free standing porous silicon can also be realized in membrane structure. The cylindrical pore with 'branching' is very common in porous silicon. But for nano porous silicon a gradual decrease in pore size with depth in thick porous layer is observed. This arises due to the secondary dissolution since the top layer is exposed to the electrolyte longer than the bottom layer. Pore size is also a very important parameter for the PS based sensing devices. The nano, meso and macro porous silicon are defined in Table 1 according to the IUPAC guideline (Canham, 1997a),

Pore width	Pore type
< 2 nm	Micro porous/ nano porous
2 nm - 50 nm	Meso porous
> 50 nm	Macro porous

Table 1. IUPAC classification of pore size

The porosity of a sample is defined as the fraction of void in the porous structure. The porosity (P) and thickness (t) are determined by the relations:

$$P = (m_1 - m_2) / (m_1 - m_3)$$

$$t = (m_1 - m_3) / (\rho \times A)$$

Where m_1 , the mass of the sample before porous silicon formation, m_2 , the mass after formation and m_3 , the mass of the sample after complete dissolution of the porous layer by 20% NaOH solution. ρ is the density of bulk silicon and A is the area of the porous silicon layer. The masses m_2 and m_3 are measured after drying the samples properly in the vacuum environment.

The porosity, thickness, pore diameter and microstructure of porous silicon depend on the formation parameters like composition of electrolyte, anodization current density, etching time, temperature, ambient humidity, wafer type and resistivity, illumination, and drying conditions (Table 2).

Increasing the values of	Porosity	Etching rate
HF concentration	Decreases	Decreases
Current density	Increases	Increases
Anodization time	Slightly increases	Slightly decreases
Wafer doping (p-type)	Decreases	Increases
Wafer doping (n-type)	Increases	Increases

Table 2. Effect of anodization conditions on the formation of porous silicon (Bisi et al. 2000).

3.2 Chemical properties of porous silicon

Porous silicon has a very high surface area. Therefore, it contains a high density of Si dangling bonds and impurities such as hydrogen and fluorine that are residuals from the electrolyte used during PS formation. After the formation, initially porous layer is covered by SiH_x (x = 1, 2, 3) bond that remains on the surface even after rinsing and drying the samples. However, it disappears during annealing at 300-500°C (Vázsonyi et al. 1993).

The PS surface oxidizes spontaneously if it is kept in the ambient air for a few hours and the process continues until the whole surface is oxidized. Illumination and increased temperature enhance the oxidation reaction rate. A blue shift in the luminescence spectra occurs after oxidation of the surface (Hossain et al. 2000, Karacali et al. 2003). It also affects the electrical conductivity and the optical properties of the porous layer (Astrova et al. 1999).

The common impurity in freshly prepared porous silicon is fluorine. The concentration of fluorine depends on the type of electrolyte used. It is commonly found in the form of SiF_x (x = 1, 2, 3). The fluoride concentration decreases with time (Petit et al. 1997), probably due to the replacement of SiF bonds by SiOH bonds through reactions with water vapor content of the ambient air.

3.3 Physical properties of porous silicon

3.3.1 Young's modulus

It is reported (Barla et al. in 1984) that PS should behave similar to the starting Si single crystal but the lattice mismatch occurs at the Si-PS interface due to its nanostructure and that may be the reason of different Young's modulus value of PS. The Young's modulus of

porous silicon has been investigated by using X-ray diffraction, acoustic wave propagation and nanoindentation technique. The data measured from these different techniques are in good agreement and it is observed that for the PS layer the Young's modulus decreases with increasing porosity as shown in Table 3 (Bellet 1997). Also the micro hardness of the PS layer decreases with the increasing porosity (Dutttagupta et al. 1997).

Sample	Method of investigation	Porosity (%)	Youn's modulus (GPa)
p ⁺	Acoustic technique	20	82.9
p ⁺	Acoustic technique	28	60
p ⁺	Acoustic technique	32	50.3
p ⁺	X-ray	34	41
p ⁺	X-ray	54	17
p ⁺	X-ray	74	11
p ⁺	Nanoindentation	80	5.5
p ⁺	Nanoindentation	90	0.87

Table 3. Young's modulus values of porous silicon deduced from different techniques. (Bellet, 1997)

3.3.2 Thermal conductivity

Nano porous silicon is a good thermal insulator. As reported in the literature the thermal conductivity of PS decreases with the porosity and in the case of nanoporous structures the thermal conductivity depends on the formation parameters. (Lang 1997).

Table 4 presents the experimental data for the thermal conductivity obtained from the literature. Electrically induced thermal wave were analyzed for thermal conductivity measurements by Lang et al. Photo thermal reflectance analysis and photoacoustic spectroscopy were also used by the other groups for the thermal conductivity measurements. However, the values given in the literature shows dramatic differences for different techniques.

Sample	Morphology	Porosity (%)	Thermal conductivity (as prepared) Wm ⁻¹ K ⁻¹	Thermal conductivity (after 300°C prepared) Wm ⁻¹ K ⁻¹
p-type	Nano porous	40	1.2	1.3
p-type	Meso porous	45	80	2.7
n-type	Nano+ macro	53	1.75	1.85

Table 4. Experimental data of thermal conductivity of porous silicon (W Lang, 1997)

As reported in the literature, due to the small size of structures, the thermal conductivity of p-type nanoporous silicon is 1.2 Wm⁻¹K⁻¹, which is less than the thermal conductivity of the silicon oxide. This is because of the nanostructure that does not transport heat easily and also the pores prevent the heat transfer from one elemental crystallite to the next. But when the material is partially oxidized, the thermal conductivity increases slightly. It is because of the incorporation of the oxygen into the structure, due to which the porosity decreases and as a result heat transport increases.

But for meso porous silicon crystallites are connected by small bridges that are oxidized at low temperature and create heat barrier, which must be overcome during the heat transport process. As a result the thermal conductivity decreases.

3.3.3 Electrical resistivity

The electrical resistivity of the PS layer is very high due to its nano structure. Four probe method is very commonly used for the conventional determination of the resistivity of porous silicon. But PS is very sensitive to the ambient atmosphere. So it is difficult to determine the exact values for the PS resistivity (Ben-Chorin, 1997). The resistivity of porous silicon changes with the porosity of the sample as it depends on the quantum confinement, mobility and drift of the carriers, changes in the band structure, temperature and on the medium inside the pores (Parkhutik, 1999).

To a large extent the low porosity material behaves like intrinsic bulk Si. The barrier heights are similar to the bulk silicon which suggests that the Fermi level lies near the mid-gap position. But the drift mobility of the majority carriers is order of magnitude lower than the bulk silicon. (Ben-Chorin 1997). Thermally activated carriers move in extended states, but multiple trapping in the surface states disturbs their motion. Therefore, the drift mobility is very low. And as the traps are energetically distributed throughout the gap, hopping between these states at high frequencies gives rise to a temperature independent AC conductivity

A strong increase of resistivity (10^{10} - 10^{12} Ωcm) of highly porous silicon was observed for high porosity samples due to the quantum confinement effect that results in a modulation of the effective bandgap. For these samples the AC conductivity is almost temperature independent at high frequencies (Ben-Chorin 1997). A non linear dependence of the conductivity with the applied voltage was observed for these samples. It is suggested that two parallel processes are involved in current conduction (Ben-Chorin 1997). The first one is the hopping transport of the carrier and the second one is the conduction due to the thermionic emission .

Both the low and high porosity samples are very sensitive to the environment. The exposure of the porous layer to the vapour of the polar solvents affects the conductivity. The conductivity depends exponentially on the partial pressure of the solvent and on its dipole moment.

3.3.4 Optical and optoelectronic properties

3.3.4.1 Refractive index

The effective refractive index of PS depends on the porosity, the impurities on the surface of porous silicon and the refractive index of the materials filling the pores. The refractive index of an oxidized PS layer is lower than the non-oxidized layer having the same porosity.

3.3.4.2 Absorption co-efficients

The absorption coefficient of the PS layer indicates the correlation between the bandgap and the porosity that is mainly due to the quantum confinement effect. (Bisi et al. 2000, Behren & Fauchet 1997). The absorption coefficient of porous silicon can be measured by optical transmission, photoluminescence excitation and photo thermal deflection spectroscopy. For a free standing PS layer the optical transmission method is very sensitive. In this case Fabry-Perot interference fringes are used to determine the refractive index. The absorption

coefficient is then calculated including both the multiple interference effect and the sample reflection. The absolute value of absorption coefficient can be obtained by the photoluminescence excitation method but not by photo thermal deflection spectroscopy (PDS). In fact, PDS is effective for estimating very low values of the absorption coefficient below the crystalline Si band gap.

As expected for an indirect band gap material, a linear behaviour of the transmission spectra of crystalline Si and p⁺ PS were observed. But a non linear dependence of the absorption coefficient on photon energy was obtained for p-type porous silicon with an absorption blue shift with respect to crystalline Silicon as reported (Bisi et al. 2000). It is determined from the Raman experiment that the blue shift is correlated with the smaller average crystallite diameter and the quantum confinement is considered as the key factor for the absorption in porous silicon.

3.3.4.3 Photoluminescence

Porous silicon shows photoluminescence at wavelengths ranging from the ultraviolet (Lin et al., 1996) to the infrared due to radiative recombination of the carriers confined in nanoclusters of Si embedded into the walls of PS layer. However, the physical mechanisms of photoluminescence from porous silicon are still the subjects of controversy. The most available reports on PL bands of porous silicon are available in different spectral regions e.g. (i) ultraviolet band, (ii) Visible band and (iii) Infrared PL band. The following are the characteristics of different PL bands of porous silicon.

- i. Ultraviolet PL band (<500 nm):
 - a. UV PL band in room temperature occurs mainly due to the oxidized porous silicon
 - b. PL shows a red shift in the peak intensity with time.
 - c. PL get quenched when exposed to methanol.
 - d. PL intensity and peak intensity are stable under illumination.
- ii. Visible PL band (500nm-800nm):
 - a. It requires silicon crystallites to get visible PL from porous silicon
 - b. Peak wavelength decreases as crystal size decreases.
 - c. PL intensity increases and a blue shift occurs with time.
 - d. Blue shift in peak wavelength occurs with surface passivation by hydrogen or by oxidation.
- iii. Infrared PL band (800nm-2 μm):
 - a. The radiative electron capture at positively charged dangling bonds on the surface of the silicon branches is responsible for the infrared PL band.
 - b. Sometimes this band is referred as the tunable IR band as the peak energy of this IR band is shifted as a function of porosity.
 - c. The relative intensity of the IR PL band increases with time.
 - d. The PL intensity is totally quenched at higher temperatures of around 450°C.

The following models of the photoluminescence from PS have been proposed following the classification by Canham (Cullis & Canham, 1991),

- a. Quantum confinement:

Quantum confinement within the nanometer size silicon branches of the porous silicon is responsible for direct band-to-band recombination and thus the origin of PL (Streetman, 1990). With decreasing crystal size a blue shift is observed (Canham, 1990a) because the reducing crystal size causes a further widening of the band gap. The band-gap energy shift

of silicon with temperature followed by the thermal broadening can explain the observed temperature dependence of the PL (Lockwood et al. 1992).

b. Nano-crystal surface states:

Due to quantum confinement effect (Koch, 1993) absorption of the carriers occurs in the silicon crystallites and as a result the recombination centers are formed due to an adjustment of the bond lengths and bond angles by silicon atoms at the surface of the crystallite. This adjustment leads to the formation of a number of traps or so called surface states within the band gap. Probably due to the confinement of the carriers in these states radiative recombine occurs by a tunneling mechanism and gives rise to PL.

c. Specific defects and spurious molecules:

The surface hydrides on the branches of the porous silicon (Tsai, 1991) are possibly responsible for the 'red' band PL. The tunable visible PL in PS may be attributed to SiH_x groups (Wolford et al., 1983). This may be further confirmed from the fact that on heat treatment (Prokes et al., 1992) hydrogen is desorbed from the porous silicon and thus the quenching of the PL with temperature (Cullis et al, 1997) due to presence of non-radiative dangling bonds. Further there is a report that surface molecules, specifically siloxene, a by-product of the anodization process and remaining on the surface of the porous silicon (Hamilton, 1995), may be responsible for 'red' PL band (Fuchs et al., 1992). After annealing at 400°C siloxene has an attractive luminescent property similar to porous silicon (Stathis & Kastner, 1987).

d. Structurally disordered phases:

A significant amount of amorphous silicon was reported to contain within porous silicon (Perez et al., 1992). It is known that hydrogenated amorphous silicon (a-Si:H) can produce visible PL (Vasquez, 1985) and so it was suggested that a-Si:H might be responsible for 'red' PL band (Vasquez et al. 1992) The observed tunability of the PL was further suggested as due to introduction of hydrogen into the amorphous silicon in varying amounts (Cullis & Canham, 1991).

3.3.4.4 Electro luminescence

The third form of the luminescence is the electro luminescence, which is tunable by an electric field applied on the sample (Halimaoui et al. 1991). PS produces different luminescent properties. 'The origin of luminescent phenomena is the quantum confinement in the nanostructure Si wires of porous silicon.' With increasing porosity crystallites dimension decreases and the band gap increases thereby shifting the peaks in the luminescence spectra (Read et al. 1992). As reported in the literature, the EL spectra show a blue shift with an increasing bias. However, the mechanisms of the electro luminescence in PS are not studied in detail. In fact, the absence of reliable electrical contact to PS due to the rough surface of silicon was so far the major difficulty in doing this study.

3.3.4.5 Cathodoluminescence

During the structural SEM or TEM study on PS Cathodoluminescence could be observed. The peak of Cathodoluminescence (CL) is extremely weak and unstable. But when SiO₂ is present stable and brighter CL could be achieved (Williams 1997). Piillai et al. (Piillai et al., 1992) suggested that during the SEM or TEM study the KeV electron beam may excite several high energy defect states of an unspecified molecules attached to the PS surface and their optical de-excitation gives the CL emission.

4. Surface stabilization of NPS by different methods

In spite of all other advantages, the major barrier preventing commercial applications of PS is the instability of its native interface with metastable Si-H_x termination. The metastable

hydro-silicon undergoes spontaneous oxidation in ambient atmosphere and results in the degradation of surface structures. This creates problem for taking good electrical contacts on PS, important for its commercial applications (Fig. 9). Therefore, the passivation of PS surface is necessary to make it possible to fabricate the stable devices based on porous silicon.

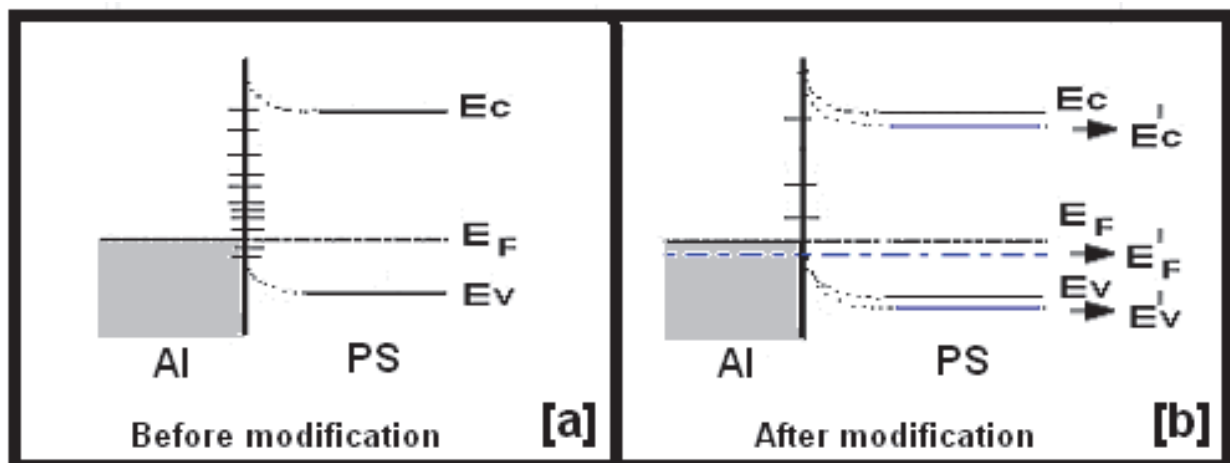

Fig. 9. Band diagram of Al/PS junction (for Ohmic contact to p type semiconductor $\Phi_m > \Phi_s$) (a) before surface modification (Fermi level is pinned by the PS surface states) and (b) after surface modification (Fermi level become unpinned and it can move under the applied bias).

In 1965, Beckmann (Beckmann, 1965) observed that during a long storage in ambient air the PS film gets oxidized. This chemical conversion is slow and basically similar to the ageing of Si wafers i.e. a native oxide layer forms on the surface of pores. Due to the ageing effect, the structural (Astrova et al. 2002), electrical and optical properties (Karacali et al., 2003) of PS showed continuous change with the time. The growth of the native oxide was completed approximately after one year (Petrova, et al., 2000). In order to avoid the transient period of ageing, substitution of surface hydrogen by another chemical species appeared desirable. Chemical, anodic, dry and wet thermal oxidation processes were investigated and presented by Rossi et al. in 2001. Anodic oxidation showed some improvement against ageing in air but rapid thermal oxidation appeared to give more optimum results, in providing PS samples with good electronic surface passivation and improved stability against ageing for optical measurements. For stabilization of the porous silicon surface, derivatisation by organic groups and polymer offers an alternative possibility to oxidation. Nitradation and halogenation were also studied to stabilize the PS surface. Metals like Cu, Ag, In etc. were also used to modify the porous silicon surface to stabilize its photoluminescence properties. The metal electrode contact to the unmodified PS surface for the electrical measurements may exhibit an unstable and rectifying behaviour, because PS surface states that arise due to its nano structure can act as the recombination centers. Therefore, the passivation of defect states in porous silicon is necessary to get a stable and reliable electrical contact to PS. There is an existing challenge for the fabrication of reproducible low resistance Ohmic contacts on porous silicon and it is indispensable for porous silicon based electronic devices. The PS layer contains huge number of volume traps and interface states, resulting in the Fermi-level pinning at the PS-Si interface. This may block the electrical response of the PS-Si structure. In a recent work the problem of contact on porous silicon was bypassed by taking contacts

from the back of the silicon substrate for capacitive sensors. A few reports are available on the formation of electrical contact to porous silicon. Zimin et al. (Zimin et al., 1995) reported a lateral Al ohmic contact to n type PS having a contact resistivity of the order of 10^{-3} to 10^{-2} Ω cm² for low porosity and low resistivity samples but they observed a rectifying behaviour for high resistive PS, both n and p type. Martin Palma and co-workers (Martin-Palma et al., 1999) reported the same for the Al-PS-Si-Al sandwich structure, which showed rectifying behavior even after prolonged exposure to the atmosphere. There are also reports on metallic contacts to PS using Au, In, Au-In, In-Sn, Al etc and all the contacts showed Schottky behavior (Angelescu & Kleps, 1998). Electroless Ni deposition was studied for getting metal contact to PS and an Ohmic behaviour was observed only for low bias voltages. H. A. Andersson et al. (Andersson et al., 2008) performed an experiment to examine the morphology and the properties of Ni obtained by electro less deposition on p-type PS and subsequent formation of Ni silicide by heat treatment. They showed that both rectifying and Ohmic contacts could be formed between electro less deposited Ni and PS depending upon the heat treatment conditions. Reports (Jeske et al., 1995) are also available on the use of electro less deposited Au, Cu and Ni contact to porous silicon. Although Au and Cu showed some positive results Ni was proved to be ineffective for Ohmic contact.

The stabilization of PS surface by noble metals for reliable metal contact has been recently reported by us (Kanungo et al. 2009a). We used the noble metal (Pd, Pt, and Ru) ions to stabilize the surface of porous silicon. Porous silicon surfaces were modified at room temperature by electroless method using acidic aqueous solutions of PdCl₂, RuCl₃ and K₂PtCl₆ to passivate the PS surface by the noble metals like Palladium (Pd), Ruthenium (Ru) and Platinum (Pt) respectively. To remove the native oxide layer from the PS surface, prior to modification the samples were dipped into 10% HF solution for 10 sec and were then immediately dipped into the different chloride solutions. Subsequently the samples were rinsed gently by DI water and dried followed by annealing in air at 110°C inside an electric oven for 10 min to evaporate the residual solvent present in the samples. The flow chart of the surface modification steps is given in Fig. 10.

To optimize the solution strength and modification time a number of experiments was carried out with different concentrations (0.1 M, 0.05 M, 0.01 M, 0.005 M, 0.001 M) of the solution and different modification time (5 sec – 180 sec). The stability and reproducibility were checked by taking I-V measurements.

The chemical modification steps are cited as follows:



Where, [M] = Pd, Ru and Pt.

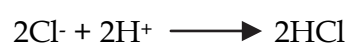
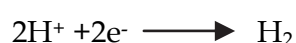

$[M]^{Z+}$ formed by decomposition of $[M]Cl_z$ in an aqueous acidic solution is reduced to $[M]$ metal islands by a chemical reduction process ((Jeske et al., 1995; Porter et al. 2002) and h^+ are released. Subsequently PS surface gets oxidized to SiO_2 by h^+ . The Pd modified samples showed the better consistency & stability compared to Ru and Pt modified samples as determined by I-V measurements.

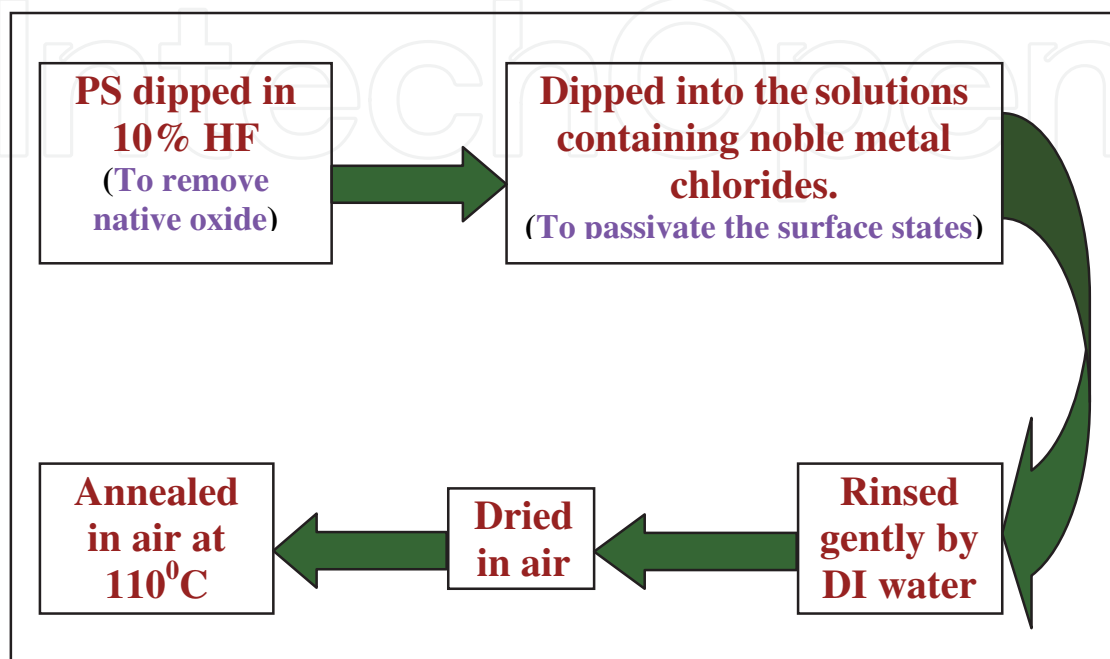

Fig. 10. Flow chart for porous silicon surface modification

This study indicates that the noble metal dispersed on the PS surface helps in two ways. Firstly, by the metal dispersion Si surface gets oxidized and a thin layer of SiO_2 is formed (Steiner et al., 1994) and it was verified from EDAX and XPS results (Kanungo et al. 2010a). Secondly, the oxidized PS surface contains much less defect states due to the passivation effect by the oxide layer. Therefore, it helps in favourable current conduction and also improves the stability of PS to a large extent. From the consideration of work function Al should give Ohmic contact to PS. But the large density of surface states on unmodified PS creates barrier against the current flow and thus a rectifying behaviour is displayed by it as shown in Fig. 9. But after modifications the PS surface states are reduced to a large extent by surface oxidation and Al contact becomes Ohmic in nature for the lateral structure (Fig. 11). On the otherhand, the sandwich structure (Fig. 12) exhibits a rectifying behaviour due to the presence of PS/Si heterojunction but the rectification is much improved after modification due to the effective passivation of the recombination states. However, the possible apprehension that Pd, Ru and Pt may create a continuous metal layer on the PS surface is ruled out by digital X-ray mapping and EDAX line scan analysis (Kanungo et al. 2010a) that show distinctly a discontinuous dispersion of noble metals.

Specific contact resistance of Al to Pd modified PS was measured by the transmission line model (TLM) method and the value obtained was of the order $\sim 10^{-1}$ ohm-cm² (Kanungo et al., 2009a).

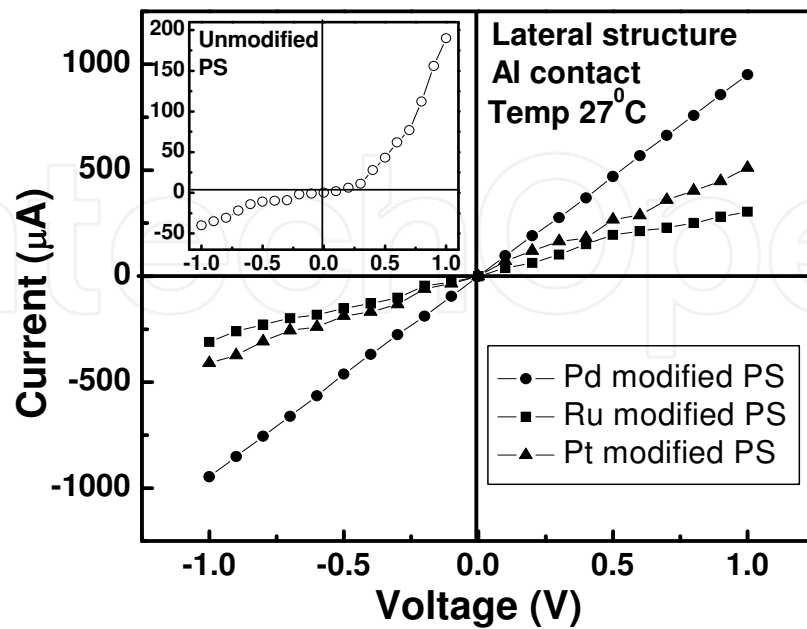

Fig. 11. I-V characteristics of unmodified (inset) and Pd, Ru and Pt modified PS for lateral structure using Al contact. [Unit is same for both the graphs].

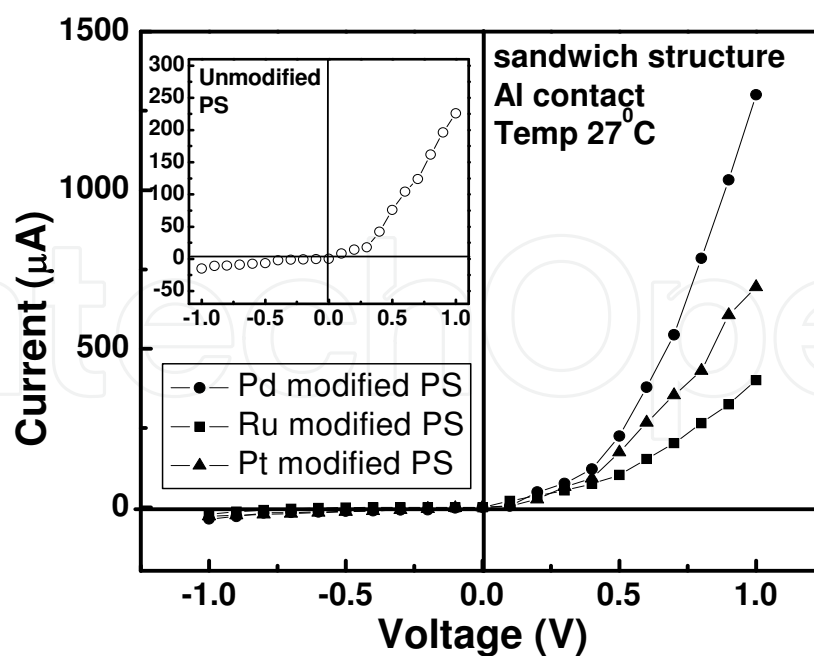

Fig. 12. I-V characteristics of unmodified (inset) and Pd, Ru and Pt modified PS for sandwich structure using Al contact. [Unit is same for both the graphs].

5. Applications of porous silicon

The PS structure was discovered by Arthur Uhlir at Bell Lab, USA in 1956 (Uhlir, 1956) followed by Turner (Turner, 1958) and Memming and Schwandt (Memming & Schwandt, 1966). In 1971, Watanabe and Sakai (Watanabe & Sakai, 1971) demonstrated the first application of PS for device isolation in integrated circuits. In 1986 Takai & Itoh (Takai & Itoh, 1986) introduced the silicon-on-insulator (SOI) in integrated circuits technology. The silicon on sapphire technology (SOS), and silicidation of porous silicon were reported by Ito et al. in 1989 (Ito et al., 1989). In 1984 Pickering et al. (Pickering et al., 1984) have observed the low temperature photoluminescence in PS. But the discovery of room-temperature photo- and electroluminescence by L. Canham in 1990 boosted the research on porous silicon because of the huge potential in silicon-based integrated sensing and photonic devices (Canham, 1990, 1997b, 1997c, 1997d; Canham et al., 1991).

Also there is a number of publications with the physical and chemical properties, and different applications of PS such as solar cells (Menna, 1997; Aroutiounian, 2004) integrated light-emitting devices on silicon chips (Bondarenko et al., 1997a, 1997b; Nakajima et al., 2004), selective chemical, gas and humidity sensors (Sailor, 1997), pressure sensors (Pramanik et al., 2005), bio-sensors based on functionalized PS substrates (Dzhafarov et al., 2004; DeLouise, 2004), electrolyte-insulator-semiconductor capacitor (EISCAP) based on silicon and PS for detecting different organic materials.

Another important characteristic of PS is the ability to tailor the material morphology for the desired applications. Fine control can be achieved by specifying the etching parameters so that micropores with different pore sizes can be tailored according to the condition required. Sometimes, it is also important to produce pores of graded size on the same substrate to achieve multiple targets sensing capability on the same chip. Graded morphology is the key to multiple gas/vapor sensing capability within the same array and the possibility of an 'e-nose'. A compact and sensitive PS-based electronic nose could bring greater reliability and repeatability into the professional sensing of food and wine (Marsh, 2002).

5.1 Optoelectronic applications

5.1.1 LEDs

The first publication on the formation of the electro-luminescent devices based on porous silicon was made by Richter et al. (Richter et al., 1991) and later by Koyama and Koshida (Koshida & Koyama, 1992). It is no doubt that silicon has a great importance in micro electronics integration technology. But Si is an indirect band gap semiconductor with very poor emission property. Although the radiative recombination exists in Si the quantum efficiency at room temperature is very low. In contrast, the discovery of the visible photoluminescence in porous silicon made it an interesting material for optoelectronic application. Steiner et al. (Steiner et al., 1993) introduced LEDs with porous p-n contact with improved efficiency. However these samples are suffering from poor stability problem while working in the open environment. But the environmental stability of LEDs is much improved when the pulsed mode of operation is used. Lazarouk et al. (Lazarouk et al., 1994) reported the formation of very stable Al/PS LEDs. The diodes emit white light under the reverse bias, possibly due to the excitation of surface plasmons in oxide near the edges of Al metallization stripes where the maximum local electric field is concentrated. In spite of the fact that there is an essential progress in the fabrication of porous silicon LEDs further work is necessary to improve their stability, quantum efficiency and speed.

5.1.2 Photodetectors

Porous silicon photoconductors are commonly fabricated by depositing aluminium film on top of oxidized porous silicon structure. The passivation of the surface by oxidation could improve the external quantum efficiency of a porous silicon photodiode (Tsai, 1993). Porous silicon also can be used as anti-reflecting coating for p-n photocells because of its reduced reflectivity of incident light from its surface. As suggested by Krueger et al. (Krueger et al. 1997) multilayer PS structures could be used as selectively absorptive filters to modify the spectral sensitivity of photo detectors.

5.1.3 Porous silicon solar cell

Solar cell converts solar radiation into electricity by photovoltaic effect. High optical absorption and low carrier recombination are two necessary conditions for efficient power conversion in a solar cell.

For the last two decades there is a steady growth of 15-30 % in the photovoltaic market and it is expected to increase more. However, the cost of photovoltaic energy source is still very high than the conventional energy sources. This cost can be reduced by high volume of production, reducing the material cost and improving the efficiencies.

The 90% of the solar cells are fabricated from crystalline silicon. But silicon is an indirect band gap semiconductor and its optical adsorption coefficient is also relatively low. So in thin film silicon light absorption will be much less. Therefore, the cost of silicon wafer becomes the 40% of its final module. Recently there is a huge shortage of silicon wafer in the photovoltaic market.

The nanocrystalline porous silicon thin film, on the other hand, has relatively high optical absorption coefficient. Therefore, using a thin film of porous silicon, the efficiency of a solar cell can be improved to a large extent as well as the shortage of silicon can also be avoided. Actually, a porous silicon coating reduces the reflectance and improves the light absorbance in the useful photovoltaic spectral range. Indeed, the effectiveness of the porous layer as the anti reflecting coating of the solar cell is already confirmed (Strehle et al. 1997). In tandem solar cell structure the use of micro porous silicon as an active element on a non degenerate p-type crystalline silicon has been reported. Porous silicon photovoltaic device was also fabricated by anodization of crystalline silicon as reported in the literature.

5.2 Biological applications of porous silicon

The biological incompatibility of Si material with living organisms is well known. But unlike bulk Si porous silicon becomes biologically active and restorable as demonstrated by Canham. Further research has shown that the porous Si may become an important biomaterial and reliable interface between the Si integrated circuit and the biological ambient. Bayliss et al. (Bayliss et al., 1997) reported that the nanocrystalline Si could be used as growth supports for cell cultures. Application of porous silicon in biological sensing is based on the immobilization of specific bio molecules at its surface that register changes in electrical and optical properties of PS as a result of their interaction with the biological complexes to be detected. Significant quenching of photoluminescence from PS as a result of antigen-antibody interaction is reported by Starodub (Starodub et al. 1996). Lin and co-workers (Lin et al., 1996, 1997) worked on the displacement of interference fringes in optical absorption or in luminescence spectra of porous silicon thin films for the absorption of chemical or biological molecules at the pore walls.

Silicon nanoparticles and porous silicon have several valuable biological properties e.g. biocompatibility, biodegradation capability, and high penetration power. Since the silicon nanoparticles can increase the permeability of cellular membranes, high doses of the pharmaceutical substances can be bound with the particles. Silicon nanoparticles can softly remove bacterial dental plaque without affecting the enamel and therefore can be used as a toothpaste additive. The silicon nanoparticles/porous silicon is considered as a fine preservative in food products because they can inhibit the development of pathogenic microorganisms. So, the introduction of silicon nanoparticles into the organism can be a novel idea. In fact, it is a subject of active research in many laboratories of the world. The properties of polycrystalline or porous silicon nanoparticles are also being explored in the regime of cancer research. The silicon nanoparticles bound with medicinal substances are added into the nutrient medium where the cells of human larynx tumour or mouse fibroblast cells are being cultivated. Russian researchers found that the nanoparticles in concentrations over three mg per ml hinder the growth of both normal and tumor cells. Porous silicon particles are more effective than polycrystalline silicon for this purpose.

5.3 Porous silicon pressure sensor

Pressure sensors are widely used in automobiles, robotics, space, and process industries, in addition to VLSI and biomedical applications. However, the commonly used metal strain gauges and capacitive manometers suffer from low sensitivity and bulky size and so they are not very suitable for sophisticated pressure sensing applications.

To improve the pressure sensor technology silicon can be used as a high precision, high strength, and high reliability mechanical material (Peterson, 1982). It can be micromachined to form various mechanical microstructures like diaphragm, cantilevers, nozzles and grooves and can also be readily integrated with the signal-processing unit. However such sensors suffer from low sensitivity, which makes them incompetent for low-pressure applications. The use of nanocrystalline silicon as an active material improves the performance of pressure sensors without considerably increasing the cost and complexity of fabrication. It has been observed that nanocrystalline porous silicon has the potential for improving the performance of the pressure sensors due to its increased piezoresistive coefficient of about 54.8% (Toriyama et al., 2002). Tailoring the dimensions of the nanocrystallites, which depends on the formation parameters, may modify the performance of the nanocrystalline porous silicon pressure sensor.

Reports are available (Pramanik & Saha, 2006a, 2006b) on the response of the porous silicon membrane under pressure for possible improvement of piezoresistive coefficient due to quantum confinement in the nanocrystalline structure of porous silicon. In fact, there is a change in the band structure of porous silicon induced by pressure and it affects the piezoresistive coefficient.

5.4 Porous silicon gas sensor

Porous silicon is one of the most promising materials in the field of gas sensor technology. It can be used in gas sensors either as an active or a passive layer for gas sensing.

For passive application, the PS layer acts as the heat isolator or sacrificial layer in the hotplate technology (Fürjes et al., 2004). The low power consumption and the short thermal transient times are the remarkable advantages of using porous silicon for thermally isolated micro hotplates. Additionally, due to its very high surface to volume ratio the sacrificial PS layer can be quickly and perfectly etched away.

For the active application of PS, it acts as the gas sensor layer with electrical, optical or thermal readout possibility. A simple cheap gas detectors that are super-sensitive, could be based on resistive PS elements (Pancheri et al., 2003). Researchers at the University of Brescia, have patented a technique using a porous silicon membrane on alumina substrate which could sense NO₂ as low as 100 parts per billion (ppb) at room temperature using low power and with a minimum interference from the contaminant organic vapors (Baratto et al., 2000).

Recently, a conductometric porous silicon gas sensor was used for rapid and reversible detection of gas analyte like CO (<5 ppm), NO_x (<1 ppm), SO₂ (<1 ppm) and NH₃ (500 ppb) (Lewis et al. 2005). A hybrid nano porous layer on macro porous silicon was used for the sensor study. To enhance the sensor performance a thin layer of gold or tin oxide nanostructured framework was developed on the PS surface by the electroless deposition of Au or Sn.

There are few reports on PS-Si structures as resistor type ethanol (Han et al., 2001), NO₂, organic vapour (Salgado et al., 2006) and H₂ (Rahimi & Irajizad, 2006) sensors. Seals and Gole (Seals et al., 2002) reported a PS based resistor type gas sensor for the detection of HCl, NH₃, and NO at 10 ppm level. But the full explanations of the sensor operations and theoretical interpretations were not discussed. However, Green et al. (Green & Kathirgamanathan, 2002) tried to explain the gas sensitivity of the PS-Si layered structure with parallel electrodes. Luongo and co-workers (Luongo et al., 2005) reported on a Pd doped PS, as a resistor type sensor for H₂ detection at room temperature. The basis of their sensor operation is the volume change of the Pd particles dispersed on porous silicon layer leading to a reduction in the layer impedance due to closer contact with each other. Further, a study on the same structure was carried out by (Sekhar et al., 2007) to find out the influence of anodization current density and etching time during PS formation on the response time and stability of Pd doped sensors. They also investigated the role of catalyst thickness on the sensor response.

Barillaro et al (Barillaro et al., 2005) reported a field-effect transistor like structure for gas sensing. As the floating gate controls the resistor value by modulating the interface potential barrier the PS resistance is not involved in the measurement, thus avoiding the contact problems.

There are some contact free methods (vibrating capacitor and surface photo voltage (SPV) measurements) to measure the surface and interface potentials and potential barriers. The vibrating capacitor has long been used for investigating semiconductor gas sensor surfaces (Mizsei, 2005; Souteyrand et al. 1995; Nicolas et al. 1997). This simple and exact method is sensitive to the contact potential difference (CPD) between a vibrating reference electrode and the surface to be investigated. An attempt was made to use PS-Si interface as a sensor structure together with vibrating capacitor readout (Polishchuk et al., 1998). An amorphous silicon on silicon structure, similar to the PS-Si system was reported for alcohol sensor (Sueva et al., 2002). Zhang et al. (Zhang et al., 2000) reported NO_x sensor with a Pd-Pt/PS/Al (MIS) structure with higher response than Pd-Pt/Si/Al configuration but with longer response time. V.G. Litovchenko and co workers (Litovchenko et al., 2004) studied the mechanism of hydrogen, oxygen and humidity sensing using Cu-Pd/PS/Si structures. They coated polymer film on the PS surface and studied the chemisorptions of the gas molecules. An attempt was also made to theoretically interpret the mechanism using an energy band diagram of Schottky like structure. There is a report (Kwok et al., 1999) on PS based Schottky diode sensor with Al electrode to sense the volatile organic compounds. L

pedrero et al. (Pedrero et al., 2004) reported on PdO/PS structure for sensing ammonia and other reducing gases.

As already mentioned instability is the most important problem related to porous silicon. As a chemically active high surface/volume ratio material it can be oxidized easily. Because of this chemical instability the physical properties of PS may change with time. However, the oxidized PS may be more stable and may contain less interface states responsible for the Fermi-level pinning. The oxygen adsorption may also result in an increase of conductance (Khoshnevis et al., 2006).

The authors reported porous silicon based room temperature hydrogen sensor (Kanungo et al., 2009b). The Metal-Insulator-Semiconductor (MIS) sensors were fabricated using both unmodified and surface modified porous silicon. Pd-Ag (26%) was chosen as the top noble metal electrode to fabricate the Pd-Ag/PS/Si/Al sensor structure. The junctions were characterized by I-V studies and were confirmed to behave as Schottky devices. They were subsequently used for hydrogen sensing at room temperature. At higher temperatures the junction deteriorated most probably due to the damage of PS surface. The modified sensors showed improvements over the unmodified samples in terms of response, time of response, time of recovery and stability as shown in the Table 5. The superior performance was observed for Pd modified sensors showing 84% response, 8 sec response time and 207 sec recovery time on exposure to 1% hydrogen in nitrogen carrier gas.

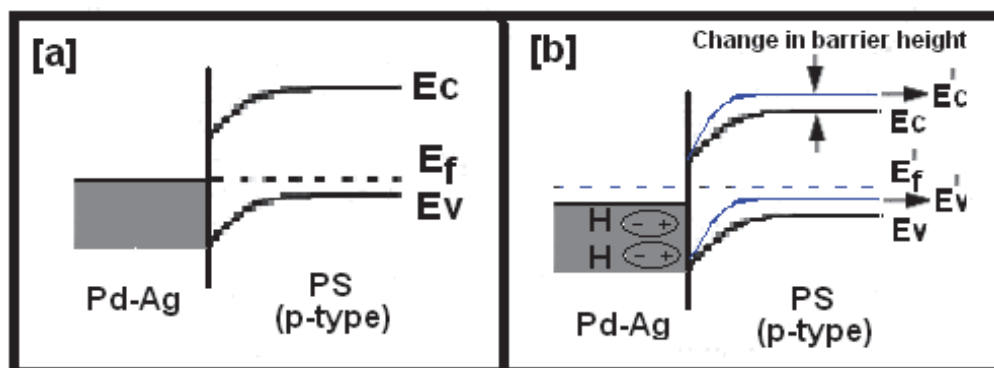

Fig. 13. Band diagram (not to scale) of Pd-Ag/PS junction (a) in absence and (b) in presence of hydrogen. A decrease in metal work function due to the formation of a dipole layer at the interface by the diffused hydrogen increases the barrier height at the metal / PS (p-type) junction.

The mechanism of hydrogen sensing was attributed to the dipole formation at the metal-PS interface in presence of the reducing gas that decreases the work function of the metal. As a result, the Schottky barrier height increases for the metal/p-type semiconductor junction and reduces the current through the noble metal/PS junctions (Fig. 13).

The modified samples improved the gas response behaviour after the formation of dispersed metal islands that passivate the PS surface and catalyze the dissociative adsorption of more hydrogen molecules. The defect free interface further helps in producing strong dipole during hydrogen sensing. Our study confirms Pd metal as the most effective modifier of PS surface for the superior performance of the Pd-Ag/PS/p-Si/Al hydrogen sensors.

The porosity of the PS was varied from 40% to 65% to study the effect of porosity on hydrogen sensor performance (Kanungo et al., 2010b). Both unmodified and Pd modified porous silicon sensors of different porosity were characterized for gas sensing. For

unmodified sensors gas response increased with increasing porosity and finally got saturated. On the other hand, the Pd modified sensors showed improvement in gas response with increasing porosity up to 55% and then deteriorated (Table 6). The structural characteristics of the Pd modified sensors by EDAX line scan analysis revealed that the incorporation of metal islands increased with the increasing porosity. The gas response depends on the effective surface area of the dispersed Pd, which increases with increasing porosity. But further enhancement in metal deposition (above 55% porosity in this case), may reduce the effective surface area of the dispersed Pd (Yamazoe, 1991). As a result the decomposition of the hydrogen molecule to atomic hydrogen on the surface of the catalytic Pd islands during gas sensing also decreases. Possibly for this reason the gas response behaviour decreases with higher porosity PS, higher than 55% in the present investigation.

Metal used	Biasing voltage (V)	Max response (%)	Response time (Sec)	Recovery time (Sec)
Unmodified	0.6	58	120	1055
Pd	0.2	84	8	207
	0.6	76	11	219
Ru	0.5	64	35	689
Pt	0.6	61	106	1020

Table 5. Response, response time and recovery time for unmodified and modified porous silicon hydrogen sensors in 1% hydrogen in nitrogen as carrier gas at room temperature.

Porosity of the sample (%)	Unmodified PS Biasing voltage=0.6V Temperature 27°C			Pd Modified PS Biasing voltage=0.2V Temperature 27°C		
	Response (%)	Response Time (Sec)	Recovery Time (Sec)	Response (%)	Response Time (Sec)	Recovery Time (Sec)
40	42	169	1176	66	54	318
45	47	147	1132	72	23	276
50	53	132	1084	79	14	231
55	58	120	1055	84	8	207
60	59	114	1047	77	17	249
65	60	108	1033	68	29	286

Table 6. Response, response time and recovery time for unmodified and modified porous silicon hydrogen sensors with different porosities, in presence of 1% hydrogen in nitrogen and at 27°C.

6. Factors related to the improved performance of porous silicon devices

The performance of photonic and gas sensor devices is related to the grain size, porosity and thickness of the porous thin film. The use of catalytic metal electrode and the modification of the sensor surface are other two important factors for an improved chemical sensor.

6.1 Grain size

For a nano crystalline material the fraction of atoms at the grain boundary increases due to decrease in crystal size. As a result the grain boundaries contain a high density of defects like vacancies and dangling bonds that can play an important role in the transport properties of electrons of nano materials. As the grain boundaries are metastable states they want to reduce their energy either by exchange of electrons or by sharing the electrons with other atoms. Hence the surface reactivity (or chemical reactivity) increases. Different models are proposed to explain the dependence of crystal size and the high sensitivity of nanocrystalline sensors and it was found that the sensitivity is proportional to $1/D$, where D is the average grain size. Further, nanocrystalline structure can reduce the operating temperature of the sensors (Rothschild & Komen, 2004).

6.2 Porosity and thickness of the porous thin films

Dependence of PS solar cell parameters on its microstructure i.e. the initial porosities and thickness are reported in the literature (Menna & Tsuo, 1997).

For a porous silicon pressure sensor, the change in resistance on application of pressure has been reported to depend on the variation of porosities and thickness of the porous silicon layer (Pramanik & Saha, 2006a, 2006b).

In a compact sensing layer, gases cannot penetrate into the layers and the gas sensing reaction is confined to the surface. In case of the porous films, gases can access the entire volume of the sensing layer and therefore the gas sensing reactions can take place at the surface of the individual grain, at the grain boundaries and at the interface between grains and electrodes. Therefore, porous layer is more suitable for gas sensing as compared to compact ones (Basu et al., 2005; Xu et al., 1991; Tiemann, 2007; Sakai et al., 2001; Basu et al., 2008). The thickness of a thin film plays a great role in the sensor response. F. H. Babaei et al. (Babaei et al., 2003) proposed a model to establish a general mathematical relationship between the steady state sensitivity of the sensor and the thickness of the sensitive film used. It was shown that the sensitivity drops exponentially as the thickness of the sensitive film increases. On the other hand, some groups reported that for certain combinations of the structural parameters like porosity; cracks etc, the gas sensitivity of the sensors could increase with thickness. For porous silicon all these parameters can be controlled during its preparation.

6.3 Effect of noble metal catalyst as contact electrode

The performance of chemical sensor can be improved to a large extent by incorporation of noble catalytic metals on the porous layer. It increases the rate of chemical reactions. In fact, it does not change the free energy of the reactions but lowers the activation energy.

There are quite a few reports of the applications of nanoporous noble metal thin films as the electrode contact for gas sensing (Ding et al., 2006; Lundstrom et al., 2007). The nanoporous noble metal thin films have significant role on hydrogen sensing. The nano holes can provide much more surface area, which in turn helps in rapid adsorption/desorption processes and diffusion into the porous thin film interface.

Pure Pd is a good catalyst for sensing hydrogen, methane and other reducing gases (Armgarth & Nylander, 1982). But there are some drawbacks associated with the use of pure Pd metal due to blister formation because of the irreversible transition from the α phase of palladium to the β phase hydride at low H_2 and at 300 K (Wang & Feng, 2007; Hughes et al.,

1987). In addition, the response time more than 10 min for Pd-sensors is too slow to allow real-time monitoring of flowing gas streams. To overcome these problems Pd is alloyed to a second metal (Ag at 26 %) and is used for H₂ or hydrocarbon sensing. Pd-Ag alloy thin film has some special properties for use in gas sensors and they are reported as follows:

The rate of hydride formation is very low for Pd-Ag alloy compared to pure Pd.

Since the solubility of hydrogen is favorable up to 30 % of Ag in Pd Ag atom does not hinder the diffusion of hydrogen.

The OH formation barrier energy is higher in presence of Pd-Ag alloy.

The mechanical properties of polycrystalline Pd-Ag alloy are better than Pd.

6.4 Effect of noble metal dispersion on the surface of porous silicon

The sensitivity of a semiconductor sensor could be improved by surface modification through highly dispersed catalytic platinum group metals like Pd, Ru and Pt (Vaishampayan et al., 2008; Cabot et al., 2002). These additives act as activators for the surface reactions (Zhua et al., 2005; Romyantseva et al., 2008).

F. Volkenstein (Volkenstein, 1960) provides an idea of how the adsorbate affects the overall band structure of the modified matrix. Additionally, the chemical nature of the modifier and its reactivity in acid–base or redox reactions may play an important role (Korotcenkov, 2005). The dispersed catalyst actually activates the spillover process. Therefore, the functional parameters such as sensitivity, response time, recovery time and selectivity improve significantly through surface modification by noble metals.

It was found from the literature that Pd modification is very effective to reduce the operating temperature and to achieve a high response of a gas sensor. Depending on the factors like grain size, porosity and the thickness of the thin film, porous silicon can appreciably be used as a gas sensor operating at low temperature (Mizsei, 2007).

Improved gas response behaviour of a palladium doped porous silicon based hydrogen sensor was reported by Polishchuk et al. (Polishchuk et al. 1998). C. Tsamis and co workers (Tsamis et al., 2002) reported on the catalytic oxidation of hydrogen to water on Pd doped porous silicon. K. Luongo and coworkers. (Luongo et al., 2005) reported an impedance based room temperature H₂ sensor using Pd doped nano porous silicon surface. P K Sekhar and co workers (Sekhar et al, 2007) tried to find out the influence of anodization current density and etching time during PS formation on the response time and stability of Pd doped sensors. They also investigated the role of catalyst thickness on the sensor response. Rahimi et al. (Rahimi et al., 2006) studied Pd growth on PS by electroless plating and the response to hydrogen for both lateral and sandwich structures using gold contact.

As already mentioned in section 5.4 the authors also worked on noble metal modification of porous silicon and development of room temperature hydrogen sensors. The modified sensors showed significant improvements over the unmodified ones in terms of sensor response, time of response, time of recovery and long term stability.

7. Summary and conclusion

In this chapter the preparation of nanocrystalline porous silicon (PS) by electrochemical anodization has been described and different models have been mentioned to improve the quality of PS film. The mechanism of porous silicon formation has also been cited. Structural, chemical, optical & electrical properties of porous silicon have been mentioned. Optical, optoelectronic, biological and chemical gas sensor applications of PS have been

discussed. The merits and demerits of reported work on porous silicon have been critically discussed. The factors that make porous silicon a special material for some specific applications are illustrated. The common problem of instability of nanocrystalline porous silicon surface, related to the large density of surface states and recent approaches to stabilize the PS surface have been highlighted using the example of gas sensor applications. The mechanism of surface modification using noble metal ions has been clarified. The effect of porosity on the sensor parameters has also been explained with the specific example of hydrogen gas sensor studies.

In conclusion, the basic concepts of the importance of nanocrystalline silicon over crystalline silicon for recent applications in different areas of science & technology have been highlighted. The simple method of chemical surface modification using noble metal ions to stabilize porous silicon as demonstrated using hydrogen gas sensor devices needs special mention.

8. References

- Anderson, R.C., Muller, R.S. & Tobias, C.W. (1993) Chemical Surface Modification of Porous Silicon, *J. Electrochem. Soc. (USA)* Vol. 140, pp. 1393.
- Andersson, H.A., Thungstrom, G. & Nilsson, H. (2008) Electroless deposition and Silicidation of Ni contacts into p-type Porous Silicon. *J Porous Mater*, Vol. 15, pp. 335.
- Andsager, D., Hilliard, J. & Nayfeh, M.H. (1994) Behavior of porous silicon emission spectra during quenching by immersion in metal ion solutions, *Appl. Phys. Lett.* Vol. 64, pp. 1141.
- Angelescu, A. & Kleps, I. (1998) Metallic contacts on porous silicon layers. *IEEE Conf.* pp 447.
- Archer, M. Christophersen, M. & Fauchet, P.M. (2005) Electrical porous silicon chemical sensor for detection of organic solvents, *Sens. Actuators B* Vol.106, pp. 347.
- Archer, M. & Fauchet, P.M. (2003) Electrical Sensing of DNA hybridization in porous silicon layers. *Phys Stat Solidi A*, Vol.198, pp. 503.
- Armgarth, M. & Nylander, C. (1982) Blister formation in Pd gate MIS hydrogen sensors, *IEEE Electron Devices. Lett.* EDL Vol.3, pp. 384.
- Aroutiounian, V.M., Martirosyan, K. & Soukissian, P. (2004) Low reflectance of diamond-like carbon/porous silicon double layer antireflection coating for silicon solar cells. *J. Phys. D* 37, No.19, pp. L25.
- Astrova, E.V., Ratnikov, V.V., Remenyuk, A.D. & Shul'pina I.L. (2002) Starins and crystal lattice defects arising in macroporous silicon under oxidation. *Semiconductors* Vol.36, pp. 1033.
- Astrova, E.V., Voronkov, V.B., Remenyuk, A.D. & Shuman, V.B. (1999) Variation of the parameters and composition of thin films of porous silicon as a result of oxidation: ellipsometric studies. *Semiconductors* Vol. 33, No.10, pp. 1149-1155.
- Babaei, F.H. & Orvatinia, M., (2003) Analysis of thickness dependence of the sensitivity in thin film resistive gas sensors, *Sensors and Actuators, B*, Vol. 89, pp. 256.
- Baratto, C., Sberveglieri, G., Comini, E., Faglia, G., Benussi, G., La Ferrara, V., Quercia, L., Di Francia, G., Guidi, V., Vincenzi, D., Boscarino, D. & Rigato, V. (2000) Gold-catalysed porous silicon for NO_x sensing, *Sens. Actuators B*, Vol. 68, pp. 74.

- Barillaro, G., Diligenti, A., Marola, G. & Strambini, L.M. (2005) A silicon crystalline resistor with an adsorbing porous layer as gas sensor, *Sens. Actuators, B*, Vol. 105, pp. 278.
- Barillaro, G., Nannini, A. & Pieri, F.. (2003) APSFET : a new, porous silicon based gas sensing devices, *Sensors. Actuators, B*, Vol.93, pp. 263.
- Barla, K., Herino, R., Bomchil, G., Pfiser, J.C. & Freund, A. (1984) Determination of lattice parameter and elastic properties of porous silicon by X-ray diffraction. *J. Cryst. Growth* Vol. 68, No. 3, pp. 727-732.
- Basu, P. K., Bhattachayya, P., Saha, N., Saha H. & Basu, S. (2008) The superior performance of the electrochemically grown ZnO thin films as methane sensor, *Sensors and Actuators, B*, Vol. 133, pp. 357.
- Basu, S. & Hazra, S.K. ZnO (2005) p-n homojunctions for hydrogen gas sensors at elevated temperature, *Asian Journal of Physics*, Vol.14, pp. 65.
- Bayliss, S.C., Harris, P.J., Buckberry, L.D. & Rousseau, C. (1997) *Mater Sci Lett*. Vol. 16, pp.737
- Beale, M. I. J., Benjamin, J. D., Uren, M. J., Chew, N. G. & Cullis, A. G. (1986) The formation of porous silicon by chemical stain etches, *J. Cryst. Growth* Vol. 75, pp. 408.
- Beale, M.I.J., Chew, N.G., Uren, M.J., Cullis, A.G. & Benjamin, J.D. (1985) *Appl Phys Lett*, Vol.46, pp. 86.
- Beckmann, K.H. (1965) Investigation of the chemical properties of stain films on silicon by means of infrared spectroscopy. *Surface Science*, Vol.3, pp. 314.
- Behren J.V. & Fauchet P.M. (1997) Absorption coefficient of porous silicon. In: *Properties of porous silicon*. Canham L (ed), pp. 229-233, INSPEC, London.
- Bellet, D. (1997) Drying of porous silicon. In: *Properties of porous silicon*. Canham L (ed): pp. 38-43 and 127-131. INSPEC, London
- Ben-Chroin, M. (1997) Resistivity of porous silicon. In: *Properties of porous silicon*. Canham L (ed) pp. 38-43 and 165-175, INSPEC, London.
- Bisi O, Ossicini S & Pavese L (2000) Porous silicon: a quantum sponge structure for silicon based optoelectronics. *Surface Science Rep*. Vol.38, pp.1-126.
- Bondarenko, V.P. & Yakovtseva, V.A. (1997) Microelectronic applications of porous silicon. In: *Properties of porous silicon*. L. Canham (ed), pp. 343, INSPEC, London,
- Bondarenko, V.P. & Yakovtseva V.A. (1997) Optoelectronic applications of porous silicon. In: *Properties of porous silicon*. L. Canham (ed), pp. 356, INSPEC, London,
- Bsiesy, A., Vial, J.C., Gaspard, F., Herino, R., Ligeon, M., Muller, F., Romestain, R., Wasiela, A., Halimaoui, A. & Bomchil, G., (1991) Photoluminescence of high porosity and of electrochemically oxidized porous silicon layers, *Surf.Sci. (Netherlands)* Vol. 254, pp. 195
- Cabot, A., Vila, A. & Morante, J.R. (2002) Analysis of the catalytic activity and electrical characteristics of different modified SnO₂ layers for gas sensors, *Sensors and Actuators, B*, Vol.84, pp. 12.
- Canham, L, Editor (1997a.) *Properties of porous silicon*, INSPEC - The Institution of Electrical Engineers ; United Kingdom.
- Canham, L.T. (1997b) Biomedical applications of porous silicon. In: *Properties of porous silicon*. L. Canham (ed), pp. 371, INSPEC, London,.
- Canham, L.T. (1997c) Storage of porous silicon. In: *Properties of porous silicon*. L. Canham (ed), pp. 44, INSPEC, London.
- Canham, L.T. (1997d) Visible photoluminescence from porous silicon. In: *Properties of porous silicon*. L. Canham (ed), pp. 249, INSPEC, London,.

- Canham, L.T., Houlton, M.R., Leong, W.Y., Pickering, C. & Keen, J.M. (1991) Atmospheric impregnation of porous silicon at room temperature. *J. Appl. Phys.* Vol.70, pp. 422.
- Canham, L.T. (1990) Silicon quantum wire array fabricated by electrochemical and chemical dissolution of wafers, *Appl Phys Lett*, Vol 57, No 10, pp 1046-1048
- Cullis, A.G. & Canham, L.T. (1991) Visible light emission due to quantum size effects in highly porous crystalline silicon, *Nature*, Vol 353, pp 335-338
- Cullis, A.G., Canham, L.T. & Calcott, P.D.J. (1997) The structural and luminescence properties of porous silicon, *J App Phys*, Vol 82, No 3, pp 909-965
- DeLouise, L.A. & Miller, B.L. (2004) Quantitative assessment of enzyme immobilization capacity in porous silicon. *Anal. Chem.* Vol.76, No.23, pp. 6915.
- Deresmes, D., Marissael, V., Stievenard, D. & Ortega, C., (1995) Electrical behaviour of aluminium-porous silicon junctions, *Thin Solid Films*.Vol. 255, pp. 258.
- Dimitrov, D.B. (1995) Current-voltage characteristics of porous silicon layer. *Physical Review B*, Vol. 51, pp. 1562.
- Ding, D. Chen, Z; Lu, C., (2006) Hydrogen sensing of nanoporous palladium films supported by anodic aluminum oxides, *Sensors and Actuators, B* , Vol.120, pp. 182.
- Duttagupta, S.P., Chen, X.L., Jenekhe, S.A. & Fauchet, P.M. (1997) Microhardness of porous silicon films and composites. *Solid State Comm.* Vol.101, No. 1, pp. 33-37.
- Dzhafarov, T.D., Oruc, C. & Aydin, S. (2004) Humidity-voltaic characteristics of Au - porous silicon interfaces. *J. Phys. D* Vol.37, pp. 404.
- Foell, H., Christophersen, M., Carstensen, J. & Hasse, G. (2002) Formation and application of porous silicon, *Materials Science and Engineering R* Vol. 39, pp. 93.
- Fuchs, H.D., Stutzmann, M., Brandt, M.S., Rosenbauer, M., Weber, J. & Cardona, M. (1992) Visible luminescence from porous silicon and siloxene, *Physica Scripta*, Vol T45, pp 309-313
- Fürjes, P., Dücső, Cs., Ádám, M., Zettner, J. & Bársony, I. (2004) Thermal characterisation of micro-hotplates used in sensor structures, *Superlattices Microstruct.* Vol. 35, pp. 455.
- Green, S. Kathirgamanathan, P. (2002) Effect of oxygen on the surface conductance of porous silicon: towards room temperature sensor applications *Mater. Lett.* Vol. 52, pp. 106.
- Halimaoui, A., Oules, C., Bomchill, G., Bsiesy, A., Gaspard, F., Herino, R., Ligeon, M. & Muller, F. (1991) Electroluminescence in the visible range during anodic oxidation of porous silicon films. *Appl. Phys. Lett.* Vol.59, No.3, pp. 304-306.
- Hamilton, B. (1995) Porous silicon, *Semicond Sci Technol*, Vol 10, pp 1187-1207
- Hossain, S.M., Chakraborty, S., Dutta, S.K., Das, J. & Saha, H. (2000) Stability in photoluminescence of porous silicon. *J. Lumin.*, Vol.91, pp. 195-202.
- Hughes, R.C., Schubert, W.K., Zipperian T.E., Rodriguez J.L. & Plut, T.A. (1987) Thin film palladium and shiver alloys and layers for metalinsulator-semiconductor sensors, *J. Appl. Phys.*, Vol.62, pp. 1074.
- Hummel R.E. & Chang S S., (1992) Novel technique for preparing porous silicon, *Appl. Phys. Lett.* Vol. 61, pp. 1965.
- Ito, T., Yamama, A., Hiraki, A. & Satou, M. (1989) Silicidation of porous silicon and its application for the fabrication of a buried metal layer. *Appl. Surf. Sci.* Vol. 41-42, pp. 301.

- Jeske, M., Schultze, J.W., Thonissen, M., Munder, v (1995) Electrodeposition of metals into porous silicon. *Thin solid films*, Vol.255, pp. 63-66.
- Kang Y, Jorne J. (1993) *J Electrochem Soc* Vol.140:2258.
- Kanungo, J., Pramanik, C., Bandopadhyay, S., Gangopadhyay, U., Das, L., Saha, H. & Gettens, R.T.T. (2006) Improved Contacts On Porous Silicon Layer By Electroless Nickel Plating and Copper Thickening, *Semicond Sci and Technol.*, Vol. 21, pp. 964.
- Kanungo, J., Maji, S., Saha, H. & Basu, S. (2009a) Stable Aluminium Ohmic Contact to Surface Modified Porous Silicon. *Solid-State Electronics* Vol. 53, pp. 663-668.
- Kanungo, J., Saha H. & Basu, S. (2009b) Room temperature Metal-Insulator -Semiconductor (MIS) Hydrogen Sensors Based On Chemically Surface Modified Porous Silicon. *Sensors and Actuators B*, Vol.140, pp. 65-72.
- Kanungo, J., Maji, S., Mandal, A.K., Sen, S., Bontempi, E., Balamurugan, A.K., Tyagi, A.K., Uvdal, K., Sinha, S., Saha H. and Basu. S. (2010a) Investigations on the surface morphology of the modified porous silicon using noble metal ions. *J. of Applied Surface Science*, Vol.256, pp. 4231- 4240.
- Kanungo, J., Saha, H. & Basu, S. (2010b) Effect of porosity on the performance of surface modified porous silicon hydrogen sensors. *Sensors and Actuators B*, Vol.147, pp. 145-151.
- Karacali, T., Cakmak, B. & Efeoglu, H. (2003) Aging of porous silicon and the origin of blue shift. *Optics Express*, Vol.11, pp. 1237-1242.
- Khoshnevis, S., Dariani, R.S., Azim-Araghi, M.E., Bayindir, Z. & Robbie, K. (2006) Observation of oxygen gas effect on porous silicon-based sensors, *Thin Solid Films*, Vol. 515, pp. 2650.
- Koch, F. (1993) Models and mechanisms for the luminescence of porous Si, *Mat Res Soc Symp Proc*, Vol 298, pp 319-329
- Korotcenkov, G. (2005) Gas response control through structural and chemical modification of metal oxide films: state of the art and approaches, *Sensors and Actuators, B*, Vol.107, pp. 209.
- Koshida, N. & Koyama, H. (1992) *Appl Phys Lett.*, Vol.60, pp. 347.
- Krueger, M., Marso, M., Berger, M.G., Thonissen, M., Billat, S., Loo, R., Reetz, W., Luth, H., Hilbrich, S., Arensfischer, R. & Grosse, P. (1997) *Thin Solid Films*, Vol. 297, pp. 241.
- Kwok, W.M., Bow, Y.C., Chan, W.Y., Poon, M.C., Han, P.G. & Wong, H. 1999 Study of porous silicon gas sensor, Electron devices meeting, 1999. Proceedings., *IEEE Hong Kong*, June Vol.26,1999.
- Lang, W. (1997) Thermal conductivity of porous silicon. In: *Properties of porous silicon*. Canham L (ed) pp. 128-141, INSPEC, London
- Lauerhaas, J.M. & Sailor, M.J. (1993) The Effects of Halogen Exposure on the Photoluminescence of Porous Silicon. *Mat. Res. Soc. Symp. Proc. (USA)*, Vol. 298, pp. 259.
- Lazarouk, S., Baranov, I., Maiello, G., Proverbio, E., deCesare, G. & Ferrari, A. (1994) *J Electrochem Soc.*, Vol.141, pp. 2556.
- Lees, I.N., Lin, H., Canaria, C.A., Gurtner, C., Sailor, M.J. & Miskelly, G.M. (2003) Chemical stability of porous silicon surfaces electrochemically modified with functional alkyl species, *Langmuir*, Vol. 19, pp. 9812.
- Lewis, S.E., DeBoer, J.R., Gole, J.L. & Hesketh, P.J. (2005) Sensitive selective and analytical improvements to a porous silicon gas sensor, *Sens. Actuators, B*, Vol. 110, pp. 54.

- Lin, J., Yao, GQ., Duan, JQ. & Qin, GG. (1996) Ultraviolet light emission from oxidized porous silicon, *Solid State Communications*, Vol 97, No 3, pp 221-224
- Lin, VS., Motesharei, K., Dancil, KS., Sailor, MJ. & Ghadiri, MR. (1997) *Science*, Vol. 278, pp.840.
- Litovchenko, V.G., Gorbanyuk, T.I., Solntsev, V.S. & Evtukh, A.A. (2004) Mechanism of hydrogen, oxygen and humidity sensing by Cu/Pd-porous silicon-silicon structure, *Appl.Surf.Sci.* Vol. 234, pp. 262.
- Lockwood, DJ. Aers, GC., Allard, LB., Bryskieicz, B., Charbonneau, S., Houghton, DC., McCaffrey, JP. & Wang, A. (1992) Optical properties of porous silicon, *Can J Phys*, Vol 70, pp 1184-1193
- Lundstrom, I., Sundgren, H., Winquist, F., Eriksson, M., Rulcker, C.K. & Spetz, A.L (2007) Twenty-five years of field effect gas sensor research Linkoping, *Sensors and Actuators, B*, Vol.121, pp. 247
- Luongo, K., Sine, A. & Bhansali, S. (2005) Development of a highly sensitive porous Si-based hydrogen sensor using Pd nano-structures, *Sens. Actuators, B*, Vol. 111-112, pp. 125.
- Mandal, N.P., Sharma, A. & Agarwal, S.C. (2006) Improved stability of nanocrystalline porous silicon after coating with a polymer, *J.Appl.Phys.* Vol. 100, pp. 024308.
- Marsh, G. (2002) Porous silicon a useful imperfection, *Materials Today*, Vol.5, pp. 36.
- Martin-Palma, R.J., Perez-Rigueiro, J., Guerrero-Lemus, R., Moreno, J.d. & Martinez-Duart, J. (1999) Ageing of aluminium electrical contacts to porous silicon. *J Appl Phys.* Vol. 85, pp. 583.
- Memming, R. & Schwandt, G. (1966) Anodic Dissolution of Silicon in Hydrofluoric Acid Solutions, *Surf Sci.*, Vol.4, pp. 109.
- Menna, P Tsuo, S (1997) Solar Cells using porous silicon. In: *Properties of porous silicon*. Canham L (ed), pp.384-389, INSPEC, London.
- Mizsei, J. (2007) Gas sensor applications of porous Si layers, *Thin solid films*, Vol.515, pp. 8310.
- Mizsei, J. (2005) Vibrating capacitor method in the development of semiconductor gas sensors, *Thin Solid Films*, Vol. 490 17.
- Nakagawa, T., Koyama, H. & Koshida, N. (1996) Control of structure and optical anisotropy in porous Si by magnetic-field assisted anodization, *Appl. Phys. Lett.* Vol.69, pp. 3206.
- Nakajima, Y., Uchida, T., Toyama, H., Kojima, A., Gelloz, B. & Koshida, N. (2004) A solid-state multicolor light-emitting device based on ballistic electron excitation. *Jap. J. Appl. Phys. Part 1* Vol.43, No.4B, pp. 2076.
- Nicolas, D. Souteyrand, E. Martin, J.R. (1997) Gas sensor characterization through both contact potential difference and photopotential measurements, *Sens. Actuators, B*, Vol. 44, pp. 507.
- Pancheri, L., Oton, CJ., Gaburro, Z., Soncini, G. & Pavesi, L. (2003) Very sensitive porous silicon NO₂ sensor, *Sens. Actuators B*, Vol. 89, pp. 237.
- Parkhutik V (1999) Porous silicon - mechanism of growth and applications. *Solid-state Electron.* Vol.43, pp. 1121-1141.
- Parkhutik VP. & Shershulsky VI. (1992) *J Phys D, Appl Phys*, Vol.25, pp. 1258.

- Pavesi, L. & Dubos P, (1997) Random porous silicon multilayers application to distributed Bragg reflectors and interferential Fabry Perot filters. *Semicond Sci and Technol.*, Vol. 12, pp. 570.
- Pedrero, O.L., Pena-Sierra, R. & Romero Paredes, RG. 2004 Gas sensor based on porous silicon and palladium oxide clusters. *1st International conference on Electrical and Electronics Engineerin: (ICEEE): Acapulco, Mexico, September 8-10, 2004.*
- Perez, JM., Villalobos, J., McNeill, P., Prasad, J., Cheek, J., Kelber, J., Estrera, JP., Stevens, PD. & Glosser, R. (1992) Direct evidence for the amorphous-silicon phase in visible photoluminescent porous silicon, *Appl Phys Lett*, Vol 61, No 5, pp 563-565
- Peterson, K. (1982) Silicon as a mechanical material, *Proc. Of IEEE*, Vol.70, No.5, pp.420.
- Petit, D., Chazalviel, JN., Ozanam, F. & Devreux, F. (1997) Porous silicon structure studied by nuclear magnetic resonance. *Appl. Phys. Lett.* Vol.70, No. 2, pp. 191-193.
- Petrova, E.A., Bogoslovskaya, K.N., Balagurov, L.A. & Kochoradze, G.I. (2000) Room temperature oxidation of porous silicon in air. *Mater. Sci. Eng. B* Vol 69-70, pp. 152.
- Petrova-Koch V., Muschik, T., Kux, A., Meyer, B.K., Koch, F. & Lehmann, V., (1992) Rapid-thermal-oxidized porous Si–The superior photoluminescent Si, *Appl. Phys. Lett.*Vol. 61, pp. 943.
- Pickering, C., Beale, M.I.J., Robbins, D.J., Pearson, P.J. & Greef, R. (1984) Optical studies of the structure of porous silicon films formed in p-type degenerate and non-degenerate silicon. *J. Phys. C* Vol.17, pp. 6535.
- Pillai, SM., Xu, Z Y., Gal, M., Glaisher, R., Phillips, M. & Cockayoe, D. (1992) *Jpn. J. Appl. Phys.* Vol.31, , pp. L1702.
- Polishchuk, V., Souteyrand, E., Martin, J.R., Strikha, V.I. & Skryshevskya, V.A. (1998) A study of hydrogen detection with palladium modified porous silicon, *Anal. Chim. Acta*, Vol. 375, pp. 205.
- Pramanik, C. Islam, H. Saha, H. (2005) Design, fabrication, testing and simulation of porous silicon based smart MEMS pressure sensor. *IEEE Computer Society, 18th International Conference on VLSI'05* , pp. 235.
- Pramanik, C. & Saha H. (2006) Low pressure piezoresistive pressure sensors for biomedical applications”, *Materials and Manufacturing Processes*, Vol.21, No. 3, pp.233-238.
- Pramanik, C. & Saha, H. (2006) Piezoresistive pressure sensing by porous Silicon Membrane,*IEEE Sensors*, Vol.6, pp.301-309.
- Prokes, SM., Glembocki, OJ., Bermudez, VM., Kaplan, P., Friedersdorf, LE. & Searson, PC. (1992) SiH_x excitation – an alternative mechanism for porous Si photoluminescence, *Physical Review B*, Vol 45, No 23, pp 13788-13791
- Rahimi, F. & Irajizad, A. (2006) Effective factors on Pd growth on porous silicon by electroless-plating; response to hydrogen, *Sens. Actuator, B*, Vol. 115, pp. 164.
- Read, AJ., Needs, RJ., Nash, KJ., Canham, LT., Calcott, PDJ. & Qteish, A. (1992) First-principles calculation of the electronic properties of silicon quantum wires. *Phys. Rev. Lett.* Vol.69, No. 8, pp. 1232-1235.
- Richter, A., Steiner, P., Kozlowski, F. & Lang, W. (1991) *IEEE Electron Device Lett*, Vol.12, pp. 691.
- Rossi, A.M., Amato, G., Camarchia, V., Boarnio, L. & Borini, S., (2001) High-quality porous-silicon buried waveguides. *Appl. Phys. Lett.* Vol.78, No.20, pp. 3003.
- Rothschild, A. & Komen, Y. (2004) The effect of grain size on the sensitivity of nanocrystalline metal-oxide gas sensors, *J. Appl. Phys.*, Vol.95, pp. 6374.

- Rumyantseva, MN., Kovalenko, VV., Gas'kov, AM. & Pagnier, T. (2008) Metal-Oxide Based Nanocomposites as Materials for Gas Sensors, ISSN 1070-3632, *Russian Journal of General Chemistry*, Vol.78, pp. 1081.
- Sailor, M.J. (1997) Sensor applications of porous silicon. In: *Properties of porous silicon*. L. Canham (ed), pp. 364, INSPEC, London.
- Sakai, G., Baik, N.S., Miura, N. & Yamazoe, N. (2001) Gas sensing properties of tin oxide thin films fabricated from hydrothermally treated nanoparticles—dependence of CO and H₂ response on film thickness, *Sensors and Actuators, B*, Vol. 77, pp. 116.
- Samuel, BJ., Editor (2010) *Nanoporous Materials - Types, Properties and Uses*, Nova Scientific Publishers, Inc., New York.
- Seals, L., Tse, L.A., Hesketh, P.J. & Gole, J.L. (2002) Rapid, reversible, sensitive porous silicon gas sensor, *J. Appl. Phys.* Vol. 91, pp. 2519.
- Sekhar, P.K., Sine, A. & Bhansali, S. (2007) Effect of varying the nanostructured porous-Si process parameters on the performance of Pd-doped hydrogen sensor, *Sens. Actuators, B*, Vol. 127, pp. 74.
- Souteyrand, E., Nicolas, D., Queae, E. & Martin, J.R. (1995) Influence of surface modifications on semiconductor gas sensor behaviour, *Sens. Actuators, B*, Vol. 26, pp. 174.
- Starodub, NF., Fedorenko, LL., Starodub, VM., Dikij, SP. & Svectinikov, SV. (1996) *Sensors and Actuators*, Vol. 35-36, pp.44.
- Stathis, JH. & Kastner, MA. (1987) Time-resolved photoluminescence in amorphous-silicon dioxide, *Phys Rev B*, Vol 35, pp 2972-2979
- Steiner, P., Kozlowski, F. & Lang, W. (1993) *Appl Phys Lett.*, Vol.62, pp. 2700.
- Steiner, P., Kozlowski, F., Wielunski, M. & Lang, W. (1994) Enhanced Blue-Light Emission from an Indium-Treated Porous Silicon Device *Jpn.J.Appl.Phys.* Vol.33, pp. 6075.
- Stievenard, D. & Deresmes, D., (1995) Are electrical properties of an aluminium-orous silicon junction governed by dangling bonds, *Appl. Phys. Lett.*, Vol. 67, pp. 1570.
- Strehle, S., Sarti, D., Krotkus, A., Grigiras, K. & Levy-Clement, C. (1997) *Thin Solid Films*, Vol. 297, pp. 296-298.
- Takai, H. & Itoh, T. (1986) Porous silicon layers and its oxide for the silicon-on-insulator structure, *J. Appl. Phys.* Vol.60 pp. 222.
- Tiemann, M. (2007) Porous Metal Oxides as Gas Sensors, *Chemistry – A European Journal*, Vol.13, pp. 8376.
- Toriyama, T., Tanomoto, Y. & Sugiyama, S. (2002) Single crystal silicon nanowires piezoresistors for mechanical sensors, *IEEE Journal of MEMS*, Vol.11, No.5, pp. 605-611.
- Tsai, C., Li, KH., Campbell, JC. & Tasch, A. (1993) *Appl Phys Lett.*, Vol.62, pp. 2818.
- Tsai, C., Li, KH., Sarathy, J., Shih, S., Campbell, JC., Hance, BK., & White, JM. (1991) Thermal treatment studies of the photoluminescence intensity of porous silicon, *Appl Phys Lett*, Vol 59, No 22, pp2814-2816
- Tsamis, C., Tsoura, L., Nassiopoulou, A.G., Travlos, A., Salmas, C.E., Hatzilyberis, K.A. & Ndroutsopoulos, G.P. (2002) Hydrogen Catalytic Oxidation Reaction on Pd-Doped Porous Silicon, *IEEE Sensors Journal*, Vol.2, pp. 89.
- Turner, D.R. (1958) Electro polishing of Silicon in Hydrofluoric Acid Solutions, *J Electrochem Soc.*, Vol.105, pp.402-408.

- Ulhir, A. (1956) Electrolytic shaping of germanium and silicon, *Bell Syst. Tech. J.* Vol.35, pp. 333.
- Vaishampayan, MV., Deshmukh, RG. & Mulla, I.S. (2008) Influence of Pd doping on morphology and LPG response of SnO₂, *Sensors and Actuators, B*, Vol.131, pp. 665.
- Vasquez, RP., Fathauer, RW., George, T., Ksendzov, A. & Lin, TL. (1992) Electronic-structure of lightemitting porous Si, *Appl Phy Lett*, Vol. 60, No. 8, pp. 1004-1006
- Vasquez, RP., Madhukar, A. & Tanguay, JAR. (1985) Spectroscopic ellipsometry and X-ray photoelectron-spectroscopy studies of the annealing behaviour of amorphous Si produced by Si ion-implantation, *J Appl Phys*, Vol 58, No 6, pp 2337-2342
- Vázsonyi ÉB., Koós M., Jalsovzsky, G. & Pócsik, I. (1993) The role of hydrogen in luminescence of electrochemically oxidized porous Si layer. *J. Lumin.*, Vol. 57, pp. 121-124.
- Volkenshtein, F.F., *Electronic Theory of Catalysis on Semiconductors*, Moscow: Fizmatgiz, 1960.
- Wang, M. & Feng, Y. (2007) Palladium-silver thin film for hydrogen sensing, *Sensors and Actuators, B*, Vol.123, pp. 101.
- Watanabe, Y. & Sakai, T. (1971) Application of a thick avoided film to semiconductor devices, *Rev. Electron. Commun. Labs.* Vol.19, pp. 899.
- Williams, GM. (1997) Cathodoluminescence properties of porous silicon. In: *Properties of porous silicon*. Canham L (ed), pp. 270-275, INSPEC, London.
- Wolford, DJ., Scott, BA., Reimer, JA. & Bradley, JA. (1983) Efficient visible luminescence from hydrogenated porous silicon, *Physica B*, Vol 117, pp 920-922
- Xu, C., Tamaki, J., Miura N. & Yamazoe, N. (1991) Grain size effects on gas sensitivity of porous SnO₂-based elements, *Sensors and Actuators, B*, Vol.3, pp. 147.
- Xu, Y.Y., Li, X.J., He, J.T., Hu, X. & Wang, H.Y. (2005) Capacitive humidity sensing properties of hydrothermally-etched silicon nano-porous pillar array *Sens. Actuators B* Vol.105, pp. 219.
- Yamazoe, N. (1991) New approaches for improving semiconductor gas sensors, *Sens. Actuators B*, Vol.5, pp. 7-19.
- Zhang, W., Vasconcelos, E.A., Uchida, H., Katsube, T., Nakatsubo, T. & Nishioka, Y. (2000) A study of silicon Schottky diode structures for NO_x gas detection, *Sens. Actuator, B*, Vol.65, pp. 154.
- Zhang, XG. (1991) *J Electrochem Soc*, Vol.140, pp. 2258.
- Zhua, B.L., Xie, C.S., Zeng, D.W., Song, W.L. & Wang, A.H. (2005) Investigation of gas sensitivity of Sb-doped ZnO nanoparticles, *Materials Chemistry and Physics* Vol.89, pp. 148.
- Zimin, S.P., Kuznetsov, V.S. & Prokaznikov, A.V. (1995)Electrical characteristics of aluminium contacts to porous silicon. *Appl Surf Sci.* Vol. 91, pp. 355.
- Zubko, V.G., Smith, T.L. & Witt, A.N. (1999) Silicon Nanoparticles and Interstellar Extinction, *The Astrophysical Journal Letters*, Vol. 511, pp. L57.

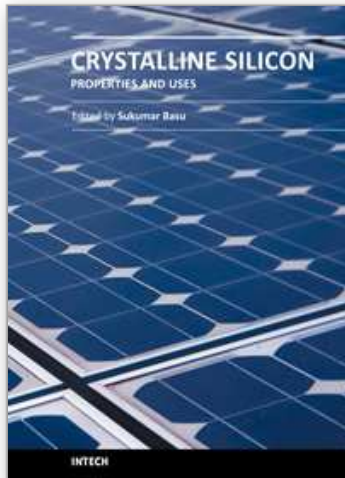

Crystalline Silicon - Properties and Uses

Edited by Prof. Sukumar Basu

ISBN 978-953-307-587-7

Hard cover, 344 pages

Publisher InTech

Published online 27, July, 2011

Published in print edition July, 2011

The exciting world of crystalline silicon is the source of the spectacular advancement of discrete electronic devices and solar cells. The exploitation of ever changing properties of crystalline silicon with dimensional transformation may indicate more innovative silicon based technologies in near future. For example, the discovery of nanocrystalline silicon has largely overcome the obstacles of using silicon as optoelectronic material. The further research and development is necessary to find out the treasures hidden within this material. The book presents different forms of silicon material, their preparation and properties. The modern techniques to study the surface and interface defect states, dislocations, and so on, in different crystalline forms have been highlighted in this book. This book presents basic and applied aspects of different crystalline forms of silicon in wide range of information from materials to devices.

How to reference

In order to correctly reference this scholarly work, feel free to copy and paste the following:

Sukumar Basu and Jayita Kanungo (2011). Nanocrystalline Porous Silicon, Crystalline Silicon - Properties and Uses, Prof. Sukumar Basu (Ed.), ISBN: 978-953-307-587-7, InTech, Available from:

<http://www.intechopen.com/books/crystalline-silicon-properties-and-uses/nanocrystalline-porous-silicon>

INTECH
open science | open minds

InTech Europe

University Campus STeP Ri
Slavka Krautzeka 83/A
51000 Rijeka, Croatia
Phone: +385 (51) 770 447
Fax: +385 (51) 686 166
www.intechopen.com

InTech China

Unit 405, Office Block, Hotel Equatorial Shanghai
No.65, Yan An Road (West), Shanghai, 200040, China
中国上海市延安西路65号上海国际贵都大饭店办公楼405单元
Phone: +86-21-62489820
Fax: +86-21-62489821

© 2011 The Author(s). Licensee IntechOpen. This chapter is distributed under the terms of the [Creative Commons Attribution-NonCommercial-ShareAlike-3.0 License](#), which permits use, distribution and reproduction for non-commercial purposes, provided the original is properly cited and derivative works building on this content are distributed under the same license.

IntechOpen

IntechOpen