

We are IntechOpen, the world's leading publisher of Open Access books Built by scientists, for scientists

4,800

Open access books available

122,000

International authors and editors

135M

Downloads

Our authors are among the

154

Countries delivered to

TOP 1%

most cited scientists

12.2%

Contributors from top 500 universities



WEB OF SCIENCE™

Selection of our books indexed in the Book Citation Index
in Web of Science™ Core Collection (BKCI)

Interested in publishing with us?
Contact book.department@intechopen.com

Numbers displayed above are based on latest data collected.

For more information visit www.intechopen.com



Conversion of Non-Homogeneous Biomass to Ultraclean Syngas and Catalytic Conversion to Ethanol

Stéphane C. Marie-Rose, Alexis Lemieux Perinet and Jean-Michel Lavoie
*Industrial Research Chair on Cellulosic Ethanol
Department of Chemical and Biotechnological Engineering
Université de Sherbrooke, Sherbrooke, Québec
Canada*

1. Introduction

Reducing greenhouse gas emissions, rising energy prices and security of supply are reasons that justify the development of biofuels. However, food prices recorded in 2007 and 2008 affected more than 100 million of people that became undernourished worldwide (Rastoin, 2008) The food crisis has been caused by several factors: underinvestment in agriculture, heavy speculation on agricultural commodities and competition of biofuels vs. food. It is estimated that by 2050, it will be essential to increase by 50% the food production to support the 9 billion people living on the planet (Rastoin, 2008).

Recycling the carbon from residual waste to produce biofuels is one of the challenges of this new century. Several companies have been developing technologies that are able to transform residual streams into syngas, which is subsequently converted into alcohols. "Green" ethanol plays an important role in reducing dependency toward petroleum and providing environmental benefit, through its role in the fuel additive market. Ethanol is an oxygenate and also serves as an octane enhancer. The waste-to-syngas approach is an alternative to avoid the controversy food vs. fuel whilst reducing landfills and increasing carbon recuperation. Using this approach, yields of ethanol produced are above 350 liters/dry tonne of feedstock entering the gasifier (Enerkem's technology is taken as example). Residual heat, also a product of the process, is used in the process itself and, as well, it can be used for outside heating or cooling. Enerkem Inc. is moving the technology from bench scale, to pilot, to demo to commercial implementation (a 12,500 kg/h of sorted and biotreated urban waste, is being constructed in Edmonton, Alberta). Economics of the process are favorable at the above commercial capacity, given the modular construction of the plant, reasonable operational costs and a tipping fee for the residue going into the gasifier.

The first part of this chapter will present feedstock preparation, gasification and gas conditioning. The characteristics of the heterogeneous feedstock will determine its performance during gasification for syngas production whose composition has the appropriate H_2/CO ratio for downstream synthesis. The second part of the chapter will be directed at the methanol synthesis in a three-phase reactor using syngas. The third and last part of the chapter will focus on the catalytic steps to convert methanol into bio-ethanol.

2. Synthesis gas (syngas) production by gasification

2.1 Characteristics and composition of heterogeneous wastes as feedstock

Biomass is defined as an organic material derived from plants or animals that contain potential chemical energy; for example wood, which was the first fire source used by mankind, and which is still used today by population for cooking and heating.

At world scale, biomass is now the fourth largest energy source, but it has the capacity to become the first. Photosynthesis can store up to 5-8 times more energy in biomass annually than the actual world energy consumption (Prins et al., 2005). The basic reaction of photosynthesis is as follow: carbon dioxide and water are converted to glucose and oxygen, an endothermic process for which the energy is supplied by photons. Examples of biomass are residues from agriculture or from the forest industry such as branches, straw, stalks, saw dust, etc. An important example of residual agricultural biomass is related to the ethanol production from sugar cane in Brazil which produces 280 kg of residual bagasse at 50% of dry solids. Lignocellulosic materials can be collected and recovered because this material has some energetic content (Ballerini and Alazard-Toux, 2006), however, leaving a part of this material on place is imperative since it keeps the soil fertile.

It is important for governments and citizens to realize that hydrocarbon-based waste material is another source of energy that should be taken advantage on. Waste can be solid or liquid form. It can be land filled, incinerated or converted. Municipal solid waste used electrical transmission poles and railroad ties treated with creosote, sludge from wastewater treatment and pulp and paper industries, wood from construction and demolition operations which contains paints and resins, etc., are all materials that contain carbon that can be valorized in bio-refineries such as the one Enerkem is constructing (2011) in Edmonton, AB.

Assessment of residual biomass or Municipal Solid Waste (MSW) as feedstock to produce bio-ethanol requires a basic understanding of feedstock composition and of the specific properties that dictates its performance as feed in the gasifier. The most important are: moisture content, ash content, volatile matter content, elemental composition and heating value.

The moisture content of biomass is the quantity of water in the material, expressed as percentage of material weight. This weight can be referred to on a wet basis or on a dry basis. If the moisture content is determined on a "wet" basis, the water's weight is expressed as a percentage of the sum of the weight of the water, ash, and dry- ash free matter. It is sometimes necessary to dry the feedstock to a certain level in order to maximize the gasification reaction. Indeed, more moisture is transferred by a higher consumption of oxygen in order to keep the ideal temperature in the gasifier. Temperature of gasification is crucial on the process efficiency. An optimum exists with just the right amount of oxygen needed to perform completely the gasification reaction. This represents a temperature of about 660°C for biomass with 20 % of moisture and about 695°C for biomass with 10 % of moisture (Prins et al., 2005). If more oxygen is added, formation of carbon dioxide will increase and gasification efficiency will drop; the heating value of the synthesis gas will thus decrease (van der Drift et al., 2001). However, not enough oxygen will promote reduction of carbon leading to an increase of methane formation.

The inorganic component (ash content) can be expressed the same way as the moisture content. In general, the ash content is expressed on a dry basis. Both total ash content and chemical composition are both important in regards of the gasification process. The

composition of the ash affects its behaviour under high temperatures of combustion and gasification. For example, melted ash may cause problems in both combustion and gasification reactors. These problems may vary from clogged ash-removal caused by slagging ash to severe operating issue in fluidized bed systems. Measurement of ash melting point is thus crucial.

Volatile matter refers to the part of biomass that is released when the biomass is heated beyond its dehydration temperatures. During this heating process the biomass decomposes into volatile gases and solid char. Biomass typically has a high volatile matter content (up to 80%), whereas coal has a low volatile matter content (<20%).

Elemental composition of the ash-free organic component of residual biomass is relatively uniform. The major components are carbon oxygen and hydrogen. Most biomass also contains a small proportion of nitrogen and sulfur. Table 1 presents the elementary composition of biomass as derived from ultimate analyses.

Element	Wt% (dry basis)
Carbon	44 - 51
Hydrogen	5.5 - 6.7
Oxygen	41 - 50
Nitrogen	0.12 - 0.6
Sulfur	0 - 0.2

Table 1. Elementary composition of residual biomass

The heating value of a fuel is an indication of the energy chemically bound in the fuel with reference to a standardized environment. The standardization involves the temperature, state of water, and the combustion products. The calorific value is presented as the higher heating value and the lower heating value. The higher heating value represents the heat release per unit of mass when the material (at 25°C) is completely oxidized to carbon dioxide and water and then returned to 25°C. A calorimetric bomb is the standard instrument used to measure this value. The lower heating value is not taking into account the energy supplied by the condensation of water (latent heat of vaporization of water at 25°C which is 2440 kJ/kg). The water includes moisture from the feedstock and the product from the reaction between oxygen and hydrogen comprised in the raw material (Borman and Ragland, 1998). Basic and complementary information about biomass intended for gasification can be obtained via the proximate and ultimate analyses.

Proximate analysis measures moisture content, volatile matter, fixed carbon, ash content and calorific value.

Ultimate analysis provides information about elementary composition of the biomass in weight percentage of carbon, hydrogen, oxygen, sulphur and nitrogen. The carbon to hydrogen ratio in the feedstock has a direct impact on the syngas, more particularly on the ratio of H₂/CO (Higman and van der Burgt, 2008).

Table 2 (depicted below) presents a comparison of different feedstock properties. Moisture content was provided after drying of feedstock and compositions are approximated (Ciferno and Marono, 2002).

Analysis		Sawdust	Bagasse	Switchgrass	Straw	Bituminous Coal	Dry Sewage (MSW)
Ultimate Analysis (% w/w) dry basis	C	50	48	43	43,5	61.5	20.5
	H	6,3	6.0	5.6	4.2	4.2	3.2
	O	43	42	46	40.3	6	17.5
	N	0,8	-	0.5	0.6	1.2	2.3
	S	0,03	-	0.1	0.2	5.1	0.6
Proximate Analysis (% w/w) dry basis	Moisture	7.8	1	8.4	7.6	8.7	4.7
	Volatiles	74	80	73	68.8	36.1	41.6
	Fixed Carbon	25.5	15	13.5	13.5	42	2.3
	Ash	0.03	4	4.5	10.1	21.9	56
	HHV (MJ/kg)	19.3	17	15.4	17	27	8

Table 2. Properties of biomass feedstocks

Note that higher calorific value formulas, referring to equation 1, were developed from the composition of the feedstock. Dulong formula is one of them (Higman and van der Burgt, 2008). However, numerous correlations were developed and reported in literature. For instance, experiments on more than 200 species were performed at the Indian Institute of Technology (Bombay) and the following equation was derived from empirical data.

$$\text{HHV (MJ/kg)} = 0.3491C + 1.1783H - 0.1034 O - 0.0211 A + 0.1005S - 0.0151N \quad (1)$$

Where C is the weight fraction of carbon, H of hydrogen, O of oxygen, A of ash, S of sulfur and N of nitrogen. This correlation offers an average absolute error of 1.45 % (Channiwala and Parikh, 2002).

There are other feedstock properties that are critical to determine in order to treat the material accordingly: size, distribution and shapes of the material, porous structure and bulk density. Gasification and incineration are both design for transforming hydrocarbon-based hazardous material to more simple by-products. Nonetheless, these two technologies are completely different in their operation and finalities. The goal of the combustion is to proceed to a complete oxidation of carbon in order to produce carbon dioxide and water. Thereby an excess of oxidizing agent is used. Sulfur and nitrogen comprised in the feedstock are oxidized to SO_x and NO_x . Whilst only gasification can lead to synthesis, both processes can lead to production of electricity. However, with the goal of generating added-value product, gasification has the possibility to convert the carbon of waste to biofuels instead of releasing the carbon as CO_2 . Gasification is a partial oxidation process with just enough oxygen to produce the heat to yield reduced carbon and hydrogen (Wetherold et al., 2000).

2.2 Syngas production and purification

Gasification produces a synthetic gas or syngas mainly composed of hydrogen, methane and carbon monoxide (Marie-Rose et al., 2011, Villano et al., 2010). Gasification started in the late 1800's and first applications were for town gas for street lights illumination and cooking purposes. Other applications were heating, production of raw material for chemical industry and also power generation. When the Second World War was raging and oil was limited, wood gasification was used for transportation and heat and power generation. The energy crisis of the 70's (1973 and 1979 oil shocks) also provided motivation for improving gasification technologies (Higman and van der Burgt, 2008).

The basics behind gasification are to react the feedstock containing carbon with steam and oxygen (could be air, enriched air or pure oxygen). The following chemical reactions are predominant during gasification (Higman and van der Burgt, 2008)

Thermal decomposition (i.e. pyrolysis), which covers dehydration as well as cracking reactions leading to gases, intermediate vapours and carbon structures known as "char". Partial oxidation of the "char" which forms CO and CO₂ generating heat for the otherwise endothermic reactions.

The partial oxidation

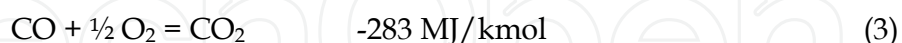
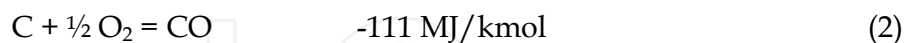

Steam-carbon, i.e. the water-gas reaction, that converts carbon structures into H₂ and CO.

The water gas reaction

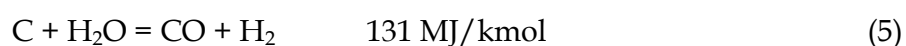

Steam reforming of intermediates formed by thermal decomposition.

The Steam methane reforming reaction

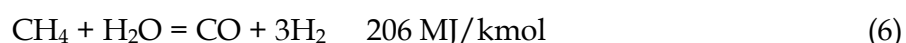

The steam reforming reaction

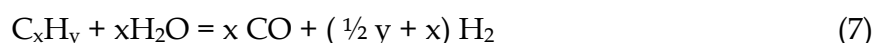

The dry reforming reaction

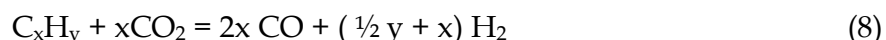

Reactions involving CO₂ and H₂ with carbon and with intermediates are kinetically slower than the steam induced reactions at the conditions used in gasifiers.

The Boudouard reaction

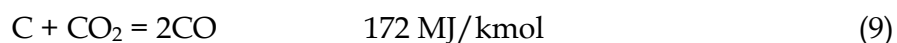

The methanation reaction

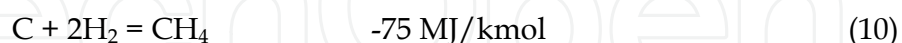

Water gas shift reactions that lead to a desired H₂/CO ratio.

The Water gas shift reaction

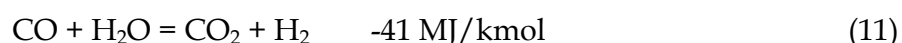

Steam is hence chemically involved in the gasification, but it also served as moderating agent to limit the temperature. Carbon dioxide could also be used to this purpose. Other elements in feedstocks such as sulphur, nitrogen and chlorine will lead to different molecular species contaminating the syngas such as H₂S, COS, NH₃, HCN and HCl.

Different types and configurations of reactors can be used to produce syngas: fixed bed, entrained flow gasifier and bubbling fluidized bed. Fixed bed gasifier (essentially slowly moving-beds) can be updraft or downdraft.

The **Updraft fixed bed gasifier** is probably the oldest technology. Biomass or coal are fed from the top and move slowly by gravity. A grate supports the material while oxidizing the gas in its way upwards. The synthesis gas is withdrawn at the top of the reactor and ash from the bottom. There is a combustion zone in the bottom where char combusts in contact of oxygen to form CO_2 . Char reacts with carbon dioxide to form two moles of carbon monoxide (equation 9). A zone of pyrolysis take place a little higher in the fixed bed because all oxygen has been consumed at this level. Finally, hot synthesis gas dries the feedstock at its entrance (Ciferno and Marono, 2002, Paes, 2005). This simple proven process has as drawback the production of a tar-rich syngas. Downdraft fixed bed gasifier employs co-current flow of oxidant and feedstock. This configuration has low tar formation as an outcome. Nevertheless, a part of the carbon remains unconverted (Ciferno and Marono, 2002).

Entrained flow gasifier utilizes a blast of oxidant in a co-current arrangement with the feed grounded to ensure carry-over. A high temperature is necessary because of the short residency time, counted in seconds. More oxygen is thus required to reach higher temperature (Higman and van der Burgt, 2008). With this type of gasifier, the particles entrained are passed to a cyclone and a riser to bring this material again through the bottom of the gasifier.

Bubbling fluidized bed gasifier is designed to keep the particles in suspension. This technology is based on a configuration where feedstock is added continuously to a bed of alumina, olivine (iron and magnesium orthosilicate) and/or other material serving as a heat carrier. This type of gasifier has high heat/mass transfer and conversion and is able to treat a large range of particles sizes and heterogeneous feedstock. Fluidized bed gasifier has the following advantages: flexibility and easiness for control and maintenance. Figure 1 illustrates an overview of the process developed by Enerkem Inc based on a bubbling fluidized reactor.

Feeding is assured by conveyor, lock hoppers, rotary valves and cooled feeding screw. Oxygen and steam are added through the bed in order to fluidize the medium. Low severity conditions are used in the bed, i.e. pressure lower than 4 atm and temperature lower than 750°C (Chornet et al., 2010). The reactor itself is made from carbon steel with insulation and refractory.

Ash is collected at the cyclones and larger inert material exits at the bottom of the gasifier. Ash can be composed of silica, alumina, potassium, phosphorus, sodium, magnesium, ferric oxide, and smaller amounts of titanium oxide and sulfur compounds (Higman and van der Burgt, 2008).

CaO/MgO is also introduced in the gasifier for neutralising a part of HCl , H_2S and COS formed. Literature reports that the use of calcined dolomite and NiO-loaded calcined dolomite helps in the reduction of tar and char formation (Corujo et al., 2010). This dolomite contained 24,6 % of Ca, 19,7 % of Mg and 0,035 % of Fe on a weight basis. Calcination of dolomite produces magnesium and calcium oxides. Corujo et al. have stated that the use of NiO-loaded calcined dolomite catalysts increased the total product gas volume by 30% and decreased the rate of char and tar formation leading to a higher gas energy yield. In fact, bed materials are selected for two criteria: attrition resistance and possible catalytic activity in hydrocarbon and tar reforming. Olivine was compared to silica sand, dolomite, ash, magnetite and iron ore. With the use of Olivine, higher conversion of toluene was observed during steam gasification at 900°C (Rauch et al., 2004).

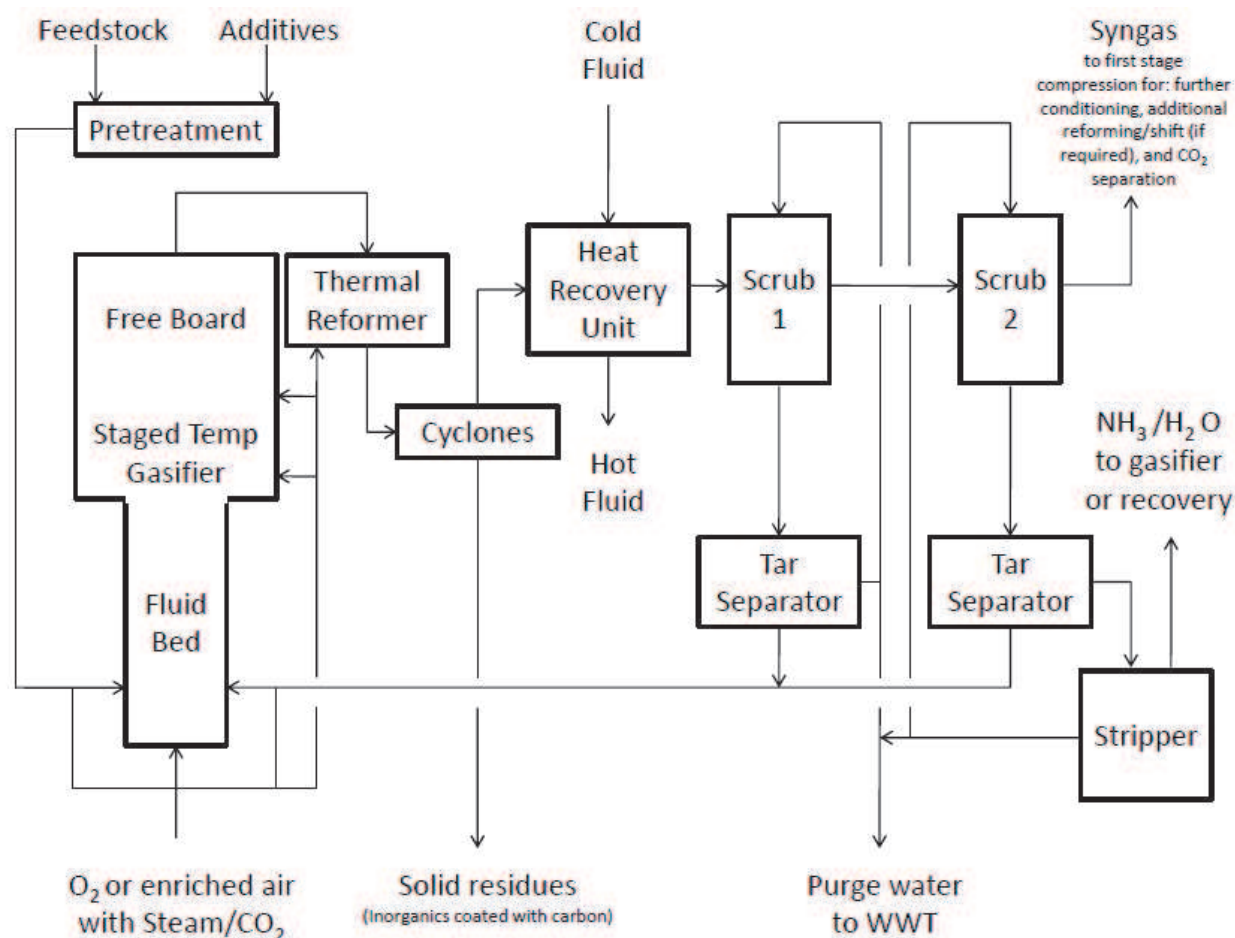

Fig. 1. Schematic diagram of Enerkem's process

Comparison of Ni/olivine catalyst with olivine alone demonstrated a higher activity, a higher selectivity to hydrogen and carbon monoxide and a lower carbon deposition. These observations were explained by an enhanced steam adsorption on magnesium oxide facilitating surface carbon gasification rates and by nickel dilution effect, associated with Fe-Ni alloys, ensuring stable catalyst activity (Swierczynski et al., 2007)

Leaving the freeboard of the gasifier, the syngas is composed of: H₂, CO, CO₂, H₂O N₂, hydrocarbons, tar, fines, char and contaminants. Tar is a complex blend of condensable hydrocarbons, which includes single to five-rings aromatic compounds along with oxygen-containing hydrocarbons and complex PAH (Yan et al., 2006). The freeboard is sized appropriately for disengagement of alumina and/or other solid fluidized bed materials.

A reforming zone is used for converting hydrocarbons, tar and char to obtain more syngas (see equations 8, 9, 10 and 11). Since thermal decomposition of hydrocarbons requires activation and that reforming reactions are endothermic, heating the gas, by direct or indirect manner, is essential. For example, if oxygen is injected directly, it must be added carefully to avoid lowering the product gas heating value and cold gas efficiency. However, with just the right amount of the oxidizing gas, selective oxidation of methane, ethylene and propylene will occur (Villano et al., 2010). Target temperatures are in the 750°C to 1200°C range. Table 3 depicts general compositions of syngas produced out of some previously mentioned biomass.

Biomass	MSW	MSW	Sludges*	Res. Forest/Agriculture	Typical biomass
Conditions	700 °C, Fixed bed gasifier, Dolomite (Catalyst),	900 °C, Fixed bed gasifier, Dolomite (Catalyst), Steam (oxidizing agent)	829 °C Fluidized bed	900 °C, Fixed bed gasifier, Dolomite (Catalyst), Steam (oxidizing agent)	O ₂ / Steam / CO ₂ low severity gasification + Thermal cracking and reforming at higher severity
Char (%w/w)	19.15	12.65	n.d	n.d	n.d
Tar (%w/w)	12.94	2.62	n.d	n.d	n.d
Gas (%w/w)	94.52	145.23	n.d.	n.d.	n.d.
Gas composition	% mol	% mol	% mol	% mol	% mol
H ₂	16.92	36.98	17.23	46.2	23-27
CO	20.33	27.37	26.17	33.2	21-23
CO ₂	35.28	20.78	45.64	16.1	38-44
CH ₄	21.44	9.94	7.96	4.4	6-8
C ₂	6.03	4.93	3.00	0.1	-
C ₂ H ₄	n.d	n.d	n.d	n.d	Traces
C ₂ -C ₅	n.d	n.d	n.d	n.d	0.2-0.5
C ₅ -C ₁₀	n.d.	n.d.	n.d.	n.d.	Traces
Reference	(He et al., 2009)	(He et al., 2009)	(Van der Drift et al., 2001)	(Corujo et al., 2010)	(Marie-Rose et al. 2010)

* Demolition wood + paper residue sludge
n.d. not determined

Table 3. Solid, liquid and gas ratio as well as gas composition following gasification of common residual feedstocks.

Increasing temperature cause the decomposition of char and tar by thermal cracking and steam reforming reactions. Moreover, this has a direct impact on the production and composition of the gas as seen from table 3 (He et al., 2009)

Cyclones are used for entrained ash removal. The latter having typically a diameter greater than 10 microns. Efficiency of this cyclone system is from 90 to 95% and mostly recuperates char. Following the cyclone and recuperation of ash, the next unit operation is a heat exchanger. The latter cools the crude synthesis gas and allocates heat recovery for other application on the process using thermal oil or liquid water which turns to steam.

Note that the reforming step mentioned above could be by-passed directly to the cyclones if the feedstock contains inorganic materials that form eutectics with low melting point. Indeed, high temperature in this situation would have as a consequence scaling and fouling of the walls of the system.

Quenching is required for further cooling and removal of condensable materials, tars and fines. In the following step, a wet venturi scrubber with alkaline water is used for neutralisation of acid gases as H₂S and HCl. A coalescer/demister at the exit removes fines particles and mist.

A second scrubbing step involving neutral or slightly acidic water is used in order to capture ammonia, trace tars, residual fines and impurities such as chlorine and metals. After this cooling step, the cooled purified syngas is around 30 °C.

Water is recirculating after proper handling. The water loop includes knockout drums and separation of tars and fines particles with air flotation, decanters and/or centrifuges. The skimmed phase recovered (overflow), enclosing tars and fines particles, is emulsified and recycled to the gasifier. The underflow, containing heavier organics and particles, is also re-injected to the gasifier. A part of the recirculated water is withdrawn from the system to maintain the balance of water and contaminants. This purge is subjected to water treatment in the objective of meeting below the required environmental standards. Note that ammonia is separated from the water by steam stripping above 100°C and at about 1 to 3 atm. The ammonia is sent back to the gasifier producing hydrogen and nitrogen.

An additional reforming step is then possible for converting light hydrocarbons to more CO and H₂ and final adjustment of the molar ratio of H₂/CO.

The syngas is then passed through filters and adsorbers for dehumidification, elimination of traces of chlorine, sulphur and other contaminants such as metal carbonyls. An ultraclean syngas is obtained and compression follows to remove carbon dioxide assisted either by amine-based processes or chilled methanol.

3. Syngas conversion into methanol

3.1 Thermodynamic consideration

The two major components of synthesis gas, hydrogen and carbon monoxide are the building blocks of what is often known as C1 chemistry. Conversion of *syngas* to liquid fuels as well as conversion rates is directly related to the composition of the catalyst. Syngas can be efficiently converted to different products as alcohols and aldehyde (Figure 2).

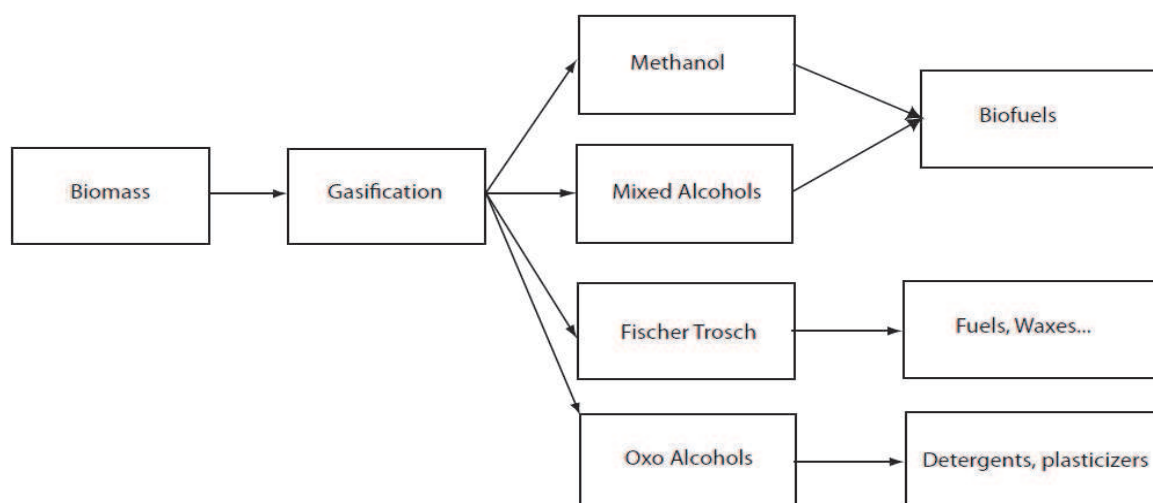
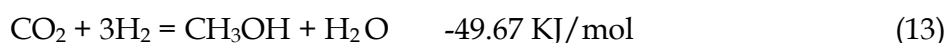
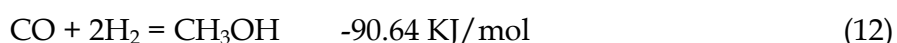

Fig. 2. Examples of application for syngas produced from biomass (Higman and van der Burgt, 2008)

Although many routes are available, the most promising route at industrial level is the production of methanol since the synthesis yields are the highest. The conversion to synthetic liquids as methanol is strongly influenced by thermodynamic factors (Rostrup-Nielsen, 2000).



For methanol synthesis, a stoichiometric ratio defined as (H₂-CO₂)/(CO+CO₂), of about 2 is preferred, which implies that there should be just the stoichiometric amount of hydrogen needed for methanol synthesis. For kinetic reasons and in order to control by-products formation, a value slightly above 2 is normally preferred (Dybkjr and Christensen, 2001).

Moreover, methanol synthesis is subjected to a thermodynamic equilibrium that limits the process to low conversion per pass and therefore implies a large recycle of unconverted gas. The reaction is strongly exothermic and consequently requires significant cooling duty.

Different phenomena exist at high and low pressure conditions. As example, when the pressure is relatively low, increasing temperature, CO conversion is not monotonic, and the trend is that of an increase followed by a decrease with the maximum conversion appearing near 250°C. This phenomenon is in agreement with many works in the literature (Li and Inui, 1996, Liaw and Chen, 2001, Wang et al., 2002). As the reaction temperature increases, the reaction rate gets higher and leads to the increase of CO conversion. However, methanol synthesis is an exothermic reaction and low temperature is more beneficial considering equilibrium. The conversion does not continue to increase due to the thermodynamic limitation and a decrease trend will even appear. When the system pressure is relative high, because of the relatively low CO conversion, the system is far from the thermodynamic equilibrium and under the control of reaction kinetics. In this case, CO conversion increases monotonically with an increase in temperature. From a mechanistic point of view for the methanol synthesis, two main reactions need to be in line with real world situation: CO hydrogenation and CO₂ hydrogenation.

3.1.1 CO hydrogenation as principal reaction for methanol synthesis

In this case, the main reaction leading to methanol is the hydrogenation of CO.

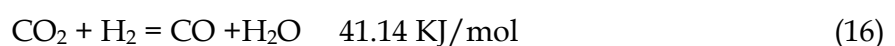

According to equation (15) methanol is predominantly synthesised via the direct hydrogenation of CO. The second reaction is the reverse of Water Gas Shift (RWGS). Experimental data involving typical syngas mixtures that contain 3 to 9% CO₂ show a decrease of its concentration in the reactor effluent stream (Sunggyu, 2007). It should be noted that the first reaction (methanol synthesis) is exothermic, whereas the second (RWGS) is endothermic. According to this depletion of carbon dioxide in the RWGS reaction, produce more reactant (CO) which overall boost the synthesis of methanol. Until 90s the role of CO₂ in the methanol synthesis was not clear. Deficiency of CO₂ in the feed composition can be extremely detrimental to the overall synthesis, very rapidly deactivating the catalysts and immediately lowering methanol productivity in the process. Typically, 2 to 4% of CO₂ is present in the syngas mixture for the vapor-phase synthesis of methanol, whereas this value is somewhat higher, with 4 to 9%, for liquid-phase synthesis (Cybulski, 1994).

3.1.2 CO₂ hydrogenation as principal reaction for methanol synthesis

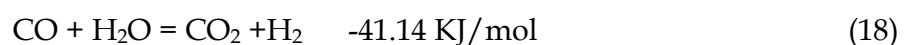
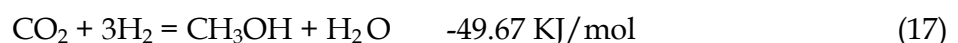

In this case, the main reaction leading to methanol is hydrogenation of CO₂.

It should be noted that according to this reaction, the synthesis of methanol proceeds predominantly by direct hydrogenation of CO₂ and not CO. It should also be noted that the

WGS reaction proceeds in the forward direction, consuming CO to produce the main reactants: CO₂ and H₂, thus boosting the eventual methanol productivity. A number of authors (Cybulski, 1994, Lee et al., 1989) have tried a variety of reaction to elucidate the true reaction pathways or mechanistic pathways, including isotope labelling studies and kinetic studies involving complete absence of one of the syngas components.

3.2 Catalysts used

The first high-temperature, high-pressure ever used methanol synthesis catalysts were ZnO/Cr₂O₃ and were operated at 350°C and 250-350 bar. Catalyst compositions contained 20-75 atom% Zn and these catalysts demonstrated high activity and selectivity for methanol synthesis and proved robust enough resist sulphur poisoning which is inherent when converting syngas from coal gasification. Over the years, as gas purification technologies improved, interest in the easily poisoned Cu catalysts for methanol synthesis was renewed. In 1966, ICI introduced a new, more active Cu/ZnO/Al₂O₃ catalyst was the first of a new generation of methanol production using lower temperature (220-275°C) and lower pressure (50-100 bar) than the established ZnO/ Cr₂O₃ catalysts. The last high temperature methanol synthesis plant was closed in the mid-1980s (Fiedler et al., 2003) and at the present, low temperature, low pressure processes based on Cu catalyst are used for all commercial production of methanol from syngas. The synthesis process has been optimised to the point that the modern methanol plants yield 1 kg of methanol/liter of catalyst/hr with >99.5% selectivity for methanol. Commercial methanol synthesis catalyst has lifetimes on the order of 3-5 years under normal operating conditions.

The Cu crystallites in methanol synthesis catalysts have been identified as the active catalytic sites although the actual state (oxide, metallic...) of the active Cu site is still being debated. The most active catalysts all have high Cu content, optimum about 60 wt% Cu on the catalyst that is limited by the need to have enough refractory oxide to prevent sintering of the Cu crystallites. Hindering agglomeration is why ZnO creates a high Cu metal surface area. ZnO also interacts with Al₂O₃ to form a spinel that provides a robust catalyst support. Acidic materials like alumina, are known to catalyse methanol dehydration reactions to produce DME. By interacting with the Al₂O₃ support material, the ZnO effectively improves methanol selectivity by reducing the potential for DME formation. Catalysts are typically prepared by the co-precipitation of metal salts with a variety of precipitation agents. It is important to avoid contaminating methanol catalysts with metals that have FT (Fischer Tropsch) activity (Fe or Ni) during the synthesis. Incorporation of alkali metal in the catalyst formulation should also be avoided because they catalyse the increase of higher alcohols production. Table 4 shows catalyst formulation from several commercial manufacturers.

Additional catalyst formulations have been presented in the literature with the purpose of improving per-pass methanol yields (Klier, 1982). The addition of Cs to Cu/ZnO mixtures has shown improved methanol synthesis yields. This only holds true for the heavier alkali metals, as the addition of K to methanol synthesis catalysts tends to enhance higher alcohols yields. The Cu/ThO₂ intermetallic catalysts have also been investigated for methanol synthesis (Klier, 1982). These catalysts have demonstrated high activity for forming methanol from CO₂-free syngas. Cu/Zr catalysts have proven active for methanol synthesis in CO-free syngas at 5 atm and 160-300°C (Herman, 1991). Supported Pd catalysts have also demonstrated methanol synthesis activity in CO₂-free syngas at 5-110 atm and 260-350°C (Spath and Dayton, 2003).

Manufacturer	Cu (wt%)	Zn (wt%)	Al (wt%)	Other
IFP	45 - 70	15 - 35	4 - 20	Zr - 2-18
ICI	20 - 35	15 - 50	4 - 20	Mg
BASF	38.5	18.6	12.9	Rare Earth oxide - 5
Shell	71	24		
Sud Chemie	65	22	12	
Dupont	50	19	31	
Haldor Topsoe	>55	21 - 25	8 - 10	

Table 4. Commercial Methanol synthesis catalyst formulation (Spath and Dayton, 2003)

3.3 Methanol synthesis reactors

Today, the majority of the methanol is synthesised from syngas produced by steam reforming of natural gas (SMR). The synthesis can be done either with heat provided by a furnace where the tubular reactor is located, or by auto-thermal reforming (ATR) combined with steam reforming. Once the natural gas is reformed the resulting synthesis gas can be shift adjusted for its H₂/CO ratio and the CO₂ decreased to a few percentages as previously specified. The syngas is then fed to a reactor vessel in the presence of a catalyst to produce methanol and water vapor. This crude methanol, which usually contains up to 18% water, plus ethanol and higher alcohols is fed to a distillation plant that consists of a unit that removes the volatiles and a unit that removes the water and higher alcohols. The unreacted syngas is recirculated back to the methanol converter resulting in an overall conversion efficiency of 99%. A generic methanol synthesis process flow diagram (PFD) is shown in the Figure 3.

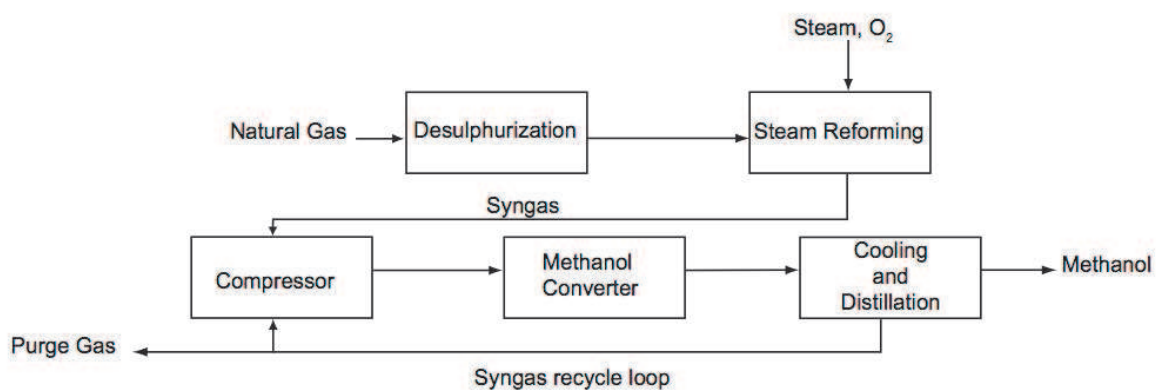

Fig. 3. Simplified Methanol Synthesis PFD (Spath and Dayton, 2003).

As is the case with Fisher Tropsch synthesis, one of the challenges associated with commercial methanol synthesis is removing the large excess heat of reaction. Methanol synthesis increases at higher temperatures so does the chance for competing side reactions. Controlling and dissipating the heat of reaction and overcoming the equilibrium constraint to maximise the per-pass conversion efficiency are the two main process features that are considered when designing the methanol synthesis reactor, commonly referred to as a methanol converter. Numerous methanol converter designs have been commercialised over the years and these can be roughly separated into two categories: adiabatic or isothermal reactors.

- Adiabatic reactors often imply multiple catalysts beds separated by gas cooling devices, either direct heat exchange or injection of cooled, fresh or recycled syngas.
- The isothermal reactors are designed to continuously remove the heat of the reaction so they operate essentially like a heat exchanger.

Haldor Topsoe low-pressure methanol synthesis process. This process is designed to produce methanol from natural gas or associated gas feedstocks, utilizing a two-stage reforming process to generate a syngas mixture feed for the methanol synthesis (Sunggyu, 2007). Associated gas is natural gas produced with crude oil from the same reservoir. It is claimed that the total investment for this process is lower than with the conventional flow scheme based on straight steam reforming of natural gas by approximately 10%, even after considering an oxygen plant. As shown in figure 4, the two stage reforming is conducted by primary reforming in which a preheated mixture of natural gas and steam is reacted, followed by a secondary reforming which further converts the exit gas from the primary reformer with the aid of oxygen that is feed separately. The amount of oxygen required as well as the balance of conversion between the primary and the secondary reformers need to be properly adjusted so that a balanced syngas (in a stoichiometric ratio (2:1) of H_2/CO) is obtained with a low inert content.

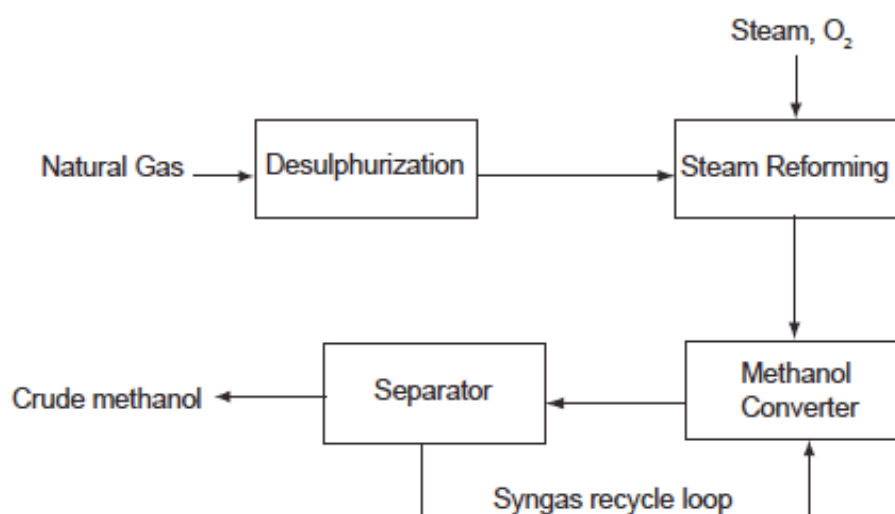

Fig. 4. Haldor Topsoe methanol synthesis process (Sunggyu, 2007).

Liquid-Phase methanol process. The liquid phase methanol process was originally developed by Chem. Systems Inc in 1975 (Cybulski, 1994). The R&D of this process was sponsored by the U.S. Department of Energy and Electric Power Research Institute. Commercialised by Air Products and Chemicals Inc and Eastman Chemical Co. in the 1990s, the process is based on the low-pressure methanol synthesis using coal as the source of syngas. Recently, in Québec (Canada) Enerkem Inc. has developed a liquid phase methanol process using syngas produced from biomass. The chemical reaction is carried out in a slurry reactor using a $Cu/ZnO/Al_2O_3$ catalyst at temperature ranging from 230 to 260 °C and 50 to 100 atm. The commercial reactor used a liquid entrained reactor in which fine grains of catalyst are slurried in an inert high-boiling oil typically white mineral oil. Pressurized gaseous reactants are dissolved in the oil and the dissolved molecular species are reacted on the catalytic surfaces of the grains present in a slurry. The figure 5 shows the schematic of liquid phase methanol process of Enerkem Inc.

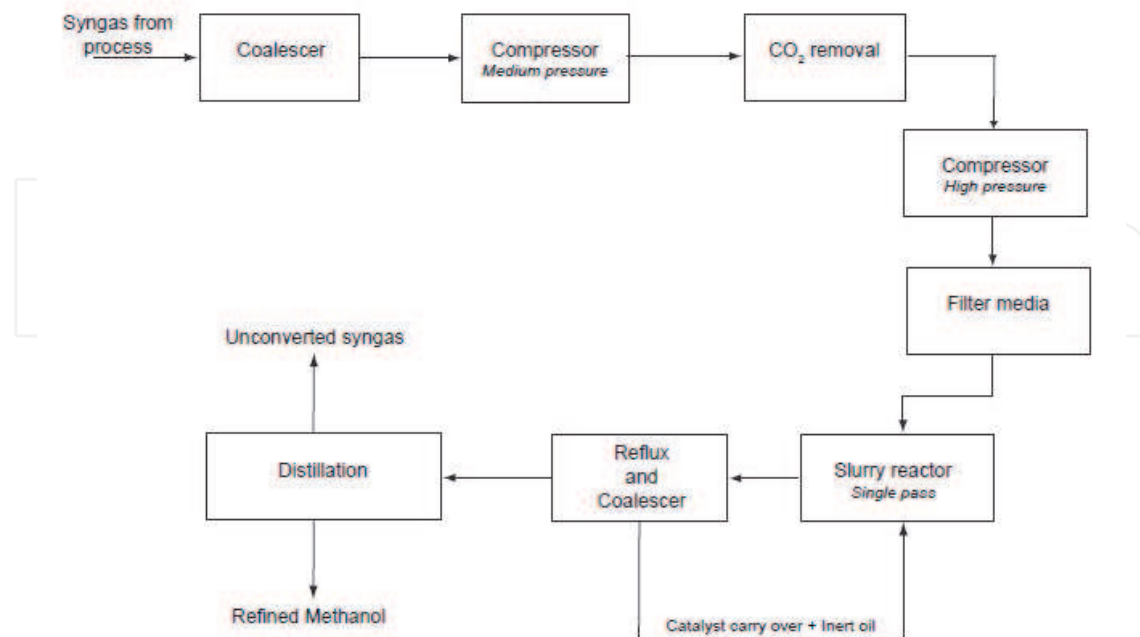

Fig. 5. Enkern Inc. liquid phase methanol process

4. Ethanol synthesis

Ethanol can be readily produced by fermentation of simple sugars that are hydrolyzed from starch crop. Feedstocks for such fermentation include corn, barley, potato, rice and wheat (Cybulski, 1994). Sugar ethanol can be called *grain ethanol*, whereas ethanol produced from cellulose biomass is called *cellulosic or second generation ethanol*. Both grain ethanol and cellulosic are produced via biochemical processes, whereas *chemical ethanol* is synthesised by chemical synthesis routes that do not involve fermentation. In fact, thermo-catalysis process route can be a good alternative to the bioprocess route. In a recently reported process (Chornet et al., 2009) the ethanol is produced by a two steps process: first methanol carbonylation to produce methyl acetate and second hydrogenolysis of the latter as illustrated in the figure 6.

4.1 Methanol carbonylation: methyl acetate synthesis

Methyl acetate is produced industrially by methanol carbonylation in the acetic acid production processes. Methanol carbonylation reaction is a well known reaction since Monsanto in 1970 performed it in liquid phase using a rhodium-base catalytic system. which was later acquired and optimized by Celanese. Such system had been preceded by a cobalt-based system developed by BASF, which suffered from significantly lower selectivity and the necessity for much harsher conditions of temperature and pressure. Although the rhodium catalysed system has much better activity and selectivity, the R&D has continued for new catalysts which improve efficiency even further. The strategies employed have involved either modifications to the rhodium-based system or insertion of another metal, eventually Iridium (Haynes, 2006). In the homogenous system, acetic acid was used as solvent, so esterification leads to substantial conversion into methyl acetate. Methyl acetate formation is facilitated by

the methyl iodide used in carbonylation as a mediator. Heterogenous systems for methanol carbonylation have been suggested for several years. Research has been primarily focus on two possible catalysts for this reaction: 1) rhodium supported polymers (Acetica process as an example) or 2) zeolites and a variety of metals supported on activated carbon (Merenov and Abraham, 1998). The choice of the support seems to play an important role in the activity of the catalyst (Yashima et al., 1979). Another way to produce methyl acetate is by an esterification reaction. Eastman Chemical Company, produced methyl acetate by the esterification of methanol with acetic acid in a reactive distillation column.

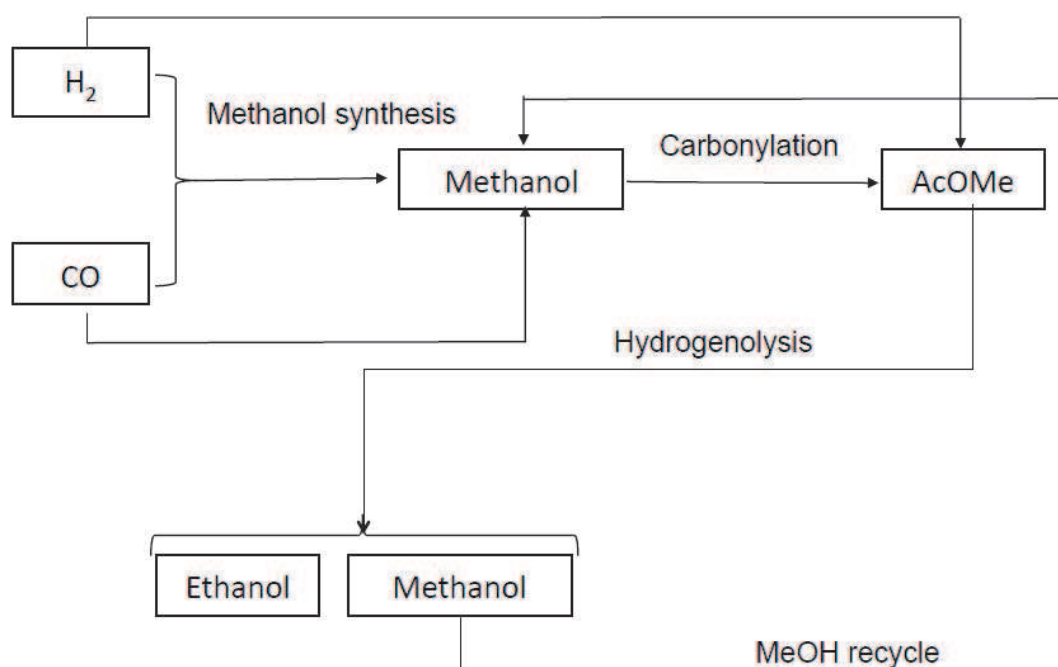

Fig. 6. Enerkem Inc. ethanol pathway production.

This company claimed the first commercial plant of reactive distillation (Zoeller, 2009). As illustrated by figure 7, in the reactive distillation there are three sections in the column, water/methanol stripping zone in the bottom, a reaction zone in the center, and methyl acetate enriching at the top. Descriptively, methanol (b.p. 65°C) is added at the bottom of the reaction zone and acetic acid (b.p. 118°C) and acid catalyst are added at the top of the reaction zone.

As methanol ascends up the column it encounters a consistently richer acetic acid concentration, which drives the equilibrium toward the products and prevents methanol from leaving column. Likewise, as acetic acid descends down the column, it also encounters a continuously enriched stream of methanol, which also pushes the equilibrium toward products and prevents acetic acid reaching the bottoms of the column. However, the acetic acid also serves as extractant for water, breaking the various azeotropes. A short section is left at the base of the distillation column to strip all the methanol and a short section is added at the top of the column to enrich methyl acetate and prevent acetic acid from being entrained as the product is distilled overhead in the column. By properly balancing the addition rates, the reaction provides methyl acetate in 100% yield based on both acetic acid and methanol.

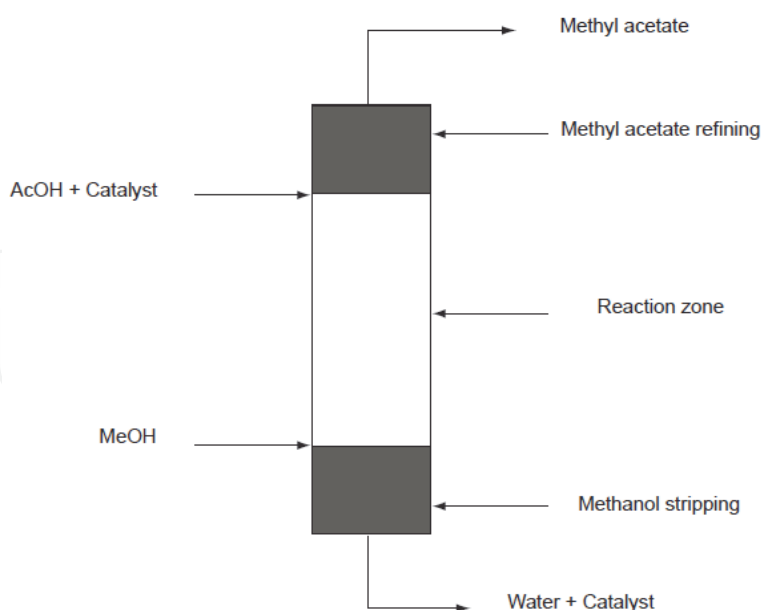
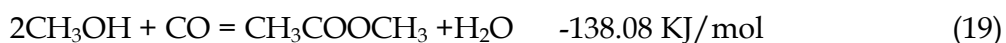

Fig. 7. Reactive distillation of methanol (MeOH) and acetic acid (AcOH) to form methyl acetate.

Enerkem Inc. has focused on the new gas phase approach to the carbonylation reaction. As acetic acid is not the desired end product of the carbonylation, the reaction conditions have been tailored to favour the methyl acetate directly according to the equation:



This is advantageous for Enerkem Inc. since it reduces by one step their process leading to ethanol. Forcing the reaction towards methyl acetate also facilitates a strategy based on gas phase reactor. In the process, the methanol carbonylation is carried out maintaining methanol in the vapor phase using a fixed bed packed a rhodium-based catalyst. The methanol is vaporized under pressure and mixed with the CO-rich gas prior to flowing through the reactor. The methanol to CO molar ratio is comprised between 1 and 4. Methyl iodide (co-catalyst and mediator) is added to the system at a suitable mol ratio relative to methanol. The operating conditions are such that the GHSV (based on CO) varies up to 2,000 h⁻¹. At temperature comprised between 170 to 300°C and total pressure from 10 to 50 atm, it is found that the CO is converted at rate near 100% when the methanol:CO ratio is up to 2 (Chornet et al., 2009).

4.2 Methyl acetate hydrogenation

Esters (i.e. methyl acetate) are ubiquitous in nature and have vast industrial and commercial applications based on different substituent groups. An important class of industrial catalytic process for esters reduction is metal-catalyzed hydrogenolysis for the production of alcohols (e.i. ethanol) (Adkins and Folkers, 1931, Adkins et al., 1933, Turek et al., 1994a, Xu and Xu, 2010) New applications for ester hydrogenolysis are being found in catalytic upgrading and conversion of renewable resources such as lignocellulosic biomass into fuels or fine chemicals (Corma et al., 2007, Huber et al., 2006). Copper-based catalysts are widely used for ester hydrogenolysis (Adkins and Folkers, 1931, Cybulski et al., 2001, Thomas et al., 1992,

Turek et al., 1994b, Turek et al., 1994a). They show very good activity and selectivity for alcohols under high temperature and hydrogen pressure (500-700K, 200-300 bar). Precious metal-based alloys (Rh-Sn for example) show promise of lessening the severity of the reaction conditions (lowering hydrogen pressure to below 100 bar), but precious metal are costly and tend to favor hydrocarbon production.

In our approach, the recovered methyl acetate is maintained in liquid phase at 20°C. It is pumped against pressure ranging from 10 to 50 atm, through a heat exchanger that vaporizes it completely at temperature ranging 150 to 425°C. Hydrogen, preheated at the same temperature range is mixed with the methyl acetate vapor at the exit of the heat exchanger. The molar ratio hydrogen to methyl acetate is from 4 to 11. The hot mixture is flown through a catalytic bed where the catalyst CuO/Cr₂O₃ or CuO/ZnO/Al₂O₃ catalyst is placed. The CuO is reduced with H₂/N₂ mixtures prior to adding any methyl acetate (Claus et al., 1991). Methyl acetate is converted to ethanol and methanol according to the equation:

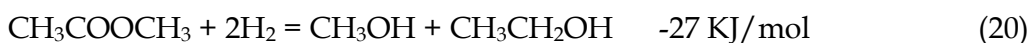

The GHSV (based on H₂) of the reaction is comprised between 1,000 and 2,000 h⁻¹ and the methyl acetate conversion reached 95%, with a slightly higher selectivity towards ethanol.

5. Conclusion

Biomass is a renewable energy source whose conversion to biofuels is an option to reduce oil dependency and reduce the carbon dioxide footprint characteristic of fossil fuels.

This chapter has shown the chemical steps needed to convert non-homogeneous biomass into bioethanol via gasification. The syngas produced is catalytically turned into biofuels (methanol and ethanol). Such approach is practiced by Enerkem's which uses non-homogeneous residual biomass including urban biomass as feedstock for the gasification. The syngas produced is cleaned prior used for catalytic synthesis of methanol. The reactor used for the methanol synthesis is a three phase reactor based on the Liquid-Phase methanol process. The yield of methanol is about 1 kg_{MeOH}/kg_{cat}/h and the selectivity of the reaction into methanol is about 99%. The refined methanol produced is carbonylated to produce methyl acetate. The synthesis of methyl acetate is carried in a fixed bed reactor and uses a halide component as co-catalyst. The methyl acetate is hydrogenolized to form stoichiometrically one mole of ethanol and one mole of methanol. The methanol produced at the end of the process is recycled into the carbonylation unit.

6. Acknowledgement

The authors would like to acknowledge financial support of the sponsors of the Industrial Chair in Cellulosic Ethanol: the Quebec's government (MRNF) and its industrial partners: Greenfield Ethanol, CRB innovations and Enerkem. Additional support from NSERC's Synergy program is also acknowledged.

7. References

- J.-L. Rastoin, (2008). Agrocarburant et sécurité alimentaire: l'alliance impossible, Vol. 1.
- M. J. Prins, K. J. Ptasinski and F. J. J. G. Janssen, (2005). Exergetic optimisation of a production process of Fischer-Tropsch fuels from biomass, Vol. 86, No. 4, pp. 375-389, 0378-3820

- D. Ballerini and N. Alazard-Toux. (2006). Les biocarburants: état des lieux, perspectives et enjeux du développement, Technip, 9782710808695,
- A. van der Drift, J. van Doorn and J. W. Vermeulen, (2001). Ten residual biomass fuels for circulating fluidized-bed gasification, Vol. 20, No. 1, pp. 45-56, 0961-9534
- G. L. Borman and K. W. Ragland. (1998). Combustion engineering, McGraw-Hill, 9780070065673,
- C. Higman and M. van der Burgt. (2008). Gasification (2nd Edition), Elsevier, 978-0-7506-8528-3,
- J. P. Ciferno and J.J. Marano (2002). Benchmarking Biomass Gasification Technologies for Fuels, Chemicals and Hydrogen Production, report for US DOE.
- S. A. Channiwala and P. P. Parikh, (2002). A unified correlation for estimating HHV of solid, liquid and gaseous fuels, Vol. 81, No. 8, pp. 1051-1063, 0016-2361
- B. Wetherold, D. Orr, D. Maxwell (2000). A comparison of gasification and incineration Hazardous wastes. US DOE, DCN 99.803931.02
- S. C. Marie-Rose, J.-M. Lavoie, D. Lynch and E. Chornet. (2011). From biomass-rich residues into fuels and green chemicals via gasification and catalytic synthesis, WIT Transaction on Ecology and the Environment, Vol. 143, pp. 123-132, 1743-3541
- S. M. Villano, J. Hoffman, H.-H. Carstensen, A.M. Dean (2010). Selective Oxidation of Ethylene in a Model "Dirty Synthesis Gas Stream: An Experimental and Kinetic Modeling Study, ACS National meeting, San Francisco
- T. Paes (2005). Modeling for control of biomass gasifier, Thesis of Eindhoven University of Technology.
- E. Chornet, B. Valsecchi, G. Drolet, M. Gagnon, B. Nguyen (2010). Production and conditioning of synthesis gas obtained from biomass. Patent Application number 20100051875.
- A. Corujo, L. Yermán, B. Arizaga, M. Brusoni and J. Castiglioni, (2010). Improved yield parameters in catalytic steam gasification of forestry residue; optimizing biomass feed rate and catalyst type, Vol. 34, No. 12, pp. 1695-1702, 0961-9534
- R. Rauch, H. Hofbauer, K. Bosch, I. Siefert, C. Aichernig, H. Tremmel, K. Voigtlaender, R. Koch, R. Lehner (2004). Steam Gasification of Biomass at CHP Plant in Guessing-Status of the Demonstration Plant. 2nd World Conference and Technology Exhibition on Bioamass for Energy, Italy.
- D. Swierczynski, S. Libs, C. Courson and A. Kiennemann, (2007). Steam reforming of tar from a biomass gasification process over Ni/olivine catalyst using toluene as a model compound, Vol. 74, No. 3-4, pp. 211-222, 0926-3373
- C. Yan, W. Yang, J. T. Riley and W.-P. Pan. (2006). A novel biomass air gasification process for producing tar-free higher heating value fuel gas, Elsevier, Amsterdam, PAYS-BAS
- M. He, B. Xiao, Z. Hu, S. Liu, X. Guo and S. Luo, (2009). Syngas production from catalytic gasification of waste polyethylene: Influence of temperature on gas yield and composition, Vol. 34, No. 3, pp. 1342-1348, 0360-3199
- J. R. Rostrup-Nielsen, (2000). New aspects of syngas production and use, Vol. 63, No. 2-4, pp. 159-164, 0920-5861
- I. Dybkjr and T. S. Christensen. (2001). Syngas for large scale conversion of natural gas to liquid fuels, Studies in Surface Science and Catalysis, J. J. S. E. Iglesia and T. H. Fleisch, pp. 435-440, Elsevier, 0167-2991,

- J. L. Li and T. Inui, (1996). Enhancement in methanol synthesis activity of a copper/zinc/aluminum oxide catalyst by ultrasonic treatment during the course of the preparation procedure, Vol. 139, No. 1-2, pp. 87-96, 0926-860X
- B. J. Liaw and Y. Z. Chen, (2001). Liquid-phase synthesis of methanol from CO₂/H₂ over ultrafine CuB catalysts, Vol. 206, No. 2, pp. 245-256, 0926-860X
- Y. W. Wang, Z. L. Wang, J. F. Wang and Y. Jin, (2002). Study on the methanol synthesis in slurry reactors, Vol. 31, No. 8, pp. 597-601, 10008144 (ISSN)
- L. Sunggyu. (2007). Methanol Synthesis from Syngas, Handbook of Alternative Fuel Technology, Taylor & Francis Group,
- A. Cybulski, (1994). Liquid-phase methanol synthesis: Catalysts, mechanism, kinetics, chemical equilibria, vapor-liquid equilibria, and modeling - A review, Vol. 36, No. 4, pp. 557-615, 01614940 (ISSN)
- S. Lee, V. R. Parameswaran, I. Wender and C. J. Kulik, (1989). Roles of carbon dioxide in methanol synthesis, Vol. 7, No. 8, pp. 1021-1057,
- E. Fiedler, G. Grossmann, D. B. Kersebohm, G. Weiss and C. Witte. (2003). Ullmann's Encyclopedia of Industrial Chemistry Release 2003, Methanol, W.-V. V. G. C. KGaA, pp.
- K. Klier. (1982). Methanol Synthesis, Advances in Catalysis, H. P. D.D. Eley and B. W. Paul, pp. 243-313, Academic Press, 0360-0564,
- R. G. Herman. (1991). Chapter 7 Classical and Non-Classical Routes for Alcohol Synthesis, Studies in Surface Science and Catalysis, L. Guzzi, pp. 265-349, Elsevier, 0167-2991,
- P. L. Spath, D.C. Dayton (2003). Preliminary Screening and Economy Assessment of Synthesis fuels and Chemicals with Emphasis on the Potential for Biomass-Derived Syngas
- A. Haynes. (2006). Acetic Acid Synthesis by Catalytic Carbonylation of Methanol, Catalytic Carbonylation Reactions, M. Beller, pp. 179-205, Springer Berlin / Heidelberg,
- A. S. Merenov and M. A. Abraham, (1998). Catalyzing the carbonylation of methanol using a heterogeneous vapor phase catalyst, Vol. 40, No. 4, pp. 397-404, 0920-5861
- T. Yashima, Y. Orikasa, N. Takahashi and N. Hara, (1979). Vapor phase carbonylation of methanol over RhY zeolite, Vol. 59, No. 1, pp. 53-60, 0021-9517
- J. R. Zoeller, (2009). Eastman Chemical Company's "Chemicals from Coal" program: The first quarter century, Vol. 140, No. 3-4, pp. 118-126, 0920-5861
- H. Adkins and K. Folkers, (1931). The catalytic hydrogenation of Esters to alcohols, Vol. 53, No. 3, pp. 1095-1097, 0002-7863
- E. Chornet, B. Valsecchi, Y. Avilla, B. Nguyen, J-M. Lavoie, (2009). Production of ethanol to methanol, patent Application, WO20090326080
- H. Adkins, B. Wojcik and L. W. Covert, (1933). The Catalytic Hydrogenation of Esters to Alcohols. III, Vol. 55, No. 4, pp. 1669-1676, 0002-7863
- T. Turek, D. L. Trimm and N. W. Cant, (1994a). The Catalytic Hydrogenolysis of Esters to Alcohols, Vol. 36, No. 4, pp. 645-683, 0161-4940
- L. Xu and Y. Xu, (2010). Activation of methyl acetate on Pd(111), Vol. 604, No. 11-12, pp. 887-892, 0039-6028
- A. Corma, S. Iborra and A. Velty, (2007). Chemical Routes for the Transformation of Biomass into Chemicals, Vol. 107, No. 6, pp. 2411-2502, 0009-2665

- G. W. Huber, S. Iborra and A. Corma, (2006). Synthesis of Transportation Fuels from Biomass: Chemistry, Catalysts, and Engineering, Vol. 106, No. 9, pp. 4044-4098, 0009-2665
- A. Cybulski, J. Chrzyszcz and M. V. Twigg, (2001). Hydrogenation of dimethyl succinate over monolithic catalysts, Vol. 69, No. 1-4, pp. 241-245, 0920-5861
- D. J. Thomas, J. T. Wehrli, M. S. Wainwright, D. L. Trimm and N. W. Cant, (1992). Hydrogenolysis of diethyl oxalate over copper-based catalysts, Vol. 86, No. 2, pp. 101-114, 0926-860X
- T. Turek, D. L. Trimm, D. S. Black and N. W. Cant, (1994b). Hydrogenolysis of dimethyl succinate on copper-based catalysts, Vol. 116, No. 1-2, pp. 137-150, 0926-860X
- P. Claus, M. Lucas, B. Lücke, T. Berndt and P. Birke, (1991). Selective hydrogenolysis of methyl and ethyl acetate in the gas phase on copper and supported Group VIII metal catalysts, Vol. 79, No. 1, pp. 1-18, 0926-860X

IntechOpen



Biofuel's Engineering Process Technology

Edited by Dr. Marco Aurelio Dos Santos Bernardes

ISBN 978-953-307-480-1

Hard cover, 742 pages

Publisher InTech

Published online 01, August, 2011

Published in print edition August, 2011

This book aspires to be a comprehensive summary of current biofuels issues and thereby contribute to the understanding of this important topic. Readers will find themes including biofuels development efforts, their implications for the food industry, current and future biofuels crops, the successful Brazilian ethanol program, insights of the first, second, third and fourth biofuel generations, advanced biofuel production techniques, related waste treatment, emissions and environmental impacts, water consumption, produced allergens and toxins. Additionally, the biofuel policy discussion is expected to be continuing in the foreseeable future and the reading of the biofuels features dealt with in this book, are recommended for anyone interested in understanding this diverse and developing theme.

How to reference

In order to correctly reference this scholarly work, feel free to copy and paste the following:

Stéphane C. Marie-Rose, Alexis Lemieux Perinet and Jean-Michel Lavoie (2011). Conversion of Non-Homogeneous Biomass to Ultraclean Syngas and Catalytic Conversion to Ethanol, Biofuel's Engineering Process Technology, Dr. Marco Aurelio Dos Santos Bernardes (Ed.), ISBN: 978-953-307-480-1, InTech, Available from: <http://www.intechopen.com/books/biofuel-s-engineering-process-technology/conversion-of-non-homogeneous-biomass-to-ultraclean-syngas-and-catalytic-conversion-to-ethanol>

INTECH
open science | open minds

InTech Europe

University Campus STeP Ri
Slavka Krautzeka 83/A
51000 Rijeka, Croatia
Phone: +385 (51) 770 447
Fax: +385 (51) 686 166
www.intechopen.com

InTech China

Unit 405, Office Block, Hotel Equatorial Shanghai
No.65, Yan An Road (West), Shanghai, 200040, China
中国上海市延安西路65号上海国际贵都大饭店办公楼405单元
Phone: +86-21-62489820
Fax: +86-21-62489821

© 2011 The Author(s). Licensee IntechOpen. This chapter is distributed under the terms of the [Creative Commons Attribution-NonCommercial-ShareAlike-3.0 License](#), which permits use, distribution and reproduction for non-commercial purposes, provided the original is properly cited and derivative works building on this content are distributed under the same license.

IntechOpen

IntechOpen