

# We are IntechOpen, the world's leading publisher of Open Access books Built by scientists, for scientists

4,800

Open access books available

122,000

International authors and editors

135M

Downloads

Our authors are among the

154

Countries delivered to

TOP 1%

most cited scientists

12.2%

Contributors from top 500 universities



WEB OF SCIENCE™

Selection of our books indexed in the Book Citation Index  
in Web of Science™ Core Collection (BKCI)

Interested in publishing with us?  
Contact [book.department@intechopen.com](mailto:book.department@intechopen.com)

Numbers displayed above are based on latest data collected.

For more information visit [www.intechopen.com](http://www.intechopen.com)



# The Study of Details Effects in Cycling Aerodynamics: Comparison Between Two Different Experimental Approaches

Giuseppe Gibertini<sup>1</sup>, Gabriele Campanardi<sup>1</sup>, Donato Grassi<sup>1</sup>  
and Luca Guercilena<sup>2</sup>

<sup>1</sup>*Politecnico di Milano - Dipartimento di Ingegneria Aerospaziale*

<sup>2</sup>*Quick Step Pro Tour*

<sup>1</sup>*Italy*

<sup>2</sup>*Belgium*

## 1. Introduction

Aerodynamics is quite important for racing cyclists and particularly in time-trial competitions. In fact, the aerodynamic resistance, i.e. the breaking action of the relative wind, increases quadratically with the speed while the rolling resistance depends linearly on the speed (Kyle, 1989). Thus, due to the rather high velocity (in the order of 50 km/h), the aerodynamic resistance acting on a time-trial racer is about the 90% of the total resistance. Aerodynamics is thus very important for the cyclists performances and many experimental studies, addressed to find the best cyclist position as well as the best articles, have been carried out in the past (Garcia-Lopez et al., 2008; Gibertini & Grassi, 2008; Grappe et al., 1997; Lukes et al., 2005). Furthermore, although they are outside of the subject of the present treatise, some interesting computational works begin to appear in literature (see for example Defraeye et al. (2010a;b)).

### 1.1 The aerodynamic resistance

Following a widely used notation, the component of the aerodynamic force opposite to the bicycle motion is called  $F_x$  and its non-dimensional coefficient is  $C_x = F_x / (\frac{1}{2} \rho V_b^2 S)$  where  $\rho$  is the air density,  $V_b$  the bicycle speed and  $S$  a reference area that has to be defined. In absence of natural wind, all the relative wind is due to the bicycle motion and thus the force  $F_x$  corresponds to the aerodynamic drag and  $C_x$  is the drag coefficient.

For the typical racing velocities the coefficient  $C_x$  slightly depends on the Reynold number  $Re = \rho V_b \sqrt{S} / \mu$  (where  $\mu$  is the air viscosity) so that the drag is essentially proportional to the air density and to the square of the velocity (Basset et al., 1999). In order to avoid the arbitrary definition of  $S$  it can be more convenient to express the aerodynamic resistance in terms of drag area  $SC_x$  instead than in terms of non-dimensional drag coefficient. On the other hand, in order to compare the position aerodynamic efficiency of different cyclists apart from their different dimensions effect, the normalized resistance (i.e. the  $C_x$ ) can be interesting and in this case the projected frontal area can be taken as reference area (Heil, 2001 and 2002). More in general, when the drag of two or more bodies (whatever they are, men or objects) is compared, the decomposition of the drag area  $SC_x$  in terms of drag coefficient  $C_x$  and reference area  $S$

can help to evaluate how much a drag difference is due to a difference in the size or to a difference in the shape efficiency.

As reported by Gibertini & Grassi (2008), the time-trial cyclist overall  $C_x$  is slightly less than 1 (typically about 0.8) denoting that the cyclist is definitively a bluff body.

### 1.2 The testing methodologies

The experimental study of cycling aerodynamics is made difficult by the fact that the cyclists are not machines and their motion is not completely deterministic. As a matter of fact, although the motion of an elite cyclist is rather controlled and repeatable, nevertheless there are many possible differences (also in nominally equal positions) that can sensibly (and sometime strongly) affect the aerodynamic efficiency. The problem becomes more serious when the focus of the study is a detail effect as the effect of a bicycle part (handlebar, fork, wheels, etc.) or the effect of a particular of the cyclist dressing (as the shoes or the suit). In fact, the effects of that single details (Alam et al., 2008; Blair & Sidelko, 2008; Chabroux et al., 2008; Kyle, 1989; 1990; Sayer & Stanley, 1994; Tew & Sayers, 1999; Underwood & Jeremy, 2010) are often smaller than the global uncertainty of the drag measurement of a test involving the athlete (Flanagan, 1996).

It could be observed that so small effects, that can be easily masked from a slightly different position, are not so important for the cyclist performance. Nevertheless two considerations can be done: the first one is that also a small drag reduction can produce a sensible effect on the resulting race time (Kyle, 1989), and the second one is that an aerodynamic effect not strictly related to the cyclist position is anyway added to the global drag, independently to the capacity of the cyclist to keep the optimal position. Furthermore the sum of different small detail effects can results in a considerable value. Thus the problem of the better methodology for the study of this kind of detail effects is an important item for the cycling aerodynamics.

Generally speaking we can consider three possible experimental approaches. The first one is the wind tunnel testing of the single isolated detail: this way allows for very accurate and repeatable measurements and requires a relatively small wind tunnel (which means relatively low costs) but, on the other hand, the working condition of the isolated detail are not, in principle, the real working conditions. In principle tests can be carried out "in-field" as it has been done both directly on the road (Martin et al., 2006) and on a track (Gibertini, Campanardi, Guercilena & Macchi, 2010; Grappe et al., 1997). Unfortunately this tests are unavoidably affected by a considerable measurement uncertainty. In the middle between these two testing approaches, a third possible way is the wind tunnel testing including the real pedaling cyclist that surely produce more accurate results respect to the in-field testing. Nevertheless also wind tunnel results are affected by problems of repeatability.

An evaluation of the relative advantage and disadvantage of these three approaches is not simple. The present paper presents a reasoned comparison between the results obtained with "manned" wind tunnel testing and a partial model test (Gibertini, Grassi, Macchi & De Bortoli, 2010) on the effect of the overshoes.

### 1.3 Shoe testing

The choice of the shoes is a typical problem of the aerodynamic optimization of a time trial cyclist. Of course this choice depends on many aspects and not only on the aerodynamic point of view, but nevertheless it is interesting to evaluate the amount of drag (and thus the amount of power) due to the shoes. An interesting point that is a valid example to compare the two cited wind tunnel testing approaches is the effect of the overshoes: this accessories

are widely used in the time trial competitions with the aim of drag reduction. In the study already mentioned here before (Gibertini, Grassi, Macchi & De Bortoli, 2010) this subject was investigated by means of wind tunnel tests with a shank and foot model. These tests showed that the overshoes produce a drag increasing instead of a reduction. This counter-trend results could not be taken as conclusive because the tests were carried out on a static partial model (reproducing just the shank and the foot) that could not include all the real effects. A recent series of tests was carried out with an elite team of six cyclists. The aim of these tests was mainly the optimization of cyclists position (see Gibertini, Campanardi, Guercilena & Macchi (2010)) but it has been a precious occasion to get some confirmation of the results obtained with the shank and foot model.

## 2. The reference tests of overshoe effect on a partial model of foot and shank

The leading idea of the partial model tests was to represent, as well as possible, the working condition of the foot with a relatively simple setup (Gibertini, Grassi, Macchi & De Bortoli, 2010). The model was essentially a beam terminating with a shank model. The foot model was hinged to the shank in the ankle position. At the other extremity the beam was hinged to the balance interface. Thus, the model allowed to set both the angle of the shank and the angle of the foot. The shoe, put on the foot model, included the pedal. The test layout is shown in Fig. 1.

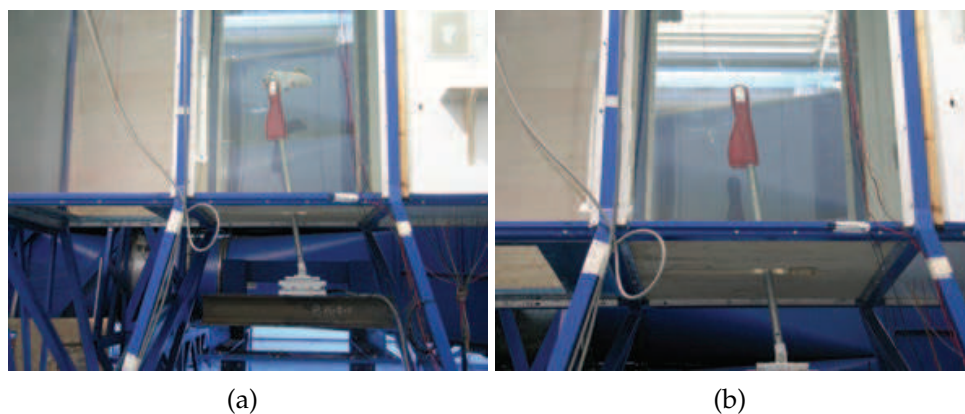

Fig. 1. The partial model test layout in the complete model configuration (a) and in foot-off tare configuration(b)

The test conditions have been defined on the base of shank and foot angles (defined as in Fig. 2a) at four pedaling phases  $\theta$  of a specific cyclist taken as reference example (the values are reported in Table 1). The shank and foot angles in the four reference positions have been deduced from the analysis of the frames of a video recorded during a previous "manned" wind tunnel test carried out in the Large Wind Tunnel of Politecnico di Milano. The obtained values have been taken as indicative as it was already clear that different cyclists have different angles of shank and foot (with differences that can be in the order of some degrees).

$\theta = 0^\circ$		$\theta = 90^\circ$		$\theta = 180^\circ$		$\theta = 270^\circ$	
$\epsilon_F$	$\epsilon_S$	$\epsilon_F$	$\epsilon_S$	$\epsilon_F$	$\epsilon_S$	$\epsilon_F$	$\epsilon_S$
$-22.9^\circ$	$49.3^\circ$	$8.6^\circ$	$80.8^\circ$	$-16.6^\circ$	$83.7^\circ$	$-40.7^\circ$	$40.7^\circ$

Table 1. Pedaling angle values assumed for the partial model test

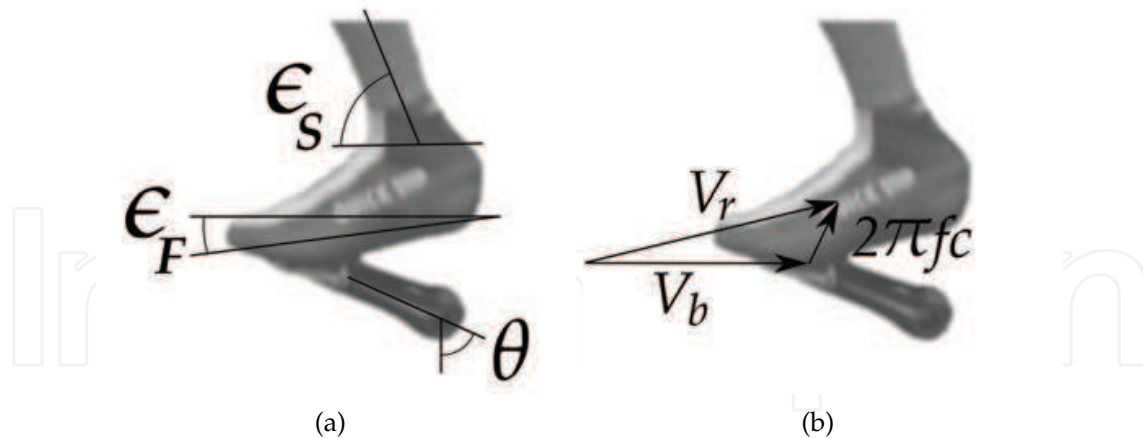

Fig. 2. Geometrical and kinematical quantities definition

These measured angles have been used to set the wind tunnel test conditions taking into account also the additional (positive or negative) incidence  $\alpha_p$  induced by the the foot vertical translation due to the pedaling (see Fig. 2b). Referring again to Fig. 2a,  $\Delta\epsilon = \epsilon_S - \epsilon_F$  while the relative velocity  $V_r$  and its incidence angle  $\alpha$  have been determined by the following Equation 1 and 2 where  $f$  is the pedaling frequency and  $c$  is the crank arm length.

$$V_r = \sqrt{(V_b + 2\pi f c \cos\theta)^2 + (2\pi f c \sin\theta)^2} \quad (1)$$

$$\alpha = \epsilon_F + \alpha_p; \quad \alpha_p = \arctan\left(\frac{2\pi f c \sin\theta}{V_b + 2\pi f c \cos\theta}\right) \quad (2)$$

The test conditions for the foot model, computed by means of Equations 1 and 2, are listed in the Table 2. The sketch of Fig. 3 illustrates the meaning of these quantities

$\theta = 0^\circ$		$\theta = 90^\circ$		$\theta = 180^\circ$		$\theta = 270^\circ$	
$V_r$	$\alpha$	$V_r$	$\alpha$	$V_r$	$\alpha$	$V_r$	$\alpha$
17.0 m/s	-22.9°	15.1 m/s	16.1°	13.0 m/s	-16.6°	15.1 m/s	-48.2°

Table 2. Test conditions set for the partial model test

The aerodynamic resistance is the force component  $F_x$  opposite to the bicycle motion (Equation 3).

$$F_x = \mathbf{F} \cdot \mathbf{V}_r \cos(\alpha_p) \quad (3)$$

The average resistance was computed taking the mean value of the four resistance values measured at the four different pedaling phases of Table 1.

Of course, the main limitation of this approach is that some interference effects with the other real components are missing (first of all the crank arms). An other possible objection is that also the real foot and shank dynamics is not completely reproduced: the incidence angle and the velocity are set to taken into account the motion due to pedal rotation but the rotation of the foot itself as well as the rotation of the shank are not reproduced. On the other hand, the measurements were quite accurate and repeatable indeed.

The tests were carried out assuming a reference riding condition of 15 m/s (i.e. 54 km/h) speed and 1.8 Hz pedaling frequency. Two different shoe models (one laced and one strap fastened) and the overshoe have been tested with two different pedal models. In order to obtain the

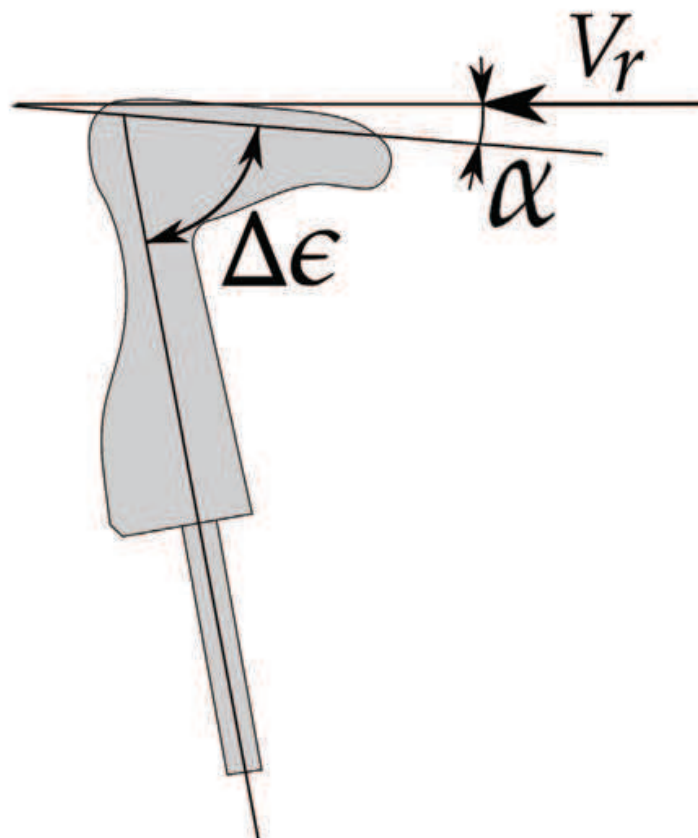

Fig. 3. The test parameters

aerodynamic loads acting on the foot only, previous aerodynamic tare tests with just the beam and the shank have been carried out as can be seen in Fig. 1b. The loads measured without the foot have been subtracted from the load measured with the complete model. One of the most curious results was the overshoe effect. In these test it resulted that the overshoe over a strap fastened shoe model produces an over drag for all the four tested phases as can be seen in Fig. 4 that shows the results obtained by Gibertini, Grassi, Macchi & De Bortoli (2010) for the strap fastened shoe model, with and without the overshoe, with a clipless single-sided pedal (33 mm high).

Taking the arithmetic mean of the four results related to the four phases, the measured drag area increase resulted to be equal to  $0.001 \text{ m}^2$  for each foot. The total amount of cyclist and bicycle drag area is in the order of  $0.2 \text{ m}^2$  (Defraeye et al., 2010a) thus the effect of the two overshoes is in the order of 1% of the total drag.

In order to verify the results of Gibertini, Grassi, Macchi & De Bortoli (2010), a new test campaign has been carried out using the same test conditions (as described here before) and using the same models (all the pictures of the partial model tests included in this chapter have been taken during this new test campaign). The new tests confirmed the results published in the cited journal paper. As in that reference work, the tests have been repeated with another pedal model obtaining essentially the same results: the drag area absolute values were slightly different as the pedals were different but the differences between different shoe models drag, as well as the difference due to the overshoe, were the same within a tolerance of  $10^{-4} \text{ m}^2$ .



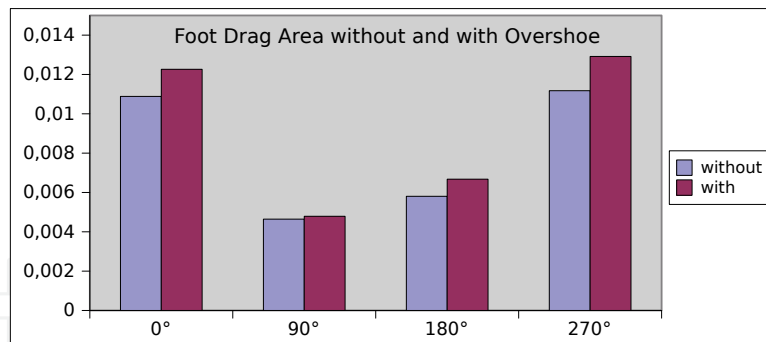

Fig. 4. Comparison between the foot drag areas without and with the overshoe at four different pedaling phases (drag areas expressed in  $m^2$ )

### 3. The manned wind tunnel tests of overshoe effect

The wind tunnel tests of the "complete system" (including the cyclist) were carried out in the large wind tunnel of Politecnico di Milano (Campanardi et al., 2003). This facility is equipped with a specific test rig for cycling aerodynamic tests. The test chamber is wide enough (Fig. 5) to get a negligible blockage effect: in fact, a typical value for the projected front area of a cyclist in time trial position is about  $0.3 m^2$  while the test section area in cycling test configuration is  $14.5 m^2$  leading to a solid blockage of about 2% that is an unusually low value (Defraeye et al., 2010a) assuring very low blockage effects (Barlow et al., 1999). Nevertheless, although it was very small indeed, blockage effect correction has been applied to the results following the procedure indicated in Barlow et al. (1999) for the case of unconventional shape.



Fig. 5. The wind tunnel test chamber

The test rig, that is in details described by Gibertini & Grassi (2008), allows to reproduce a realistic condition with the athlete pedaling and both wheels spinning (Fig. 6). The rear wheel axle is held by two vertical beams so that the wheel can spin over a small roller that, by means of a toothed belt, transmits the rotation to the front roller and finally to the front wheel; the front wheel axle is free so the cyclist has to drive the wheel as in a real condition. A brake system provides an adjustable resistance torque to the rollers producing a realistic effort and thus a realistic cyclist body attitude. A sketch of the test rig is shown in Fig. 7. The drag contribution of the support system (i.e. the aerodynamic tare) is measured in a test

run without rider and bicycle. The bicycle is equipped with a tachometer so that, during the test run, the cyclist is able to maintain the correct rotational speed of the wheels matching the wind velocity.



Fig. 6. Cyclist pedaling in the wind tunnel

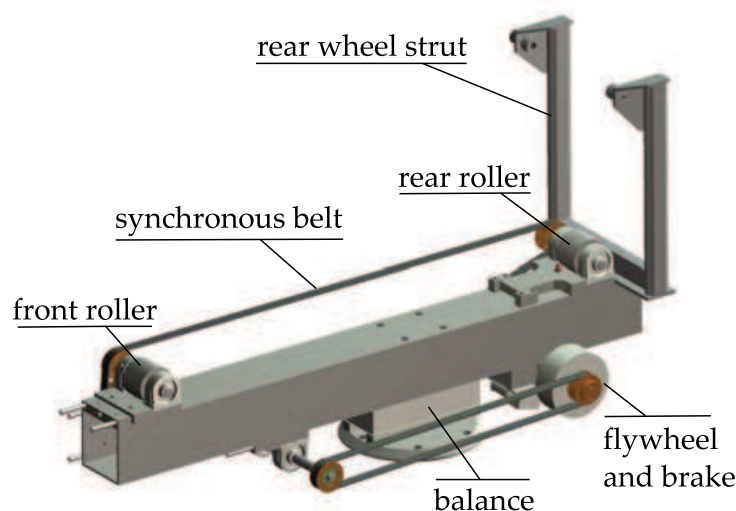

Fig. 7. The test rig for the cyclist

As mentioned before, the tests concerned a team of six cyclists with the aim of optimizing their position for time trial competitions. This gave the possibility to test the overshoe effect on a rather large base of athletes. The comparison with the reference tests of Gibertini, Grassi, Macchi & De Bortoli (2010) was made more meaningful by the fact that the most of these cyclists (four over six) adopted the same shoe model used in that study (Fig. 8a). The overshoe model was the same for all the six cyclists and was of the same kind of the one used in the partial tests (Fig. 9).

In Table 3 the anthropometric data of the six cyclists are listed, including the pedaling angles (see Fig. 2a for the definition) measured from the wind tunnel video-camera frame as showed in Fig. 10.



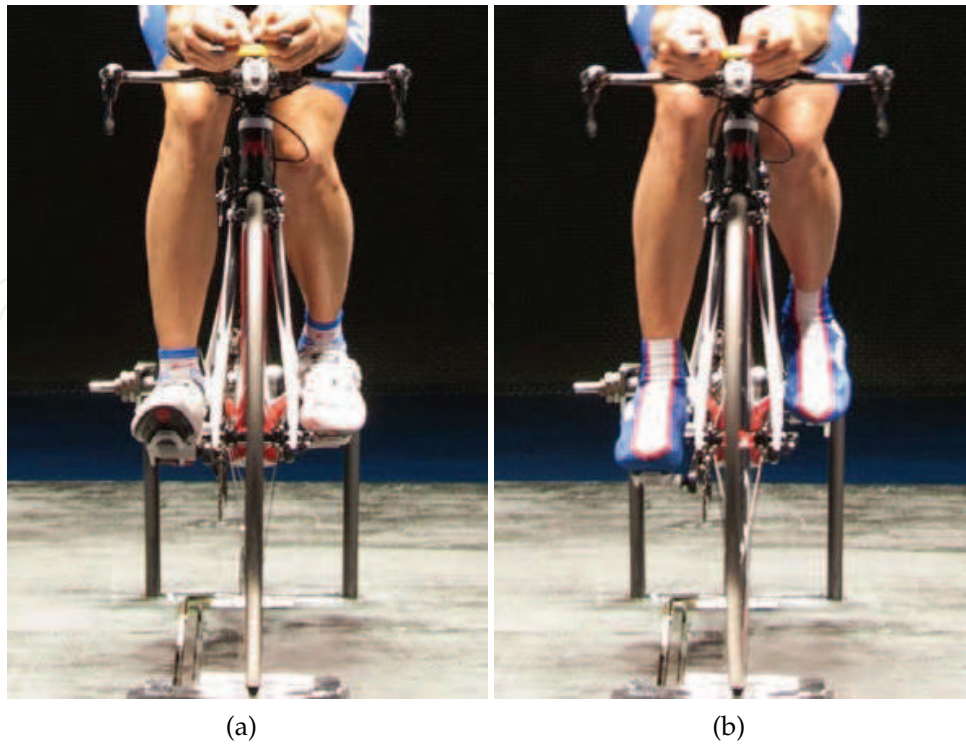

Fig. 8. Front view of cyclist legs without (a) and with (b) the overshoes



Fig. 9. The overshoe

By Equations 1 and 2 is possible to compute, for each cyclist and for each pedaling phases, the foot incidence  $\alpha$ . In Fig. 11 these incidences are plotted together and compared with the

Cyclist	Height	$\theta = 0^\circ$		$\theta = 90^\circ$		$\theta = 180^\circ$		$\theta = 270^\circ$		Shoe Size
		$\epsilon_F$	$\epsilon_S$	$\epsilon_F$	$\epsilon_S$	$\epsilon_F$	$\epsilon_S$	$\epsilon_F$	$\epsilon_S$	
AK	184 cm	-31°	39°	-2°	61°	-13°	66°	-52°	36°	43.5
TK	182 cm	-33°	48°	-6°	74°	-23°	76°	-59°	45°	43
KS	173 cm	-29°	41°	0°	66°	-21°	73°	-50°	39°	42.5*
DD	177 cm	-24°	47°	2°	72°	-21°	73°	-50°	42°	43.5
SD	182 cm	-29°	43°	-3°	67°	-24°	71°	-50°	41°	44
KD	182 cm	-29°	39°	-6°	64°	-19°	73°	-49°	38°	43*

\* different shoe models

Table 3. Cyclists anthropometric data

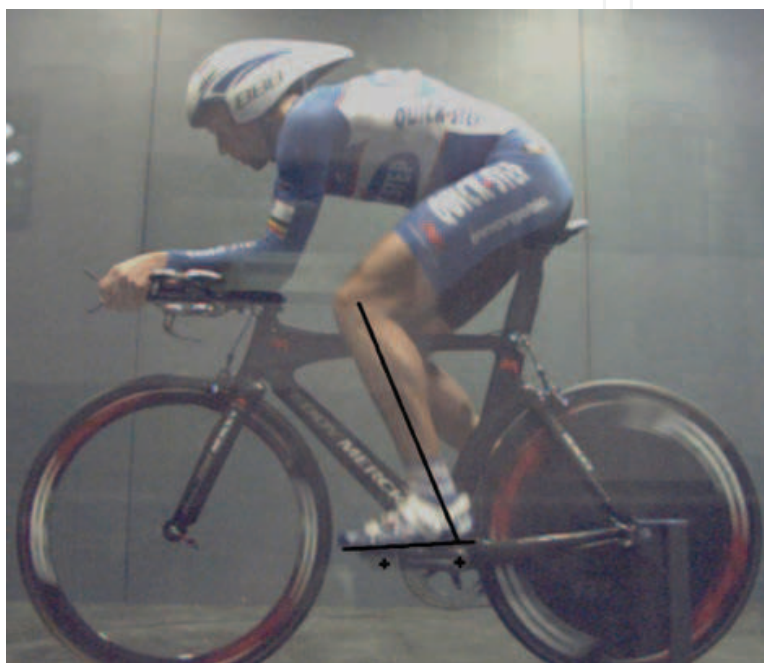

Fig. 10. Frame of the wind tunnel video-camera with drawn lines highlighting the pedaling angles

reference values used in the partial model tests.

As discussed in the introduction of the present paper, the manned tests are affected by a low degree of repeatability so that in principle, in order to obtain a result statistically meaningful, the test should be repeated several times. On the other hand the tests number are limited by reasons of wind tunnel costs and also by the fact that the cyclists tend to loose the concentration after too many repetitions (so that the result is not necessarily improving). In the present activity the cyclist position were tested twice, with any repetition test just subsequent to the first one, while the overshoes effect has been tested, for each cyclist, with an overshoes-on test just subsequent to an overshoe-off test at the same cyclist position (only for the cyclist KS the overshoe-on test preceded the other one). The single results is poorly meaningful as the chased effect is in the order of the test repeatability but the set of the all six data (one for each cyclist) gives a reasonable estimation of its order of magnitude.

Each test consisted in a 30 s acquisition at 12.5 m/s and, except for AK and TK, in a second acquisition at 13.9 m/s during the same wind tunnel run. As the two velocities are quite close each to the other so that the Reynolds number is essentially the same, for each test the

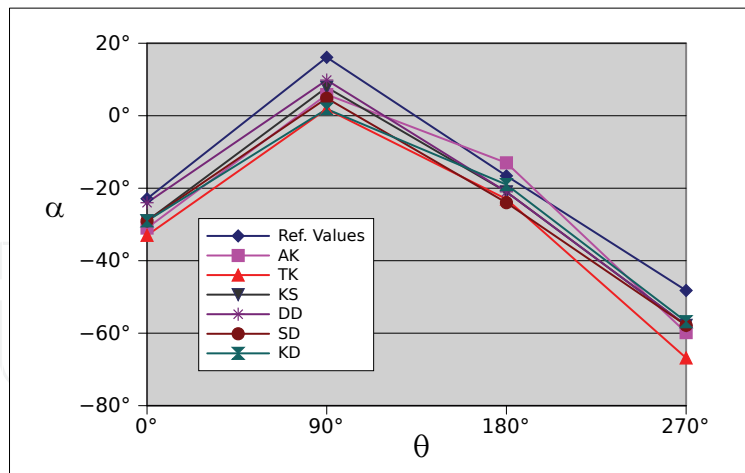

Fig. 11. Foot incidences

drag area was averaged over the two acquisitions (when applicable). The pedaling frequency was 1.5 Hz for 12.5 m/s and 1.7 Hz for 13.9 m/s. In Table 4 the measured values of  $\Delta SCx$  (the drag area increase due to the overshoes) are presented. The parameter RP, computed for each cyclist, is the root mean square of the differences between the drag areas measured in two related tests (a position tests and its repetition). Due to the small statistical base (from 3 to 5 positions tested for each cyclist) this parameter is only indicative but nevertheless gives a rough quantification of the test repeatability. It appears clear that the measured values of  $\Delta SCx$  are in the order of the tests uncertainty but nevertheless it is remarkable that in no one case the overshoes showed an advantage. The mean value (taking the mean of all the cyclist) resulted to be  $0.003 \text{ m}^2$  that, taking into account all the uncertainties, is quite well comparable with the value of  $0.002 \text{ m}^2$  obtained with the partial model tests. These results are summarized in Fig. 12.

Cyclist	$\Delta SCx$ [ $\text{m}^2$ ]	RP [ $\text{m}^2$ ]
AK	0.006	0.004
TK	0.004	0.006
KS	0.004	0.003
SD	0.001	0.003
KD	0.002	0.002
DD	0.001	0.002

Table 4. The overshoe effect

#### 4. Conclusions

The results of the present experimental investigation well highlight the difficulties of evaluating details effects by means of complete manned wind tunnel tests. The present investigation essentially confirmed the results obtained with the partial model: the overshoes produced an increase in the aerodynamic drag. Also the order of magnitude of the measured effect is essentially confirmed although the present manned tests are affected by a problem of repeatability that does not allow to estimate accurately such a small effect. Of course this degree of uncertainty does not allow to consider the present tests as a quantitative

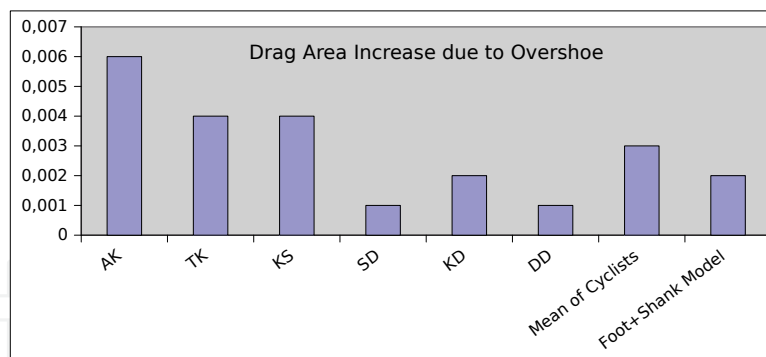

Fig. 12. The overshoe effect (drag areas expressed in  $m^2$ )

validation of the simplified test procedure but, nevertheless, the present results demonstrate that the complete manned configuration does not produce, respect to the simplified setup, any important aerodynamic effect that can drastically change the results. It can be concluded that, for the case of shoes aerodynamics, the partial test in a relatively small wind tunnel is a very reasonable way, more convenient respect to a more expensive and less accurate manned test. Of course this results is due to the fact that the adopted procedure and setup included all the main effects of the real condition and this was due to a reasoned approach but also to the fact that the foots are essentially undisturbed by the wake of the other components. This is not the case, for example, of the rear wheel that is completely immersed in the wakes of the cyclist legs and of the bicycle itself so that the drag measured by means of isolated wheel tests result to be not applicable to the real condition.

Generally speaking it is clear from the presented activity results that the question about the way for an accurate experimental definition of so small aerodynamic effects is still an open question.

## 5. References

- Alam, F., Subic, A. & Akbarzadeh, A. (2008). Aerodynamics of bicycle helmets, in M. Estivalet & P. Brisson (eds), *The Engineering of Sport 7, vol. 1*, Springer, Paris, pp. 337–344.
- Barlow, J., Rae, W. & Pope, A. (1999). *Low-speed wind tunnel testing*, Wiley and Sons, New York.
- Basset, D., Kyle, C., Passfield, L., Broker, J. & Burke, E. (1999). Comparing cycling world hour records, 1967-1996: modeling with empirical data, *Medicine & Science in Sports & Exercise* 31(11): 1665–1676.
- Blair, K. & Sidelko, S. (2008). Aerodynamic performance of cycling time trial helmets, in M. Estivalet & P. Brisson (eds), *The Engineering of Sport 7, vol. 1*, Springer, Paris, pp. 371–377.
- Campanardi, G., Gibertini, G., Pozzi, M. & Quici, M. (2003). La camera di prova aeronautica della galleria del vento del politecnico di milano (in italian), *Proceedings of XVII Congresso nazionale AIDAA*, Roma, Italy, pp. 2073–2077.
- Chabroux, V., Barelle, C. & Favier, D. (2008). Aerodynamics of time trial bicycle helmets, in M. Estivalet & P. Brisson (eds), *The Engineering of Sport 7, vol. 2*, Springer, Paris, pp. 401–410.
- Defraeye, T., Blocken, B., Koninckx, E., Hespel, P. & Carmeliet, J. (2010a). Aerodynamic study of different cyclist positions: Cfd analysis and full-scale wind-tunnel tests, *Journal of Biomechanics* 43(7): 1262–1268.



- Defraeye, T., Blocken, B., Koninckx, E., Hespel, P. & Carmeliet, J. (2010b). Computational fluid dynamics analysis of cyclist aerodynamics: Performance of different turbulence-modelling and boundary-layer modelling approaches, *Journal of Biomechanics* 43(12): 1262–1268.
- Flanagan, M. (1996). Considerations for data quality and uncertainty in testing of bicycle aerodynamics, *Cycling Science* 8(1): 7–10 and 22–23.
- Garcia-Lopez, J., Rodriguez-Marroyo, J., Juneau, C., Peleteiro, J., Cordova Martinez, A. & Villa, J. (2008). Reference values and improvement of aerodynamic drag in professional cyclists, *Journal of Sports Sciences* 26(3): 277–286.
- Gibertini, G., Campanardi, G., Guercilena, L. & Macchi, C. (2010). Cycling aerodynamics: wind tunnel testing versus track testing, in J. Goh Cho Hong (ed.), *6th World Congress of Biomechanics (WCB 2010), IFBME Proceedings 31*, Springer, pp. 10–13.
- Gibertini, G. & Grassi, D. (2008). Cycling aerodynamics, in H. Nørstrud (ed.), *Sport Aerodynamics, CISM Courses and Lectures, vol.506*, Springer, Wien, pp. 23–47.
- Gibertini, G., Grassi, D., Macchi, M. & De Bortoli, G. (2010). Cycling shoe aerodynamics, *Sports Engineering* 12(3): 155–161.
- Grappe, F., Candau, R., Belli, A. & Rouillon, J. (1997). Aerodynamic drag in field cycling with special reference to the obree's position, *Ergonomics* 40(12): 1299–1311.
- Heil, D. (2001). Body mass scaling of projected frontal area in competitive cyclists, *European Journal of Applied Physiology* 85(3-4): 358–366.
- Heil, D. (2002). Body mass scaling of frontal area in competitive cyclists not using aero-handlebars, *European Journal of Applied Physiology* 87(6): 520–528.
- Kyle, C. (1989). The aerodynamics of handlebars & helmets, *Cycling Science* 1(1): 22–25.
- Kyle, C. (1990). Windtunnel tests of bicycle wheels & helmets, *Cycling Science* 2(1): 27–30.
- Lukes, R., Chin, S. & Haake, S. (2005). The understanding and development of cycling aerodynamics, *Sports Engineering* 8(2): 59–74.
- Martin, J., Gardner, A., Barras, M. & Martin, D. (2006). Aerodynamic drag area of cyclists determined with field-based measures, *Sportscience* 10: 68–69.
- Sayer, A. & Stanley, P. (1994). Drag force on rotating racing cycle wheels, *Journal of Wind Engineering and Industrial Aerodynamics* 53(3): 431–440.
- Tew, G. & Sayers, A. (1999). Aerodynamics of yawed racing cycle wheels, *Journal of Wind Engineering and Industrial Aerodynamics* 82(1): 209–222.
- Underwood, L. & Jeremy, M. (2010). Optimal hand position for individual pursuit athletes, in A. Sabo, P. Kafka, S. Litzenberger & C. Sabo (eds), *The Engineering of Sport 8 - Engineering Emotion, Procedia Engineering*, vol.2, Elsevier, Amsterdam, pp. 2425–2429.



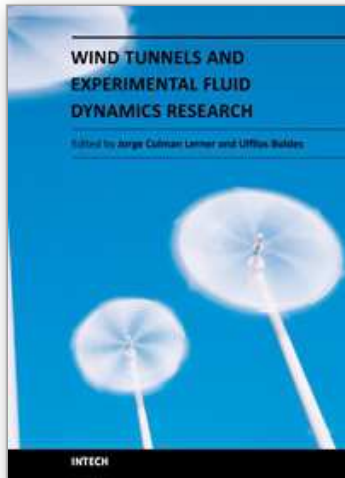

## Wind Tunnels and Experimental Fluid Dynamics Research

Edited by Prof. Jorge Colman Lerner

ISBN 978-953-307-623-2

Hard cover, 709 pages

**Publisher** InTech

**Published online** 27, July, 2011

**Published in print edition** July, 2011

The book "Wind Tunnels and Experimental Fluid Dynamics Research" is comprised of 33 chapters divided in five sections. The first 12 chapters discuss wind tunnel facilities and experiments in incompressible flow, while the next seven chapters deal with building dynamics, flow control and fluid mechanics. Third section of the book is dedicated to chapters discussing aerodynamic field measurements and real full scale analysis (chapters 20-22). Chapters in the last two sections deal with turbulent structure analysis (chapters 23-25) and wind tunnels in compressible flow (chapters 26-33). Contributions from a large number of international experts make this publication a highly valuable resource in wind tunnels and fluid dynamics field of research.

### How to reference

In order to correctly reference this scholarly work, feel free to copy and paste the following:

Giuseppe Gibertini, Gabriele Campanardi, Donato Grassi and Luca Guercilena (2011). The Study of Details Effects in Cycling Aerodynamics: Comparison between Two Different Experimental Approaches., Wind Tunnels and Experimental Fluid Dynamics Research, Prof. Jorge Colman Lerner (Ed.), ISBN: 978-953-307-623-2, InTech, Available from: <http://www.intechopen.com/books/wind-tunnels-and-experimental-fluid-dynamics-research/the-study-of-details-effects-in-cycling-aerodynamics-comparison-between-two-different-experimental-a>

**INTECH**  
open science | open minds

### InTech Europe

University Campus STeP Ri  
Slavka Krautzeka 83/A  
51000 Rijeka, Croatia  
Phone: +385 (51) 770 447  
Fax: +385 (51) 686 166  
[www.intechopen.com](http://www.intechopen.com)

### InTech China

Unit 405, Office Block, Hotel Equatorial Shanghai  
No.65, Yan An Road (West), Shanghai, 200040, China  
中国上海市延安西路65号上海国际贵都大饭店办公楼405单元  
Phone: +86-21-62489820  
Fax: +86-21-62489821

© 2011 The Author(s). Licensee IntechOpen. This chapter is distributed under the terms of the [Creative Commons Attribution-NonCommercial-ShareAlike-3.0 License](#), which permits use, distribution and reproduction for non-commercial purposes, provided the original is properly cited and derivative works building on this content are distributed under the same license.

IntechOpen

IntechOpen