

# We are IntechOpen, the world's leading publisher of Open Access books Built by scientists, for scientists

4,800

Open access books available

122,000

International authors and editors

135M

Downloads

Our authors are among the

154

Countries delivered to

TOP 1%

most cited scientists

12.2%

Contributors from top 500 universities



WEB OF SCIENCE™

Selection of our books indexed in the Book Citation Index  
in Web of Science™ Core Collection (BKCI)

Interested in publishing with us?  
Contact [book.department@intechopen.com](mailto:book.department@intechopen.com)

Numbers displayed above are based on latest data collected.  
For more information visit [www.intechopen.com](http://www.intechopen.com)



# A Dynamic Context Reasoning based on Evidential Fusion Networks in Home-based Care

Hyun Lee<sup>1</sup>, Jae Sung Choi<sup>2</sup> and Ramez Elmasri<sup>3</sup>

<sup>1</sup>Daegu Gyeongbuk Institute of Science & Technology

<sup>2,3</sup>University of Texas at Arlington

<sup>1</sup>South Korea

<sup>2,3</sup>USA

## 1. Introduction

During emergency situations of the patient in home-based care, a Pervasive Healthcare Monitoring System (PHMS) (Lee et al., 2008) is significantly overloaded with pieces of information of different known reliability or unknown reliability. The pieces of the information should be processed, interpreted, and combined to recognize the situation of the patient as accurate as possible. In such a context, the information obtained from different sources such as multi-sensors and Radio Frequency Identification (RFID) devices can be imperfect due to the imperfection of the information itself or unreliability of the sources. In order to deal with different aspects of the imperfection of contextual information, we proposed an evidential fusion network based on Dezert-Smarandache Theory (DSmT) (Dezert & Smarandache, 2009) as a mathematical tool in (Lee et al., 2009). However, context reasoning over time is a difficult in an emergency context, because unpredictable temporal changes in sensory information may happen (Rogova & Nimier, 2004). The (Lee et al., 2009) did not consider dynamic metrics of the context. In addition, some types of contextual information are more important than others. A high respiratory rate may be a strong indication of the emergency of the patient others may not be so important to estimate that specific situation (Padovitz et al., 2005; Wu et al., 2003). The weight of this information may change, due to the aggregation of the evidence and the variation of the value of the evidence over time. For instance, a respiratory rate (e.g., 50 Hz) at current time-indexed state ( $S_t$ ) should have more weight compared to a respiratory rate (e.g., 21 Hz) at previous time-indexed state ( $S_{t-1}$ ), because 50 Hz indicates the emergency situation of the patient strongly (Campos et al., 2009; Danninger & Stierelhagen, 2008).

Thus, we propose a Dynamic Evidential Network (DEN) as a context reasoning method to estimate or infer future contextual information autonomously. The DEN deals with the relations between two consecutive time-indexed states of the information by considering dynamic metrics: temporal consistency and relation-dependency of the information using the Temporal Belief Filtering (TBF) algorithm. In particular, we deal with both relative and individual importance of evidence to obtain optimal weights of evidence. By using the proposed dynamic normalized weighting technique (Valiris et al., 2005), we fuse both intrinsic and optional context attributes. We then apply dynamic weights into the DEN in order to infer the situation of the patient based on temporal and relation dependency. Finally,

we compare the proposed fusion process with a fusion process based on Dempster-Shafer Theory (DST) (Wu et al., 2003) and Dynamic Bayesian Networks (DBNs) (Murphy, 2002) that has the same assumption of the environments, so as to show the improvement of our proposed method in an emergency situation of the patient. The main contributions of the proposed context reasoning method under uncertainty based on evidential fusion networks are: 1) Reducing the conflicting mass in uncertainty level and improving the confidence level by adapting the DS<sub>m</sub>T, 2) Distinguishing the sensor reading error from new sensor activations or deactivations by considering the TBF algorithm, and 3) Representing optimal weights of the evidence by applying the normalized weighting technique into related context attributes. These advantages help to make correct decisions about the situation of the patient in home-based care.

The rest of the chapter is organized as follows. Basics of context reasoning are introduced in section 2. In section 3, we introduce a dynamic context reasoning method based on evidential fusion network. In section 4, we perform a case study so as to distinguish the proposed fusion process with traditional fusion processes. We compare and analyze the results of our approach with those of DST and DBNs to show the improvement of our approach in section 5. We introduce some related works in section 6. We then conclude this work in section 7.

## 2. Basics of context reasoning

### 2.1 Characteristics of the evidence

Multi-sensors such as medical body sensors, Radio Frequency Identification (RFID) devices, environmental sensors and actuators, location sensors, and time stamps are utilized in a PHMS (Lee et al., 2008). These sensors are operated by pre-defined rules or learning processes of the expert systems. They often have thresholds to represent the emergency status of the patient or to operate actuators. Each sensor can be represented by an evidential form such as 1 (active) and 0 (inactive) based on the threshold. Whenever the state of a certain context associated with a sensor is changed, the value of a sensor can change from 0 to 1 or from 1 to 0. For instance, a medical body sensor activates the emergency signal if the sensor value is over the pre-defined threshold. An environmental sensor operates the actuator based on the fuzzy systems. A location detecting sensor operates if a patient is within the range of the detection area. Thus, we can simply express the status of each sensor as a frame:  $\Theta = \{Threshold_{over}, Threshold_{not-over}\} = \{1, 0\}$ .

Sensor data are inherently unreliable or uncertain due to technical factors and environmental noise. Different types of a sensor may have various discounting factors ( $D$ ) ( $0 \leq D \leq 1$ ). Hence we can express the degree of reliability, which is related in an inverse way to the discounting factor. The smaller reliability ( $R$ ) corresponds to a larger discounting factor ( $D$ ):

$$R = 1 - D \quad (1)$$

For inferring the activity of the patient based on evidential theory, reliability discounting methods that transform beliefs of each source are used to reflect the sensor's credibility, in terms of discount factor ( $D$ ) ( $0 \leq D \leq 1$ ). The discount mass function is defined as:

$$m^D(X) = \begin{cases} (1 - D)m(X) & X \subset \Theta \\ D + (1 - D)m(\Theta) & X = \Theta \end{cases} \quad (2)$$

where the source is absolutely reliable ( $D = 0$ ), the source is reliable with a discounting factor ( $D$ ) ( $0 < D < 1$ ), and the source is completely unreliable ( $D = 1$ ).

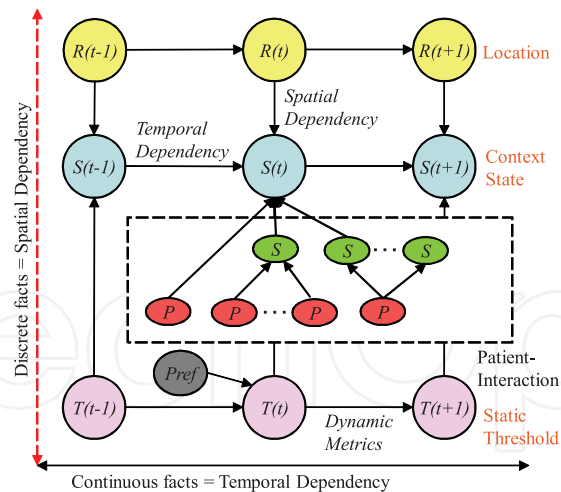

Fig. 1. A Relation-dependency approach

## 2.2 Context classification

The quality of a given piece of contextual information of a patient should be presented by some generalized forms of context classification (Razzaque et al., 2007) to determine reliable contextual information of a patient. However, it is an impossible task to build a general context classification to capture all aspects of the patient's contextual information in smart spaces. The numbers of ways to describe an event or an object are unlimited and there are no standards or guidelines regarding granularity of contextual information. In particular, the quality of a given piece of contextual information is not guaranteed by uncertainty. Thus, we defined the relation-dependency approach as a context classification based on spatial-temporal limitations which has three categories: 1) discrete environmental facts; 2) continuous environmental facts; and 3) occupant-interaction events as shown in Figure 1. These relation-dependency components consist of "Context state ( $S(t)$ )", defined as the collection and aggregation of activated or deactivated context attributes (Lee et al., 2009), "Sensor's static threshold ( $T(t)$ )", "Location of the patient ( $R(t)$ )", "Primary context ( $P$ )", "Secondary context ( $S$ )" and "Preference ( $Pref$ )".

## 2.3 Context modeling

We defined a state-space based context modeling with an evidential form as a generalized context modeling to represent the situation of the patient using context concepts that are similarly used in (Padovitz et al., 2005) and to improve the quality of a given piece of contextual information by reducing uncertainty. Within the proposed modeling, all possible values and their ambiguous combinations are considered to improve the quality of data in the given time ( $t$ ) and location ( $R$ ). We assign a probability value to each related set to achieve an efficient uncertainty representation. This can transfer a qualitative context information to a quantitative representation. Static weighting factors of the selected data are applied to represent the quality of data initially within the given  $t$  and  $R$ . This context modeling consists of a hierarchical interrelationship among multi-sensors, related contexts, and relevant activities within a selected region as shown in Figure 2. Each context concept is defined as follow.

A *context attribute*, denoted by  $\alpha_i$ , is defined as any type of data that is utilized in the process of inferring situations. It is often associated with sensors, virtual or physical, where the value of a sensor reading denotes the value of a context attribute at a given  $t$ , denoted by  $\alpha_i^t$ .

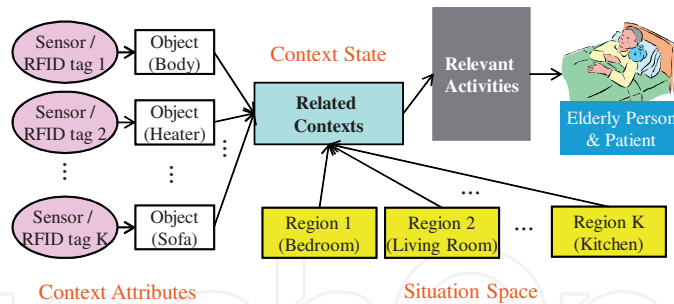

Fig. 2. An inter-relationship based on state-space context modeling

A *context state*, denoted by a vector  $S_i$ , describes the current state of the applied application in relation to a chosen context. It is a collection of  $N$  context attribute values to represent a specific state of the system at the given  $t$ . A context state is denoted as  $S_i^t = (\alpha_1^t, \alpha_2^t, \dots, \alpha_N^t)$ , where each value  $\alpha_i^t$  corresponds to the value of an attribute  $\alpha_i$  at the given  $t$ . Whenever contextual information is recognized by certain selected sensors that can be used to make context attributes, a context state changes its current state depending on the aggregation of these context attributes.

A *situation space*, denoted by a vector space  $R_i = (\alpha_1^R, \alpha_2^R, \dots, \alpha_K^R)$ , describes a collection of regions corresponding to some pre-defined situations. It consists of  $K$  acceptable regions for these attributes. An acceptable region  $\alpha_i^R$  is defined as a set of elements  $V$  that satisfies a predicate  $P$ , (i.e.,  $\alpha_i^R = V \setminus P(V)$ ). A particular contextual information can be performed or associated with a certain selected region.

Given a context attribute  $i$ , a *quality of data*  $\psi_i$  associates weights  $\omega_1, \omega_2, \dots, \omega_M$  with combined attributes of values  $\alpha_1^t + \alpha_1^R, \alpha_2^t + \alpha_2^R, \dots, \alpha_N^t + \alpha_N^R$  of  $i$ , respectively, where  $\sum_{j=1}^M \omega_j = 1$ . The weight  $\omega_j \in (0, 1]$  represents the relative importance of a context attribute  $\alpha_j$  compared to other context attributes in the given  $t$  and  $R$ . For instance, a higher respiratory rate may be a strong indication of the fainting situation of a patient while other context attributes such as the blood pressure and the body temperature may not be so important to estimate that specific situation of the patient. In addition, a context attribute ( $\alpha_i^t$ ) within a context state ( $S_i^t = (\alpha_1^t, \alpha_2^t, \dots, \alpha_N^t)$ ) has various individual weights for  $\alpha_i^t$  per different time intervals in the same situation space ( $\alpha_i^R$ ). For example, a respiratory rate (50Hz) at the current time-indexed state ( $S_t$ ) is a strong indication of the fainting situation of the patient compared to a respiratory rate (21Hz) at previous time-indexed state ( $S_{t-1}$ ). The same context attribute can have different degrees of importance in different contexts. We only consider the quality of data with the pre-defined context attributes, a selected region, and relevant activities initially. We then apply dynamic weights into both relative and individual importance of evidence to obtain an optimal weight of evidence.

## 2.4 Dezert-Smarandache Theory (DSmT)

The basic idea of DSmT (Dezert & Smarandache, 2004; 2006; 2009) is to consider all elements of  $\Theta$  as not precisely defined and separated. No refinement of  $\Theta$  into a new finer set  $\Theta^{ref}$  of disjoint hypotheses is possible in general, unless some integrity constraints are known, and in such case they will be included in the DSm model of the frame. Shafer's model (Shafer, 1976) assumes  $\Theta$  to be truly exclusive and appears only as a special case of the DSm hybrid model in DSmT. The hyper-power set, denoted by  $D^\Theta$ , is defined by the rules 1, 2 and 3 without additional assumption on  $\Theta$  but the exhaustivity of its elements in DSmT.

1.  $\emptyset, \theta_1, \dots, \theta_n \in D^\Theta$
2. If  $\theta_1, \theta_2 \in D^\Theta$ , then  $\theta_1 \cap \theta_2$  and  $\theta_1 \cup \theta_2$  belong to  $D^\Theta$
3. No other elements belong to  $D^\Theta$ , except those obtained by rules 1) or 2)

When Shafer's model  $M^0(\Theta)$  holds,  $D^\Theta$  reduces to  $2^\Theta$ . Without loss of generality,  $G^\Theta$  is equal to  $D^\Theta$  if the DSm model is used, depending on the nature of the problem.

### 2.5 Combination rules (conjunctive and disjunctive)

As a conjunctive combination rule, the proportional conflict redistribution no. 5 (PCR5) (Smarandache & Dezert, 2005) are defined based on the conjunctive consensus operator for two sources cases by:

$$m_{12}(X) = \sum_{\substack{X_1, X_2 \in G^\Theta \\ X_1 \cap X_2 = X}} m_1(X_1)m_2(X_2) \quad (3)$$

The total conflicting mass drawn from two sources, denoted by  $k_{12}$ , is defined as:

$$k_{12} = \sum_{\substack{X_1, X_2 \in G^\Theta \\ X_1 \cap X_2 = \emptyset}} m_1(X_1)m_2(X_2) = \sum_{\substack{X_1, X_2 \in G^\Theta \\ X_1 \cap X_2 = \emptyset}} m(X_1 \cap X_2) \quad (4)$$

The total conflicting mass is the sum of partial conflicting masses based on Equations (3) and (4). If the total conflicting mass  $k_{12}$  is close to 1, the two sources are almost in total conflict. Whereas if the total conflicting mass  $k_{12}$  is close to 0, the two sources are not in conflict.

Within the DSmT framework, the PCR5 combination rule redistributes the partial conflicting mass only to the elements involved in that partial conflict. For this approach, first, the PCR5 combination rule calculates the conjunctive rule of the belief masses of sources. Second, it calculates the total or partial conflicting masses. And last, it proportionally redistributes the conflicting masses to nonempty sets involved in the model according to all integrity constraints. The PCR5 combination rule is defined for two sources (Dezert & Smarandache, 2009):  $m_{PCR5}(\emptyset) = 0$  and  $\forall(X \neq \emptyset) \in G^\Theta$ ,

$$m_{PCR5}(X) = m_{12}(X) + \sum_{\substack{Y \in G^\Theta \setminus \{X\} \\ X \cap Y = \emptyset}} \left[ \frac{m_1(X)^2 m_2(Y)}{m_1(X) + m_2(Y)} + \frac{m_2(X)^2 m_1(Y)}{m_2(X) + m_1(Y)} \right] \quad (5)$$

where  $m_{12}$  and all denominators such as  $m_1(X) + m_2(Y)$  and  $m_2(X) + m_1(Y)$  differ from zero(0). If a denominator is zero, that fraction is discarded. All sets in formulas are in canonical forms. For example, the canonical form of  $X = (A \cap B) \cap (A \cup B \cup C)$  is  $A \cap B$ .

In addition, a disjunctive combination rule is used for Temporal Belief Filtering (TBF) (Ramasso et al., 2006). For instance, the TBF, which reflects that only one hypothesis concerning activity is true at each time-indexed state, ensures a temporal consistency with an exclusivity. Within a TBF, the disjunctive rule of combination ( $m_\cup(\cdot)$ ) is used so as to compute prediction from previous mass distributions and model of evolution.  $m_\cup(\cdot)$  is defined for two sources:  $m_\cup(\emptyset) = 0$  and  $\forall(C) \subset \Theta$ ,

$$m_\cup(C) = \sum_{\substack{i,j \\ C = X_i \cup Y_j}} m_1(X_i)m_2(Y_j), \quad \forall(C \neq \emptyset) \in \Theta \quad (6)$$

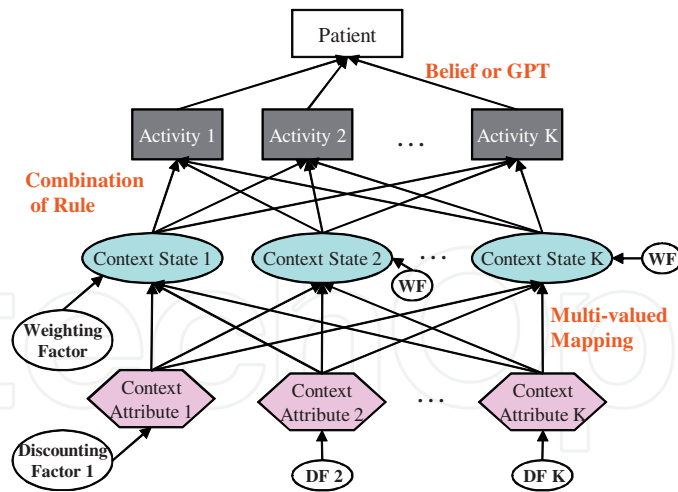

Fig. 3. An Evidential Fusion Network (EFN)

The core of a belief function given by  $m_U(C)$  equals the union of the cores of  $Bel(X)$  and  $Bel(Y)$ . This rule reflects the disjunctive consensus and is usually preferred when one knows that one of the source  $X$  or  $Y$  is mistaken but without knowing which one between  $X$  and  $Y$ .

## 2.6 Pignistic transformations (CPT and GPT)

When a decision must be taken, the expected utility theory, which requires a classical pignistic transformation (CPT) from a basic belief assignment  $m(\cdot)$  to a probability function  $P\{\cdot\}$ , is defined in (Dezert et al., 2004) as follows:

$$P\{A\} = \sum_{X \in 2^\Theta} \frac{|X \cap A|}{|X|} m(X) \quad (7)$$

where  $|A|$  denotes the number of worlds in the set  $A$  (with convention  $|0|/|0| = 1$ , to define  $P\{0\}$ ).  $P\{A\}$  corresponds to  $BetP(A)$  in Smets' notation (Smets, 2000). Decisions are achieved by computing the expected utilities. In particular, the maximum of the pignistic probability is used as a decision criterion.

Within the DSMT framework, it is necessary to generalize the CPT to take a rational decision. This generalized pignistic transformation (GPT) is defined by (Dezert et al., 2004):  $\forall(A) \in D^\Theta$ ,

$$P\{A\} = \sum_{X \in D^\Theta} \frac{C_M(X \cap A)}{C_M(X)} m(X) \quad (8)$$

where  $C_M(X)$  denotes the DSMT cardinal of a proposition  $X$  for the DSMT model  $M$  of the problem under consideration. In this case, if we adopt Shafer's model  $M^0(\Theta)$ , Equation (8) reduces to Equation (7) when  $D^\Theta$  reduces to  $2^\Theta$ . For instance, we get a basic belief assignment with non null masses only on  $X_1$ ,  $X_2$  and  $X_1 \cup X_2$ . After applying GPT, we get:

$$\begin{aligned} P\{\emptyset\} &= 0, & P\{X_1 \cap X_2\} &= 0 \\ P\{X_1\} &= m(X_1) + \frac{1}{2}m(X_1 \cup X_2) \\ P\{X_2\} &= m(X_2) + \frac{1}{2}m(X_1 \cup X_2) \\ P\{X_1 \cup X_2\} &= m(X_1) + m(X_2) + m(X_1 \cup X_2) = 1 \end{aligned}$$

## 2.7 Evidential Fusion Network (EFN)

Based on the proposed state-space context modeling, the Evidential Fusion Network (EFN) is constructed as shown in Figure 3. Within a EFN, context reasoning is performed to make a high confidence level of the situation of the patient. The fusion process is performed to infer the activity of the patient along the EFN as follows.

1. (Define the Frame of Discernment): the evidential form represents all possible values of the sensors and their combination values.
2. (Sensor's Credibility): reliability discounting mass functions defined as Equations (1) and (2) transform beliefs of individual evidence to reflect the credibility of the sensor. A discounting factor ( $D$ ) is applied to each context attribute within an EFN.
3. (Multi-valued Mapping): a multi-valued mapping represents the evidence to the same problem with different views. In particular, it can be applied to the context attributes so as to represent the relationships between sensors and associated objects by translating mass functions. A multi-valued mapping also can be applied to the related context state so as to represent the relationships among context attributes. Each context state consists of different pre-defined static weight of the evidence (*Relative importance*).
4. (Consensus): several independent sources of the evidence combine the belief mass distributions on the same frame to achieve the conjunctive consensus with the conflict mass. The PCR5 combination rule (Smarandache & Dezert, 2005) is applied to context states to obtain a consensus that helps to recognize the activity of the patient.
5. (Degree of Belief): Lower (*Belief (Bel)*) and upper bounds (*Plausibility (Pl)*) on probability is calculated to represent the degree of belief. Then the uncertainty levels ( $Pl - Bel$ ) of the evidence in evidential framework is measured by using belief functions such as *Belief (Bel)* and *Plausibility (Pl)* after applying the PCR5 combination rule.
6. (Decision Making): The expected utility and the maximum of the pignistic probability such as Generalized Pignistic Transformations (GPT) is used as a decision criterion. The situation of the patient is inferred by calculating the belief, uncertainty, and confidence (i.e., GPT) levels of contextual information within an EFN.

## 3. Dynamic context reasoning

As shown in Figure 4, contextual information of a patient has the association or correlation between two consecutive time-indexed states. The EFN should include a temporal dimension for dealing with this context reasoning over time. Therefore, we introduce a dynamic context reasoning method in this section.

### 3.1 Temporal Belief Filtering (TBF) for relation-dependency

Depending on temporal changes, the values of the sensor at the current time-indexed state ( $S_t$ ) are evolved by the measured values at the previous time-indexed state ( $S_{t-1}$ ), because the belief mass distribution can not vary abruptly between two consecutive time-indexed states. In order to deal with this evolution, we utilize the Autonomous Learning Process (ALP) principle that has three states: 1) Initial State, 2) Reward State, and 3) Final Decision State as shown in Figure 5. This ALP principle is performed based on the Q-learning technology represented by (Roy et al., 2005). In Equation (9),  $X_t$  is the current state,  $m(\cdot)$  is the belief mass distribution,  $D$  is the discounting factor, and  $Re$  is the reward state to help decision making in



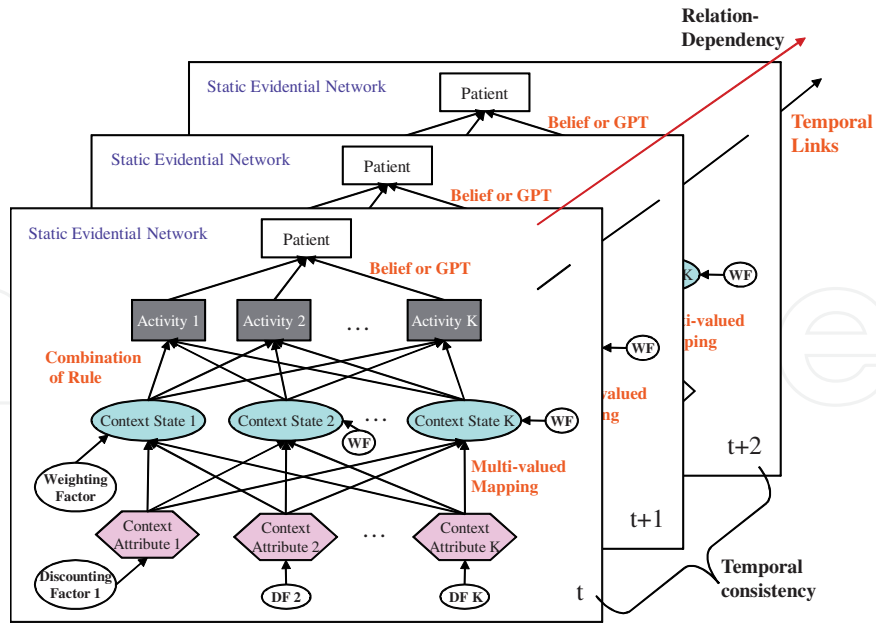

Fig. 4. EFN with a temporal dimension

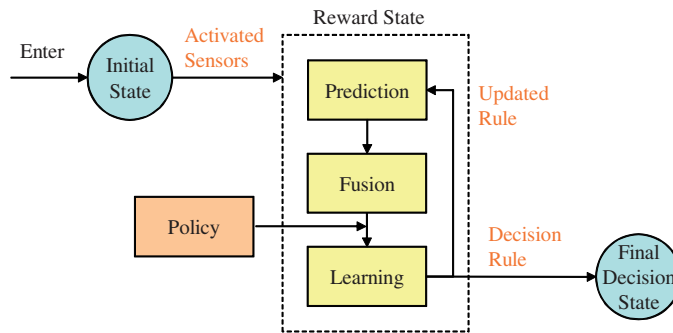

Fig. 5. Autonomous Learning Process (ALP) Principle

final decision state. We can support dynamic metrics (e.g., the evolution of the upper bounds or lower bounds of the pre-defined criteria).

$$Q(X_t, m_t(\cdot)) \leftarrow (1 - m_t(\cdot))Q(X_t, m_t(\cdot)) + m_t(\cdot)(Re + D \max m_{t-1}(\cdot)Q(X_{t-1}, m_{t-1}(\cdot))) \tag{9}$$

In particular, TBF operations: prediction, fusion, learning and update are performed in reward state of the ALP principle to obtain the relation-dependency. The TBF ensures temporal consistency with the exclusivity between two consecutive time-indexed states when only one hypothesis concerning activity is true at each time. The TBF assumes that the general basic belief assignment (GBBA) at the current time stamp  $t$  is close to the GBBA at the previous time stamp  $t - 1$ . Based on this assumption, the evolution process predicts a current GBBA taking the GBBA at  $t - 1$  into account. The TBF that operates at each time stamp  $t$  consists in four steps: 1) Prediction, 2) Fusion, 3) Learning and 4) Updated rule if required. For instance, if the activity of the patient was fainting ( $F$ ) at  $t - 1$  then it would be partially fainting ( $F$ ) at  $t$ . This is an implication rule for fainting ( $F$ ) which can be weighted by a confidence value of  $m_F\{\cdot\} \in [0, 1]$ . In this case, the vector notation of a GBBA defined on the frame of discernment ( $\Theta$ ) is used:

$$m^\Theta = [ m^\Theta(\emptyset) \quad m^\Theta(\neg F) \quad m^\Theta(F) \quad m^\Theta(\neg F \cup F) ]$$

The evolution process can be interpreted as a GBBA defined as:

$$m_F^\ominus = [ 0 \quad 1 - Pl_F \quad Bel_F \quad Pl_F - Bel_F ]^T \quad (10)$$

### 3.1.1 Prediction

Depending on current model  $M$  with only two focal sets, the disjunctive rule of combination is used to compute *prediction* from the previous GBBA at  $t - 1$  and model of evolution using Equation (6). The disjunctive rule of combination does not allow to assign more belief to a hypothesis than does the previous GBBA. It is well suited for the autonomous evolution process under uncertainty:

$$\hat{m}_{t,M}^\ominus = m_{t-1}^\ominus (M \cup) m_M^\ominus \quad (11)$$

where  $m_{t-1}^\ominus$  is the previous GBBA and  $m_M^\ominus$  is model of evolution.

For instance, the prediction for fainting ( $F$ ) situation of the patient at time stamp  $t$  is defined as:

$$\hat{m}_{t,F}^\ominus = \begin{bmatrix} 0 \\ (1 - Pl_F) \times m_{t-1}^\ominus(\neg F) \\ Bel_F \times m_{t-1}^\ominus(F) \\ 1 - [(1 - Pl_F) \times m_{t-1}^\ominus(\neg F) + Bel_F \times m_{t-1}^\ominus(F)] \end{bmatrix} \quad (12)$$

when  $m_F = 1$  or when  $m_F = 0$ , the prediction reflects a total confidence or a total ignorance with the current time-indexed state, respectively.

### 3.1.2 Fusion, learning and updated rule

*Prediction* ( $\hat{m}_{t,M}^\ominus$ ) and *measurement* ( $m_t^\ominus$ ) represent two distinct pieces of the information. *Fusion* of the two distinct pieces of the information leads to a new GBBA whose conflict value ( $C_F$ ) is relevant for belief learning and update requirement. In this case, conflict value ( $C_F$ ), which is similar to  $k_{12}$  of Equation (4), is calculated by the conjunctive rule of combination of  $\hat{m}_{t,M}^\ominus$  and  $m_t^\ominus$ :

$$C_F = \hat{m}_{t,M}^\ominus (M \cap) m_t^\ominus (\emptyset) \quad (13)$$

In addition, *policy* is required so as to analyze whether the current model  $M$  is valid or not. If  $C_F$  is not greater than the pre-defined threshold ( $T$ ), the model at  $t - 1$  is kept as valid at  $t$ . However, if  $C_F$  exceeds the  $T$ , the model is evolved based on the result of the conjunctive rule of combination of  $\hat{m}_{t,M}^\ominus$  and  $m_t^\ominus$ . Depending on the applied policy, the evolution process ( $m_{t,M}^\ominus$ ) (i.e., *learning*) is performed as below:

$$m_{t,M}^\ominus = \begin{cases} \hat{m}_{t,M}^\ominus (M \cap) m_t^\ominus, & \text{if } C_F \geq T \\ m_{t-1,M}^\ominus, & \text{if } C_F < T \end{cases} \quad (14)$$

After a learning, a fading memory process ( $F_a$ ) has been embedded so as to reduce the relation-dependency of the pieces of long past information even though the cumulative sum of conflict value ( $C_F$ ) between  $\hat{m}_{t,M}^\ominus$  and  $m_t^\ominus$  is lower than the pre-defined threshold ( $T$ ) during long time intervals. A fading memory process ( $F_a$ ) resets the cumulative sum of  $C_F$  as a zero (0) and  $\hat{m}_{t+w,M}^\ominus$  is equal to  $m_{t+w}^\ominus$  based on time window size ( $W$ ), which is chosen as a constant value ( $C$ ). Then, *updated rule* is applied to the model of evolution repeatedly after  $F_a$  is applied to  $m_{t,M}^\ominus$ .

$$m_{t+w,M}^\ominus = \begin{cases} (1) & F_a \leftarrow \begin{cases} \sum C_F = 0 \\ \hat{m}_{t+w,M}^\ominus = m_{t+w}^\ominus \end{cases}, \text{if } W = C \\ (2) & m_{t,M}^\ominus \times (F_a) \end{cases} \quad (15)$$

### 3.1.3 Decision rule

A decision is taken by the maximum of GPT (i.e., Equation (8)) within the DSMT framework after the evolution process is performed. We adopt Shafer's model (Shafer, 1976) in order to compare our approach with DBNs, which can get a BBA with non null masses only on  $\theta_1$  and  $\theta_2$  (i.e.,  $P\{\theta_1 \cup \theta_2\} = m(\theta_1) + m(\theta_2) = 1$ ) where  $\theta_1$  and  $\theta_2$  are hypotheses of the frame of discernment ( $\Theta$ ) (i.e., focal elements of the state within the frame of the set).

It is required to assess the recognition performance of a time-indexed state to decide whether a temporal sequence of the state has a false alarm or a new sensor activation/deactivation within the defined time window size ( $W$ ). It is necessary to find a quality criterion without references to assess this performance. We defined  $D_F$  as the differentiation of GPTs of two consecutive time-indexed states. The  $\bar{D}_F$  is defined as the mean of  $D_F$  (i.e.,  $\frac{\sum D_F}{W}$ ) within the defined  $W$  as the chosen criterion (i.e., Equation (16)) in order to distinguish a sensor reading error from new sensor activations or deactivations. As shown in Equation (17), if  $\bar{D}_F$  is less than  $\delta$ , there is no error within  $W$ . If  $\bar{D}_F$  is located between  $\delta$  and  $\gamma$ , a false alarm happens. And if  $\bar{D}_F$  is greater than  $\gamma$ , the emergency situation of the patient progress.

$$\bar{D}_F \triangleq \frac{1}{W} \sum_{i=1, W} D_F^i \quad (16)$$

$$Decision(De) = \begin{cases} \text{No errors within the } W, & \text{if } \bar{D}_F < \delta \\ \text{False alarm} & \text{,if } \delta \leq \bar{D}_F < \gamma \\ \text{Emergency Progress} & \text{,if } \gamma \leq \bar{D}_F \end{cases} \quad (17)$$

where  $\delta$  is the defined false alarm threshold and  $\gamma$  is the defined emergency progress threshold for the chosen criterion. In this case, the value of  $\delta$  is always lower than that of  $\gamma$ , because we assume that the false alarm does not often happen when the new sensor activation or deactivation is detected by the expert system in emergency situation of the patient. Based on the defined threshold ( $T$ ) for conflict value ( $C_F$ ) and time window size ( $W$ ), we can distinguish a sensor reading error from new sensor operations. Then, we perform evolution operations with dynamic evidential network (DEN) in order to improve the confidence (i.e., GPT) level of contextual information.

### 3.2 Evolution operations with DEN

The DEN is constructed based on the EFN with a temporal dimension as shown in Figure 6. Within a DEN, context reasoning is performed to find a false alarm in captured contexts and to make a high confidence level of the situation of the patient. First, we define the threshold ( $Te$ ) of the GPT level for the emergency situation of the patient. Second, we calculate the GPT level at each time-indexed state using a TBF with defined  $T$  and  $W$ . And last, if the GPT level is over the defined  $Te$  for four continuous time-indexed states, we make a decision about the situation of the patient as an emergency. We assume that the initial prediction is equal to the 1<sup>st</sup> measurement at 1<sup>st</sup> time-indexed state ( $S_1$ ). The consecutive processing of two combination rules (i.e, disjunctive rule and conjunctive rule) is well adapted to EFN to update the belief mass distribution of EFN at time-indexed states. In Figure 6, we define  $n$  time intervals and time window sizes  $W$  to reflect a fading memory process ( $F_a$ ) to the pervasive healthcare system. The  $F_a$  reduces long past contextual information of the patient. Depending on  $D_F$  and  $\bar{D}_F$ , we trace the emergency progress which can check a false alarm. We then make an optimal time window size ( $W$ ) that is applied to the evolution process.

IntechOpen

Context Type	Sensor Type	Non-Activated		
		Regular (1)	Warning (2)	Warning (3)
Intrinsic	Respiratory Rate	15~20 Hz	13~14 or 21~30 Hz	11~12 or 31~40 Hz
	Blood Pressure	120~90 mmHg	121~130 or 81~89 mmHg	131~140 or 71~80 mmHg
	Body Temperature	36.6~37 °C	36.1~36.5 or 37.1~38 °C	35.6~36 or 38.1~39 °C
Optional	Location	The motion detector installed in the ceiling catches the RF signal		
	Motion	The motion detector installed in the door catches the RF signal		
	Pressure	The pressure sensor attached on the sofa catches the weight		

Table 1. Pre-defined Rules of a Context Attribute

IntechOpen

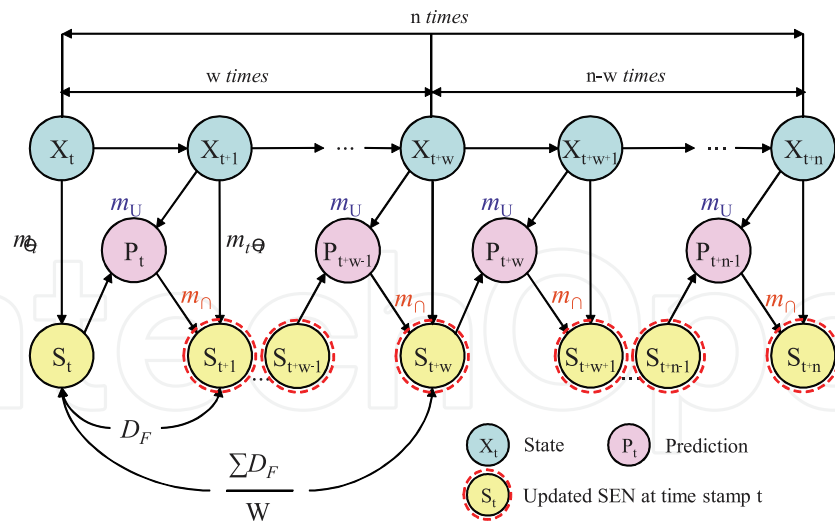

Fig. 6. The Proposed DEN for  $n$  time intervals

### 3.3 An optimal weight for evidence

#### 3.3.1 Pre-defined rule of a context attribute

We define rules of a context attribute to represent dynamic weights of a context attribute as shown in Table 1. We assume that the ratio of total weights of optional context attributes  $O(\sum \omega_i)$  is equal to that of intrinsic context attributes  $I(\sum \omega_i)$  in order to apply the rule of combination. Within a EFN, each context state has the same weight (e.g., the weight is equal to 0.5). We apply more  $C(a_t^k)$ , which reflects the increase or decrease degree of a particular context attribute, to the activated case (i.e., Emergency (4)) compared to the non-activated case (i.e., Warning (2 and 3) and Regular (1)), because the activated case is more important than the non-activated case in an emergency situation of the patient. In addition, we apply more  $C(a_t^k)$  to the level increased case (i.e.,  $L(a_{t+1}^k) > L(a_t^k)$ ) compared to the level decreased case (i.e.,  $L(a_{t+1}^k) < L(a_t^k)$ ), where  $L(a_{t+1}^k)$  reflects the level of a particular context attribute. The level increased case is more important than the level decreased case in an emergency situation of the patient. Thus, we calculate the weight of an intrinsic context attribute as below.

1. initial  $O(\sum \omega_i) = I(\sum \omega_i) = 0.5$
2. if all  $L(a_t^k) = L(a_{t+1}^k)$ , then  $C(a_{t+1}^k) = 0$
3. else if  $L(a_{t+1}^k) > L(a_t^k)$  and  $L(a_{t+1}^k) \neq 4$ , then  $C(a_{t+1}^k) = 2\alpha$
4. else if  $L(a_{t+1}^k) < L(a_t^k)$  and  $L(a_t^k) \neq 4$ , then  $C(a_{t+1}^k) = -\alpha$
5. else if  $L(a_{t+1}^k) > L(a_t^k)$  and  $L(a_{t+1}^k) = 4$ , then  $C(a_{t+1}^k) = 3\beta$
6. else if  $L(a_{t+1}^k) < L(a_t^k)$  and  $L(a_t^k) = 4$ , then  $C(a_{t+1}^k) = -2\beta$

with two % values  $\alpha$  and  $\beta$  (i.e.,  $\beta \geq \alpha$ ).

#### 3.3.2 A normalized weighting technique

We calculate the relative weight of a context attribute based on Multi-Attribute Utility Theory (MAUT) (Valiris et al., 2005; Winterfeld & Edwards, 1986) to setup the initial weight of a context attribute within a given context state. The weights are determined by their importance in regarding to a specific situation of the patient. In particular, we construct a scale

Sensor Type	Regular	Emergency	Relative Weight $\tilde{\omega}_u$
Respiratory Rate	Scale-R (5)	Scale-E (55)	0.6
Blood Pressure	Scale-R (5)	Scale-E (15)	0.2
Body Temperature	Scale-R (5)	Scale-E (15)	0.2
Location	Scale-R (5)	Scale-E (10)	0.25
Motion	Scale-R (5)	Scale-E (10)	0.25
Pressure	Scale-R (5)	Scale-E (25)	0.50

Table 2. An example of Relative Weight of a Context Attribute

representing the properties of the levels of a context attribute to evaluate context attributes. For instance, we assume that the scale from 0 (e.g., the least affection) to 55 (e.g., the most affection) for the situation serves as measure of the evaluation as shown in Table 2. We pre-define the scale of a context attribute then calculate the relative importance of a context attribute using Equation (18).

$$\tilde{\omega}_u = \omega_v / \sum_{w=1}^N (\omega_w) \quad (18)$$

where  $\tilde{\omega}_u$  defines the relative weight of a context attribute,  $\omega_v$  is the sum of the value of Scale-R and Scale-E for one sensor type, and  $\sum_{w=1}^N (\omega_w)$  is the total sum of the value of Scale-R and Scale-E. After calculating the relative weight of a context attribute, we redistribute the weight of a context attribute over time based on the pre-defined rule of a context attribute. Let  $\omega_1, \omega_2, \dots, \omega_k, \dots, \omega_{k+m}, \dots, \omega_N$  denote an initial relative weight associated with a given context state  $S_i^j$  for fusion process. Within the same location, a normalized weighting technique for individual difference between two time-indexed states is applied to each context attribute as below.

1. Repeat for each optional context attribute  $k$ :  
 $\omega_k = \omega_i$ , where  $i$  defines an initial weight
2. Repeat for each intrinsic context attribute  $k$ :  
 if all  $L(a_t^k) = L(a_{t+1}^k)$  or all  $C(a_{t+1}^k)$  are equal,  
 then all  $\omega_k = \omega_i$   
 else if any  $L(a_t^k) \neq L(a_{t+1}^k)$  or any  $C(a_{t+1}^k)$  is different,  
 then  $\hat{\omega}_k = \omega_i / \sum_{j=1}^N (\omega_j \pm C(a_{t+1}^j))$ ,  
 where  $\hat{\omega}_k$  defines a new weight for a context attribute

### 3.4 Dynamic context reasoning

Based on the proposed DEN, the dynamic weighting is applied to each evidence to make a high GPT level of the situation of the patient compared to the others. First, we calculate the GBBA of SEN initially using evidential operations at 1<sup>st</sup> time-indexed state. Second, we apply the updated weight into each context attribute from 2<sup>nd</sup> time-indexed state using the proposed normalized weighting technique. Finally, we calculate the confidence level (i.e., GPT) of contextual information. The procedures of dynamic context reasoning consist of seven steps.

1. (Measure a GBBA of SEN): Initially, we measure a GBBA of SEN using evidential operations at time stamp  $t$ . The first prediction ( $\hat{m}_{t_1, M}^\ominus$ ) is equal to measurement ( $m_{t_1}^\ominus$ ) at time-indexed state  $S_1$ .

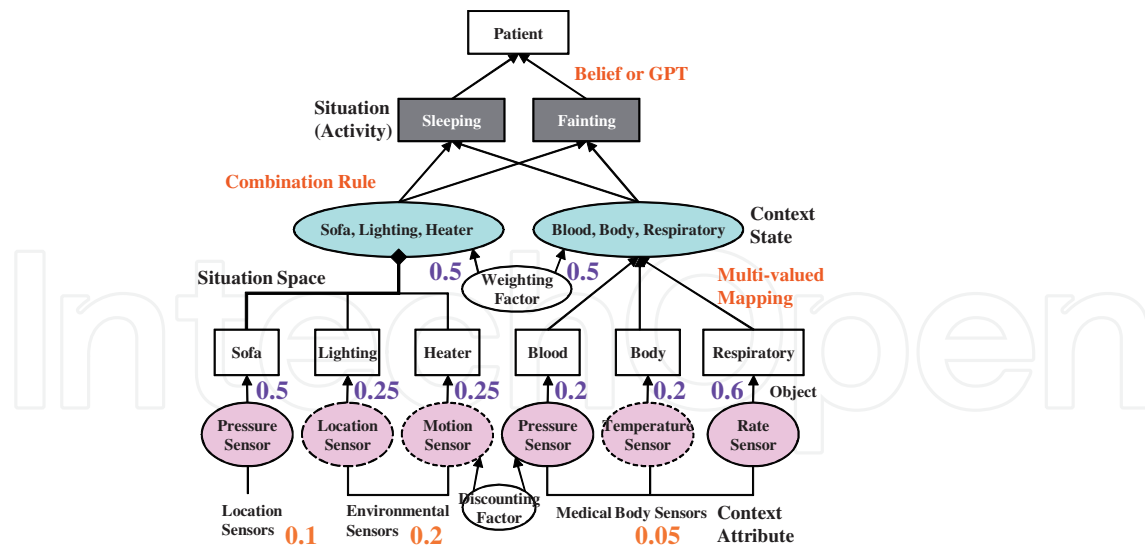

Fig. 7. An example of a patient's situation based on the EFN

2. (Update the Weight of a Context Attribute): First, we calculate the relative importance of a context attribute. Second, we redistribute the weight of a context attribute over time based on the pre-defined rule of a context attribute. Third, we calculate individual difference between two time-indexed states using the proposed normalized weighting technique (i.e., Equation (18)). And last, we apply the updated weight into each context attribute from  $2^{nd}$  time-indexed state so as to obtain the GPT of contextual information.
3. (Prediction and Evolution): We calculate prediction from the previous GBBA and model of evolution using the disjunctive rule of combination (i.e., Equation (6)). The disjunctive rule of combination is well suited for the model evolution under uncertainty because it does not allow to assign more belief to an hypothesis than does the previous GBBA. The GBBA of SEN at time stamp  $t + 1$  will be affected by prediction ( $\hat{m}_{t+1,M}^{\ominus}$ ).
4. (Learning): We fuse  $\hat{m}_{t+1,M}^{\ominus}$  and  $m_{t+1}^{\ominus}$  using the conjunctive rule of combination so as to make a new GBBA. As a learning, if a conflict value ( $C_F$ ) is greater than the pre-defined threshold ( $T$ ), a new GBBA is adapted. Whereas, the previous learned GBBA is adapted as a new GBBA (i.e., Equation (14)).
5. (Fading Memory Process): We apply a fading memory process ( $F_a$ ) with the defined time window size ( $W$ ) so as to reduce the affection of long past information. After  $F_a$  is performed, the GBBA of  $\hat{m}_{t+w,M}^{\ominus}$  is equal to the GBBA of  $m_{t+w}^{\ominus}$  (i.e., Equation (15)). The previous GBBA of  $\hat{m}_{t+w-1,M}^{\ominus}$  is ignored at time stamp  $t+w$ .
6. (Update and Decision Making): We calculate each GPT of the frame of discernment per time-indexed state (i.e., Equation (8)) by applying the updated rule then calculate differentiation ( $D_F$ ) of two consecutive time-indexed states. Based on the mean of  $D_F$  (i.e.,  $\bar{D}_F$ ) and the pre-defined value for  $\delta$  and  $\gamma$ , we can make a decision: No errors, False alarm, or Emergency progress (i.e., Equation (17)).
7. (Comparison the GPT level): Finally, we compare the GPT level of consecutive time-indexed states. If the GPT level is over the pre-defined threshold ( $T_e$ ), which represents the emergency situation, for four continuous time-indexed states, we make a decision about the situation of the patient as an emergency.

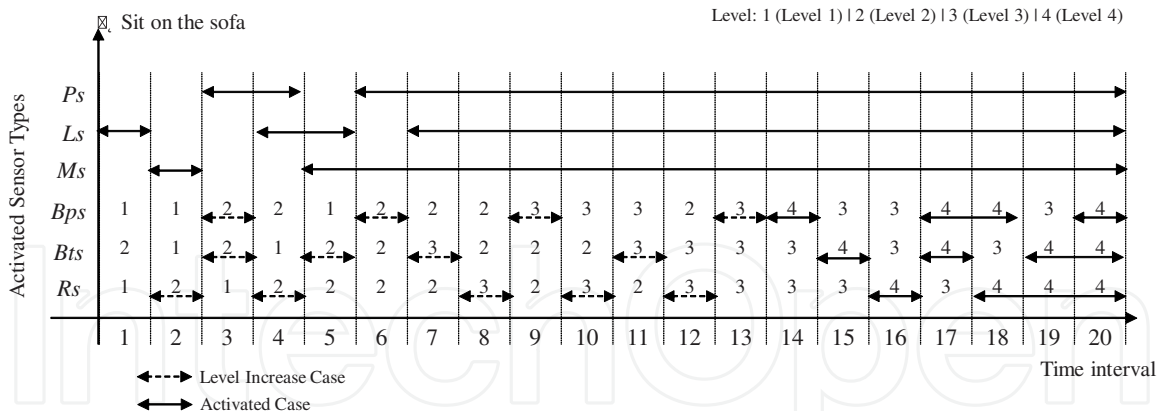

Fig. 8. An example of emergency level changes based on time intervals

% value	Case 1	Case 2	Case 3	Case 4	Case 5	Case 6
$\beta$	5 %	10 %	15 %	20 %	25 %	30 %
$\alpha$	5 %	5 %	10 %	10 %	15 %	30 %

Table 3. An example of the % values of  $\alpha$  and  $\beta$

#### 4. A case study

As shown in Figure 7, many ambiguous situations of the patient can happen in home-based care. We suppose that the situation (i.e., "sleeping" (*Sl*) or "fainting" (*F*)) of the patient can happen in smart home applications. In order to check dynamic emergency level changes based on time intervals, six types of a sensor are randomly activated during 20 time intervals as shown in Figure 8. Among six types of a sensor, three types of a sensor: blood pressure, body temperature and respiratory rate are involved in an intrinsic context attribute type. Whereas three types of a sensor: pressure, location and motion are involved in an optional context attribute type. Within Figure 8, we apply the level increased case and the activated case based on the data of Table 1. Initially, a discounting factor and a relative weight of each sensor are fixed so as to calculate the initial GBBA of EFN. In particular, we assume that a discounting factor of the environmental sensors, the location sensor, and the medical body sensors are 20%, 10% and 5%, respectively. We can obtain an initial relative weight of each sensor using a scale representing method as shown in Table 2. We apply different % values of  $\alpha$  and  $\beta$  (i.e.,  $\beta \geq \alpha$ ) as shown in Table 3 to check the variations of the weight depending on the selected degree of a level change ( $C(a_{t+1}^k)$ ). For making a simulation, we perform an evidential fusion process with a 95% confidence interval for 500 iterations. Moreover, we use paired observations (Jain, 1991) that construct a confidence interval for the difference in order to compare our method with other methods such as DST and DBNs. The analysis of paired observations deals with two processes as one process of  $n$  pairs. For each pair, the difference in performance can be computed. Then, if the confidence interval includes zero, two fusion processes are not significantly different.

#### 5. Comparison and analysis

We compare the uncertainty levels of two cases: 1) DST and 2) DSMT and the GPT levels of two cases: 1) DSMT and 2) DBNs. For calculating the "fainting (*F*)" situation of the patient within the applied scenario, we apply three methods: 1) defined static weighting factors, 2) different weighting factors and 3) different discounting factors into the two fusion processes,



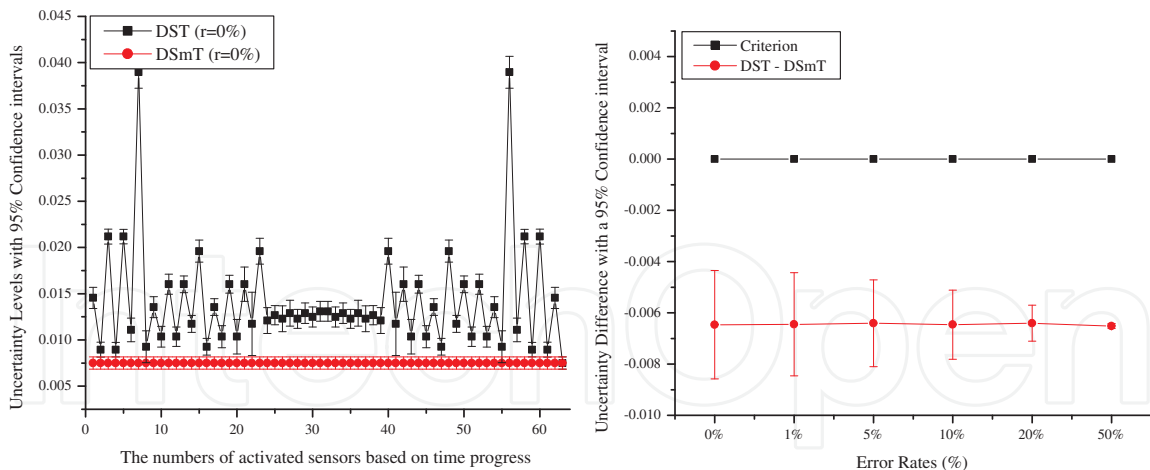

(a) Uncertainty levels of two cases with  $r=0\%$  (b) Comparison Uncertainty levels of two cases

Fig. 9. Comparison Uncertainty Levels of DSMT and DST with static weighting factors

respectively. In particular, we utilize the paired observation method with different error rates ( $r$ ) (i.e., 0%, 1%, 5%, 10%, 20% and 50%) so as to compare the two fusion processes.

## 5.1 Uncertainty levels of DSMT and DST

### 5.1.1 Comparison with static weighting factors

After we apply a static weights into each context attribute, the evidential fusion process based on DST has more various conflicting mass in the uncertainty level compared to the DSMT approach as shown in Figure 9(a). The reason is that the PCR5 combination rule of DSMT redistributes the total conflicting mass as equal to zero within the DSMT framework. However, Dempster's combination rule of DST takes the total conflicting mass and redistributes it to all non-empty sets within the DST framework, even those not involved in the conflict. In addition, the uncertainty level of DST is higher than that of DSMT when we use the paired observation method as shown in Figure 9(b). Thus, the DSMT approach with static weights reduces the degree of uncertainty (i.e., conflicting mass in uncertainty level) compared to the DST approach.

### 5.1.2 Comparison with different weighting factors

We apply different static weights into each context attribute based on Table 4 so as to compare the uncertainty levels of the two cases based on different weighting factors. We compare four situations: a) "*Bts*", and "*Rs*" are not activated, b) "*Ls*" and "*Bps*" are not activated, c) only "*Bts*" is not activated, and d) all sensors are activated to see the variation of the uncertainty level of contextual information. We apply 0% and 50% error rates into the fusion process with a 95% confidence interval.

As shown in Figure 10, the uncertainty levels of DSMT have the same degrees for all cases even though those of DST have different degrees depending on the four situations and the used error rates ( $r$ ) (i.e., 0% and 50%). The degrees of uncertainty of DSMT are lower than those of DST. Only when all sensors are activated will the degrees of uncertainty of DSMT be equal to those of DST. The evidential fusion based on DSMT shows a constant uncertainty level, whether a sensor reading error may happen or whether an emergency situation may progress, by redistributing the total conflicting mass only into the sets involved in the conflict and proportionally to their masses. In this case, the DSMT approach shows the better

No.	$P_s$	$L_s$	$M_s$	$B_{ps}$	$B_{ts}$	$R_s$
Case 1	0.9	0.05	0.05	0.05	0.05	0.9
Case 2	0.8	0.1	0.1	0.1	0.1	0.8
Case 3	0.7	0.1	0.2	0.1	0.2	0.7
Case 4	0.6	0.2	0.2	0.2	0.2	0.6
Case 5	0.5	0.2	0.3	0.2	0.3	0.5
Case 6	0.4	0.3	0.3	0.3	0.3	0.4
Case 7	0.3	0.4	0.3	0.3	0.4	0.3
Case 8	0.2	0.4	0.4	0.4	0.4	0.2
Case 9	0.1	0.45	0.45	0.45	0.45	0.1

Table 4. An example of different static weighting factors

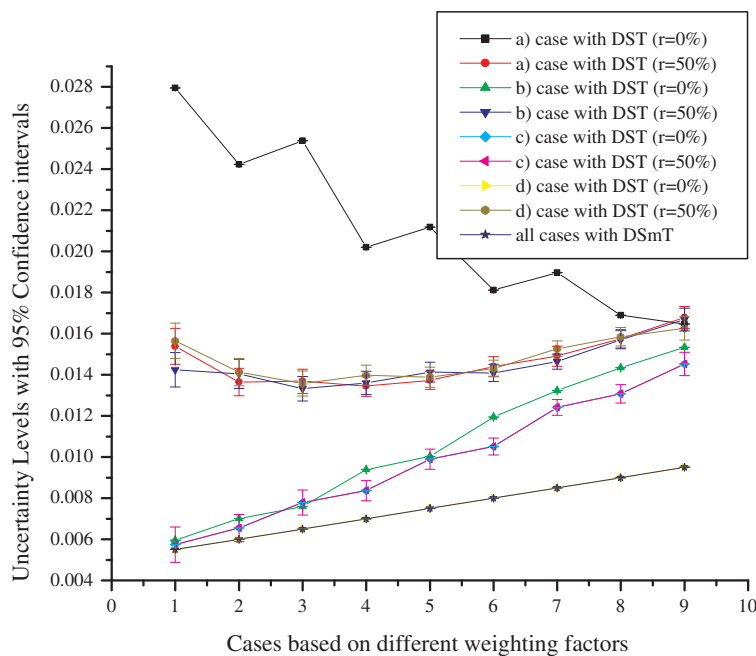

Fig. 10. Uncertainty levels of DSMT and DST with different weights

performance than the DST approach in order to reduce the conflicting mass in uncertainty level of contextual information.

### 5.1.3 Comparison with different discounting factors (D)

We apply different discounting factors ( $D$ ), which are related to sensor's credibility, into " $P_s$ " and " $R_s$ " to calculate the uncertainty levels of the two cases based on Table 5. In this case, we calculate four situations: a) " $B_{ts}$ ", and " $B_{ps}$ " are not activated, b) " $P_s$ " and " $B_{ts}$ " are not activated, c) only " $B_{ps}$ " is not activated, and d) all sensors are activated to see the variation of the uncertainty level of contextual information. Depending on different  $D$  on " $P_s$ " and " $R_s$ ", the two cases show different degrees of uncertainty as shown in Figure 11. The degrees of uncertainty of the two cases are increased based on the increase of the  $D$  as expected. The uncertainty levels of DSMT have the same degrees for all cases even though those of DST have different degrees for the four situations. The degrees of uncertainty of DSMT are lower than those of DST. This result shows that the DSMT approach is better than the DST approach in order to reduce the conflicting mass in uncertainty level of contextual information.

No.	$P_s$	$L_s$	$M_s$	$B_{ps}$	$B_{ts}$	$R_s$
Case 1	0%	20%	20%	5%	5%	0%
Case 2	1%	20%	20%	5%	5%	1%
Case 3	2%	20%	20%	5%	5%	2%
Case 4	5%	20%	20%	5%	5%	5%
Case 5	10%	20%	20%	5%	5%	10%
Case 6	20%	20%	20%	5%	5%	20%
Case 7	50%	20%	20%	5%	5%	50%

Table 5. An example of different discounting factors

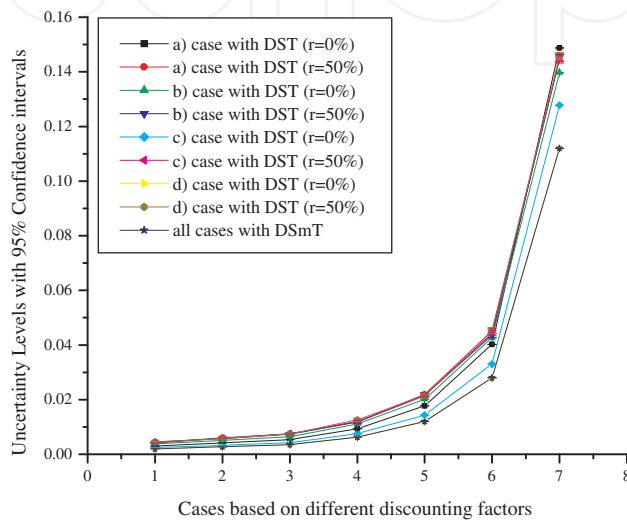

Fig. 11. Uncertainty levels of DSMT and DST with different discounting factors  $D$

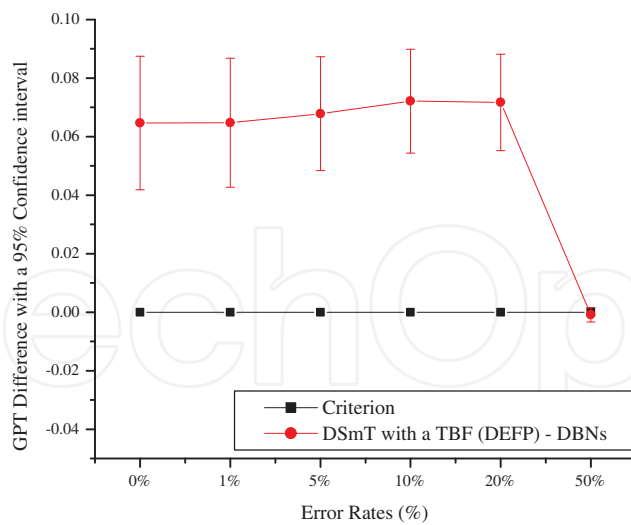

Fig. 12. Comparison GPT levels of DSMT and DBNs with static weighting factors

**5.2 GPT levels of DSMT and DBNs**

**5.2.1 Comparison with static weighting factors**

We compare the GPT level of DSMT with that of DBNs by calculating the GPT difference with a 95% confidence interval. We consider the same static weighting factors with  $T = 0$  and  $W = 5$ . We use paired observations depending on the GPT level of DSMT when the degree of

Case	$P_s$	$L_s$	$M_s$	$B_{ps}$	$B_{ts}$	$R_s$
1 (DEN)	0.9	0.05	0.05	0.05	0.05	0.9
2 (DEN)	0.5	0.25	0.25	0.2	0.2	0.6
3 (DEN)	0.3	0.4	0.3	0.3	0.3	0.4
4 (DEN)	0.1	0.4	0.5	0.4	0.4	0.2
5 (DBN)	0.9	0.05	0.05	0.05	0.05	0.9
6 (DBN)	0.5	0.25	0.25	0.2	0.2	0.6
7 (DBN)	0.3	0.4	0.3	0.3	0.3	0.4
8 (DBN)	0.1	0.4	0.5	0.4	0.4	0.2

Table 6. An example of different weights for DSMT and DBNs

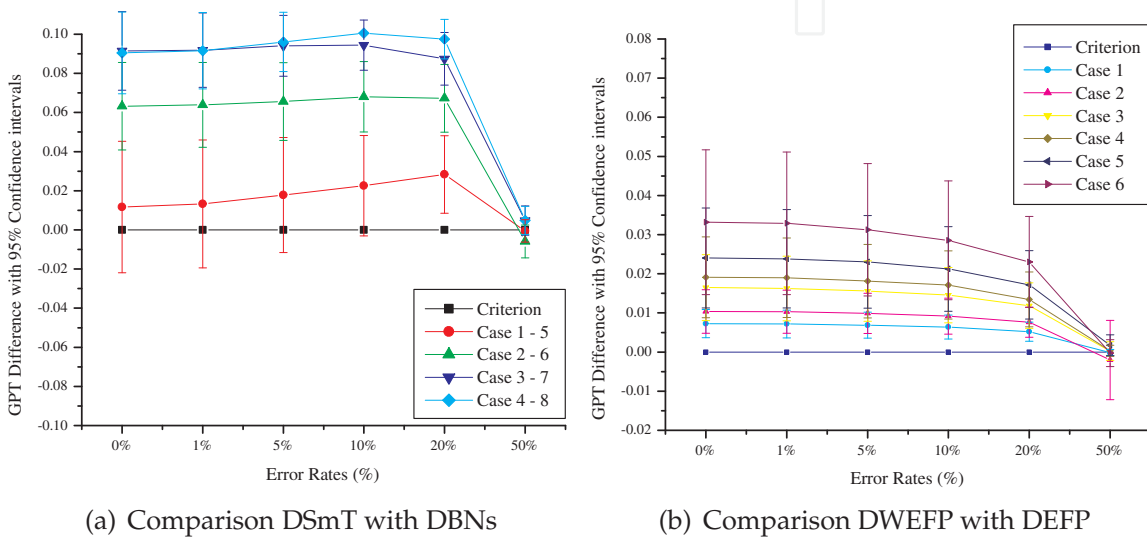

Fig. 13. Comparison GPT levels of the two cases with different weighting factors using paired observations

GPT level is over 0.5 case, because the aggregation of the degree of GPT is not over 0.5 reduces the total GPT level. The GPT level of DSMT with static weighting factor is higher than that of DBNs as shown in Figure 12. This result shows that the GPT level of the DSMT is higher than that of DBNs when the degree of GPT is over 0.5.

**5.2.2 Comparison with different weighting factors**

In order to compare the GPT level of DSMT with that of DBNs with different weighting factors, first, we apply different static weights to each context attribute based on "Ps" and "Rs" as shown in Table 6. As shown in Figure 13(a), the GPT levels of eight cases have different paired observation results. When we compare the case 1 and case 5, the confidence interval includes zero so it is impossible to distinguish which one is better than the other. The reason is that the degree of GPT is lower than 0.5 sometimes. Whereas the confidence intervals of the case 2 and 4, the case 3 and 7, and the case 4 and 8 do not have zero so we can prove that the GPT levels of DSMT with static weights are better than those of DBNs.

Second, we apply dynamic weights to each context attribute based on different % values of  $\alpha$  and  $\beta$  (i.e., from Case 1 to Case 6 in Table 3) in order to compare the GPT levels of the two cases: 1) DSMT with dynamic weights (DWEFP) and 2) DSMT with static weights (DEFP). When we utilize the paired observation method, the confidence intervals do not include zero

No.	$P_s$	$L_s$	$M_s$	$B_{ps}$	$B_{ts}$	$R_s$
Case 1 - error rate 0%	0%	0%	0%	0%	0%	0%
Case 2 - error rate 0%	5%	5%	5%	5%	5%	5%
Case 3 - error rate 5%	5%	5%	5%	5%	5%	5%
Case 4 - error rate 5%	10%	10%	10%	10%	10%	10%
Case 5 - error rate 10%	10%	10%	10%	10%	10%	10%
Case 6 - error rate 10%	20%	20%	20%	20%	20%	20%
Case 7 - error rate 20%	20%	20%	20%	20%	20%	20%
Case 8 - error rate 20%	50%	50%	50%	50%	50%	50%
Case 9 - error rate 50%	50%	50%	50%	50%	50%	50%

Table 7. Different discounting factors ( $D$ ) with selected error rates ( $r$ )

except for the error rate is 50% case as shown in Figure 13(b). With a 50% error rate, it is impossible to prove anything, because an error rate make the wrong simulation operation then it is nothing. The GPT level of DSMT with dynamic weights is higher than that of DSMT with static weights. We can improve the GPT level of DSMT using dynamic weights compared to the DEFP approach that applies static weights into each context attribute.

### 5.2.3 Comparison with different discounting factors ( $D$ )

In order to compare the GPT level of DSMT with that of DBNs with different discounting factors, first, we apply different discounting factors into each context attribute. Depending on different  $D$  on " $P_s$ " and " $R_s$ ", the two cases show different degrees of GPT levels. In addition, the GPT levels of DBNs are lower than those of the DSMT except for the 50% error rate case when we compare the two fusion processes using the paired observation method for all cases in Table 5. Based on the result of Figure 14(a), we know that the DSMT approach with different discounting factors gets the better performance than the DBNs for improving the confidence level of contextual information.

Second, we apply different discounting factors ( $D$ ) with selected error rates ( $r$ ) (i.e., 0%, 5%, 10%, 20% or 50%) into context attributes as shown in Table 7 in order to compare the GPT levels of DSMT with dynamic weights with those of DSMT with static weights. We apply updated weights into each sensor by calculating the % values of  $\alpha$  and  $\beta$  as shown in Case 1 and Case 6 of Table 3, because the % value of  $\alpha$  and  $\beta$  is the smallest and the biggest in Table 3, respectively. According to Figure 14(b), the confidence intervals do not include zero except for the error rate is 50% case. Thus, the GPT level of DSMT with dynamic weights (DWEFP) is higher than that of DSMT with static weights (DEFP) in this scenario. As a result, we can improve the degree of GPT using DSMT with dynamic weights compared to DSMT without dynamic weights.

Finally, we can infer the situation of the patient by using the mean of the  $D_F$  (i.e.,  $\bar{D}_F$ ) and pre-defined rule of a decision. For example, we assume that the pre-defined threshold ( $Te$ ) for an emergency situation is equal to 0.7. If the degree of GPT is over 0.7 for four continuous time-indexed states, we estimate that the patient is an emergency. For instance, we catch a false alarm between 10<sup>th</sup> and 12<sup>th</sup> time intervals in Figure 8. Then, we estimate that the emergency situation starts from 8<sup>th</sup> time interval. This is helpful to make a decision about the situation of a patient in home-based care.

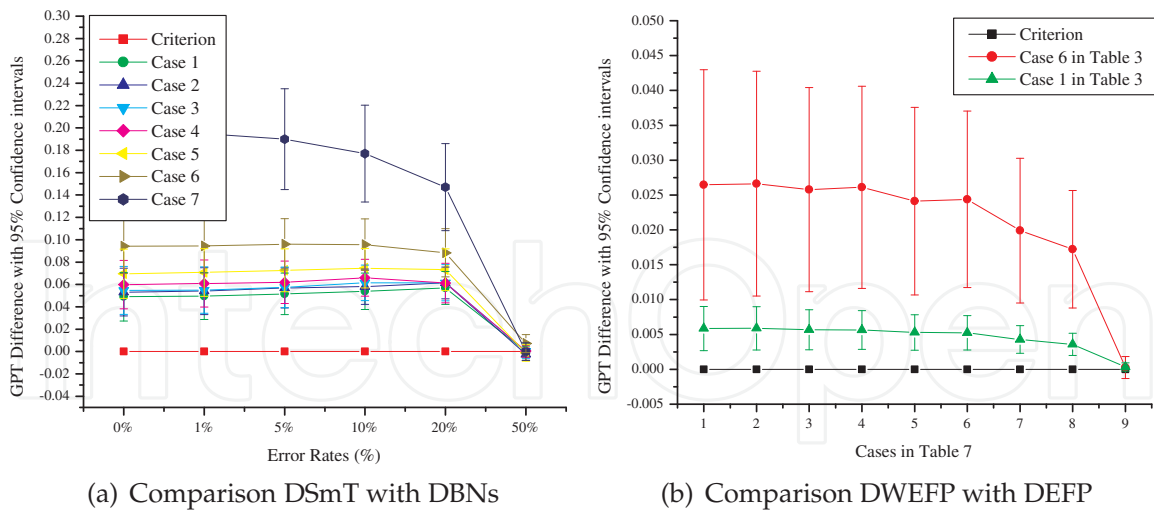

Fig. 14. Comparison GPT levels of the two cases with different discounting factors ( $D$ ) using paired observations

## 6. Related work

In context-aware applications, situations (Dey, 2001; Gellersen et al., 2002) are external semantic interpretations of low-level sensor data by permitting a higher-level specification of human behavior and the corresponding system services and the way of changing situation is called context reasoning and interpretation (Loke, 2006). It means that we need reasoning context models that can adapt the situation definitions based on discovered changes with changing environments and changing user needs (Jayaraman et al., 2009). However, both the physical world itself and our measurements of it are prone to uncertainty. Thus, different types of entities in the pervasive environment must be able to reason about uncertainty. In order to solve this problem, a number of mechanisms have been proposed in the literature for reasoning on uncertainty and there are two main purposes for reasoning on uncertainty: 1) improving the quality of contextual information and 2) inferring new kinds of contextual information. Reasoning to improve the quality of contextual information typically takes the form of multi-sensor fusion where data from different sensors are used so as to increase confidence, resolution or any other context quality metrics. Reasoning to infer new contextual information typically takes the form of deducing higher-level contexts (e.g., activity of a user) or situations from lower-level contexts (e.g., location information of a user), because we can not directly sense the higher-level contexts. These contexts may be associated with a certain level of uncertainty depending on both the accuracy of the sensed information and precision of the deduction process (Bettini et al., 2010; Lee et al., 2010a). Therefore, we introduce some context reasoning approaches such as Fuzzy logic, Probabilistic logic, Bayesian Networks (BNs), Hidden Markov Models (HMMs), Kalman Filtering Models (KFM), Dynamic Bayesian Networks (DBNs) and Dempster-Shafer Theory (DST) of the evidence in order to compare them with our context reasoning approach.

### 6.1 Fuzzy logic, probabilistic logic and BNs

In fuzzy logic, a degree of membership represented by a pair  $(A:m)$  where  $A$  is a set and  $m$  is a possibility distribution in real unit interval  $[0,1]$  is used to show an imprecise notion such as confidence values (Lemmi & Betti, 2006; Zadeh, 1999). The elements of two or more fuzzy sets can be combined in order to create a new fuzzy set with its own membership function then it

is used for reasoning models which need more than the probabilistic theory with uncertainty. For instance, the fuzzy logic is used so as to capture a clinical uncertainty in medical data of pervasive computing applications in (Agarwal et al., 2010). In addition, fuzzy logic is well suited for describing subject contexts by resolving conflicts between different contexts (e.g., Actuator's operation in (Lee et al., 2008a)). In this work, we assume that the environmental sensors are operated based on the fuzzy logic of the selected sensors.

Probabilistic logic and Bayesian networks (BNs) can be used for improving the quality of contextual information through multi-sensor fusion as well as for deriving the higher-level probabilistic contexts. They also can be used for resolving conflicts between contextual information obtained from different sources. According to (Ranganathan et al., 2004), the probabilistic logic is used for encoding access control policies and the BNs is used for combining uncertain information from a large number of sources and deducing higher-level contexts. However, these rules can not represent the ignorance (Maskell, 2008), which manages the degree of uncertainty, caused by the lack of information.

## 6.2 HMMs, KFMs and DBNs

In order to deal with unpredictable temporal changes in sensory information, Hidden Markov Models (HMMs) (Dargie, 2007; Soyer et al., 2003), Kalman Filtering Models (KFMs) (Welch & Bishop, 2006) or Dynamic Bayesian Networks (DBNs) (Dezert et al., 2004; Murphy, 2002; Zhang & Ji, 2006) are utilized as fusion techniques. In terms of probabilistic networks, HMMs represent stochastic sequences as Markov chains; the states are not directly observed, but are associated with observable evidences, and their occurrence probabilities depend on the hidden states. This model can be used for location prediction by using a hierarchical Markov model that can learn and infer a user's daily movements (Liao et al., 2007). KFMs represent the state of the system refers to a set of variables that describe the inherent properties of the system at a specific instant of time. This is a useful technique for estimating, or updating the previous estimate of, a system's state by using indirect measurements of the state variables and using the covariance information of both state variables and indirect measurements (Olfati-Saber, 2007). However, DBNs, which were proposed as a generalization of HMMs and KFMs, have some distinct features. DBNs allow much more general graph structures compared with HMMs or KFMs. DBNs represent the hidden state in terms of a set of random variable compared with HMMs, which represent the state space with a single random variable. DBNs allow general hybrid and nonlinear conditional probability densities (CPDs) compared with KFMs, which require all CPDs to be linear-Gaussian. This is a useful feature to manage the causality between random variables as well as time series data. For instance, a high level user behavior is inferred from low level sensor data by adding knowledge of real-world constraints to user location data in (Patterson et al., 2003). A variant of DBNs is used in an unsupervised way in order to predict transport routes based on GPS data. By adding constraints on the routes that could be learned by the training algorithm, the prediction accuracy was significantly improved.

DBNs are made up of the interconnected two time-indexed states of a static Bayesian Network (BN) and the transition of a static BN between two consecutive time  $t$  and  $t + 1$  satisfies the Markov property (Padhraic, 1997) as shown in Figure 15. DBNs can be implemented by keeping in memory two states at any one time-indexed state, representing a previous time-indexed state and current time-indexed state, respectively. In Figure 15, the two time-indexed states, which have an associated conditional probability, are such rotated that old states are dropped and new states are used as time progress. The arcs between two

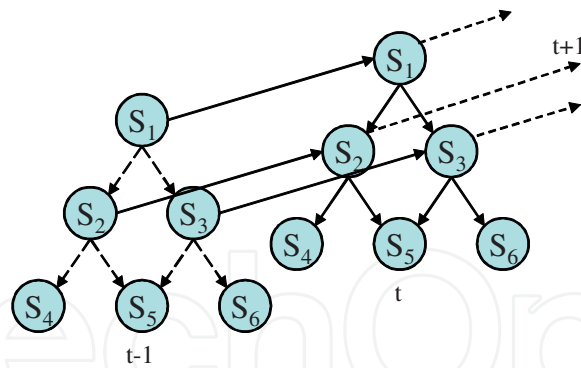

Fig. 15. An example of Dynamic Bayesian Networks (DBNs)

time-indexed states reflect temporal causality and they are parameterized by transitional probabilities. The joint distribution from the initial moment of time ( $t = 1$ ) until the time boundary ( $t = T$ ) is then given by

$$P(S_{1:T}) = \prod_{t=1}^T \prod_{i=1}^n P(S_i^t | k(S_i^t)) \quad (19)$$

where  $S_i^t$  is the  $i^{th}$  node at time  $t$  and  $k(S_i^t)$  stands for the parents of a node  $S_i^t$  at time  $t$ . They can either be in the same time-indexed state or in the previous time-indexed state. In this work, we use the Markov property, which is similar to DBNs, in order to represent temporal and state links between two consecutive time-indexed states of a Static Evidential Network (SEN) (i.e., Dynamic Evidential Network (DEN)) then compare it with the original process of DBNs.

### 6.3 Dempster-Shafer Theory (DST)

DST is a mathematical theory of the evidence based on belief and plausible reasoning, which is used to combine separate pieces of information in order to calculate the probability of the event. It is often used method of sensor fusion to deal with uncertainty associated with context reasoning by combining the independent observations of multiple sensors (e.g., the user's activity monitoring in smart home) (Hong et al., 2009; Wu et al., 2003). However, the DST has limitations and weaknesses. In particular, the Dempster's combination rule has limitations. The results of the combination has low confidences when a conflict becomes important between sources. Thus, we use the Dezert-Smarandache Theory (DSmT), which is an extended DST, as a context reasoning method. No one applies the DSmT into the ubiquitous or pervasive computing area.

## 7. Conclusion

Until now, we proposed context reasoning under uncertainty based on evidential fusion networks in home-based care in order to support both consistency verification of the model and context reasoning techniques. The proposed reasoning technique improved the quality of contextual information and inferred new kinds of contextual information.

Based on the defined pragmatic context classification, generalized context modeling, and proposed evidential fusion network (EFN), we proposed a dynamic context reasoning method. A dynamic context reasoning method deals with dynamic metrics such as preference, temporal consistency and relation-dependency of the context using the autonomous learning



process (ALP) and the temporal belief filtering (TBF). In addition, A dynamic context reasoning method improve the confidence level of contextual information using the proposed normalized weighting technique compared to previous fusion networks such as DST and DBNs.

To show the improvement of our approach, we compared the uncertainty levels of two fusion processes such as DSMT and DST and the confidence (i.e., GPT) levels of two fusion processes such as DSMT and DBNs using paired observations. Finally, we got the better performance compared to DST and DBNs.

In the future, we will continuous work on user experience in order to adapt the user's feelings stemming both from pragmatic and hedonic aspects of the system into the pervasive healthcare monitoring system (PHMS).

## 8. Acknowledgement

This work was 100% supported by the General R/D Program of the Daegu Gyeongbuk Institute of Science and Technology (DGIST).

## 9. References

- Agarwal S.; Joshi A.; Finin T.; Yesha Y.; Ganous T. (2007). A pervasive computing system for the operating room of the future, *Mobile Networks and Applications*, Vol. 12, No. 2, March, 2007, pp. 215-228, ISSN:1383-469X
- Bettini C.; Brdiczka O.; Henriksen K.; Indulska J.; Nicklas D.; Ranganathan A.; Riboni D. (2010). A survey of context modeling and reasoning techniques, *Pervasive and Mobile Computing*, Vol. 6, No. 2, April, 2010, pp. 161-180, ISSN:1574-1192
- Campos M.; Juarez J. M.; Salort J.; Palma J.; Marin R. (2009). Reasoning in dynamic systems: From raw data to temporal abstract information, *Neurocomputing*, Vol. 72, No. 4 – 6, January, 2009, pp. 871-878, ISSN:0925-2312
- Danninger M.; Stierelhagen R. (2008). A Context-Aware Virtual Secretary in a Smart Office Environment, *Proc. of the 16th ACM Intl. Conf. on Multimedia*, pp. 529-538, New York, NY, USA, 2008
- Dargie W. (2007). The Role of Probabilistic Schemes in Multisensor Context-Awareness, *Proc. of the 5th IEEE Intl. Conf. on Pervasive Computing and Communications Workshops*, pp. 27-32, Washington, DC, USA, 2007
- Dey A. K. (2001). Understandings and using context, *Personal and Ubiquitous Computing*, Vol. 5, No. 1, January, 2001, pp. 4-7, ISSN: 1617-4909
- Dezert J.; Smarandache F.; Daniel M. (2004). The Generalized Pignistic Transformation, *Proc. of the 7th Intl. Conf. on Information Fusion*, pp. 384-391, Stockholm, Sweden, 2004
- Dezert J.; Smarandache F. (2004). *Advances and Applications of DSMT for Information Fusion*, Vol. 1, American Research Press, ISBN: 1931233829, Rehoboth
- Dezert J.; Smarandache F. (2006). *Advances and Applications of DSMT for Information Fusion*, Vol. 2, American Research Press, ISBN: 1599730006, Rehoboth
- Dezert J.; Smarandache F. (2009). *Advances and Applications of DSMT for Information Fusion*, Vol. 3, American Research Press, ISBN: 1599730731, Rehoboth
- Gellersen H. W.; Schmidt A.; Beigl M. (2002). Multi-sensor context-awareness in mobile devices and smart artifacts, *Mobile Networks and Applications*, Vol. 7, No. 5, October, 2002, pp. 341-351, ISSN:1383-469X

- Hong X.; Nugent C.; Mulvenna M.; McClean S.; Scotney B.; Devlin S. (2009). Evidential fusion of sensor data for activity recognition in smart homes, *Pervasive and Mobile Computing*, Vol. 5, No. 3, June, 2009, pp. 236-252, ISSN:1574-1192
- Jain R. (1991). *The Art of Computer Systems Performance Analysis Techniques for Experimental Design, Measurement, Simulation, and Modeling*, John Wiley & Sons, Inc., ISBN: 0471503363, Digital Equipment Corporation, Littleton, Massachusetts
- Jayaraman P. P.; Zaslavsky A.; Delsing J. (2009). Dynamic Situation Modeling and Reasoning under Uncertainty, *Proc. of the Intl. Conf. on Pervasive Services*, pp. 113-122, London, UK, 2009
- Lee H.; Choi J.; Elmasri R. (2008a). A conflict resolution architecture for the comfort of occupants in intelligent office, *Proc. of the 4th IET Intl. Conf. on Intelligent Environments*, pp. 1-8, University of Washington, Seattle, USA, 2008
- Lee H.; Choi J.; Elmasri R. (2009). Sensor Data Fusion using DS<sub>m</sub> Theory for Activity Recognition under Uncertainty in Home-based Care, *Proc. of the 23th IEEE Intl. Conf. on Advanced Information Networking and Applications*, pp. 517-524, Bradford, UK, 2009
- Lee H.; Lee B.; Park K.; Elmasri R. (2010). Fusion Techniques for Reliable Information: A Survey, *International Journal of Digital Content Technology and its Applications*, Vol. 4, No. 2, June, 2010, pp. 74-88, doi: 10.4156/jdcta
- Lee H.; Park K.; Lee B.; Choi J.; Elmasri R. (2008). Issues in data fusion for healthcare monitoring, *Proc. of the 1st ACM Intl. Conf. on Pervasive Technologies Related to Assistive Environments*, pp. 1-8, Athens, Greece, 2008
- Lemmi A.; Betti G. (2006). Capability approach and fuzzy set theory: description, aggregation and inference issues, *Fuzzy set approach to multidimensional property measurement*, Vol. 3, No. 1, pp. 93-113
- Liao L.; Patterson D. J.; Fox D.; Kautz H. (2007). Learning and inferring transportation routines, *Artificial Intelligence*, Vol. 171, No. 5 – 6, April, 2007, pp. 311-331, ISSN:0004-3702
- Loke S. (2006). On representing situations for context-aware pervasive computing: Six ways to tell if you are in a meeting, *Proc. of the 4th IEEE Intl. Workshop on Pervasive Computing and Communications*, pp. 35-39, Pisa, Italy, 2006
- Maskell S. (2008). A Bayesian approach to fusing uncertain, imprecise and conflicting information, *Information Fusion*, Vol. 9, No. 2, April, 2004, pp. 259-277, ISSN:1566-2535
- Murphy K. (2002). *Dynamic Bayesian Networks: Representation, Inference and Learning*, Ph. D. Dissertation, Univ. of California, Berkeley, 2002
- Olfati-Saber R. (2007). Distributed Kalman Filtering for Sensor Networks, *Proc. of the 46th IEEE Intl. Conf. on Decision and Control*, pp. 5492-5498, New Orleans, Louisiana, USA, 2007
- Padhraic S. (1997). Belief Networks, Hidden Markov Model, and Markov Random Field: A Unifying View, *Pattern Recognition letters*, Vol. 18, No. 11 – 13, November, 1997, pp. 1261-1268, ISSN:0167-8655
- Padovitz A.; Loke S. W.; Zaslavsky A.; Bartolini C. (2005). An approach to data fusion for context awareness, *Proc. of the 5th Intl. Conf. on Modeling and Using Context*, pp. 353-367, Paris, France, 2005
- Patterson D. J.; Liao L.; Fox D.; Kautz H. (2003). Inferring high-level behavior from low level sensors, *Proc. of the 5th Intl. Conf. on Ubiquitous Computing*, pp. 73-89, Seattle, Washington, USA, 2003

- Ramasso E.; Rombaut M.; Pellerin D. (2006). A Temporal Belief Filter Improving Human Action Recognition in Videos, *Proc. of the IEEE Intl. Conf. on Acoustics, Speech, and Signal Processing*, pp. 141-144, Toulouse, France, 2006
- Ranganathan A.; Al-Muhtadi J.; Campbell R. H. (2004). Reasoning about uncertain contexts in pervasive computing environments, *IEEE Pervasive Computing*, Vol. 3, No. 2, April, 2004, pp. 62-70, ISSN:1536-1268
- Razzaque M. A.; Dobson S.; Nixon P. (2007). Classification and Modeling of the quality of Contextual Information, *IEEE TCAAS Letters*, 2007
- Rogova G. L.; Nimier V. (2004). Reliability in information fusion: literature survey, *Proc. of the 7th Intl. Conf. on Information fusion*, pp. 1158-1165, Stockholm, Sweden, 2004
- Roy N.; Roy A.; Das S.; Basu K. (2005). A cooperative learning framework for mobility-aware resource management in multi-inhabitant smart homes, *Proc. of the 2nd IEEE Intl. Conf. on Mobile and Ubiquitous Systems: Networking and Services*, pp. 393-403, San Diego, CA, USA, 2005
- Shafer G. (1976). *A Mathematical Theory of Evidence*, Princeton Univ. Press, ISBN: 0691081751, Princeton, New Jersey
- Smarandache F.; Dezert J. (2005). Information fusion based on new Proportional Conflict Redistribution rules, *Proc. of the 8th Intl. Conf. on Information Fusion*, pp. 907-914, Philadelphia, PA, USA, 2005
- Smets P. (2000). Data Fusion in the transferable Belief Model, *Proc. of the 3rd Intl. Conf. on Information Fusion*, pp. 21-33, Paris, France, 2000
- Soyer C.; Bozma H. I.; Isterfanopulos Y. (2003). Attentional Sequence-based Recognition: Markovian and Evidential Reasoning, *IEEE Transactions on Systems, Mans, and Cybernetics, Part B: Cybernetics*, Vol. 33, No. 6, November, 2003, pp. 937-950, ISSN:1083-4419
- Valiris G.; Chytas P.; Glykas M. (2005). Making decisions using the balanced scorecard and the simple multi-attribute rating technique, *Performance Measurement and Metrics*, Vol. 6, No. 3, pp. 159-171, ISSN: 1467-8047
- Welch G.; Bishop G. (2006). *An Introduction to the Kalman Filter*, UNC-Chapel Hill, TR 95-041, Chapel Hill, NC, USA
- Winterfeld D.; Edwards W. (1986). *Decision Analysis and Behavioral Research*, Cambridge, ISBN: 0521273048, University Press, Cambridge, UK
- Wu H.; Siegel M.; Ablay S. (2003). Sensor fusion using dempster-shafer theory II: static weighting and kalman filter-like dynamic weighting, *Proc. of the 20th IEEE Instrumentation and Measurement Technology Conference*, pp. 907-912, Vail, CO, USA, 2003
- Zadeh L. A. (1999). Fuzzy sets as a basis for a theory of possibility, *Fuzzy Sets and Systems*, Vol. 100, No. 1, April, 1999, pp. 9-34, ISSN:0165-0114
- Zhang Y.; Ji Q. (2006). Active and Dynamic Information Fusion for Multisensor Systems with Dynamic Bayesian Networks, *IEEE Transactions on Systems, Mans, and Cybernetics, Part B: Cybernetics*, Vol. 36, No. 2, March, 2006, pp. 467-472, ISSN:1083-4419

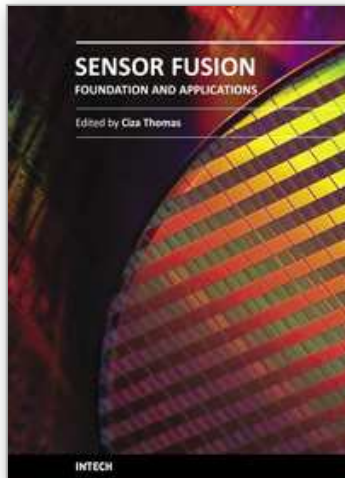

## **Sensor Fusion - Foundation and Applications**

Edited by Dr. Ciza Thomas

ISBN 978-953-307-446-7

Hard cover, 226 pages

**Publisher** InTech

**Published online** 24, June, 2011

**Published in print edition** June, 2011

Sensor Fusion - Foundation and Applications comprehensively covers the foundation and applications of sensor fusion. This book provides some novel ideas, theories, and solutions related to the research areas in the field of sensor fusion. The book explores some of the latest practices and research works in the area of sensor fusion. The book contains chapters with different methods of sensor fusion for different engineering as well as non-engineering applications. Advanced applications of sensor fusion in the areas of mobile robots, automatic vehicles, airborne threats, agriculture, medical field and intrusion detection are covered in this book. Sufficient evidences and analyses have been provided in the chapter to show the effectiveness of sensor fusion in various applications. This book would serve as an invaluable reference for professionals involved in various applications of sensor fusion.

### **How to reference**

In order to correctly reference this scholarly work, feel free to copy and paste the following:

Hyun Lee, Jae Sung Choi and Ramez Elmasri (2011). A Dynamic Context Reasoning based on Evidential Fusion Networks in Home-Based Care, Sensor Fusion - Foundation and Applications, Dr. Ciza Thomas (Ed.), ISBN: 978-953-307-446-7, InTech, Available from: <http://www.intechopen.com/books/sensor-fusion-foundation-and-applications/a-dynamic-context-reasoning-based-on-evidential-fusion-networks-in-home-based-care>

**INTECH**  
open science | open minds

### **InTech Europe**

University Campus STeP Ri  
Slavka Krautzeka 83/A  
51000 Rijeka, Croatia  
Phone: +385 (51) 770 447  
Fax: +385 (51) 686 166  
[www.intechopen.com](http://www.intechopen.com)

### **InTech China**

Unit 405, Office Block, Hotel Equatorial Shanghai  
No.65, Yan An Road (West), Shanghai, 200040, China  
中国上海市延安西路65号上海国际贵都大饭店办公楼405单元  
Phone: +86-21-62489820  
Fax: +86-21-62489821

© 2011 The Author(s). Licensee IntechOpen. This chapter is distributed under the terms of the [Creative Commons Attribution-NonCommercial-ShareAlike-3.0 License](https://creativecommons.org/licenses/by-nc-sa/3.0/), which permits use, distribution and reproduction for non-commercial purposes, provided the original is properly cited and derivative works building on this content are distributed under the same license.

IntechOpen

IntechOpen