

We are IntechOpen, the world's leading publisher of Open Access books Built by scientists, for scientists

4,800

Open access books available

122,000

International authors and editors

135M

Downloads

Our authors are among the

154

Countries delivered to

TOP 1%

most cited scientists

12.2%

Contributors from top 500 universities

**WEB OF SCIENCE™**Selection of our books indexed in the Book Citation Index
in Web of Science™ Core Collection (BKCI)

Interested in publishing with us? Contact book.department@intechopen.com

Numbers displayed above are based on latest data collected.

For more information visit www.intechopen.com

Evolutionary Optimization of Microwave Filters

Maria J. P. Dantas¹, Adson S. Rocha³, Ciro Macedo², Leonardo da C. Brito²,
Paulo C. M. Machado² and Paulo H. P. de Carvalho³

¹*Catholic University of Goiás, Goiânia, GO,*

²*Federal University of Goiás, Goiânia, GO,*

³*University of Brasília, Brasília, DF
Brazil*

1. Introduction

The optimization of circuits with the aim of improving performance, lowering costs, and more recently, to reduce the size and weight of electronic devices, among other objectives, has become a research field in the areas of mathematics and engineering around the world (Antoniou & Lu, 2007). The problem can be interpreted as: among all possible models for the circuit, considering topology and values of components, find a model with minimum size and appropriate parameters, able to meet a set of typically conflicting hard specifications.

The deterministic methods are not effective in the design of new circuits, since it does not always have available accurate mathematical models of the processes to be optimized (Levy et al., 2001). However, a number of new stochastic algorithms have allowed the development of nearly optimal circuits, which are quite acceptable from the standpoint of their implementations. The techniques currently used require much prior knowledge about the circuit to be optimized and this knowledge is not always available. The challenge, then, is the development of robust techniques that rely less in specialist knowledge or even incorporating this knowledge, and show efficiency equal or superior to the traditional methods.

In general, due to the complexity of the problems associated with different types of circuit designs, sub-optimal solutions are looked for in order to mitigate the mathematical complexity of the analytical models, generating approximate solutions, but with acceptable results (Levy et al., 2001). Evolutionary methods, so called because they use principles of evolution found in nature, are natural candidates to this task, since they are able to find optimal solutions or solutions near the optimum, using mechanisms of selection, crossover and mutation (Holland, 1970). Most methods in the literature consider an initial topology for the circuit and only optimize its parameters, such as, for example, in (Hsu & Huang, 2005). However, it is desirable that the topological structure also goes under optimization, allowing, among other things, the search for new topologies, which is a requirement of current applications. Other methods, using the traditional Genetic Programming as in the work of Koza (Koza et al., 1996), optimize the topology, without considering any prior knowledge, but demand a high computational cost and also have some methodological drawbacks such as premature convergence and stagnation, among others (Hu & Rosemberg, 2004).

This chapter discusses the application of evolutionary methods to design RF/microwave filters, making comparisons with traditional methods and other evolutionary methodologies proposed in the literature for the same class of problems. The design of analog circuits will be addressed as a problem of simultaneous optimization of topology and parameters, and we will present a general evolutionary method for synthesis of analog circuits, whose application produces competitive solutions when compared with other methods already proposed in the literature.

2. Description of the method

Fig. 1 shows the flowchart of the Memetic Evolutionary Algorithm. This hybrid (memetic) method associates a local search technique widely explored in the literature, the Simulated Annealing algorithm (Michalewicz & Fogel, 2004), to the global search Evolutionary Algorithm. In the following sections, the features of the method will be described.

2.1 Two-port circuit representation

Two-port circuit representation is widely used to describe microwave circuits, from passive to active elements, such as transistors. So, it becomes necessary to represent the evolvable circuit shown in Fig. 2 by two-port sub-circuits. Thus, the circuit is encoded into the hereinafter called Positional Matrix.

The initial size of this evolvable matrix is given by the number of elements of the initial circuit, which is composed by a set of elements cascaded from the source towards the load. The build-up process of the initial Positional Matrix is as follows:

1. Randomly define the size n of the Positional Matrix;
2. Randomly select n circuit elements from a database and assemble the initial Positional Matrix by cascading them into its main diagonal, from the source to the load;
3. Repeat m times

Randomly select a row i and a column j of the Positional Matrix, subject to $i \leq j$. Randomly select a circuit building-block and its respective connection type based on constraining rules and encode it in the position (i, j) of the Positional Matrix (e.g., as depicted in Fig. 4).

Along the evolution process, other building blocks are placed into or removed from the variable-size Positional Matrix, as described in the following sections. This specific feature of this approach gives degrees of freedom to the process of suitable topology discovery. The possible types of connection are: cascade, serial, parallel, or hybrid. Besides the building-blocks, topology constraining rules also feeds the algorithm, as depicted by the database in Fig. 3.

Figs. 4 and 5 illustrate the proposed representation. In the Positional Matrix of Fig. 4, the circuit elements (building-blocks) $b_{11}^{(1)}$, $b_{22}^{(1)}$, and $b_{33}^{(1)}$ are connected in cascade; $b_{11}^{(2)}$ and $b_{11}^{(1)}$, are connected in parallel (p); $b_{13}^{(1)}$ is in series (s) with the input port of $b_{11}^{(1)}$ and in parallel (p) with the output port of $b_{33}^{(1)}$ (hybrid connection); $b_{23}^{(1)}$ is in parallel (p) with the input port of $b_{22}^{(1)}$ and in series with the output port of $b_{33}^{(1)}$; (hybrid connection). Fig. 5 shows its respective topological representation.

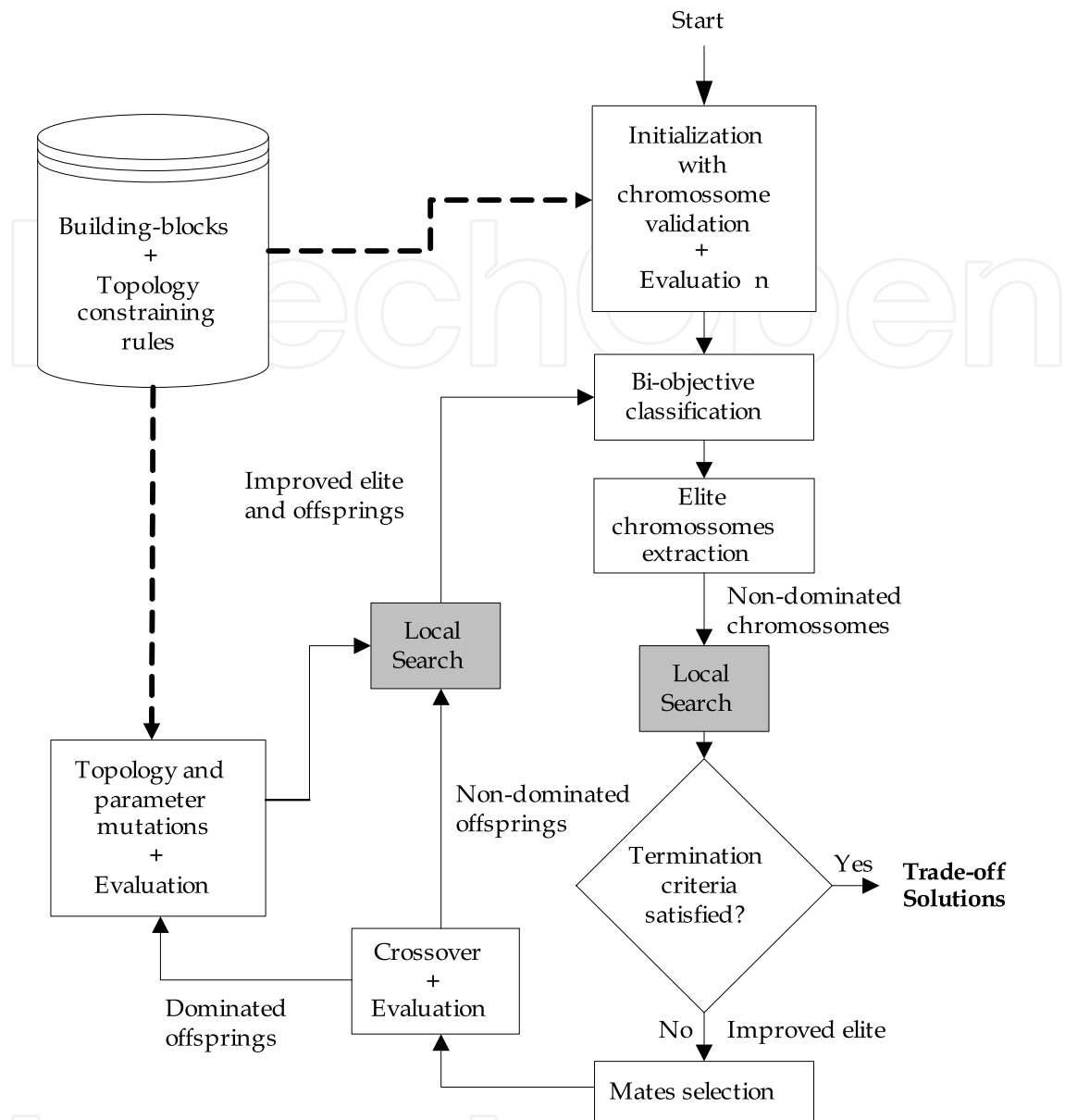

Fig. 1. The Bi-objective Memetic Evolutionary Algorithm.

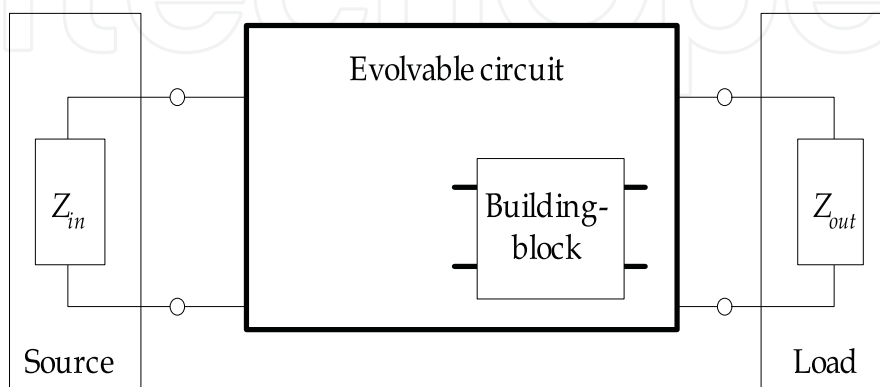

Fig. 2. Template of the evolvable circuit.

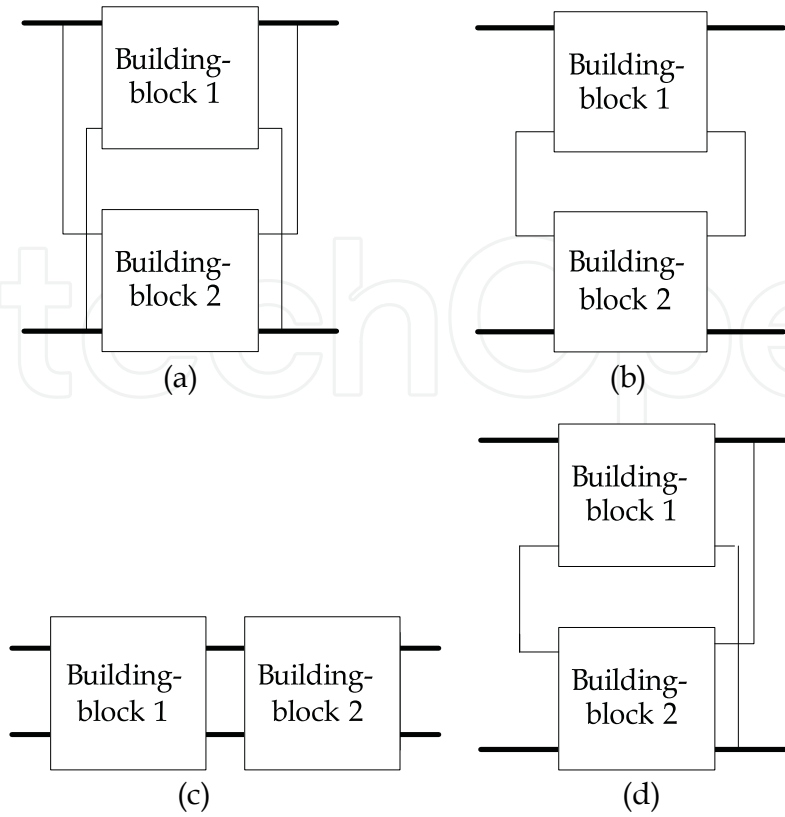

Fig. 3. The possible connections types between two-port building blocks: (a) parallel, (b) serial, (c) cascade, and (d) hybrid (serial connection in the input port and parallel in the output port).

Source	(1,1)	(1,2)	(1,3)	Load
	$b_{11}^{(2)} = \begin{bmatrix} 1 & 3 \\ 2 & 4 \end{bmatrix}$ (p) $b_{11}^{(1)} = \begin{bmatrix} 1 & 3 \\ 2 & 4 \end{bmatrix}$ (c)		$b_{13}^{(1)} = \begin{bmatrix} 2 & 7 \\ 10 & 8 \end{bmatrix}$ (h) - s/p	
	(2,1)	(2,2)	(2,3)	
$\begin{bmatrix} 1 \\ 10 \end{bmatrix}$		$b_{22}^{(1)} = \begin{bmatrix} 3 & 5 \\ 4 & 6 \end{bmatrix}$ (c)	$b_{23}^{(1)} = \begin{bmatrix} 3 & 8 \\ 4 & 9 \end{bmatrix}$ (h) - p/s	
	(3,1)	(3,2)	(3,3)	
			$b_{33}^{(1)} = \begin{bmatrix} 5 & 7 \\ 6 & 8 \end{bmatrix}$ (c)	$\begin{bmatrix} 7 \\ 9 \end{bmatrix}$

Fig. 4. Example of Positional Matrix (size 3×3).

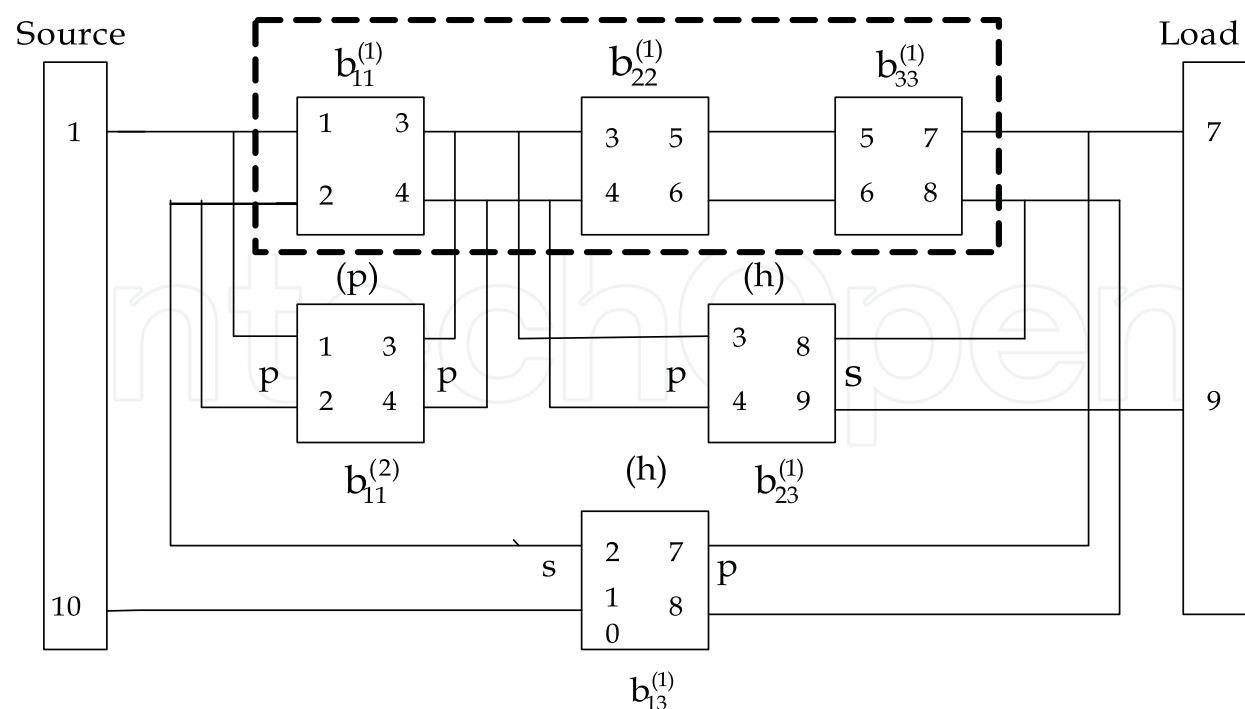

Fig. 5. Topological representation.

Note that the matrix is handled directly by the algorithm without the need of a one-dimensional equivalent representation. In (Mesquita et al., 2002) a matrix representation for circuit synthesis is proposed but the mapping bi to one-dimensional is performed before the crossover operator is applied. However, in (Im et al., 2003), it is shown that this procedure loses neighbor structures, which is fundamental for the good behavior of the evolution process. In the representation presented in this chapter, the Positional Matrix is always associated with valid circuits, what does not occur in other methods, with always present the generation of anomalous circuits in each generation. In the representation proposed by (Mesquita et al., 2002) the percentage of anomalous circuits is about 5% , but the author says that this percentage can reach 80%, which is undesirable.

2.2 Database entries

The presented algorithm uses an approach with combinations of building-block and topology constraining rules, as used in (Dastidar et. al, 2005, Lai & Jeng, 2006). This allows the use of expert knowledge to reduce the search space, avoiding anomalous circuits and producing structured circuits. The building-blocks are structures known in the literature or can be defined by the user. The rules allow topological constraints. For example, the user may allow only the occurrence of inline topologies. He may set the maximum number of connections between the circuit blocks (between source and load or between other circuit elements), the types of integration (serial, parallel, cascade, mixed), and the types of connections between blocks of circuits (direct, cross), among others. These constraints are used to compose the initial population and to accept or reject a new circuit composed during the evolution process. This feature significantly improves the quality of initial population, which represents an early memory stage. This adds expert knowledge, which somehow also contributes for reducing the search space, and still avoiding anomalous circuits at this stage. Fig. 6 illustrates the process.

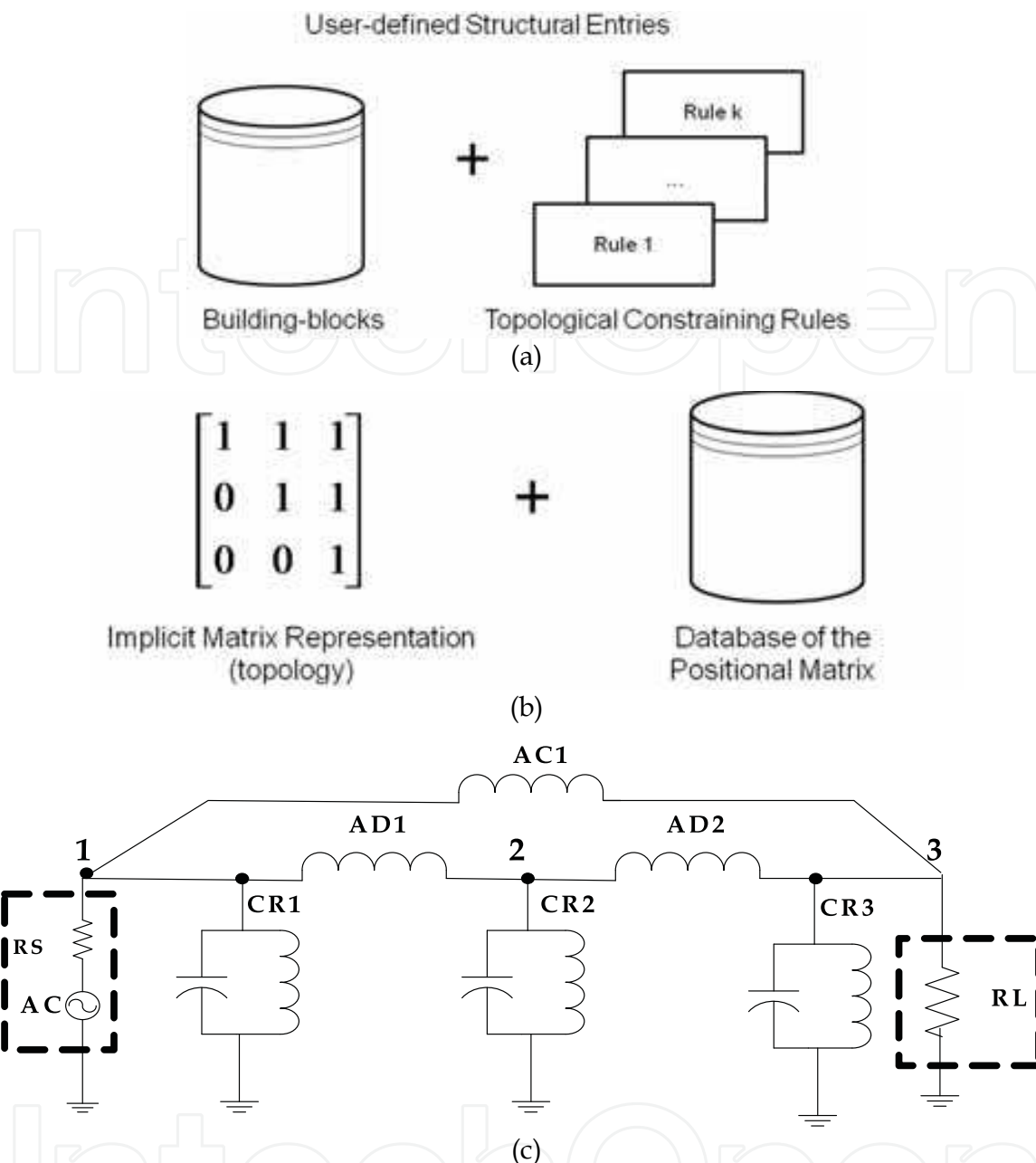

Fig. 6. Structural entries: (a) specialist database, (b) representation of the solution, and (c) a circuit composed from the structural entries.

2.3 Population initialization

The population is initialized with circuits composed by building-blocks, randomly selected from the database previously mentioned. They are connected according to the Positional Matrix previously completed, using the rules of topological constraints. Initially, only a building-block is connected to a possible pair of nodes. At the same time a building-block is selected, values are assigned to its parameters. This selection is random and held in a range of values predetermined by the user. The rules of structural constraints can be set by the user, if he has expert knowledge. Once defined, the types of connections allowed between the circuit elements are established: connections in series, parallel, cascade, mixed, number of paths between source and load, n

number of paths between parts of the circuit, if the source and the load will be directly coupled, what types of coupling that are allowed, etc. The definition of coupling rules can improve the quality of the initial population. In case the user does not have this knowledge, the algorithm performs a default initialization. It generates a matrix associated with a valid circuit of arbitrary size - for this, all entries are filled with high probability. Soon after, the algorithm checks whether the generated matrix corresponds to a connected circuit and, if it is wrong, a repairing procedure is performed.

2.4 Evaluation functions

In this method, two objective-functions are defined in order to allow a trade-off relation: (a) the circuit performance, which is evaluated using a frequency-domain circuit simulation method; and (b) the circuit size, given by the number of two-port building-blocks. The circuit simulator computes the frequency responses (the scattering parameters) over a set of frequencies uniformly distributed in the range defined by the user. Then, the algorithm calculates the sum of the squared deviations between the computed aggregate responses and the desired responses (sum squared error), as in (1). The desired response is provided as scattering parameters masks for the absolute values of the transmission coefficient $|S_{21}|$ and reflection coefficient $|S_{11}|$, given in dB.

$$SSE = \sum_{j=1}^k \left[\left(|S_{21}(f_j)| - |S_{21}^*(f_j)| \right)^2 + \left(|S_{11}(f_j)| - |S_{11}^*(f_j)| \right)^2 \right] \quad (1)$$

In (1), k is the number of evaluation frequencies, $|S_{21}^*(f_j)|$ is the constraining value of the response mask of the respective scattering parameter at f_j . The difference $|S_{21}(f_j)| - |S_{21}^*(f_j)|$ in (1) is set to zero if the mask is not violated by the value $|S_{21}(f_j)|$. The same criterion is applied to $|S_{11}|$.

2.5 Evolution schemes

The population is randomly initialized with circuits (individuals or chromosomes) that use the template circuit shown in Fig. 2, which is composed by two-port circuit elements (genes) randomly selected from the previously defined database. In order to generate high-performance small circuits, a bi-objective selection approach - the crowded-comparison operator, extracted from the NSGA-II (Deb et al., 2002) - is applied in this method at two points: to extract the elite (non-dominated chromosomes) of the current population, as well as the elite of the offspring. The two evaluation functions (objective-functions) previously defined are taken into account. The elite individuals of the population, i.e. the Pareto front, are found by applying this classification method. The selection scheme used here is the well-known binary tournament method (Michalewicz & Fogel, 2004).

The proposed approach provides the balance between performance and size of the solutions, and, consequently, makes it possible to naturally reduce the tendency of the process for producing larger circuits as the population evolves. Additionally, it allows the extraction of new building-blocks (as desired concerning the building-block hypothesis (Goldberg, 1989)) derived by the evolution process. They can be used in the next stage to produce the competitive circuits with some degree of structural redundancy.

A local search process assists the Evolutionary Algorithm for fitness improvement of candidate circuits, refining their parameters in order to avoid good topologies with non-

optimized parameter values to be prematurely discarded. The evaluation criterion to accept new parameters for a given topology is mono-objective, based on the performance function (1). This process takes place in two points of the evolution cycle. After the classification process, the local search method is applied to each elite individual. Also, the local search procedure is carried out after the crossover/mutation procedure. Doing so, the topology space is explored and, subsequently, the parameters of the new topologies are improved. As a result, offspring solutions will be able to fairly compete with the current elite set for composing the elite of the next generation. The Simulated Annealing technique (Michalewicz & Fogel, 2004) with few iterations and predefined temperature values was adopted. Only a low computational effort is necessary for each local search (circuit parameters tuning).

2.6 Bidimensional topology crossover operator

Only one crossover operator is proposed. Fig. 7 sketches this operator. Each crossover operation generates only one offspring. The crossover occurs as follows.

1. Given two reduced matrices, a cut point in parent matrix 1 is randomly chosen, such that four regions are defined, as shown in Fig 7(a).
2. After that, a square sub-matrix in parent matrix 2 is arbitrarily defined, as shown in Fig. 7(b) and Fig. 7(c). Fig. 7(e) e Fig. 7(f) illustrates the offspring composition. The blocks R_1 , R_2 , R_3 and R_4 in the offspring matrix are from the parent matrix 1, the block R_5 is from the parent matrix 2, and the block R_6 , is randomly selected from the corresponding block in parent matrix 1 or from 2. Two types of offspring composition are possible and likely to occur: cut-splice, as in Fig. 7(c); cut-overlap, as in Fig. 7(d).

Then, the proposed crossover operator can explore the knowledge content of the body of the parents, and can also promote the diversity of structures. Since selection of the cut point is independent for each Parent Matrix, it is obvious that the length of the produced offspring matrix can vary during the evolution process. Then, circuits with different sizes and complexities evolve together by exchanging their genetic material.

2.7 Bidimensional topology and value mutation operators

Four types of likely topology mutation were defined. The circuit mutation is performed via one of the following operations:

1. adding a randomly selected building-block, without position restriction in the Positional Matrix;
2. deleting a randomly selected building-block, given that the circuit remains connected;
3. deleting a randomly selected building-block from the diagonal matrix, by removing a row/column, given that the circuit remains connected;
4. inserting an arbitrary building-block in cascade into the diagonal of the Positional Matrix, by adding a row/column.

All the parameters of the two-port circuit elements of the circuit may undergo mutation. When a parameter is mutated, a new parameter value is randomly generated through a uniform distribution bounded by the predefined range of possible values.

3. Experiment and results

Several different two-port filters were synthesized, presenting several complexity levels. The proposed method successfully produced filters that complied with the rigorous specifications. The number of circuit evaluations for the entire synthesis process was not

large. A simple bandpass and a type of dual band-pass filter, which offers a considerable difficulty degree, illustrate the application of the proposed method in this section. In recent years, dual-band filters have become extremely important components for wireless communication devices at microwave frequencies (Chen & Hsu, 2006, Hu et al., 2004, Koza et al., 1996, Grimbleby, 2000, Zebulum et al., 1998, Nishino & Itoh, 2002, Lai & Jeng, 2006). Its design is a hard problem, as reported in previous works (see (Lai & Jeng, 2006, Tsai & Hsue, 2004, Zhang, 2007), for example).

The crossover probability was set to 100%, the topology mutation probability was set to 20%, and the parameters mutation probability was set to 5%. The circuit performance was analyzed at 80 discrete frequencies. In all 10 runs, the proposed algorithm achieved results that accomplished the specifications.

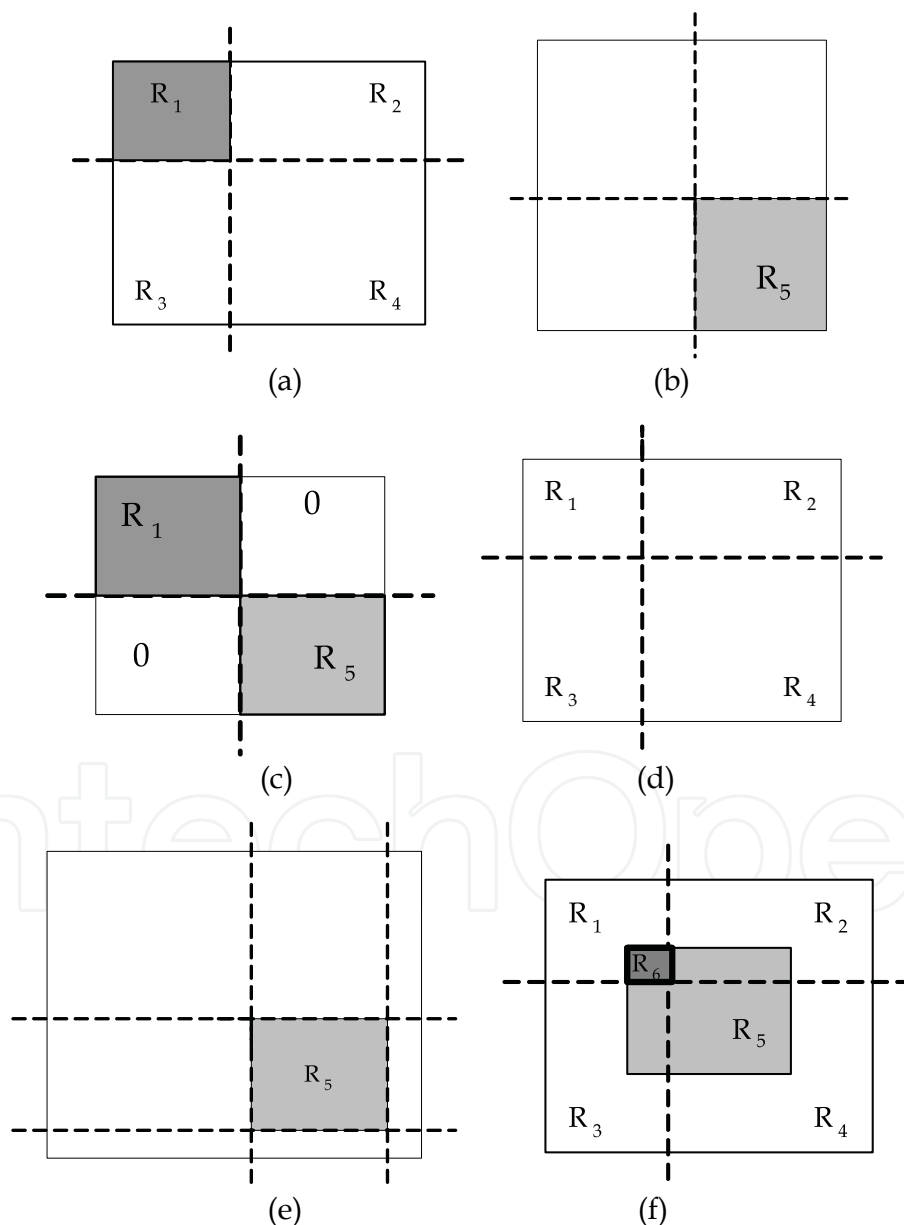

Fig. 7. Crossover operator: (a) parent matrix 1, (b) parent matrix 2, (c) cut-splice operation, (d) parent matrix 1, (e) parent matrix 2, and (f) cut-overlap operation.

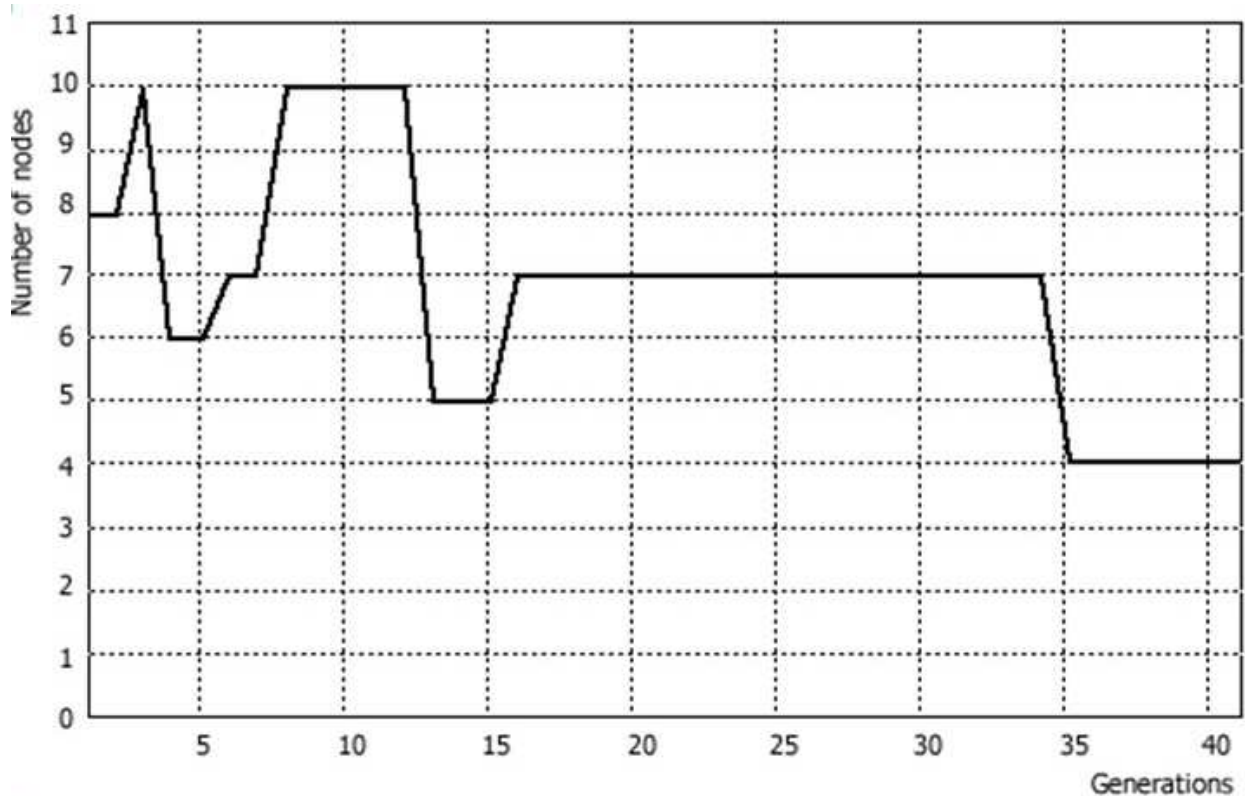

Fig. 8. Evolution of number of nodes (size of the circuit) of the best solution.

3.1 Narrowband filter

A simple bandpass filter was generated in this experiment. The best solution has a circuit with 4 nodes and 12 components. The solution was obtained after 41 generations with populations of 30 circuits, i.e. with 16,000 circuit evaluations. It can be observed in Fig. 8 that the size of the circuit varies during the evolution process, which means that changes occur until the process reaches a structure that meets the specifications. One can also notice that the proposed method achieves a solution topology, as shown in Fig. 9, where building-blocks naturally appear due to the evolution process, e.g. the sub-circuit composed by an inductor and a capacitor in parallel that appears regularly on the circuit. The frequency response of the circuit is shown in Fig. 10. Koza (Koza et al., 1996), using Genetic Programming with populations of 640,000 individuals and 199 generations (127,360,000 circuit evaluations) achieved a circuit with 38 components. Grimbly (Grimbleby, 2000),

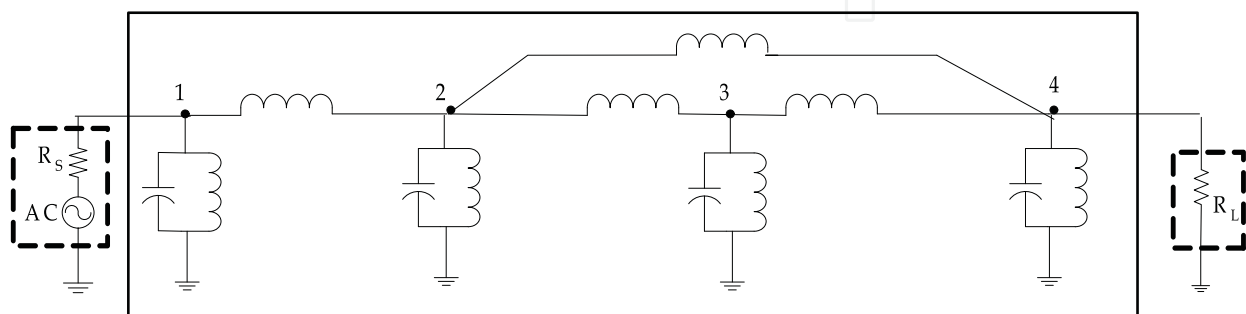

Fig. 9. Best topology obtained.

using a hybrid Genetic Algorithm, obtained a circuit with 4 nodes, but did not mention the computational effort required to reach such a solution. Shin (Shin & Histoshi, 2003), using a multi-stage Genetic Algorithm obtained a solution with a population of 2,000 individuals after 400 generations, which represents 800,000 circuit evaluations. The authors did not present the obtained circuit structure.

3.2 Dual-band filter

In this experiment, a filter for dual-band systems was synthesized. The same filter was synthesized in (Lai & Jeng, 2006); (Tsai & Hsue, 2004) with the following specifications: the return losses (reflection coefficient inside the pass-bands) within 3.4–3.6 and 5.4–5.6 GHz > 10 dB, and the rejections (transmission coefficient outside the pass-bands) within 2.0–3.0, 4.0–5.0, and 6.0–7.0GHz > 20 dB.

Table 1 and Fig. 11 present the building-blocks and connection types. Besides that, during the evolution process, as a topology constraining rule, only common junctions in microstrip circuits were allowed (step-, tee-, and cross junctions) (Tsai & Hsue, 2004).

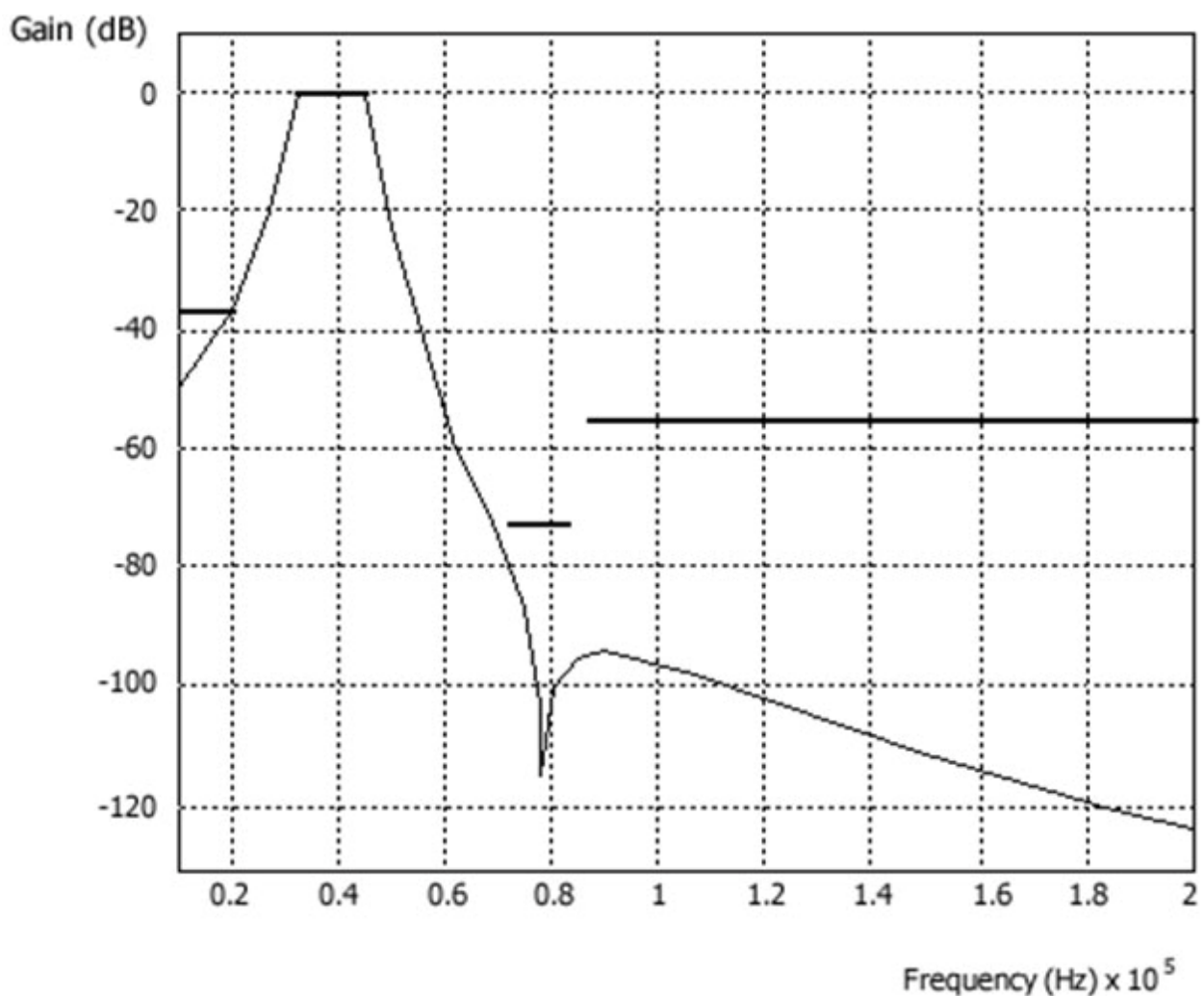

Fig. 10. Frequency response of the best solution.

Two-port circuit building blocks	Connection types	Physical parameters	Electrical parameters (lower and upper bounds)	
			Z_{01} , as a function of L (length)	Θ_1 (at 4 GHz), as a function of W (width)
TL	Cascade or Parallel	L, W	40 - 110	30 - 100
Sh-TL-OC	Cascade	L, W	40 - 110	20 - 160
Sh-TL-SC	Cascade	L, W	40 - 110	20 - 160
Sh-TL2-OC	Cascade	L_1, W_1, L_2, W_2	40 - 110	20 - 120
Sh-TL2-SC	Cascade	L_1, W_1, L_2, W_2	40 - 110	20 - 120

Table 1. Building-blocks and connection types.

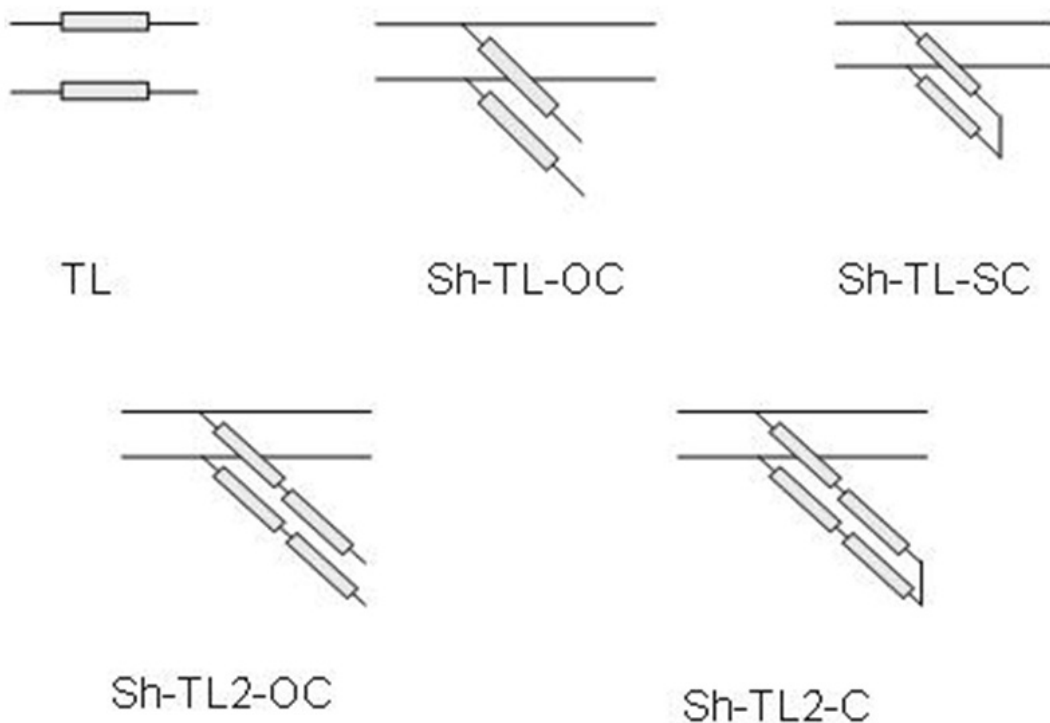

Fig. 11. Building-blocks of the experiment.

The best topology obtained with the proposed method has 11 two-port circuit elements, achieved after 20,285 circuit evaluations. It is a very compact topology and matches the specifications, as shown in Fig. 12. Besides this high-quality solution, the designer has a set of trade-off solutions available into the elite population (Pareto front). For instance, another good solution in the Pareto front has 8 circuit elements, although the frequency response was slightly worse. It can be compared with the result presented in (Lai & Jeng, 2006), which uses a mono-objective hybrid encoded Genetic Algorithm. In (Lai & Jeng, 2006), the best solution was composed by 10 circuit elements, and was achieved after 300 generation, with a population size of 200, or 60,000 circuit evaluations. Results as good as the ones in (Lai & Jeng, 2006) were achieved with a lower number of circuit evaluations and moreover, the proposed method produced filters smaller than those presented in (Tsai & Hsue, 2004).

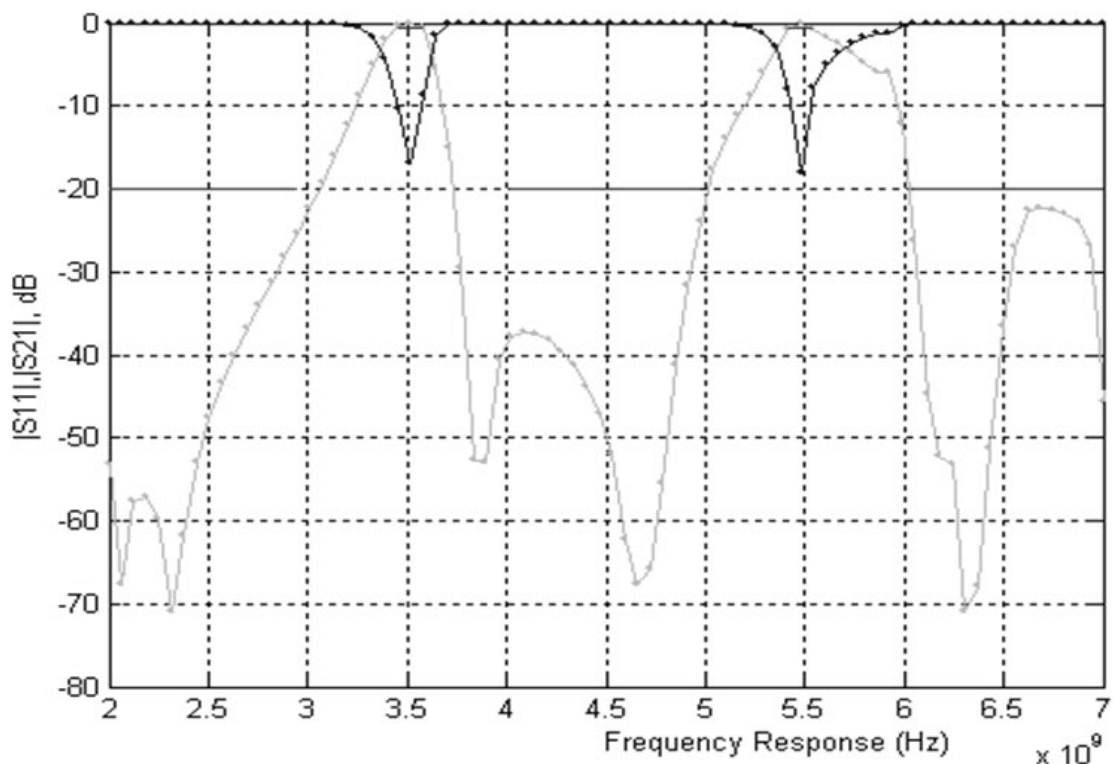

Fig. 12. The frequency responses of one Pareto solution. The thick black line represents the user-defined mask. The gray line is the transmission response $|S_{21}|$. The black line is the reflection response $|S_{11}|$.

4. Conclusions

The circuit design to meet increasingly stringent specifications is a demand of modern applications. The evolutionary methodologies applied to the problem of synthesis of analog circuits have been producing competitive solutions with the solutions found by conventional techniques developed by experts. However, it is a difficult problem, requiring a balance between optimizing topologies and parameters and also presents several open issues. The hybrid evolutionary method presented in this chapter has evolved over time (Dantas, 2006a, 2006b, 2007). The latest proposal, with representation for circuit elements of two ports, using the Positional Matrix, is appropriate to obtain arbitrary topologies and parameters of circuits using small populations, few generations and with a low computational cost. The proposed method has proved robust and flexible. We performed several tests for filters with bandwidth of various sizes, with the desired response with differing degrees of asymmetry, multi-bands, broadband, all with promising results. This indicates that the method is able to generate various compact topologies that meet the design specifications and shows characteristics such as regularity and controlled structural complexity. The circuit elements used, provided by the user, were reorganized during the evolution process into new blocks, appearing with some degree of redundancy in the formation of the final circuit. This means that the evolutionary strategy developed is able to keep the size of the circuit under control, and is still effective in maintaining an elite of better building-blocks to compose the next generation of circuits.

Another important aspect is the choice of a bi-objective approach, which provides a trade-off between performance and size of circuits. Miniaturization is a requirement of current

applications, depending on the development of new materials and manufacturing technologies. On the other hand, after the optimization process, the designer has at his disposal a set of solutions in the Pareto front. He can thus use their expert knowledge to choose the best solution, taking into account the application at his hand.

In future works, we intend to work with multiple objective functions, using the classifying process of the NSGA-II method, but making a preference-based articulation along the evolutionary process. In the synthesis of a multi-band filter, for example, each band may correspond to an objective-function and to each of them could be assigned a preference level.

5. References

- Antoniou, A. & Lu, W. (2007). *Practical Optimization: Algorithms and Engineering Applications*, 1st Ed, Springer, ISBN 0387711066.
- Cameron, R.J.; Faugere, J.C.; Rouillier, F & Seyfert, F. (2007). Exhaustive Approach to the Coupling Matrix Synthesis Problem And Application to the Design of High Degree Asymmetric Filters. *International Journal of RF and Microwave Computer-Aided Engineering - Special Issue on RF and Microwave Filters, Modeling and Design*, Vol. 17, No. 1, January 2007, 4-12, ISSN 10964290.
- Chen, C. & Hsu, C. (2006). Design of a UWB Low Insertion Loss Bandpass Filter with Spurious Response Suppression. *Microwave Journal*, Vol. 49, No. 2, February 2006, 112-116.
- Dantas, M.; Brito, L. & Carvalho, P.. (2006a). Biobjective Hybrid Evolutionary Algorithm Applied to Resonator Filters of Arbitrary Topology. *13th IEEE International Conference on Electronics, Circuits and Systems*, Nice, September 2006, Vol. 1, 1-5.
- Dantas, M.; Brito, L. & Carvalho, P.. (2006b). Multi-objective Memetic Algorithm Applied to the Automated Synthesis of Analog Circuits. *Lecture Notes in Computer Science*, Vol. 4140/2006, 258-267.
- Dantas, M., Brito, L., Carvalho, P., Abdalla, H. (2007). Design of Microwave Filters Topologies using a Hybrid Evolutionary Algorithm. *Journal of Microwaves and Optoelectronics*, Vol. 6, 295-309, ISSN 21791074.
- Dastidar, T. R.; Chakrabarti, P. P. & Ray, P. (2005). A Synthesis System for Analog Circuit Based on Evolutionary Search and Topological Reuse. *IEEE Transactions on Evolutionary Computation*, April 2005, Vol. 9, No. 2, 211-224.
- Deb, K.; Pratap, A.; Agarwal, S. & Meyarivan, T. (2002). A Fast and Elitist Multiobjective Genetic Algorithm: NSGA-II. *IEEE Transactions on Evolutionary Computation*, April 2002, Vol. 6, No. 2, 182-197.
- Goldberg, D. (1989). *Genetic Algorithms in Search, Optimization, and Machine Learning*, 1st Ed., Addison-Wesley Professional, ISBN 0201157675.
- Grimbleby, J. B. (2000). Automatic Analogue Circuit Synthesis using Genetic Algorithms. *IEEE Proceedings: Circuits, Devices and Systems*, Vol. 147, No. 6, 319-323, December 2000, ISSN 1350-2409.
- Holland, J. (1992). *Adaptation in Natural and Artificial Systems*, The MIT Press, ISBN 0262581116.
- Hou, H., Chang, S. & Su, Y. (2005). Practical Passive Filter Synthesis using Genetic Programming. *IEICE Trans. Electron.*, Vol. E88, No. 6, June 2005, 1180-1185, ISSN 09168524.

- Hsu, M. & Huang, J. (2005). Annealing algorithm applied in optimum design of 2.4 GHz and 5.2 GHz dual-wideband microstrip line filters. *IEICE Trans. Electron.*, Vol. E88-C, No. 1, January 2005, 47-56, ISSN 09168524.
- Hu, J., Goodman, E. & Rosenberg, R. (2004). Robust and Efficient Genetic Algorithms with Hierarchical Niching and a Sustainable Evolutionary Computation Model. *Proc. of the Genetic and Evolutionary Computation Conference, Lecture Notes in Computer Science, Springer, GECCO-2004*, Seattle, June 2004, Part I, 1220-1232.
- Im, C., Jung, H. & Kim, Y. (2003). Hybrid Genetic Algorithm for Electromagnetic Topology Optimization. *Transactions on Magnetics*, September 2003, Vol. 39, No. 5, 2163-2169, ISSN 00189464.
- Jun, D., Lee, H., Kim, D., Lee, S. & Nam, E. (2005). A Narrow Bandwidth Microstrip Band-Pass Filter with Symmetrical Frequency Characteristics. *ETRI Journal*, Vol. 27, No. 5, October (2005), 643-646.
- Koza, J., Andre, F. & Keane, M. (1996). Automated Design for Both Topology and Components Values of Electrical Circuits using Genetic Programming. *Genetic Programming 1996: Proceedings of the First Annual Conference*, 123-131, July 1996, Stanford University, Cambridge MA..
- Lai, M. & Jeng, S. (2006). Compact Microstrip Dual-Band Bandpass Filters, Design Using Genetic-Algorithm Techniques. *IEEE Transactions on Microwave Theory and Techniques*, Vol. 54, No. 1, , January 2006, 160-168, ISSN 00189480.
- Lenoir, P.; Bila, S.; Seyfert, F.; Baillarget, D. & Verdeyme, S. (2006). Synthesis and Design of Asymmetrical Dual-band Bandpass Filters Based on Network Simplification. *IEEE Transactions on Microwave Theory and Techniques*, Vol. 54, No. 7, July 2006, 3090-3097, ISSN 00189480.
- Levy, R.; Fellow, L. & Petre, P. (2001). Design of CT and CQ Filters Using Approximation and Optimization. *IEEE Transactions on Microwave Theory and Techniques*, Vol. 49, No. 12, December 2001, 2350-2356, ISSN 00189480.
- Mesquita, A.; Salazarand F. & Canazio, P. (2002). Chromosome Representation through Adjacency Matrix in Evolutionary Circuit Synthesis. *NASA Conference on Evolvable Hardware*, 102-112, ISBN 0769517188, July 2002.
- Michalewicz, Z. & Fogel, D. (2002). *How to Solve It: Modern Heuristics*. 2nd Ed., Springer, ISBN 9783540224945.
- Nishino, T. & Itoh, T. (2002). Evolutionary Generation of Microwave Line-Segment Circuit by genetic Algorithms. *IEEE Transactions on Microwave Theory and Techniques*, Vol. 50, No. 9, September 2002, 2048-2055, ISSN 00189480.
- Shin, A. & Histoshi, I. (2003). Variable length Chromosomes for Analog Evolvable Hardware. In: *Advances in Evolutionary Computing: Theory and Applications*, A. Ghosh and S. Tsutsui, 643-662, Springer-Verlag, ISBN 3540433309.
- Tsai, L. & Hsue, C. (2004). Dual-Band Bandpass Filters using Equal-Length Coupled-Serial-Shunted Lines and Z-Transform Technique. *IEEE Transactions on Microwave Theory and Techniques*, Vol. 52, No. 4, April 2004, 1111-1117, ISSN 00189480.
- Uhm, M.; Lee, J.; Yom, I. & Kim, J. (2006). General Coupling Matrix Synthesis Method for Microwave Resonator Filters of Arbitrary Topology. *ETRI Journal*, Vol. 28, N. 2, April 2006, 223-226.
- Wang, H.; Zhang, A. & Fang, D. (2005). The Design of Cross-Coupled Microstrip Filter Exploiting Aggressive Space Mapping Technique. *Microwave Conference – APMC 2005 Proceedings*, Vol. 5, 1-3, December 2005.

- Zebulum, R.; Pacheco, M. & Vellasco, M. (1998). Comparison of Different Evolutionary Methodologies Applied to Electronic Filter Design. *Proceedings of the IEEE International World Congress on Computational Intelligence, ICEC'98*, 434-439, Alaska, May 1998.
- Zhang, H. (2007). *Compact, Reconfigurable, and dual-band microwave circuits*. Doctorate Thesis, Dep. of Electronic and Computer Engineering, 1-187, Hong Kong.

IntechOpen

IntechOpen

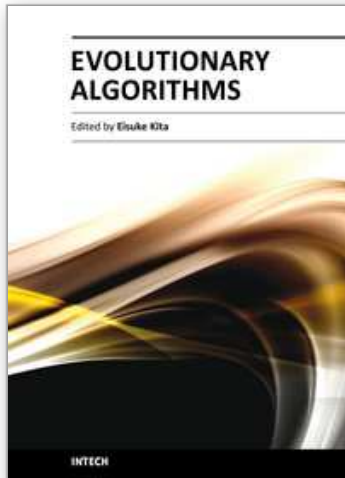

Evolutionary Algorithms

Edited by Prof. Eisuke Kita

ISBN 978-953-307-171-8

Hard cover, 584 pages

Publisher InTech

Published online 26, April, 2011

Published in print edition April, 2011

Evolutionary algorithms are successively applied to wide optimization problems in the engineering, marketing, operations research, and social science, such as include scheduling, genetics, material selection, structural design and so on. Apart from mathematical optimization problems, evolutionary algorithms have also been used as an experimental framework within biological evolution and natural selection in the field of artificial life.

How to reference

In order to correctly reference this scholarly work, feel free to copy and paste the following:

Maria J. P. Dantas, Adson S. Rocha, Ciro Macedo, Leonardo da C. Brito, Paulo C. M. Machado and Paulo H. P. de Carvalho (2011). Evolutionary Optimization of Microwave Filters, Evolutionary Algorithms, Prof. Eisuke Kita (Ed.), ISBN: 978-953-307-171-8, InTech, Available from: <http://www.intechopen.com/books/evolutionary-algorithms/evolutionary-optimization-of-microwave-filters>

INTECH
open science | open minds

InTech Europe

University Campus STeP Ri
Slavka Krautzeka 83/A
51000 Rijeka, Croatia
Phone: +385 (51) 770 447
Fax: +385 (51) 686 166
www.intechopen.com

InTech China

Unit 405, Office Block, Hotel Equatorial Shanghai
No.65, Yan An Road (West), Shanghai, 200040, China
中国上海市延安西路65号上海国际贵都大饭店办公楼405单元
Phone: +86-21-62489820
Fax: +86-21-62489821

© 2011 The Author(s). Licensee IntechOpen. This chapter is distributed under the terms of the [Creative Commons Attribution-NonCommercial-ShareAlike-3.0 License](#), which permits use, distribution and reproduction for non-commercial purposes, provided the original is properly cited and derivative works building on this content are distributed under the same license.

IntechOpen

IntechOpen