

We are IntechOpen, the world's leading publisher of Open Access books Built by scientists, for scientists

4,800

Open access books available

122,000

International authors and editors

135M

Downloads

Our authors are among the

154

Countries delivered to

TOP 1%

most cited scientists

12.2%

Contributors from top 500 universities



WEB OF SCIENCE™

Selection of our books indexed in the Book Citation Index
in Web of Science™ Core Collection (BKCI)

Interested in publishing with us?
Contact book.department@intechopen.com

Numbers displayed above are based on latest data collected.
For more information visit www.intechopen.com



Process Monitoring of Polymer Systems by using Near-Infrared Spectroscopy

Wei Li

*School of Materials Science and Engineering, Shenyang Aerospace University
People's Republic of China*

1. Introduction

Polymers are a very important class of organic materials. Nowadays, polymers have been widely used in many fields due to their specific and excellent properties. They have become increasingly significant in our lives. With the growing demands on the quality of polymer products as well as reduction of costs in production and processing, the fast, accurate and reliable monitoring methods become more and more important.

The traditional off-line monitoring methods have many limitations, one of which is lag effect. This is mainly because sampling and lab testing can be very time-consuming and for some tests a long time is required before the results are obtained. It is obviously that there is a large time gap between sampling and obtaining the results. Meanwhile, the reaction or processing of unknown quality polymer continues. Hence, the sample and end product don't have the same properties, which can result in large amounts of wasted material (Rohe et al., 1999). Another problem is that the sample analysed is small and as a result might not have all the properties that the bulk possessed (Coates et al., 2003). Due to these limitations and problems, the off-line measuring methods are clearly unsuitable for the process monitoring.

Undoubtedly, it is exciting to observe that the spectroscopic techniques can meet the above demands required by the process monitoring of the polymer systems. The vibrational spectroscopy is ideally suited to qualitative and quantitative analysis of polymers. Moreover, it can also give valuable information at the molecular level about the reactions extent and the products quality. It deserves to be specially noted that Near-infrared (NIR) spectroscopy is a promising tool among the spectroscopic techniques.

Near-infrared spectroscopy lies between the visible and mid-infrared regions of the electromagnetic spectrum, whose region extends from about 12,500-4000 cm^{-1} . This region encompasses bands that result from the harmonic overtones of fundamental and combination bands associated with hydrogen atoms, which is why compounds containing CH, OH and NH bonds lend themselves favourably to analysis by NIR spectroscopy. However, NIR spectroscopy is comparatively weaker than mid-infrared, and contains molecular structure information seriously overlapped which resulted in the silence of its research in the early stage.

The modern earliest analytical applications of NIR spectroscopy were reported in the early 1960's (Butler & Norris, 1960; Norris & Butler, 1961). Nowadays, NIR spectroscopy

technology has been extensively and effectively employed in a variety of fields, including areas of agricultural, food, chemical, petrol, pharmaceuticals, textiles, cosmetics and medical, etc. The rapid growth of the technology can be attributed to the emergence of high precision spectroscopic instruments with very high signal to noise ratios to detect minute differences in the spectra and high-speed computers to carry out the complex calculations involved in multivariate analysis (Norris 1989). On the whole, NIR spectroscopy has several advantages compared to traditional laboratory techniques, such as rapid speed and reliability of determinations, rapid and easy sample preparation, multiplicity of analysis with one operation, simple operation, and non-destructive analysis (Schultz & Burns, 1990). The wide applicability and potential of NIR spectroscopy for polymer analyses have been recognized (Lachenal & Ozaki, 1999; Lee & Kradjel, 2007). NIR spectra contain information related to polymer properties (Lachenal, 1995) such as composition, conformation and crystallinity, therefore NIR can be widely applied for various polymer analyses. Especially, the recent progresses of modern fiber-optic-based NIR spectrometers opened up new perspectives for process monitoring in the polymer fields. The probes can be placed at very harmful working environments, while the spectrometer locates still in a process monitoring room. The use of probes connected to spectrometer via optical fibers allows direct measurements in the product line without interference in the production process. Due to the diversity of available probes, such as transmission mode and diffusive reflectance mode, the NIR technique can be used to analyze almost any kind of polymer, including melts, solutions or solid powders, etc.

The main objective of this chapter is to introduce the use of NIR spectroscopy as an alternative technique for process monitoring of various polymer systems. Firstly, some successful applications of NIR spectroscopy used in the polymers polymerization, polymers processing and polymers curing are described. Then, the quality monitoring of polymer prepreps in the production is presented.

2. Monitoring the polymerization process

In the polymerization process, the minimal changes of the process parameters may cause the great property differences of polymer products. Thus, the polymerization process could not be regulated precisely by only controlling a few process parameters, and the product quality is likely unable to meet the requirements. The ideal solution method is to measure the polymer properties continuously and adjust the processing parameters promptly by the measuring results. Among the developed techniques, the applications of NIR have been reported in the bulk, solution, emulsion, and suspension polymerizations, including monitor the compositions, monomer conversion, molecular weight averages, and average particle sizes, etc.

2.1 Bulk polymerization

A short-wavelength NIR spectroscopy was utilized for in-situ monitoring the monomer conversion during the bulk polymerization of methyl methacrylate in a mold (Aldridge et al., 1993). Using a retroreflecting array, the illumination beam was modified to pass through the sample twice in order to reduce lensing effects of the mold and Schlieren patterns caused as the reaction progressed. It was observed that the disappearance of the third overtone stretch of the CH of the vinyl group at 868nm and the concomitant appearance of the CH of

the methylene group at 890nm were attributed to the monomer conversion. The spectral data at these two wavelengths showed an excellent correlation to the monomer percent conversion.

The monomer conversion of a styrene bulk polymerization was monitored on-line with NIR spectroscopy (Lousberg et al. 2002). A flow cell was utilized for sampling. The influence of the temperature of the reaction mixture on the predicted conversion was minimized by building a global multivariate calibration model. The results showed that on-line conversion monitoring with NIR offered overall an excellent accuracy (~0.32% conversion), which is comparable to the known accuracy of the at-line size-exclusion chromatography reference method. Their study also proved that the method is insensitive to either changes of the molar mass distribution or of the temperature (changes of at least 10°C) of the reaction mixture and is able to detect abnormal behavior during a batch quickly.

2.2 Solution polymerization

A fiber-optic near-infrared (NIR) spectroscopy was used to monitor the monomer conversion and the weight-average molecular weight of the polymer produced during solution polymerization of methyl methacrylate (MMA) (Cherfi & Fevotte, 2002; Cherfi et al., 2002). NIR spectra were recorded during batch and semi-continuous reactions using an in situ transmission probe. Off-line gravimetry and gel permeation chromatography (GPC) were used as reference methods to provide the conversion and the average molecular weight data set required for the calibration procedure. The calibration model was generated using PLS method. The model predictions were then validated for different operation conditions in both batch and semi-batch modes. The conversion was predicted during three validation experiments with an average standard error of prediction (SEP) of 2.1%, and the on-line evaluation of weight-average molecular weight was obtained with an average relative SEP of 5.7%.

The NIR spectroscopy used for in-line and in situ monitoring and control of monomer conversion and average molecular weight of polymer resins was presented in the styrene solution polymerization system (Fontoura et al., 2003). By using a Kalman filter state estimator and an accurate first-principle model, the control loop could be successfully closed to track desired monomer values and average molecular weights. The experimental results showed that it was feasible to use NIR spectroscopy for the simultaneous control of monomer conversion and polymer average molecular weight.

2.3 Emulsion polymerization

The NIR spectroscopy was used for the simultaneous in-line and in situ monitoring of monomer (methyl methacrylate and butyl acrylate) and polymer concentrations in the reaction medium during seeded semibatch emulsion copolymerizations (Vieira et al., 2002a). The NIR spectra were collected by a dispersive instrument equipped with a transreflectance probe. The developed PLS calibration models were successfully for prediction of the major constituents of the emulsion. Based on the use of the NIR signal as process feedback, a control approach was constructed (Vieira et al., 2002b). The results showed that the control of copolymer composition and average molecular weights were achieved simultaneously.

The semi-continuous styrene/butyl acrylate emulsion copolymerization reactions were monitored by NIR spectroscopy (Reis et al., 2004). A transreflection probe was immersed in the reaction medium. A set of nine reactions with slightly different formulations were

carried out. The results of five reactions were used to fit a SIMPLS model, and the four remaining reactions were monitored in order to evaluate the model performance for estimation of important variables and latex properties. The study showed that simultaneous monitoring of monomer conversion, copolymer composition, particle number and average number of radicals per polymer particle was performed with success. Meanwhile, it was found that the calibration model for polymer particle size estimation was more susceptible to failure. The poor prediction of average particle sizes was also obtained in other study (Gossen et al., 1993 & Vieira et al., 2001). Obviously, the prediction of average particle sizes in emulsions systems from NIR spectra is a very controversial issue. Reis et al. think that there is a correlation between the average polymer particle size and NIR spectra, but it is not fully understood how the polymer particle size affects NIR spectra (Reis et al., 2004).

2.4 Suspension polymerization

NIR spectroscopy was used for in-line evaluation and for control and design of average particle sizes during styrene suspension polymerizations carried out in the batch mode (Santos et al., 1998 & Santos et al., 2000). It was found that the NIR spectra were sensitive to changes of the average particle size. The calibration models developed for the final average particle sizes had high prediction accuracy, and then they were used as references for implementation of an in-line procedure for control of average particle sizes. The study showed that this NIR technique allowed the successful design and real-time control of particle sizes in lab-scale styrene suspension polymerization reactors.

The morphological characteristics of PVC resins such as bulk density, cold plasticizer absorption and average particle diameter was first in-line and in real time monitored by NIR spectroscopy during suspension polymerization processes (De Faria et al. 2010a). The NIR spectra obtained at different experimental conditions were sensitive to changes of the PVC properties. The calibration models developed by PLS regression was capable to predict the morphological parameters accurately. It was shown that the modification of operation variables during the batch led to modification of the final morphological properties of the powder. Their study indicated that the morphology of PVC grains could be manipulated along the batch and that advanced NIR-based control procedures could be implemented for control of the morphological properties of PVC resins (De Faria et al. 2010b).

3. Monitoring the polymer extrusion processes

Extrusion is a major process for manufacture and fabrication of polymers. In the extrusion process, the resin is gravity fed from a top mounted hopper into the barrel of the extruder. Additives such as fillers, colorants and UV inhibitors are often used and can be mixed into the resin prior to arriving at the hopper. Standard chemical engineering measurements such as temperature, pressure, motor speed, and torque are used to monitor and control extruders. However, these process parameters can not ensure the product quality sufficiently due to the lack of information about polymer properties and composition. The extreme process conditions, which include high temperatures, high pressures, and harsh chemical environment, have restricted some analytical methods suitable for extrusion monitoring. The unique features of NIR spectroscopy make it adapted for such operation process. The applications of NIR spectroscopy have been realized in the polymer extrusion

processes for monitoring the polymer composition, additive concentration and flow properties, etc.

The MIR, NIR and Raman spectroscopy was used for monitoring of single screw extrusion of high density polyethylene and polypropylene blends (Coates et al., 2003). These vibrational spectroscopic techniques were then compared with in-line ultrasound velocity measurements. The in-line transmission NIR used a specifically designed stainless steel extruder section, just prior to the die. The NIR measurements for sequential extrusion showed that the absorption bands within $5150\text{-}6100\text{cm}^{-1}$ were changed obviously when the blend compositions were changed from 100 wt% PP to 50 wt% PP:50 wt% PE, then to 100 wt% PE. Analysis for the 10 wt% steps in blend concentration, using partial least squares regression analysis of the predicted concentration of each polymer, gave a standard deviation of prediction of ± 0.39 wt%. Among the vibrational spectroscopy techniques explored, in-line NIR provided the most accurate assessment of blend ratio change for the experimental conditions.

A measurement system for in-line NIR spectroscopy for polymer extrusion processes was developed (Rohe et al., 1999; Rohe et al., 1998), which consisted of a measurement head adapted to a single screw extruder with integrated fibre optic probes (Fig.1) and an AOTF-NIR spectrometer. This system was capable of measuring different polymer compositions as demonstrated for PE/PP blends. Transmission measurements at typical extrusion conditions, where the temperature was up to 300°C and the pressure was up to 35 MPa, yielded good results with respect to mechanical and optical properties of the probes. The deviations between predicted and actual polymer composition were quite low. Fischer et al. (1997) have applied NIR spectroscopy for continuous monitoring the composition of polypropylene/ethylene vinyl acetate copolymer.

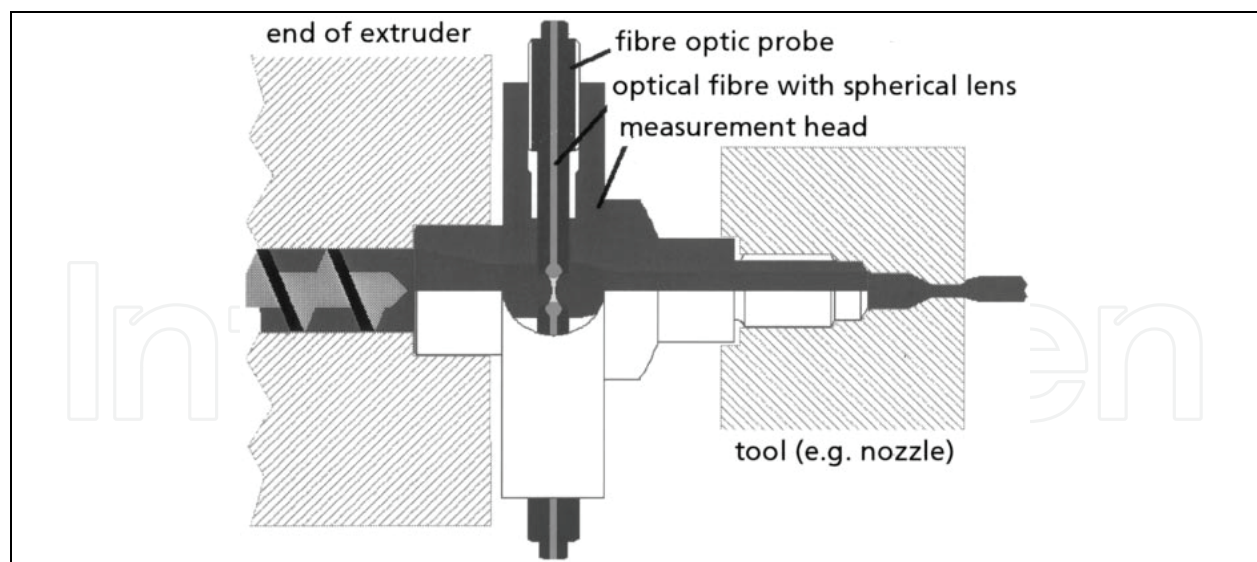

Fig. 1. Scheme of measurement head with integrated fibre optic probes for in-line measurement (Rohe et al., 1999)

Nagata et al. (2000a) developed an on-line sensor using NIR spectroscopy for monitoring CO_2 concentration in polymeric extrusion foaming processes. NIR absorption spectra were acquired by a probe installed at the foaming extruder die. The calibration curve relating the absorbance spectrum at 2019 nm to the dissolved gas concentration was derived so as to

infer dissolved CO₂ gas concentration on-line from measured NIR spectra. Experimental results showed that the dissolved CO₂ concentration was successfully estimated in the molten polymer. The similar NIR system was also used for in-line monitoring the polyethylene density in the extrusion process (Nagata et al., 2000b).

The monitoring of additives content has also been studied. Batra et al. (1994) used NIR spectroscopy for monitoring the concentration of titanium dioxide (TiO₂) in molten PET. The NIR spectra were collected in-line by using a flow cell, housing two fiber-optic probes, and mounted downstream of the extruder. Because the presence of TiO₂ caused the scattering of light that resulted in a systematic baseline shift, the baseline shifts were correlated to the TiO₂ concentration data. PLS regression was applied to build models. Standard error of prediction values was about 1%. During the PP extrusion, Fischer et al. (1997) utilized NIR spectroscopy for monitoring the content of pulverized chalk in the range of weight concentrations from 0 to 40%.

In an extrusion process, the rheological properties of molten poly(ethylene vinyl acetate) (EVA) copolymers were in-line monitored by using NIR spectroscopy (Hansen & Vedula, 1998; Vedula & Hansen, 1998). The NIR transmission spectra of molten polymer flow stream were collected in a flow cell attached to a single-screw extruder. The calibration models were built on spectra in 1620-1840nm wavelength region. The SEP was 0.46 wt% for melt flow index (MI). The dynamic linear viscoelastic properties were also estimated.

4. Monitoring the polymer curing process

The final properties of thermosetting resins not only depend to a large extent on the chemical nature of the monomers utilized, but also depend on the curing process. The reason is that the properties of thermosetting resins depend on the features of the network such as the sort of hardeners, cross-link density and residual monomer content. Therefore, monitoring of the curing process is benefit for the control of the structural of the resulting three-dimensional network. The applications of NIR spectroscopy for monitoring the curing of two important types of thermosetting resins, epoxy resin and bismaleimide resin, are illustrated herein.

4.1 Epoxy resin

The use of NIR spectroscopy to characterize the cure reactions of epoxy resin began in the late 1950's. The two characteristic bands for the terminal epoxide group were identified, which located in 6061 and 4546 cm⁻¹ (Goddu & Delker, 1958). The epoxy/amine cure reactions were investigated by using NIR spectroscopy (Dannenberg, 1963). The epoxide group and hydroxyl group absorptions were quantified, and the effects of hydrogen bond formation on the spectra obtained were addressed. Xu et al. (1994) used in-situ NIR spectroscopy to investigate the cure mechanisms of epoxy/aromatic amine. The mechanistic models and the rate determining step were confirmed. The reaction rate constants obtained over a temperature range from 383 to 443 K demonstrated an Arrhenius temperature dependence and the corresponding activation energies and pre-exponential factors have been determined. Their study concluded that the cure rates were determined by the autocatalytic behavior of epoxy/aromatic amine system.

The remote fiber optic near-infrared spectroscopy was used for in situ real-time monitoring of the reaction kinetics of various epoxy/amine formulations (Mijović et al., 1995). In the

curing reaction, the systematic changes in major absorption peaks of epoxy (4530 and 6080 cm^{-1}), amine (5056 and 6670 cm^{-1}) and hydroxyl (7000 and 4800-4900 cm^{-1}) were testified. The extent of reaction at any time t was calculated from the initial areas of epoxy and reference peaks, $A_{\text{epoxy},0}$ and $A_{\text{ref},0}$, respectively, and their corresponding values at time t , $A_{\text{epoxy},t}$ and $A_{\text{ref},t}$, according to the following equation:

$$\alpha = 1 - [(A_{\text{epoxy},t})(A_{\text{ref},0})] / [(A_{\text{epoxy},0})(A_{\text{ref},t})] \quad (1)$$

The peak at 4530 cm^{-1} was utilized to monitor the epoxy groups, and the peak due to the CH stretching vibration of the benzene ring at 4673 cm^{-1} was used as a reference. The effect of chemical structure and functionality of the formulation components on the reaction rate was shown. Moreover, the characteristic changes in the NIR spectra of multifunctional formulations were observed near the gel point and it was suggested that these could be used to identify gelation.

Park et al. (2000) studied the cure behavior and the reaction kinetics of epoxy resin which cured with an anhydride hardener and catalyzed by a cationic thermal latent initiator, N-benzylpyrazinium salts. The conversions of epoxy and hydroxyl groups were monitored by changes in the intensity of each band at 4530 cm^{-1} and 7000 cm^{-1} , respectively measured at different temperatures. The results revealed that the time dependence of the band intensity exhibits a sigmoidal-shape consistent with the autocatalytic reaction mechanism. From the extent of reaction which calculated from NIR absorption band at 4530 cm^{-1} , it was concluded that the cure reactions of epoxy resins were highly exothermic in nature and the cure kinetics was dependent on the temperature, resulting in the activity of catalyst.

The simultaneous dielectric/NIR spectroscopy was used to monitor the curing reaction of PMMA-modified epoxy resins (Kortaberria et al., 2004). The optical fiber NIR spectra generated in the remote mode was used for the quantitative evaluation of reaction kinetics and the extent of reaction was calculated from the absorption intensities of characteristic peaks (at 4530 cm^{-1} and 5056 cm^{-1}). The primary amines showed greater reactivity than secondary ones, being the vitrification process controlled by the secondary amine addition to the epoxy ring. The effect of the modifier as well as that of the cure temperature on the extent of reaction curves was studied, showing that the amount of modifier retarded curing reaction.

4.2 Bismaleimide resin

Mijović J. & Andjelić S. (1996) used NIR spectroscopy to investigate the mechanism and kinetics of cure of a two-component bismaleimide formulation, which composed of 4,4'-methylenebis[maleimidobenzene] and 2,2'-diallylbisphenol A. In-situ real time study of the progress of reaction was conducted in the temperature range from 140 to 250°C. The principal reaction observed was an alternating copolymerization involving maleimide and allyl double bonds. Maleimide homopolymerization was detected only in the initial stages of reaction at temperatures above 200°C. The extent of self-condensation (or etherification) of hydroxyl groups on the allyl component, which leads to cross-linking, was observed to vary with reaction temperature, suggesting a path to tailor-making networks with desired morphology and physical/mechanical properties.

The cure of bismaleimide monomer, 1,1'-(methylenedi-4,1-phenylene) bismaleimide (MDP-BMI) with aromatic diamines, such as 4,4'-diaminodiphenylmethane (DDM), was studied

by using in-situ NIR spectroscopy (Hopewell et al., 2000). The concentrations of the various functional groups in the resins with respect to time were measured during isothermal cure. For MDP-BMI/DDM resins, the secondary amine was found to be less reactive than the primary amine in the nucleophilic addition reaction with maleimide double bonds. The homopolymerization of maleimide was moderately rapid in the early stages of cure in maleimide-rich formulations, and the rate slowed dramatically at higher conversion. Differences in the reactivities of different resin formulations were observed when the diamine was changed from DDM to 4, 4'-diaminodiphenylsulphone (DDS).

5. Quality control of prepreg manufacture

Fiber reinforced thermosetting matrix composites have been employed in military and aerospace applications due to their high performance. Many of these composites are made from the prepregs. Prepreg is the important intermediate of polymeric composites, and its quality will greatly influence the properties of final composite products. Thus it is important to control the quality in the manufacture process of prepreg. The volatile content, the resin content and the pre-curing degree of resin, i.e. three factors, are important to ensure the quality of the prepreg. Traditional analysis methods such as solvent extraction, burn-off and acid digestion are often used to measure the three factors. However, these methods are unsuitable for continuous measurement during the manufacture of prepregs due to the excessive time required and the destructive analysis of the specimen (Huang et al., 1997). So far, a series of process monitoring techniques have been developed to measure the prepregs quality.

5.1 Status of process monitoring technique for the prepreg quality

1. β -ray transmission technique (Huang et al., 1997; Huang et al., 2003)

The theoretical basis of β -ray monitoring the prepreg quality is that the energy is attenuated during the penetration of the prepreg by β -particles. The attenuation of transmitted radiation is related to the thickness of prepreg:

$$I=I_0e^{-\mu\rho x} \quad (2)$$

where, I_0 and I are the energy before and after β -particle penetration of the prepreg, respectively; μ is the absorption coefficient of the prepreg; ρ is the density of the prepreg; x is the thickness of the prepreg. Because the resin content is related to the prepreg thickness, the resin content is obtained by determining the thickness.

Fig.2 is the schematic of monitoring resin content of prepreg by β -ray technique (Huang et al., 1997). The prepreg specimen was passed through the middle between the β -ray source and the detector. In the test, a series of output signal of prepreg which had different resin content were obtained firstly. Then the relationship between resin content obtained from chemical method and output signal was established. Finally, the unknown specimen was determined according to the above relationship.

The studies indicated that the β -ray technique always holded high accuracy in determining the resin content with broad range (Huang et al., 1997; Huang et al., 2003). With the nature of rapid and non-contact features, the β -ray technique can be used in the product line to continuously monitor the resin content of prepreg. It was necessary to take the protective measures because the radioactive element was used.

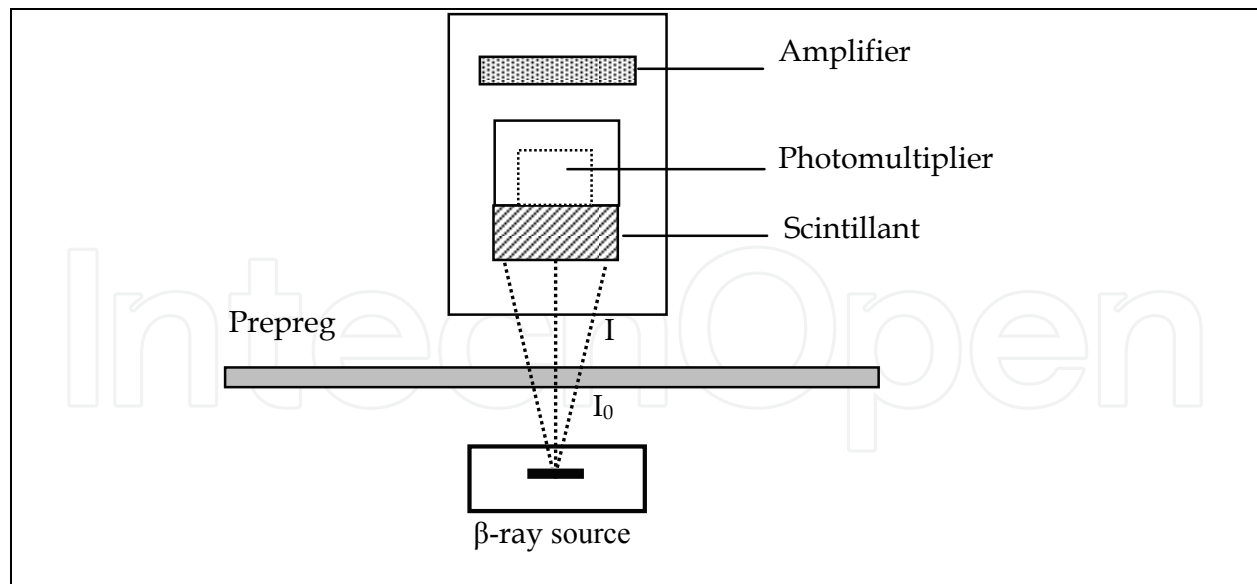

Fig. 2. Schematic of monitoring resin content of prepreg by β -ray technique (Huang et al., 1997)

2. γ -ray transmission technique (Teagle, 1983)

The principle of monitoring the resin content by γ -ray transmission is similar to the one by β -ray technique. When γ -ray penetrate the prepreg, the photoelectric effect is occurred accompanied with Compton Effect and electron effect. The ray intensity is attenuated due to these three effects, the attenuation rule is accord with the exponent rule. Co60, Cs137 and Cd190 are usually used as the radiographic ray. The scintillation counter and the geiger counter are often used as detector. Due to the low resin density and the low upper measuring limit, the high precision of monitoring the resin content is difficult to obtain by using γ -ray transmission technique.

3. Photometry monitoring method (Smithgall, 1990)

The principle of monitoring the resin content by photometry technique is based on the light transmission. When the light passes through the prepreps, the transmitted light intensity is varied because the resin content of prepreps is different. Thus, the brightness received by the camera is different. Moreover, the change of resin content is judged by the different image. In the operation process, the image of prepreg which has the certain resin content is regarded as the standard image. Comparing the measured image with the standard one, the resin content is controlled by adjusting the processing parameters automatically.

The photometry technique is an on-line and non-contact monitoring method. Because its detector system is not limited to the running speed, this method is adaptable for the continuous production of the prepreg. However, the resin content is determined by receiving the transmitted light, the method is not used for the nontransparent carbon prepreg. For the transparent glass prepreps and semitransparent aramid prepreps, the ideal measurement accuracy is obtained.

4. Ultrasonic monitoring technique (Ma et al., 1991; Smith et al., 1990)

When the ultrasonic waves propagate in the prepreps, the ultrasonic delay is a function of prepreg within a definite range:

$$S_c = (S_m - S_f)V_m + S_f \quad (3)$$

where, S_c , S_m and S_f are the ultrasonic delay of prepreg, resin and fibre, respectively; V_m is the volume fraction of resin. If the ultrasonic delay of resin and fibre were known, the resin content could be calculated by the measured ultrasonic delay of prepreg.

In order to eliminate the effects caused by the air medium and the voids of prepreg, it is necessary that the ultrasonic probe and prepreg contact intimately under the force. Apparently, the ultrasonic monitoring method belongs to the contact measurement. It has the features of rapid and accurate when this method is used to determine the rather wide and thick prepreg, and the on-line monitoring can be realized in the production process. However, the accuracy of result is decided by the contact situation of the prepreg specimens and the ultrasonic probe, the partial failure on the testing prepreg may be occurred. In addition, the monitoring results are possibly occasional due to the semi soft feature of prepreg.

5. Infrared spectroscopy

The resin content and curing degree of the glass/epoxy prepreg has been continuously determined and controlled by using infrared transmission spectroscopy (Amy & Jiri, 1995).

The wavenumbers at 4529cm^{-1} (absorption band of epoxy group) and 4055cm^{-1} (absorption band of methyl group) were generated by the filter. The prepreg was shined by using pulse mode, and the intensity of transmission signal was detected. The resin content of prepreg is calculated by the linear relation between the resin content and the logarithm of the transmission signal intensity at 4529cm^{-1} . The curing degree was obtained by using the ratio of the transmission signal intensity at 4529cm^{-1} to that at 4055cm^{-1} . By using the IR technique in the production, the variations of resin content and curing degree can be controlled within the $\pm 3\%$ in the 366 meters length range.

From the above depiction, it is apparently known that the volatile content could not be determined although the resin content and the pre-curing degree have been monitored successfully by the above mentioned methods. In the opened literatures (Li et al., 2005; Li et al., 2006a; Li et al., 2008), NIR spectroscopy in conjunction with chemometrics method has been applied to the monitoring of the three quality factors of the prepreg cloth.

5.2 Quality monitoring of the prepreg by NIR spectroscopy

The application of NIR spectroscopy for monitoring the production of glass/phenolic prepreg (Li et al., 2005; Li et al., 2006a; Li et al., 2008), carbon/phenolic prepreg (Li et al., 2006b) and carbon/epoxy prepreg (Jiang et al., 2007a; Jiang et al., 2007b) has been realized. In the production process of prepreg cloth with solution impregnation method, a FT-NIR spectrometer was assembled between the take-up mechanism and the drying tower, as shown in Fig. 3. (Li et al., 2006a; Li et al., 2008). The spectrometer could perform non-contact analysis of the product. In the test, the light from the sources was focused onto the prepreg cloth, and then the diffuse reflectance spectra from the prepreg cloth were recorded by the spectrometer. A gilded metal plate was placed under the prepreg cloth in order to enhance the diffuse reflectance effect.

The partial least square regression algorithm was used to build calibration models. The models of resin content, volatile content and pre-curing degree were developed respectively. The correlations between the predicted values and the actual values for the models are listed in Fig.4. (Li et al., 2006a). The models had determination coefficients (R^2) of 98.29 for the resin content, of 99.50 for the volatile content and of 97.66 for the pre-curing degree, respectively. The root mean square errors of prediction (RMSEP) for the resin content, the volatile content and the pre-curing degree were 0.376%, 0.169% and 0.105%, respectively.

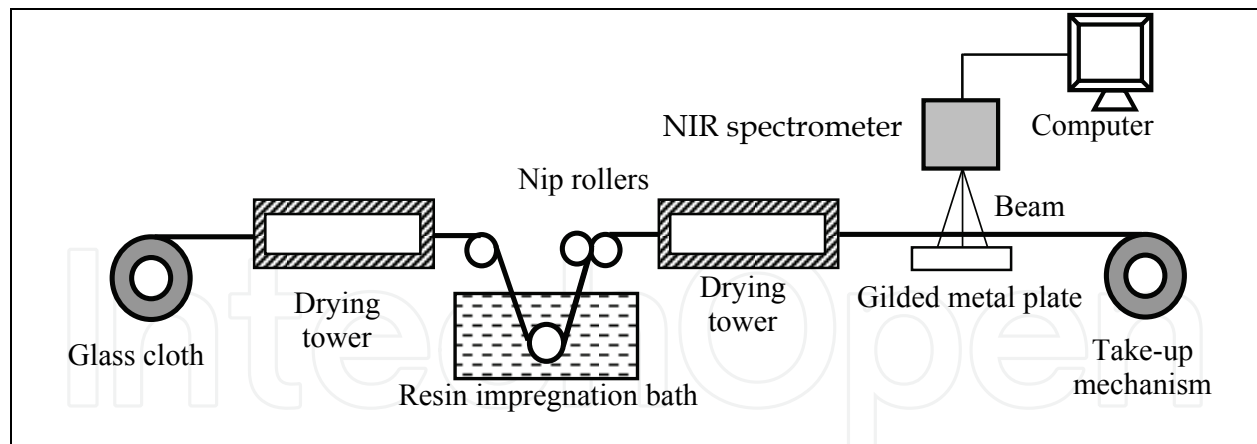

Fig. 3. Schematic of process for the manufacture of glass/phenolic prepreg cloth (Li et al. 2006a; Li et al., 2008)

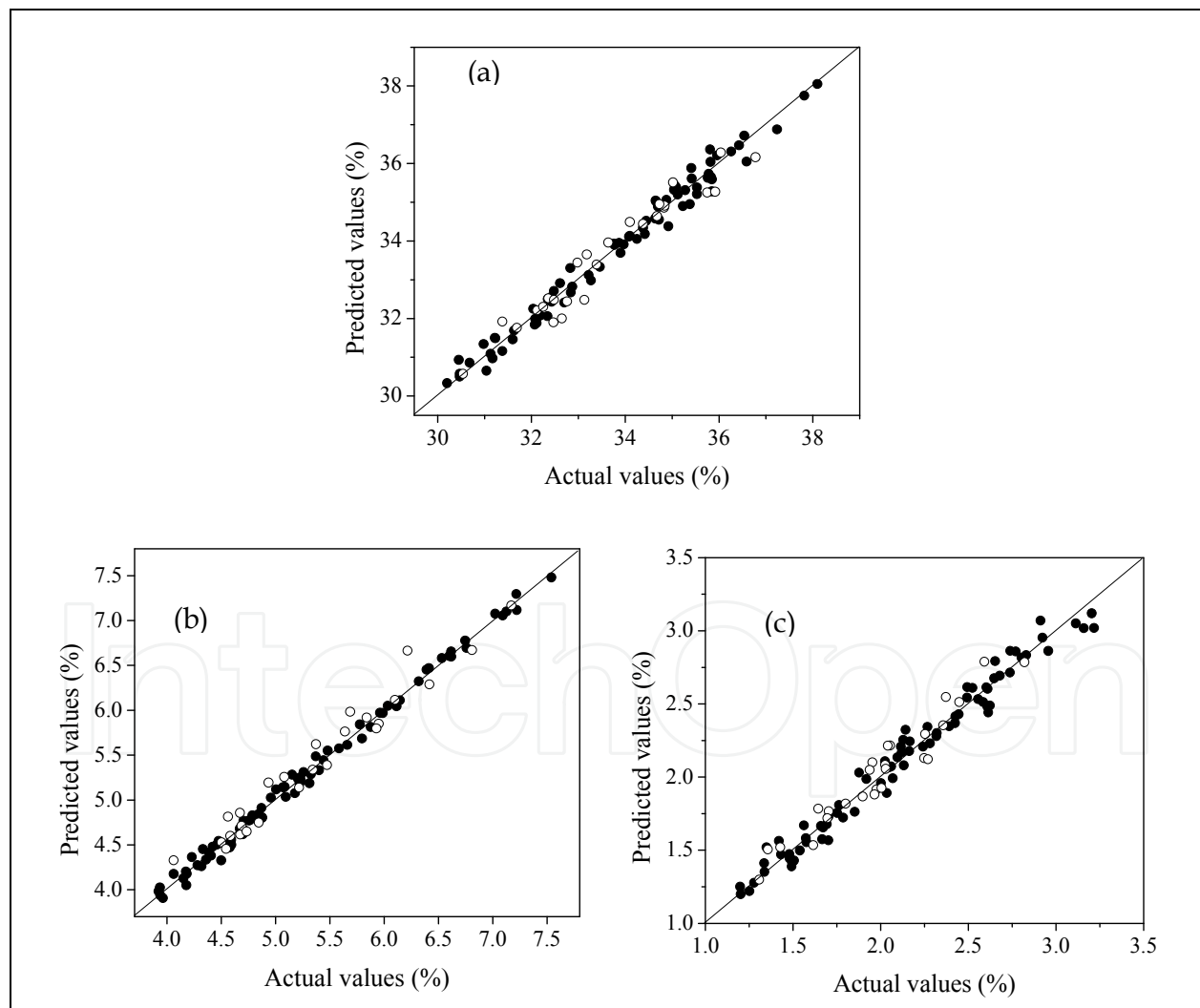

Fig. 4. Scatter plots showing correlation between chemical methods and NIR analyses for: (a) resin content; (b) volatile content; (c) pre-curing degree. Filled and open circles correspond to calibration and prediction data, respectively (Li et al. 2006a; Li et al., 2008)

In the manufacturing process, the prepreg quality is affected by processing parameters such as the concentration of resin solution, distance apart of the nip rollers, temperature of the drying tower, etc. In order to investigate the effects of processing parameters on prepreg quality, the NIR spectroscopy was used in-line for monitoring the change rules of resin content, volatile content and pre-curing degree when the processing parameters were adjusted deliberately (Li et al. 2008).

The NIR monitoring results indicated that the resin content increased with the increase of the resin concentration and the nip rollers separation. The pre-curing degree was hardly changed with these two adjustments. Meanwhile, it was also found that the volatile content increased with any increase of resin content. The reason was that the volatilisation started on the prepreg surface, the inner volatile component needed to overcome resistance when it diffused from the inner part to the surface. When there were much resin existed in the prepreg, the escape of volatile was difficult. The monitoring results also revealed that the pre-curing degree increased with the increase of the drying temperature and decreased with the increase of the production speed, and the change of volatile was opposite to that of pre-curing degree. The resin content was hardly affected by the change of drying temperature and production speed.

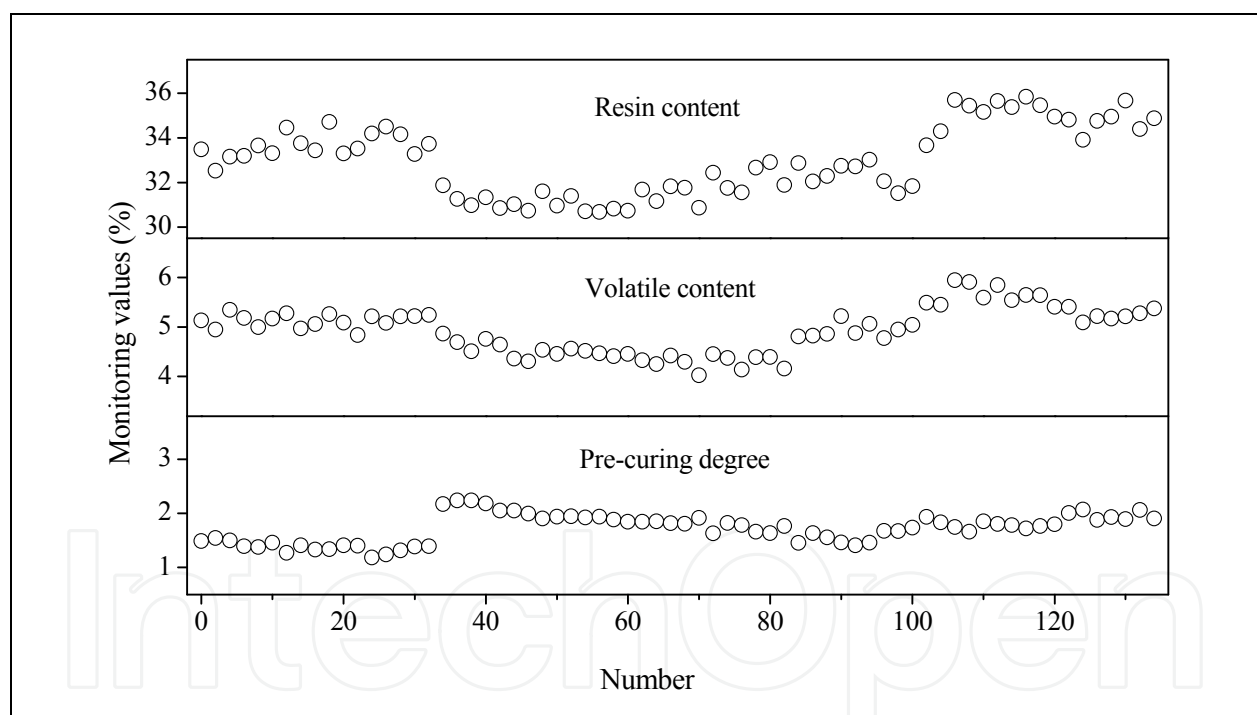

Fig. 5. Actual change of the glass/phenolic prepreg quality in the usual manufacture process (Li et al. 2008)

In the usual manufacturing process of prepreg cloth, the off-line traditional analysis method are often used to control the prepreg quality. The actual change of the prepreg quality obtained from NIR monitoring results is illustrated in Fig. 5. It was shown that the prepreg cloths with low resin contents were produced over a long period, and the range of resin contents was rather wide. Obviously, the unqualified product was probably produced due to the delayed analysis results. In order to obtain high quality products, it was necessary to adjust appropriate processing parameters real time.

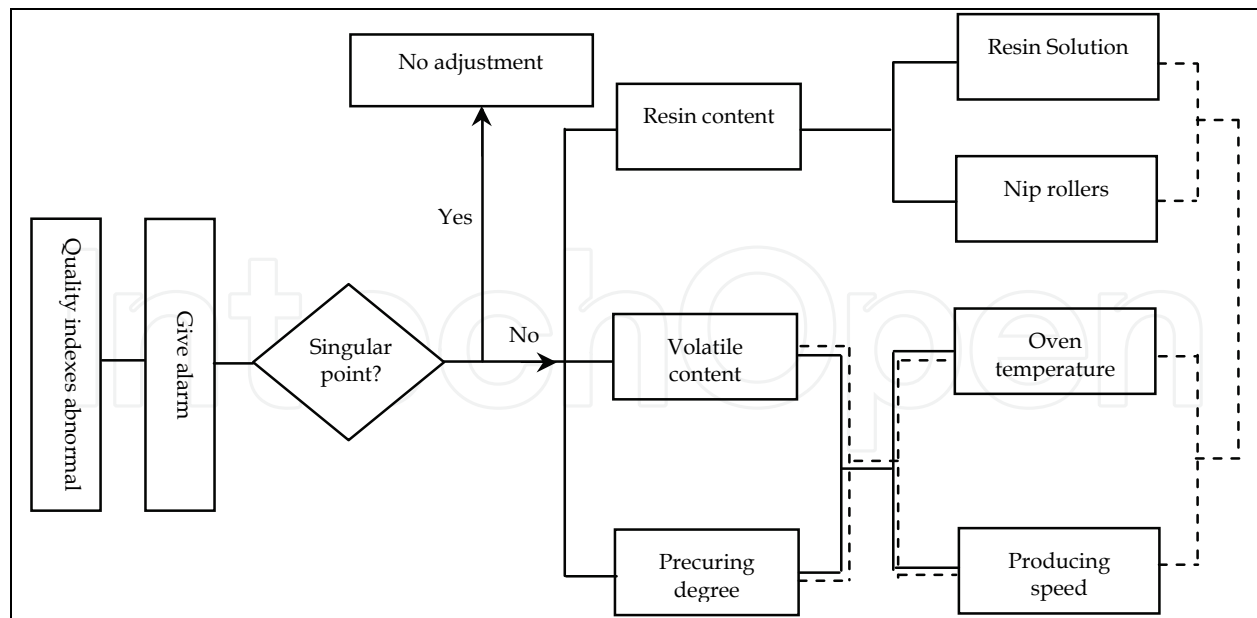

Fig. 6. Schematic of control of the prepreg quality



Fig. 7. Application of NIR for quality monitoring in the production of glass/phenolic prepreg cloth

Fig. 6 shows the schematic of control of prepreg quality. In the production process, the alarm was given when the NIR monitoring result of any quality index exceeded the preset ranges. At this moment, it was needed to judge whether adjusted the processing parameters or not according to the change tendency of prepreg quality indexes. If it was only the individual singular point which appeared accidentally, there was no need to make adjustment. Otherwise, the adjustment must be carried on the processing parameters when the running tendency of prepreg quality index was changed. In case the resin content was not existed in the normal range, the general rule was to adjust the resin concentration and

the distance between nip rollers. As for the volatile content and pre-curing degree, it was required to change the oven temperature and production speed. However, it was noted that the volatile content would be changed with the change of resin content by adjusting the resin concentration and the nip rollers separation. If the volatile content were changed too large, the adjustment of oven temperature and production speed was essential. In this case, the change of pre-curing degree would be occurred inevitably. It was apparently that the control of prepreg quality indexes was a complex process. The corresponding change of other two qualitative indexes should be monitored while one quality index was adjusted. The photograph of NIR application in the production of glass/phenolic prepreg cloth is shown in Fig. 7. Based on the NIR on-line monitoring results, the quality controlling results obtained by adjusting the processing parameters are illustrated in Fig. 8.

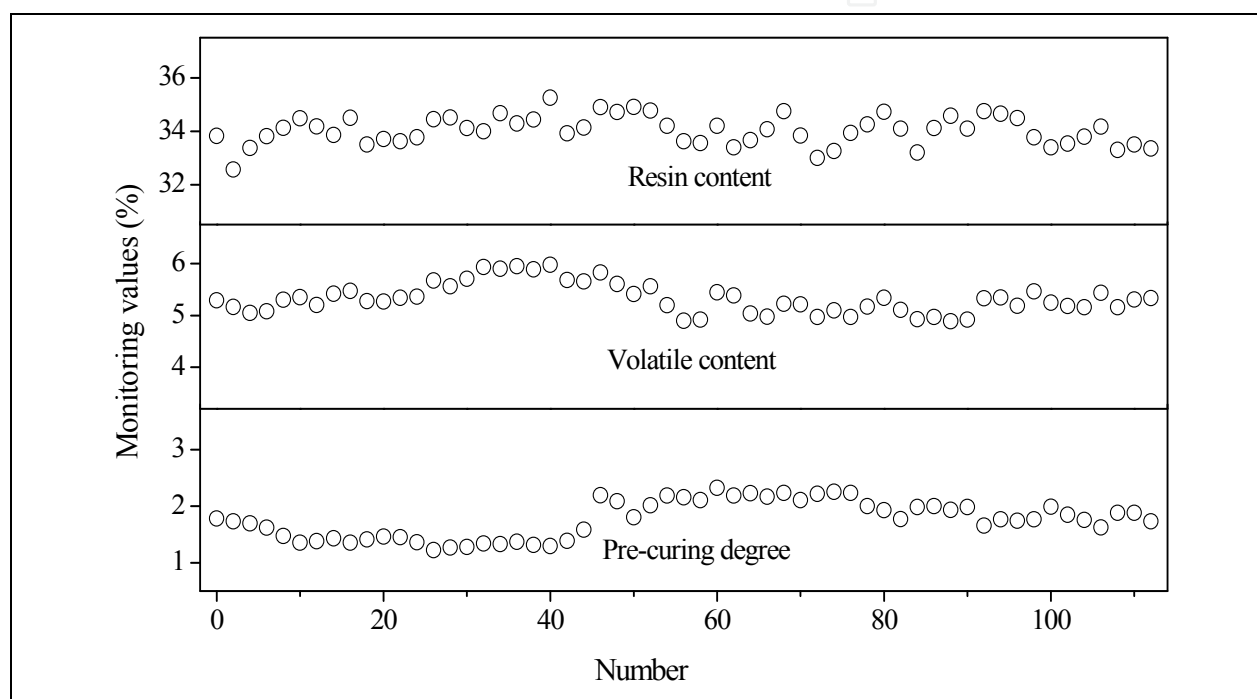

Fig. 8. Quality control of the glass/phenolic prepreg cloth by NIR method (Li et al., 2008)

From the Fig.8, it was known that the resin content, volatile content and pre-curing degree were varied within the relative narrow ranges. The results revealed that NIR spectroscopy was a suitable process monitoring technique for the production of prepreg.

6. Conclusion

Applications of the NIR technology for process monitoring of polymer systems have been summarized, which included polymerization process, extrusion process, curing process and manufacture process of prepreps. It is shown that there is a growing interest in utilization of NIRS as a tool for process monitoring in the polymer fields. The introduction of NIR technique is really helpful to improve the product quality. The polymer industry really needs rapid, reliable, non-invasive and cost effective analytical methods for process monitoring, such as NIR spectroscopy technique. Due to its intrinsic features, it is predicted that application of NIR technique in the polymer process monitoring will be become broader in the future.

7. References

- Aldridge, P. K.; Kelly, J. J.; Callis, J. B. & Burns, D. H. (1993). Noninvasive Monitoring of Bulk Polymerization using Short-Wavelength Near-Infrared Spectroscopy. *Analytical Chemistry*, Vol. 65, No.24, 3581-3585, ISSN 0003-2700
- Amy, M. L. & Jiri, K. D. (1995). Process for measurement of the degree of cure and percent resin of glass-fiber reinforced epoxy resin prepreg. *U S Patent*, 5457319
- Batra, J.; Khettry, A. & Hansen, M. G. (1994). In-Line Monitoring of Titanium Dioxide Content in Poly(Ethylene Terephthalate) Extrusion. *Polymer Engineering and Science*, Vol. 34, No. 23, 1767-1772, ISSN 0032-3888
- Butler, W. L. & Norris, K. H. (1960). The Spectrophotometry of Dense Light-Scattering Material, *Archives of Biochemistry and Biophysics*, Vol. 87, No.1, 31-40, ISSN 0003-9861
- Cherfi, A. & Fevotte, G. (2002). On-line Conversion Monitoring of the Solution Polymerization of Methyl Methacrylate using Near-Infrared Spectroscopy. *Macromolecular Chemistry and Physics*, Vol. 203, No.9, 1188-1193, ISSN 1022-1352
- Cherfi, A.; Fevotte, G. & Novat, C. (2002). Robust on-line measurement of conversion and molecular weight using NIR spectroscopy during solution polymerisation. *Journal of Applied Polymer Science*, Vol. 85, No.12, 2510-2520, ISSN 0021-8995
- Coates, P. D.; Barnes, S. E.; Sibley, M. G.; Brown, E. C.; Edwards, H. G. M. & Scowen, I. J. (2003). In-Process Vibrational Spectroscopy and Ultrasound Measurements in Polymer Melt Extrusion. *Polymer*, Vol. 44, No. 19, 5937-5949, ISSN 0032-3861
- Dannenberg, H. (1963). Determination of functional groups in epoxy resins by near-infrared spectroscopy. *Polymer Engineering and Science*, Vol. 3, No. 1, 78-88, ISSN 0032-3888
- De Faria, J. M. Jr.; Machado, F.; Lima, E. L. & Pinto, J. C. (2010a). In-Line Monitoring of Vinyl Chloride Suspension Polymerization with Near-Infrared Spectroscopy, 1-Analysis of Morphological Properties. *Macromolecular Reaction Engineering*, Vol. 4, No. 1, 11-24, ISSN 1862-832X
- De Faria, J. M. Jr.; Machado, F.; Lima, E. L. & Pinto, J. C. (2010a). In-Line Monitoring of Vinyl Chloride Suspension Polymerization with Near-Infrared Spectroscopy, 2-Design of an Advanced Control Strategy. *Macromolecular Reaction Engineering*, Vol. 4, No. 8, 486-498, ISSN 1862-832X
- Fischer, D.; Bayer, T.; Eichhorn, K.-J. & Otto, M. (1997). In-Line Process Monitoring on Polymer Melts by NIR-Spectroscopy. *Journal of Analytical Chemistry*, Vol. 359, No. 1, 74-77, ISSN 1061-9348
- Fontoura, J. M. R.; Santos, A. F.; Silva, F. M.; Lenzi, M. K.; Lima, E. L.; Pinto, J. C. (2003). Monitoring and Control of Styrene Solution Polymerization using NIR Spectroscopy. *Journal of Applied Polymer Science*, Vol.90, No. 5, 1273-1289, ISSN 0021-8995
- Goddu, R. F. & Delker, D. A. (1958). Determination of Terminal Epoxides by Near-Infrared Spectrophotometry. *Analytical Chemistry*, Vol. 30, No. 12, 2013-2016, ISSN 0003-2700
- Gossen, P. D.; MacGregor, J. F. & Pelton, R.H. (1993). Composition and particle diameter for styrene/methyl methacrylate copolymer latex using UV and NIR spectroscopy. *Applied Spectroscopy*, Vol. 47, No. 11, 1852-1870, ISSN 0003-7028
- Hansen, M. G. & Vedula, S. (1998). In-Line Fiber-Optic Near-Infrared Spectroscopy: Monitoring of Rheological Properties in an Extrusion Process. Part I. *Journal of Applied Polymer Science*, Vol. 68, No. 6, 859-872, ISSN 0021-8995

- Hopewell, J.L.; George, G.A. & Hill, D.J.T. (2000). Quantitative Analysis of Bismaleimide-Diamine Thermosets using Near Infrared Spectroscopy. *Polymer*, Vol. 41, No. 23, 8221-8229, ISSN 0032-3861
- Huang, Y. D.; Liu, L.; Zhang, Z. Q. & Wang, Y. (1997). On-line Monitoring of Resin Content for Film Impregnation Process. *Composites Science and Technology*, Vol. 58, No. 9, 1531-1534, ISSN 0266-3538
- Huang, Y. D.; Sun, Y. F. & Liu, L. (2003). Beta Ray Monitoring Technique for Control of Resin Content in Continuous Fibre Prepreg Materials. *Material Science and Technology*, Vol. 19, No. 6, 815-818, ISSN 0267-0836
- Jiang, B.; Huang, Y. D.; Li, W. & Liu, L. (2007a). Non-Contact Quality Monitoring of Laid Fabric Carbon/Epoxy Resin Prepreg using Near Infrared Spectroscopy. *Journal of Near Infrared Spectroscopy*, Vol. 15, No. 5, 299-305, ISSN 0967-0335
- Jiang, B.; Huang, Y. D.; Li, W. & Liu, L. (2007b). Non-Destructive and Rapid Analysis of Resin and Volatile Contents in Carbon Fiber/Epoxy Resin Prepreg Cloth by Near-Infrared Spectroscopy. *Iranian Polymer Journal*, Vol. 16, No. 5, 319-326, ISSN 1026-1265
- Kortaberria, G. ; Arruti, P. ; Gabilondo, N. & Mondragon, I. (2004) . Curing of an epoxy resin modified with poly(methylmethacrylate) monitored by simultaneous dielectric/ near infrared spectroscopies. *European Polymer Journal*, Vol. 40, No. 1, 129-136, ISSN 0014-3057
- Lee, K. A. & Kradjel, C. (2007). NIR Analysis of Polymers. In: *Handbook of Near-Infrared Analysis*, Burns & Ciurczak, (Ed.), 3rd Ed., 529-568, CRC Press, ISBN 978-0-8493-7393-0, New York
- Lachenal G. (1995). Dispersive and Fourier Transform Near-Infrared Spectroscopy of Polymeric Materials. *Vibrational Spectroscopy*, Vol. 9, No. 1, 93-100, ISSN 0924-2031
- Lachenal, G. & Ozaki, Y. (1999). Advantages of Near Infrared Spectroscopy for the Analysis of Polymers And Composites. *Macromolecular Symposia*, Vol. 141, No. 1, 283-292, ISSN 1022-1360
- Li, W.; Huang, Y. D.; Liu, L. & Chen, N. T. (2005). Rapid and Nondestructive Analysis of Quality of Prepreg Cloth by Near Infrared Spectroscopy. *Composites Science and Technology*, Vol. 65, No. 11-12, 1668-1674, ISSN 0266-3538
- Li, W.; Huang, Y. D.; Liu, L. & Jiang, B. (2006a). The Application of Near Infrared Spectroscopy in the Quality Control Analysis of Glass/Phenolic Resin Prepreg. *Journal of Materials Science*, Vol. 41, No. 21, 7183-7189, ISSN 0022-2461
- Li, W.; Huang, Y. D.; Liu, L. & Jiang, B. (2006b). On-Line Monitoring of Resin Content and Volatile Content in Carbon/Phenolic Resin Prepreg Cloth by Near-Infrared Spectroscopy. *Polymers and Polymer Composites*, Vol. 14, No. 5, 537-543, ISSN 0967-3911
- Li, W.; Huang, Y. D. & Chen, P. (2008). NIR Spectroscopy: A Useful Tool for Quality Control of Glass/Phenolic Prepreg Manufacture. *Polymers and Polymer Composites*, Vol. 16, No. 1, 55-62, ISSN 0967-3911
- Lousberg, H. H. A.; Boelens, H. F. M.; Le Comte, E. P.; Hoefsloot, H.C. J.; Smilde, A.K. (2002). On-Line Determination of the Conversion in A Styrene Bulk Polymerization Batch Reactor using Near-Infrared Spectroscopy. *Journal of Applied Polymer Science*, Vol. 84, No. 1, 90-98, ISSN 0021-8995

- Ma, L. G. & Campbell, M. D. (1991). An Instrument for the Destructive Determination of Fiber/Resin Ratio in Fiber-Reinforced Composite Prepreg Materials. *Proceedings of the 7th Annual ASTM/ESD Advanced Composite Materials Conference*, pp. 377-381, ISBN 0871704315, Detroit, October, 1991, ASM International, Detroit
- Mijović, J. & Andjelić, S. (1996). Study of the Mechanism and Rate of Bismaleimide Cure by Remote in-Situ Real Time Fiber Optic Near-Infrared Spectroscopy. *Macromolecules*, Vol. 29, No.1, 239-246, ISSN 0024-9297
- Mijović, J. ; Andjelić, S. & Kenny J. M. (1998). In situ Real-time Monitoring of Epoxy/ Amine Kinetics by Remote Near Infrared Spectroscopy. *Polymers for Advanced Technologies*, Vol. 7, No. 1, 1-16, ISSN 1042-7147
- Nagata, T. ; Tanigaki, M. & Ohshima, M. (2000a). On-Line NIR Sensing of CO₂ Concentration for Polymer Extrusion Foaming Processes. *Polymer Engineering and Science*, Vol.40, No.8., 1843-1849, ISSN 0032-3888
- Nagata, T. ; Ohshima, M. & Tanigaki, M. (2000b). In-Line Monitoring of Polyethylene Density using Near Infrared Spectroscopy. *Polymer Engineering and Science*, Vol. 40, No.5, 1107-1113, ISSN 0032-3888
- Nogueira, E. S.; Borges, C.P. & Pinto, J. C. (2005). In-Line Monitoring and Control of Conversion and Weight-Average Molecular Weight of Polyurethanes in Solution Step-Growth Polymerization Based on Near Infrared Spectroscopy and Torquemetry. *Macromolecular Materials and Engineering*, Vol. 290, No.4, 272-282, ISSN 1438-7492
- Norris, K.H. & Butler, W.L. (1961). Techniques for Obtaining Absorption Spectra on Intact Biological Samples. *IRE Transactions on Biomedical Electronics*, Vol. 8, No. 3, 153, ISSN 0096-1884
- Norris, K. H. (1989). Introduction, In *Near Infrared Reflectance Spectroscopy (NIRS): Analysis of Forage Quality*. 6, Martens, Shenk & Barton (Ed.), US Government Printing Office, Washington, D.C.
- Park, S. J.; Kwak, G. H.; Sumita M. & Lee J. R. (2000). Cure and Reaction Kinetics of an Anhydride-Cured Epoxy Resin Catalyzed by N-benzylpyrazinium Salts Using Near-Infrared Spectroscopy. *Polymer Engineering and Science*, Vol. 40, No. 12, 2569-2576, ISSN 0032-3888
- Reis, M. M.; Araújo, P. H. H.; Sayer, C. & Giudici R. (2004). In Situ Near-Infrared Spectroscopy for Simultaneous Monitoring of Multiple Process Variables in Emulsion Copolymerization. *Industrial and Engineering Chemistry Research*, Vol. 43, No. 23, 7243-7250, ISSN 0888-5885
- Santos, A.F.; Lima, E.L. & Pinto, J.C. (1998). In-line Evaluation of Average Particle Size in Styrene Suspension Polymerizations using Near-Infrared Spectroscopy. *Journal of Applied Polymer Science*, Vol. 70, No. 9, 1737-1745, ISSN 0021-8995
- Santos, A.F.; Lima, E.L. & Pinto, J.C. (2000). Control and Design of Average Particle Size in Styrene Suspension Polymerization using NIRS. *Journal of Applied Polymer Science*, Vol. 77, No. 2, 453-462, ISSN 0021-8995
- Schultz, T.P.; Burns, D.A. (1990). Rapid Secondary Analysis of Lignocellulose: Comparison of Near Infrared (NIR) and Fourier Transform Infrared (FTIR). *Tappi Journal*, Vol. 73, No. 5, 209-212, ISSN 0734-1415
- Smith, D. R. Jr.; Monson, J.; Reynolds, B. & Johnsen, R. (1990). An Evaluation of an Ultrasonic Technique for Measuring Resin Content in Prepreg Material. *22nd*

- International SAMPE Technical Conference*, pp. 237-250, ISBN 0938994549, Boston, November, 1990, Society for the Advancement of Material and Process Engineering, Boston
- Smithgall, F. B. (1990). Automatic Inspection of Advanced Composite Tape, *35th International SAMPE Symposium and Exhibition*, pp. 1880-1891, ISBN 0938994522, Anaheim, April, 1990, Society for the Advancement of Material and Process Engineering, Anaheim
- Teagle, P. R. (1983). The quality control and non-destructive evaluation of composite aerospace components. *Composites*, Vol. 14, No. 2., 115-128, ISSN 0010-4361
- Rohe, T.; Becker, W.; Kölle, S.; Eisenreich, N. & Eyerer, P. (1999). Near Infrared (NIR) Spectroscopy for In-Line Monitoring of Polymer Extrusion Processes. *Talanta*, Vol. 50, No. 2, 283-290, ISSN 0039-9140
- Rohe, T.; Becker, W.; Krey, A.; Nägele, H., Kölle, S. & Eisenreich, N. (1998). In-line monitoring of polymer extrusion processes by NIR spectroscopy. *Journal of Near Infrared Spectroscopy*, Vol. 6, No. 1, 325-332, ISSN 0967-0335
- Vedula, S. & Hansen, M. G. (1998). In-Line Fiber-Optic Near-Infrared Spectroscopy: Monitoring of Rheological Properties in an Extrusion Process. Part II. *Journal of Applied Polymer Science*, Vol. 68, No. 6, 873-889, ISSN 0021-8995
- Vieira, R. A. M.; Sayer, C.; Lima, E. L. & Pinto, J. C (2001). Detection of monomer droplets in a polymer latex by near-infrared spectroscopy. *Polymer*, Vol. 42, No. 21, 8901-8906, ISSN 0032-3861
- Vieira, R.A.M.; Sayer, C.; Lima, E.L. & Pinto, J.C. (2002a). In-line and In-situ Monitoring of Semi-Batch Emulsion Copolymerizations using Near-infrared Spectroscopy. *Journal of Applied Polymer Science*, Vol. 84, No. 14, 2670-2682, ISSN 0021-8995
- Vieira, R.A.M.; Sayer, C.; Lima, E.L. & Pinto, J.C. (2002b). Closed-loop Composition and Molecular Weight Control of A Copolymer Latex using Near-infrared Spectroscopy. *Industrial and Engineering Chemistry Research*, Vol. 41, No.12, 2915 - 2930. ISSN:0888-5885
- Xu L.; Fu J. H. & Schlup J. R. (1994). In Situ Near-Infrared Spectroscopic Investigation of Epoxy Resin-Aromatic Amine Cure Mechanisms. *Journal of American Chemical Society*, Vol. 116, No. 7, 2821-2826, ISSN 0002-7863

IntechOpen



Applications and Experiences of Quality Control

Edited by Prof. Ognyan Ivanov

ISBN 978-953-307-236-4

Hard cover, 704 pages

Publisher InTech

Published online 26, April, 2011

Published in print edition April, 2011

The rich palette of topics set out in this book provides a sufficiently broad overview of the developments in the field of quality control. By providing detailed information on various aspects of quality control, this book can serve as a basis for starting interdisciplinary cooperation, which has increasingly become an integral part of scientific and applied research.

How to reference

In order to correctly reference this scholarly work, feel free to copy and paste the following:

Wei Li (2011). Process Monitoring of Polymer Systems by using Near-Infrared Spectroscopy, Applications and Experiences of Quality Control, Prof. Ognyan Ivanov (Ed.), ISBN: 978-953-307-236-4, InTech, Available from: <http://www.intechopen.com/books/applications-and-experiences-of-quality-control/process-monitoring-of-polymer-systems-by-using-near-infrared-spectroscopy>

INTECH
open science | open minds

InTech Europe

University Campus STeP Ri
Slavka Krautzeka 83/A
51000 Rijeka, Croatia
Phone: +385 (51) 770 447
Fax: +385 (51) 686 166
www.intechopen.com

InTech China

Unit 405, Office Block, Hotel Equatorial Shanghai
No.65, Yan An Road (West), Shanghai, 200040, China
中国上海市延安西路65号上海国际贵都大饭店办公楼405单元
Phone: +86-21-62489820
Fax: +86-21-62489821

© 2011 The Author(s). Licensee IntechOpen. This chapter is distributed under the terms of the [Creative Commons Attribution-NonCommercial-ShareAlike-3.0 License](#), which permits use, distribution and reproduction for non-commercial purposes, provided the original is properly cited and derivative works building on this content are distributed under the same license.

IntechOpen

IntechOpen