

We are IntechOpen, the world's leading publisher of Open Access books Built by scientists, for scientists

4,800

Open access books available

122,000

International authors and editors

135M

Downloads

Our authors are among the

154

Countries delivered to

TOP 1%

most cited scientists

12.2%

Contributors from top 500 universities



WEB OF SCIENCE™

Selection of our books indexed in the Book Citation Index
in Web of Science™ Core Collection (BKCI)

Interested in publishing with us?
Contact book.department@intechopen.com

Numbers displayed above are based on latest data collected.

For more information visit www.intechopen.com



Adaptive Neuro-Fuzzy Inference System Prediction of Calorific Value Based on the Analysis of U.S. Coals

F. Rafezi, E. Jorjani and Sh. Karimi
Science and Research Branch, Islamic Azad University, Tehran Iran

1. Introduction

Coal is a chemically and physically heterogeneous and combustible substance that consists of both organic and inorganic compounds. It currently is a major energy source worldwide, especially among many developing countries, and will continue to be so for many years (Miller, 2005). The chemical analysis of coal includes proximate and ultimate analyses. The proximate analysis gives the relative amounts of moisture, volatile matter, and ash, as well as the fixed carbon content of the coal. The ultimate or elemental analysis gives the amounts of carbon, hydrogen, nitrogen, sulfur, and oxygen in the coal (Miller, 2005).

The measure of the amount of energy that a given quantity of coal will produce when burned is known as calorific value or heating value. Heating value is a rank parameter and a complex function of the elemental composition of the coal, but it is also dependent on the maceral and mineral composition (Hower and Eble, 1996). It can be determined experimentally using a calorimeter.

Many equations have been developed for the estimation of gross calorific value (GCV) based on proximate analysis and/or ultimate analysis (Mason and Gandhi, 1983; Mesroghli et al., 2009; Given et al., 1986; Parikh et al., 2005; Custer, 1951; Spooner, 1951; Mazumdar, 1954; Channiwala and Parikh, 2002; Majumder et al., 2008).

Regression analyses and data for 775 U.S. coal samples (with less than 30% dry ash) were used by Mason and Gandhi (1983) to develop an empirical equation that estimates the calorific value (CV) of coal based on its C, H, S, and ash contents (all on dry basis). Their empirical equation, expressed in SI units, is:

$$CV = 0.472C + 1.48H + 0.193S + 0.107A - 12.29 \text{ (MJ/kg)} \quad (1)$$

Given et al. (1986) developed an equation to calculate the calorific value of U.S. coals from their elemental composition; expressed in SI units, their equation is:

$$CV = 0.3278C + 1.419H + 0.09257S - 0.1379O + 0.637 \text{ (MJ/Kg)} \quad (2)$$

Neural networks, as a new mathematical method, have been used extensively in research areas related to industrial processes (Zhenyu and Yongmo, 1996; Jorjani et al., 2007; Specht,

1991; Chen et al., 1991; Wasserman, 1993; Chehreh Chelgani et al., 2008; Hansen and Meservy, 1996; Patel et al., 2007; Mesroghli et al., 2009; Bagherieh et al., 2008; Jorjani et al., 2008; Chehreh Chelgani et al., 2010; Khandelwal and Singh, 2010; Sahu et al., 2010; Yao et al., 2005; Patel et al., 2007; Salehfar and Benson, 1998; Wu et al., 2008; Karacan, 2007).

Patel et al. (2007) predicted the GCV of coal utilizing 79 sets of data using neural network analyses based on proximate analysis, ultimate analysis, and the density of helium. They found that the input set of moisture, ash, volatile matter, fixed carbon, carbon, hydrogen, sulfur, and nitrogen yielded the best prediction and generalization accuracy.

Mesroghli et al. (2009) investigated the relationships of ultimate analysis and proximate analysis with GCV of U.S. coal samples by regression analysis and artificial neural network methods. The input set of C, $H_{\text{exclusive of moisture}} (H_{\text{ex}})$, N, $O_{\text{exclusive of moisture}} (O_{\text{ex}})$, S, moisture, and ash was found to be the best predictor.

The adaptive neuro-fuzzy inference system (ANFIS), which consists of both artificial neural networks and fuzzy logic, has been used widely in research areas related to industrial processes (Boyacioglu and Avci, 2010; Esen and Inalli, 2010; Soltani et al., 2010; Pena et al., 2010; Chong-lin et al., 2009).

The aim of the present work is to assess the properties of 4540 samples of U.S. coal from 25 states with reference to the GCV and possible variations with respect to ultimate and proximate analyses using multi-variable regression, the SPSS software package, and the ANFIS, MATLAB software package.

This work is an attempt to answer the following important questions:

- Is it possible to generate precise linear or non-linear equations between ultimate and proximate analysis parameters and GCV for different U.S. coal samples that have a wide range of calorific values from 4.82 to 34.85 MJ/kg?
- Is ANFIS a better tool than regression analysis for improving accuracy and decreasing errors in the estimation of the calorific value of coal?
- Is it possible to improve the accuracy of predictions by changing "total hydrogen and oxygen in coal (H and O)" to " H_{ex} , O_{ex} , and moisture?"

This work is different from previously published work because it involves the first use of ANFIS to predict the GCV of coal.

2. Experimental data

The data that were used to examine the proposed approaches were obtained from the U.S. Geological Survey Coal Quality (COALQUAL) database, open file report 97-134 (Bragg et al., 2009). Samples with more than 50% ash and samples that had a proximate analysis and/or an ultimate analysis different from 100% were excluded from the database.

Analysis results for a total of 4540 coal samples were used.

The sampling procedures and chemical analytical methods are available at the following website: <http://energy.er.usgs.gov/products/databases/CoalQual/index.htm>. The number of samples and the range of GCV for different states are shown in Table 1.

Table 2 shows the ranges of input variables, i.e., C, H, H_{ex} , N, O, O_{ex} , total sulfur, ash, moisture, and volatile matter, that were used in predicting GCV.

State	Number of samples	Range of GCV (MJ/kg)
Alabama	679	6.05-34.80
Alaska	51	8.65-27.42
Arizona	10	18.54-24.36
Arkansas	52	5.57-34.68
Colorado	172	7.24-33.81
Georgia	25	24.03-34.85
Indiana	101	19.23-28.96
Iowa	73	16.03-26.59
Kansas	19	20.87-28.86
Kentucky	720	18.68-34.03
Maryland	40	23.04-33.48
Missouri	68	23.83-28.63
Montana	140	5.55-20.63
New Mexico	114	8.81-32.15
North Dakota	124	4.85-13.61
Ohio	398	16.43-31.14
Oklahoma	25	23.89-33.31
Pennsylvania	498	13.58-33.10
Tennessee	42	24.61-33.48
Texas	33	9.54-27.74
Utah	103	4.82-30.14
Virginia	368	19.49-34.80
Washington	10	13.14-27.45
West Virginia	340	14.29-34.75
Wyoming	335	6.27-34.23

Table 1. Number of samples and range of GCV (as-received) for different U.S. states

Variable (%)	Minimum	Maximum	Mean	Std. Deviation
Moisture	0.4	49.60	8.90	9.90
Volatile matter	3.80	55.70	32.30	6.32
Ash	0.90	32.90	10.84	5.97
Hydrogen	1.70	8.10	5.27	0.69
Carbon	24.10	89.60	65.72	12.02
Nitrogen	0.20	2.41	1.29	0.33
Oxygen	0.90	54.70	14.86	11.27
Sulfur	0.07	17.30	1.90	1.73
H _{ex}	0.19	5.86	4.36	0.79
O _{ex}	0.09	22.14	7.50	3.27

Table 2. Ranges of proximate and ultimate analyses of coal samples (as-received)

3. Methods

3.1 Regression analysis

Regression analysis is a statistical tool that is used to investigate the relationships between variables. Usually, the investigator seeks to ascertain the causal effect of one variable upon another. To explore such issues, the investigator assembles data on the underlying variables of interest and employs regression analysis to estimate the quantitative effect of the causal variables upon the variable that they influence. The investigator also typically assesses the statistical significance of the estimated relationships, that is, the degree of confidence that the true relationship is close to the estimated relationship (An introduction to regression analysis, Alan O. Sykes).

Linear regression estimates the coefficients of the linear equation, involving one or more independent variables, which are required to have a reliable prediction of the value of the dependent variable. All variables must pass the tolerance criterion to be entered in the equation, regardless of the entry method specified. The default tolerance level is 0.0001. Also, a variable is not entered if it would cause the tolerance of another variable already in the model to drop below the tolerance criterion. All independent variables selected are added to a single regression model. However, different entry methods can be specified for different subsets of variables. Method selection allows specifying how independent variables will be entered into the analysis. Using different methods, a variety of regression models can be selected from the same set of variables (SPSS Inc., 2004).

Non-linear regression is a method of finding a non-linear model of the relationship between the dependent variable and a set of independent variables. Unlike traditional linear regression, which is restricted to estimating linear models, non-linear regression can estimate models with arbitrary relationships between independent and dependent variables. This is accomplished using iterative estimation algorithms (SPSS Inc., 2004).

In this study, both single-variable and multi-variable regressions were used to develop correlations between ultimate and proximate analyses of coal samples with their gross calorific value (GCV). A stepwise procedure for selecting variables was used, and the variables were entered sequentially into the model. The first variable considered for use in the equation was the one with the largest positive or negative correlation with the dependent variable. This variable was entered into the equation only if it satisfied the criterion for entry. The next variable, with the largest partial correlation, was considered as the second input to the equation. The procedure stops when there are no variables that meet the entry criterion (SPSS Inc., 2004).

3.2 Adaptive neuro fuzzy inference system

In the artificial intelligence field, the term “neuro-fuzzy” refers to combinations of artificial neural networks and fuzzy logic. Fuzzy modeling and neural networks have been recognized as powerful tools that can facilitate the effective development of models and integrate information from different sources, such as empirical models, physical laws, or measurements and heuristics (Babuska, 1998); these two tools were combined in order to achieve readability and learning ability at the same time (Jantzen, 1998). The neuro-fuzzy approach in the fuzzy modeling research field is divided into two areas: 1) linguistic fuzzy modeling that is focused on interpretability, mainly the Mamdani model and 2) precise fuzzy modeling that is focused on accuracy, mainly the Takagi-Sugeno-Kang (TSK) model (Wikimedia Foundation Inc., 2009). ANFIS is an architecture that is functionally equivalent to a Takagi-Sugeno-Kang-type fuzzy

rule base (Jang & Sun, 1995); it is a class of adaptive, multi-layer, feed-forward networks that is functionally equivalent to a fuzzy inference system.

A fuzzy rule in a Sugeno fuzzy model has the form of:

$$\text{If } x \text{ is } A \text{ and } y \text{ is } B \text{ then } z = f(x, y) , \tag{3}$$

where A and B are input fuzzy sets in the antecedent, and, usually, $z = f(x, y)$ is a zero- or first-order polynomial function in the consequent. The fuzzy reasoning procedure for the first-order Sugeno fuzzy model and equivalent ANFIS structure is shown in Fig. 1.

Here, the defuzzification procedure in the Mamdani fuzzy model is replaced by the operation of the weighted average in order to avoid the time-consuming procedure of defuzzification. Defuzzification refers to the way a crisp value is extracted from a fuzzy set as a representative value (Jang and Sun, 1995).

Jang and Sun (1995) and Jantzen (1998) have provided more details about the ANFIS architecture, learning algorithms, and training methods.

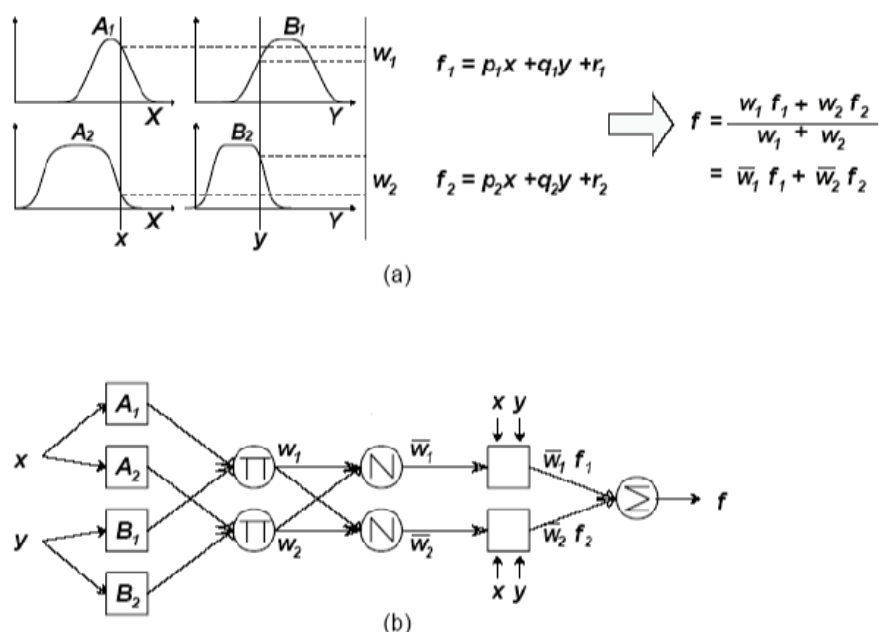

Fig. 1. (a) The Sugeno fuzzy model reasoning; (b) equivalent ANFIS structure (Jang and Sun, 1995)

4. Results and discussion

4.1 Relationships between GCV and individual input variables

By a least squares mathematical method, the correlation coefficients (R^2) of C, H, H_{ex} , N, O, O_{ex} , total sulfur, ash, moisture, and volatile matter with GCV were determined to be +0.99, -0.25, +0.72, +0.52, -0.86, -0.51, +0.01, -0.05, -0.85, and +0.03, respectively. From the above-mentioned results, it can be concluded that the worthy relationships are for carbon with positive effect and oxygen with negative effect, because they are rank parameters; and moisture with negative effect, because it is also a rank parameter at low rank coals and because it is a diluent with respect to heating value. Non-linear relationships between individual input variables and GCV were examined as well, but the results were not better than the results obtained when the linear procedure was used.

4.2 Multi-variable relationships of GCV with ultimate and proximate analysis parameters

The best-correlated linear equations, using a stepwise procedure between the various mentioned parameters and GCV, can be presented as follows:

- a. Ash, moisture, and volatile matter inputs:

$$\text{GCV (MJ/kg)} = 37.777 - 0.647M - 0.387A - 0.089VM \quad R^2 = 0.97 \quad (4)$$

- b. Carbon, hydrogen, nitrogen, oxygen, sulfur, and ash inputs:

$$\text{GCV (MJ/kg)} = 5.833 + 0.284C - 0.321O + 1.031H + 0.519N - 0.046\text{Ash} \\ R^2 = 0.994 \quad (5)$$

- c. Carbon, hydrogen exclusive of moisture, nitrogen, oxygen exclusive of moisture, sulfur, moisture, and ash inputs:

$$\text{GCV (MJ/kg)} = 26.452 + 0.074C - 0.405M + 0.89H_{\text{ex}} - 0.446 O_{\text{ex}} - 0.256\text{Ash} - 0.195S \\ R^2 = 0.995 \quad (6)$$

Estimated deviations of GCV from target values for equations (4) through (6) are shown in Table 3.

GCV deviation from target (MJ/kg)	Eq. (4)	Eq. (5)	Eq. (6)
Less than 0.5	39.4%	71.7%	78.2%
Less than 1	72.5%	95.2%	96.5%
More than 1	27.2%	4.8%	3.5%

Table 3. Estimated deviations of GVC from target values for various linear regression equations

The non-linear equations were examined as well, and the exponential equation was the best predictor of GCV. The results for the input sets of (a), (b), and (c) are shown in the following equations:

- a. Ash, moisture, and volatile matter inputs:

$$\text{GCV} = 182.667 + 37.564e^{-0.027M} - 0.381e^{0.042VM} - 182.79e^{0.002A} \quad R^2 = 0.988 \quad (7)$$

- b. Carbon, hydrogen, nitrogen, oxygen, sulfur, and ash inputs:

$$\text{GCV} = -156.641 - 0.091e^{-0.073A} + 60.15e^{0.004C} - 13.95e^{-0.322H} + 0.33e^{0.648N} + 109.885e^{-0.003O} - 0.318e^{-0.363S} \\ R^2 = 0.995 \quad (8)$$

- c. Carbon, hydrogen exclusive of moisture, nitrogen, oxygen exclusive of moisture, sulfur, moisture, and ash inputs:

$$\text{GCV} = -278.474 + 4.487e^{0.016C} + 24.485e^{-0.019M} + 7.173e^{0.013N} + 76.532e^{0.012Hex} + \\ 189.349e^{-0.001Oex} - 0.033e^{0.221S} - 4.727e^{0.021A} \quad R^2 = 0.999 \quad (9)$$

The estimation of GCV deviations from target values for equations (7) through (9) are shown in Table 4. By comparing Tables 3 and 4, it can be concluded that exponential equations are more precise than linear equations for predicting the GCV of coal.

GCV deviation from target (MJ/kg)	Eq. (7)	Eq. (8)	Eq. (9)
Less than 0.5	60%	28.98%	74.8%
Less than 1	86.65%	71.34%	99.1%
More than 1	13.35%	28.66%	0.9%

Table 4. Estimation of the deviations of GCV from target values for various non-linear regression equations

4.3 ANFIS prediction

Three input sets, (a), (b) and (c), were used to determine whether ANFIS is able to predict GCV better than regression. This was done using the ANFIS menu in the MATLAB software package to identify the relationships between GCV and input variables.

In a neuro-fuzzy inference system, the first step is to determine the system inputs and outputs that will be used to predict GCV. In this study, input set (a) was comprised of three variables, i.e., ash, volatile matter, and moisture; input set (b) was comprised of six variables, i.e., C, H, N, O, S, and ash; input set (c) was comprised of seven variables, i.e., C, H_{ex}, N, O_{ex}, S, ash, and moisture.

The Sugeno fuzzy inference system was used in this research. The output functions in the Sugeno system are linear or constant. A rule in the fuzzy Sugeno model is:

$$\text{If input 1} = x \text{ and input 2} = y, \text{ then the output is } z = ax + by + c \quad (10)$$

In the Sugeno system, for a zero-order model, the z plane is constant ($a = b = 0$). The plane of z_i , the output of any rule, is weighted by w_i . The final output of the system is the weighted average of all outputs, which is calculated as follows:

$$\text{final output} = \frac{\sum_{i=1}^N w_i z_i}{\sum_{i=1}^N w_i} \quad (11)$$

The subtractive clustering scheme was used to cluster data; the best-designed, neuro-fuzzy system for input sets (a), (b), and (c) were systems with three, five, and twelve clusters, respectively. For input set (a), the range of influence, squash factor, accept ratio, and reject ratio were selected as 0.5, 1.25, 0.5, and 0.15, respectively; for input set (b), they were 0.35, 1.25, 0.5, and 0.15, respectively; and, for input set (c), they were 0.25, 1.2, 0.5, and 0.125, respectively. The Gaussian membership function was used. For training of the ANFIS, the hybrid method was used with 3200 sets of data; the remaining 1340 sets of data were used

Model	Basis	Model inputs	Training set size	Testing set size	Number of membership functions	R ²
a	As received	Ash, volatile matter, moisture	3200	1340	3	0.997
b	As received	C, H, N, O, S, ash	3200	1340	5	0.999
c	As received	C, H _{ex} , N, O _{ex} , S, ash, moisture	3200	1340	12	0.999

Table 5. Details of the best-correlated neuro-fuzzy models

for testing. For the training stage, we selected 100 epochs. Details of the best-correlated neuro-fuzzy models are shown in Table 5. As Table 5 shows, the designed neuro-fuzzy systems can predict the GCV with acceptable correlation coefficients (R^2) of 0.997, 0.999, and 0.999 for the (a), (b), and (c) input sets, respectively.

As an example, the neuro-fuzzy design structure for model (c) to predict GCV is shown in Fig. 2.

The estimates of the deviations of the GCV from target values produced by the neuro-fuzzy models are shown in Table 6. It can be seen that the prediction precision of GCV from ANFIS and using all three input sets (a), (b), and (c) (Table 6) are better than those from linear and non-linear regression (Tables 3 and 4).

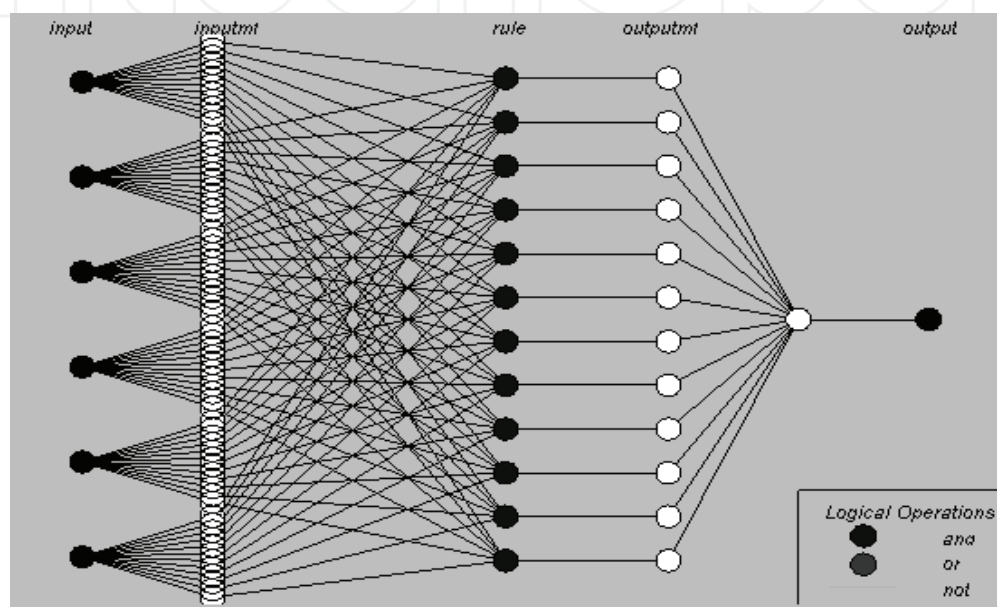

Fig. 2. ANFIS model structure for the prediction of GCV using input set (c)

GCV deviation from target (MJ/kg)	Model a (3-member function)	Model b (5-member function)	Model c (12-member function)
Less than 0.5	83%	97.6%	99.4%
Less than 1	99.4%	100%	100%
More than 1	0.5%	0%	0%

Table 6. Estimation of deviations of GCV from target values for neuro-fuzzy models

The GCV predicted (GCV_P) by ANFIS in the testing stage for input sets (a), (b), and (c) compared to the actual values determined in the laboratory (GCV_a) are shown in Figs. 3, 4, and 5, respectively. The distributions of the differences between actual and estimated GCVs are shown in Figs. 6, 7, and 8 for input sets (a), (b), and (c), respectively.

5. Technical considerations

According to Eqs. (4) through (9) and the results presented in Tables 3 and 4, it can be seen that the exponential equations are better than linear equations for predicting GCV; among the exponential equations, Eq (9) is the most suitable equation. A correlation coefficient of 0.999 and a deviation from experimentally calculated GCVs that was only 0.9 % more than

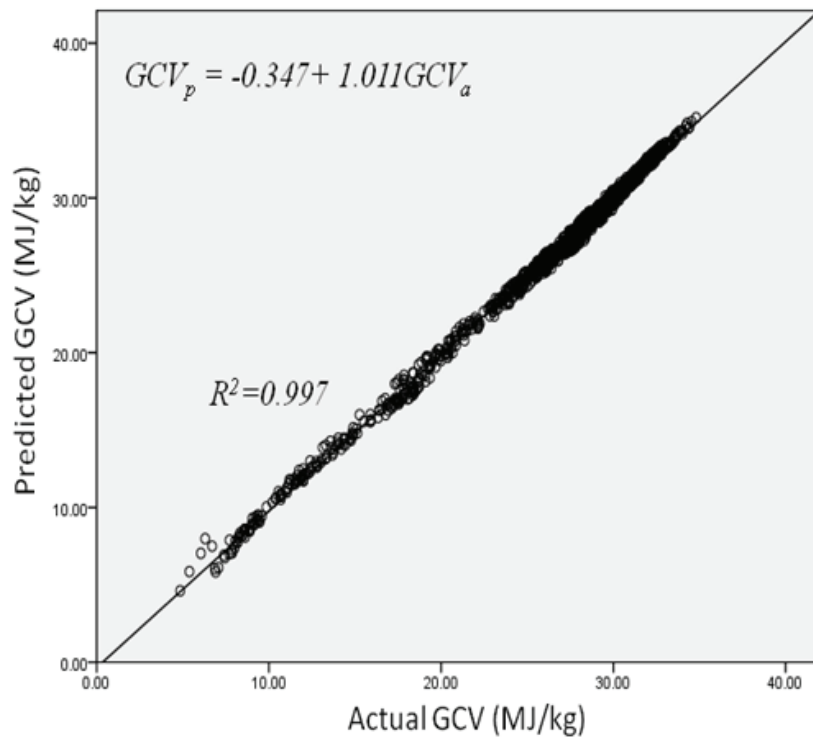

Fig. 3. ANFIS-estimated GCV in testing stage versus actual determined value (model a)

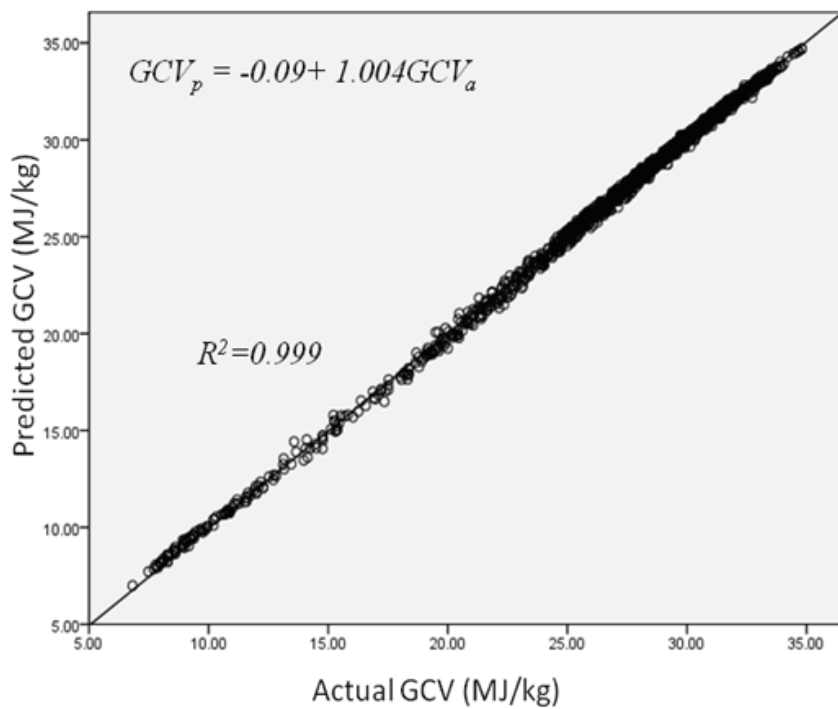

Fig. 4. ANFIS-estimated GCV in testing stage versus actual determined value (model b)

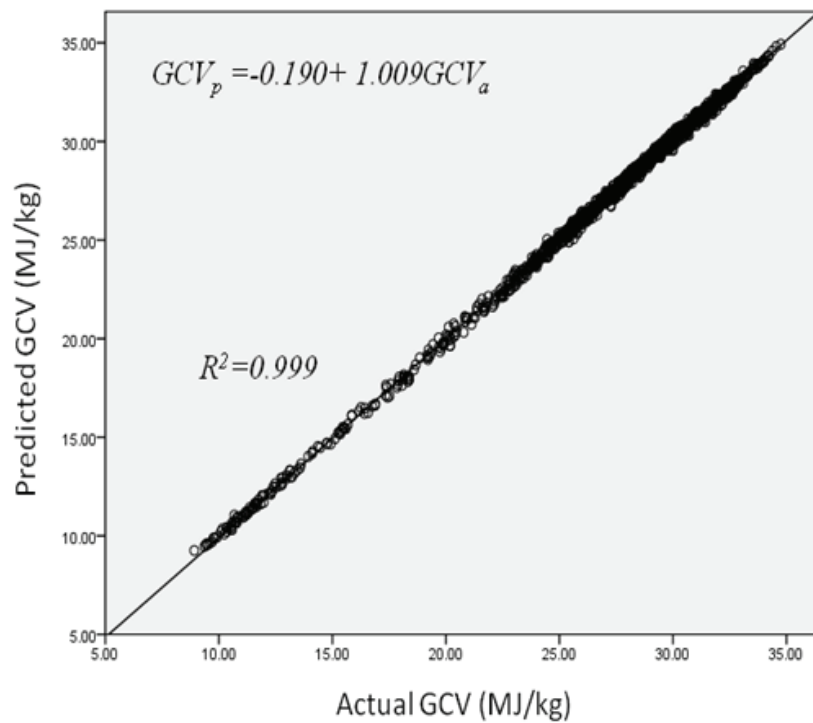

Fig. 5. ANFIS-estimated GCV in testing stage versus actual determined value (model c)

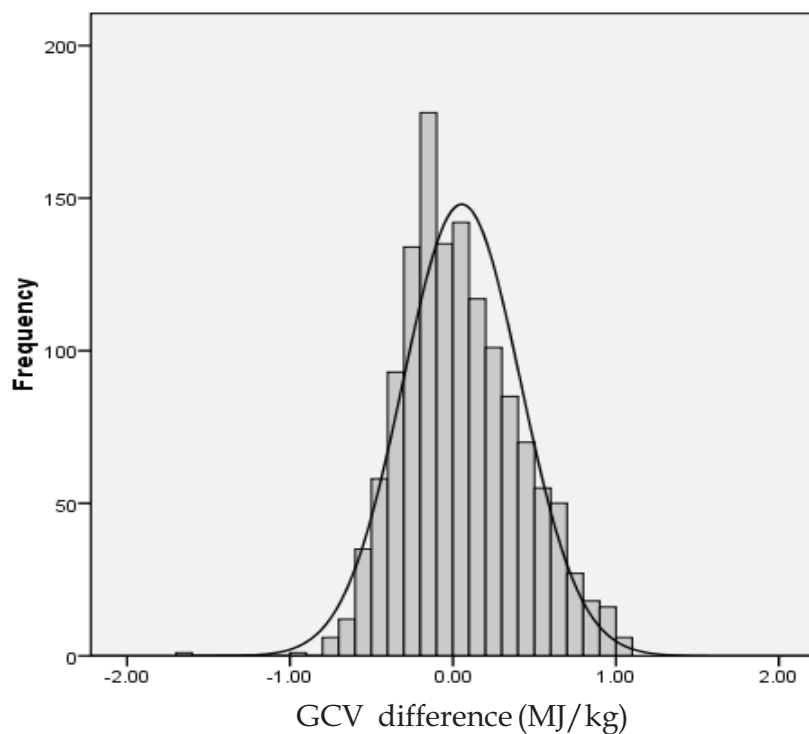

Fig. 6. Distribution of difference between actual and estimated GCV in testing stage (model a)

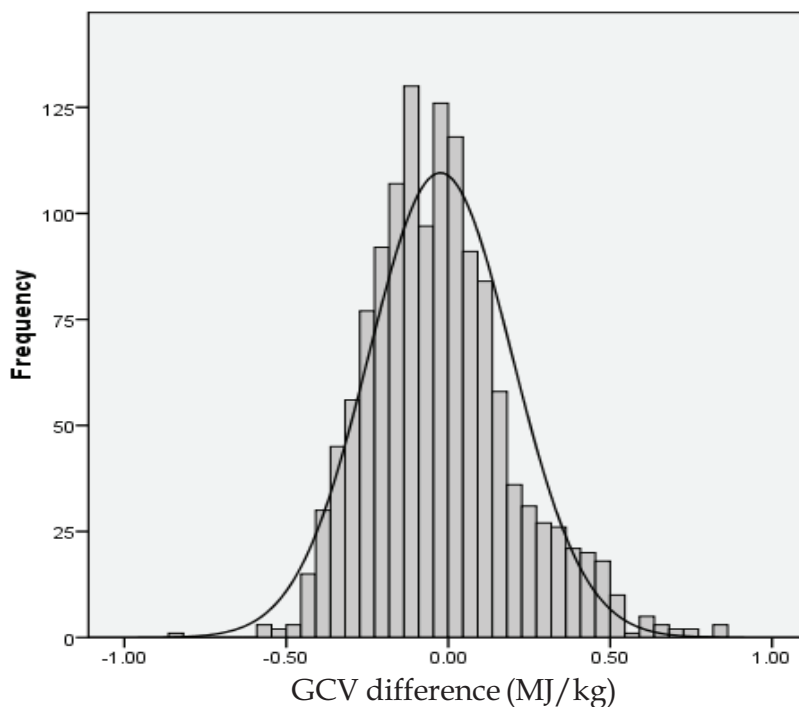

Fig. 7. Distribution of difference between actual and estimated GCV in testing stage (model b)

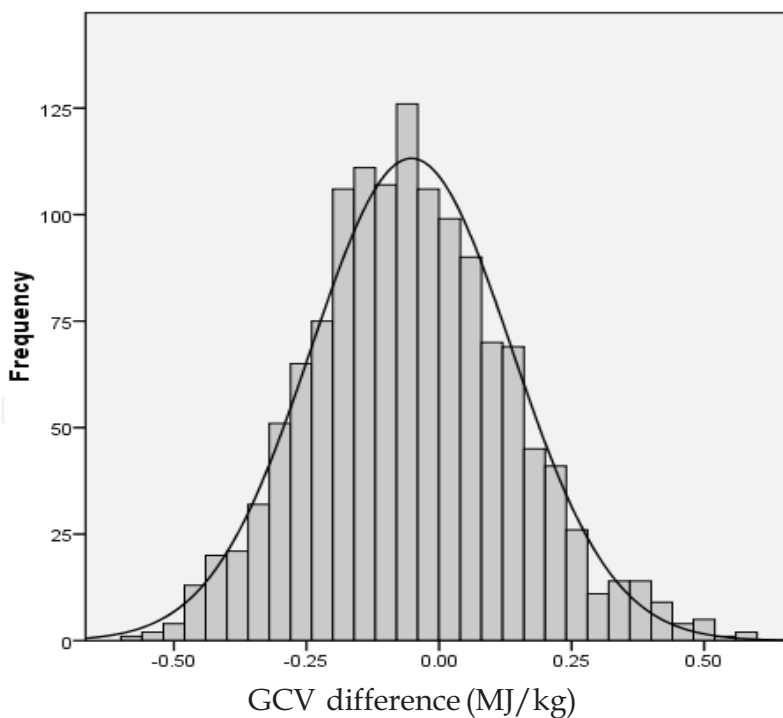

Fig. 8. Distribution of difference between actual and estimated GCV in testing stage (model c)
0.5 (MJ/kg) were achieved by Eq (9). With reference to the above results, it can be concluded that the input set of carbon, hydrogen exclusive of moisture, nitrogen, oxygen exclusive of moisture, sulfur, moisture, and ash can be used as the best and most-reliable input for the

prediction of the GCV of coal using exponential equations. Restating “hydrogen and oxygen” in the form of “hydrogen exclusive of moisture, oxygen exclusive of moisture, and moisture” can decrease the errors and deviations from experimentally calculated GCV by regression. According to Table 5, which presents the correlation coefficients of the ANFIS models for the (a), (b), and (c) input sets, the correlation coefficients in the test stage were determined to be 0.997 (model a) to 0.999 (models b and c). In addition, Table 6, which presents the deviations of the ANFIS model predictions from target values, shows that the errors and deviations from experimentally calculated GCVs in ANFIS models are less than those produced by regression models. Although Mesroghli et al. (2009) reported that artificial neural network is not better or very different from regression results when the proximate and ultimate analyses are the GCV predictors. However, in the current work, a suitable, structured ANFIS model predicted GCV with a high precision that has not been reported in previous published works.

6. Conclusions

- In this work, proximate and ultimate analyses of 4540 coal samples from 25 U.S. states and two mathematical modelling methods, i.e., multi-variable regression and adaptive neuro-fuzzy interface systems were used to estimate GCV.
 - The best-correlated linear equation was achieved using input set (c) (C, H_{ex}, N, O_{ex}, S, M, ash) with a correlation coefficient of 0.995. The results also showed that, for input set (c), the difference between actual and predicted values of GCV in about 78% of the data was less than 0.5 MJ/kg, and, in 96% of the data, the difference was less than 1 MJ/kg.
 - Exponential equations provided improved correlation coefficients in comparison to linear equations. The best result was achieved using input set (c) with a correlation coefficient of 0.999. The difference between actual and predicted values of GCV in about 75% of the data was less than 0.5 MJ/kg, and, in 99% of the data, the difference was less than 1 MJ/kg.
 - The neuro-fuzzy modeling system improved prediction accuracy for input sets (a), (b), and (c).
 - The neuro-fuzzy rules that were designed using 3, 5, and 12 membership functions can predict the GCV with R² = 0.997, 0.999, and 0.999, respectively. They also produced a deviation from target values of less than 0.5 MJ/kg for about 83, 97, and 99% of data, respectively, and less than 1 MJ/kg for about 99, 100, and 100% of data for input sets (a), (b), and (c), respectively.
 - The GCV prediction precision achieved in the current work using neuro-fuzzy systems has not been reported previously in the literature.

7. References

- Babuska, R. (1998). *Fuzzy modeling for control*, Kluwer Academic Publisher, Boston.
- Boyacioglu, M.A. & Avci, D. (2010). An Adaptive Network-Based Fuzzy Inference System (ANFIS) for the prediction of stock market return: The case of the Istanbul Stock Exchange, *Expert Systems with Applications*, Volume 37, Issue 12, 7908-7912.
- Bagherieh, A.H.; Hower, J.C.; Bagherieh, A.R. & Jorjani, E. (2008). Studies of the relationship between petrography and grindability for Kentucky coals using

- artificial neural network . *International Journal of Coal Geology*, Volume 73, Issue 2, 130-138.
- Bragg, L.J. ; Oman, J.K. ; Tewalt, S.J. ; Oman, C.J. ; Rega, N.H. ; Washington, P.M. & Finkelman, R.B. (2009). U.S. *Geological Survey Coal Quality (COALQUAL) database version 2.0. open-file report 97-134*, <http://energy.er.usgs.gov/products/databases/CoalQual/index.htm>.
- Chong-lin, W. ; Cao-yuan, M. ; Jian-hua, L. ; Guo-xin, L. ; Dong-liang, Z. & Jie-jie, T. (2009). Study on coal face stray current safety early warning based on ANFIS, *Procedia Earth and Planetary Science*, Volume 1, Issue 1, 1332-1336.
- Chen, S. ; Cowan, C.F.N. & Grant, P.M. (1991). Orthogonal least squares learning algorithm for radial basis function networks. *IEEE Trans. Neural Networks*, 2 (2), 302-309.
- Custer, V.F. (1951). Uber die Berechnung des Heizwertes von Kohlen der Immediatzusammensetzung. *Brennst.-Chem*, 32, 19-20.
- Channiwala, S.A. & Parikh, P.P. (2002). A unified correlation for estimating HHV of solid, Liquid and gaseous fuels. *Fuel*, 81, 1051-1063.
- Chehreh Chelgani, S. ; Hower, J.C. ; Jorjani, E. ; Mesroghli, Sh. & Bagherieh, A.H. (2008). Prediction of coal grindability based on petrography, proximate and ultimate analysis using multiple regression and artificial neural network models, *Fuel Processing Technology*, Volume 89, Issue 1, 13-20.
- Chehreh Chelgani, S. ; Mesroghli, Sh. & Hower, J.C. (2010). Simultaneous prediction of coal rank parameters based on ultimate analysis using regression and artificial neural network. *International Journal of Coal Geology*, Volume 83, Issue 1, 31-34.
- Esen, H. & Inalli, M. (2010). ANN and ANFIS models for performance evaluation of a vertical ground source heat pump system , *Expert Systems with Applications*, Volume 37, Issue 12, 8134-8147.
- Given, P.H. ; Weldon, D. & Zoeller, J.H. (1986). Calculation of calorific values of coals from ultimate analyses: theoretical basis and geochemical implications. *Fuel*, 65, 849-854.
- Hower, J.C. & Eble, C.F. (1996). Coal quality and coal utilization. *Energy Miner. Div. Hourglass* 30 (7), 1-8.
- Hansen, J.V. & Meservy, R.D. (1996). Learning experiments with genetic optimization of a generalized regression neural network. *Decis. Support Syst.*, 18 (3-4), 317-325.
- Jorjani, E., Chehreh Chelgani, S. & Mesroghli, Sh. (2007). Prediction of microbial desulfurization of coal using artificial neural networks , *Minerals Engineering*, Volume 20, Issue 14, 1285-1292.
- Jorjani, E. ; Mesroghli, Sh. & Chehreh Chelgani, S. (2008). Prediction of operational parameters effect on coal flotation using artificial neural network. *Journal of University of Science and Technology Beijing, Mineral, Metallurgy, Material*, Volume 15, Issue 5, 528-533.
- Jantzen J. (1998). *Neurofuzzy modelling*, Technical University of Denmark, Department of Automation, Tech. report no 98-H-874, 1-28.
- Jang, J.S.R. & Sun, C.T. (1995). Neuro-fuzzy modeling and control, *Proceedings of the IEEE*, 83(3): 378-406.
- Khandelwal, M. & Singh, T.N. (2010). Prediction of macerals contents of Indian coals from proximate and ultimate analyses using artificial neural networks, *Fuel*, Volume 89, Issue 5, 1101-1109.

- Karacan, C.O. (2007). Development and application of reservoir models and artificial neural networks for optimizing ventilation air requirements in development mining of coal seams, *International Journal of Coal Geology*, Volume 72, Issues 3-4, 221-239.
- Mason, D.M. & Gandhi, K.N. (1983). Formulas for calculating the calorific value of coal and chars. *Fuel Process. Technol.* 7, 11-22.
- Miller, B.G. (2005). *Coal Energy Systems*, Elsevier Academic Press, ISBN: 0-12-497451-1, USA.
- Mazumdar, B.K. (1954). Coal systematics: deductions from proximate analysis of coal part I. *J. Sci. Ind. Res.*, 13B (12), 857-863.
- Majumder, A.K. ; Jain, R. ; Banerjee, J.P. & Barnwal, J.P. (2008). Development of a new proximate analysis based correlation to predict calorific value of coal. *Fuel*, 87, 3077-3081.
- Mesroghli, Sh. ; Jorjani, E. & Chehreh Chelgani, S. (2009). Estimation of gross calorific value based on coal analysis using regression and artificial neural networks. *International Journal of Coal Geology*, 79, 49-54.
- Patel, S.U. ; Kumar, B.J. ; Badhe, Y.P. ; Sharma, B.K. ; Saha, S. ; Biswas, S. ; Chaudhury, A. ; Tambe, S.S. & Kulkarni, B.D. (2007). Estimation of gross calorific value of coals using artificial neural. *Fuel*, Volume 86, Issue 3, 334-344.
- Pena, B. ; Teruel, E. & Diez, L.I. (2010). Soft-computing models for soot-blowing optimization in coal-fired utility boilers, *Applied Soft Computing*, In Press, Corrected Proof.
- Parikh, J. ; Channiwala, S.A. & Ghosal, G.K. (2005). A correlation for calculating HHV from proximate analysis of solid fuels. *Fuel*, 84, 487-494.
- Soltani, F. ; Kerachian, R. & Shirangi, E. (2010). Developing operating rules for reservoirs considering the water quality issues: Application of ANFIS-based surrogate models, *Expert Systems with Applications*, Volume 37, Issue 9, 6639-6645.
- Specht, D.F. (1991). A generalized regression neural network. *IEEE Trans. Neural Netw.*, 2(5), 568-576.
- Salehfar, H. & Benson, S.A. (1998). Electric utility coal quality analysis using artificial neural network techniques, *Neurocomputing*, Volume 23, Issues 1-3, 195-206.
- Spooner, C.E. (1951). Swelling power of coal. *Fuel*, 30, 193-202.
- SPSS. (2004). Help Files, Version 13, SPSS Inc.
- Wu, Q.; Ye, S. & Yu, J. (2008). The prediction of size-limited structures in a coal mine using Artificial Neural Networks. *International Journal of Rock Mechanics and Mining Sciences*, Volume 45, Issue 6, 999-1006.
- Wasserman, P.D. (1993). *Advanced methods in neural computing*. Van Nostrand Reinhold, New York, 155-161.
- Zhenyu, Z. & Yongmo, X. (1996). *Introduction to fuzzy theory, neural networks, and their applications*. Beijing/Nanning: Tsinghua University Press/Guangxi Science and Technology Press, in Chinese.
- Sahu, H.B. ; Padhee, S. & Mahapatra, S.S. (2010). Prediction of spontaneous heating susceptibility of Indian coals using fuzzy logic and artificial neural network models, *Expert Systems with Applications*, In Press, Uncorrected Proof.



Artificial Neural Networks - Industrial and Control Engineering Applications

Edited by Prof. Kenji Suzuki

ISBN 978-953-307-220-3

Hard cover, 478 pages

Publisher InTech

Published online 04, April, 2011

Published in print edition April, 2011

Artificial neural networks may probably be the single most successful technology in the last two decades which has been widely used in a large variety of applications. The purpose of this book is to provide recent advances of artificial neural networks in industrial and control engineering applications. The book begins with a review of applications of artificial neural networks in textile industries. Particular applications in textile industries follow. Parts continue with applications in materials science and industry such as material identification, and estimation of material property and state, food industry such as meat, electric and power industry such as batteries and power systems, mechanical engineering such as engines and machines, and control and robotic engineering such as system control and identification, fault diagnosis systems, and robot manipulation. Thus, this book will be a fundamental source of recent advances and applications of artificial neural networks in industrial and control engineering areas. The target audience includes professors and students in engineering schools, and researchers and engineers in industries.

How to reference

In order to correctly reference this scholarly work, feel free to copy and paste the following:

F. Rafezi, E. Jorjani and Sh. Karimi (2011). Adaptive Neuro-Fuzzy Inference System Prediction of Calorific Value Based on the Analysis of U.S. Coals, *Artificial Neural Networks - Industrial and Control Engineering Applications*, Prof. Kenji Suzuki (Ed.), ISBN: 978-953-307-220-3, InTech, Available from: <http://www.intechopen.com/books/artificial-neural-networks-industrial-and-control-engineering-applications/adaptive-neuro-fuzzy-inference-system-prediction-of-calorific-value-based-on-the-analysis-of-u-s-coa>

INTECH
open science | open minds

InTech Europe

University Campus STeP Ri
Slavka Krautzeka 83/A
51000 Rijeka, Croatia
Phone: +385 (51) 770 447
Fax: +385 (51) 686 166
www.intechopen.com

InTech China

Unit 405, Office Block, Hotel Equatorial Shanghai
No.65, Yan An Road (West), Shanghai, 200040, China
中国上海市延安西路65号上海国际贵都大饭店办公楼405单元
Phone: +86-21-62489820
Fax: +86-21-62489821

© 2011 The Author(s). Licensee IntechOpen. This chapter is distributed under the terms of the [Creative Commons Attribution-NonCommercial-ShareAlike-3.0 License](#), which permits use, distribution and reproduction for non-commercial purposes, provided the original is properly cited and derivative works building on this content are distributed under the same license.

IntechOpen

IntechOpen