

We are IntechOpen, the world's leading publisher of Open Access books Built by scientists, for scientists

4,800

Open access books available

122,000

International authors and editors

135M

Downloads

Our authors are among the

154

Countries delivered to

TOP 1%

most cited scientists

12.2%

Contributors from top 500 universities



WEB OF SCIENCE™

Selection of our books indexed in the Book Citation Index
in Web of Science™ Core Collection (BKCI)

Interested in publishing with us?
Contact book.department@intechopen.com

Numbers displayed above are based on latest data collected.

For more information visit www.intechopen.com



Vibration and Sensitivity Analysis of Spatial Multibody Systems Based on Constraint Topology Transformation

Wei Jiang, Xuedong Chen and Xin Luo
*Huazhong University of Science and Technology
P.R.China*

1. Introduction

Many kinds of mechanical systems are often modeled as spatial multibody systems, such as robots, machine tools, automobiles and aircrafts. A multibody system typically consists of a set of rigid bodies interconnected by kinematic constraints and force elements in spatial configuration (Flores et al., 2008). Each flexible body can be further modeled as a set of rigid bodies interconnected by kinematic constraints and force elements (Wittbrodt et al., 2006). Dynamic modeling and vibration analysis based on multibody dynamics are essential to design, optimization and control of these systems (Wittenburg, 2008 ; Schiehlen et al., 2006). Vibration calculation of multibody systems is usually started by solving large-scale nonlinear equations of motion combined with constraint equations (Laulusa & Bauchau, 2008), and then linearization is carried out to obtain a set of linearized differential-algebraic equations (DAEs) or second-order ordinary differential equations (ODEs) (Cruz et al., 2007; Minaker & Frise, 2005; Negrut & Ortiz, 2006; Pott et al., 2007; Roy & Kumar, 2005). This kind of method is necessary for solving the dynamics of nonlinear systems with large deformation.

However, there are two major disadvantages for vibration calculation of multibody systems by using the conventional methods. On one hand, the computational efficiency is very low due to a large amount of efforts usually required for computation of trigonometric functions, derivation and linearization. Many approaches have been proposed to simplify the formulation, such as proper selection of reference frames (Wasfy & Noor, 2003), generalized coordinates (Attia, 2006; Liu et al., 2007; McPhee & Redmond, 2006; Valasek et al., 2007), mechanics principles (Amirouche, 2006; Eberhard & Schiehlen, 2006), and other methods (Richard et al., 2007; Rui et al., 2008). On the other hand, despite sensitivity analysis of multibody systems based on the conventional methods are well documented (Anderson & Hsu, 2002; Choi et al., 2004; Ding et al., 2007; Sliva et al. 2010; Sohl & Bobrow, 2001; Van Keulen et al. 2005; Xu et al., 2009), the formulation is quite complicated because the resulting equations are implicit functions of the design parameters.

Actually, what people concern, for many kinds of mechanical systems under working conditions, are eigenvalue problems and the relationship between the modal parameters and the design parameters. And the designer needs to know the results as quickly as possible so as to perform optimal design. From this point of view, fast algorithm for

vibration calculation and sensitivity analysis with easiness of application is critical to the design of a complex mechanical system. A novel formulation based on matrix transformation for open-loop multibody systems has been proposed recently (Jiang et al., 2008a). The algorithm has been further improved to directly generate the open-loop constraint matrix instead of matrix multiplication (Jiang et al., 2008b). The computational efficiency has been significantly improved, and the resulting equations are explicit functions of the design parameters that can be easily applied for sensitivity analysis. Particularly, the proposed method can be used to directly obtain sensitivity of system matrices about design parameters which are required to perform mode shape sensitivity analysis (Lee et al., 1999a; 1999b).

Vibration calculation of general multibody system containing closed-loop constraints is investigated in this article. Vibration displacements of bodies are selected as generalized coordinates. The translational and rotational displacements are integrated in spatial notation. Linear transformation of vibration displacements between different points on the same rigid body is derived. Absolute joint displacement is introduced to give mathematical definition for ideal joint in a new form. Constraint equations written in this way can be solved easily via the proposed linear transformation. A new formulation based on constraint-topology transformation is proposed to generate oscillatory differential equations for a general multibody system, by matrix generation and quadric transformation in three steps:

1. Linearized ODEs in terms of absolute displacements are firstly derived by using Lagrangian method for free multibody system without considering any constraint.
2. An open-loop constraint matrix B' is derived to formulate linearized ODEs via quadric transformation $E' = B'^T E B'$ ($E = M, K, C$) for open-loop multibody system, which is obtained from closed-loop multibody system by using cut-joint method.
3. A constraint matrix B'' corresponding to all cut-joints is finally derived to formulate a minimal set of ODEs via quadric transformation $E'' = B''^T E' B''$ ($E = M, K, C$) for closed-loop multibody system.

Complicated solving for constraints and linearization are unnecessary for the proposed method, therefore the procedure of vibration calculation can be greatly simplified. In addition, since the resulting equations are explicit functions of the design parameters, the suggested method is particularly suitable for sensitivity analysis and optimization for large-scale multibody system, which is very difficult to be achieved by using conventional approaches.

Large-scale spatial multibody systems with chain, tree and closed-loop topologies are taken as case studies to verify the proposed method. Comparisons with traditional approaches show that the results of vibration calculation by using the proposed method are accurate with improved computational efficiency. The proposed method has also been implemented in dynamic analysis of a quadruped robot and a Stewart isolation platform.

2. Fundamentals of multibody dynamics

2.1 Description of multibody system

As shown in Fig. 1, considering a multibody system which consists of n rigid bodies and the ground B_0 , each two bodies are probably interconnected by at most one joint and arbitrary number of spatial spring-dampers. A spatial spring-damper means an integration

of three spring-dampers and three torsional spring-dampers. Each joint contains at least one and at most six holonomic constraints. B_i denotes the i^{th} rigid body, and J_{ij} is the joint between B_i and B_j , where $i, j = 1, 2, \dots, n$ and $i \neq j$. s_{ij} denotes the total number of spring-dampers between B_i and B_j , among which K_{ijs} is the s^{th} one, where $s = 0, 1, 2, \dots, s_{ij}$. $s_{ij} = 0$ means there is no spring-damper between B_i and B_j .

Four kinds of reference frames are used in the formulation. The global reference frame, namely the inertial frame, i.e., $o-xyz$, is fixed on the ground. The body reference frame, e.g., c_i-xyz for B_i , is fixed in the space with its origin coinciding with the center of mass (CM) of the body. For simplicity without loss of generality, all body reference frames are set to be parallel to $o-xyz$ in this paper. The spring reference frame, e.g., $u_{ijs}-x'y'z'$ for K_{ijs} , is located at one of the spring acting points. The joint reference frame, e.g., $v_{ij}-x''y''z''$ for J_{ij} , is located at one of the joint acting points.

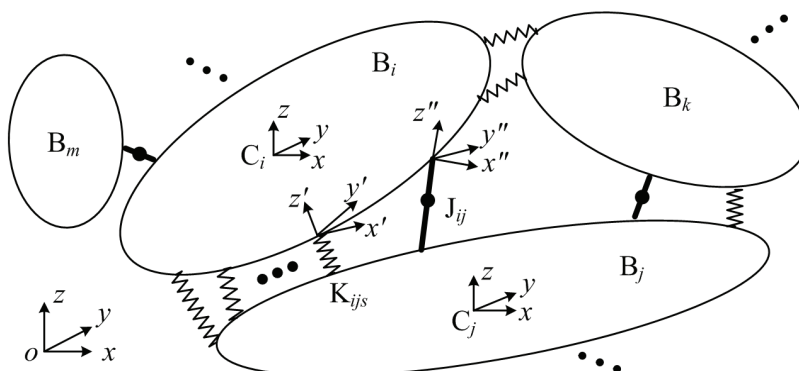

Fig. 1. Elements and reference frames in multibody system

Define m_i the mass of B_i , J_i the inertia tensor of B_i with respect to c_i-xyz , and I the 3×3 identity matrix. Then the mass matrix of body B_i with respect to c_i-xyz is given by

$$M_i = \text{diag}(m_i I \quad J_i) \tag{1}$$

The mass matrix of the free multibody system can be organized as

$$M = \text{diag}(M_1 \quad M_2 \quad \dots \quad M_n) \tag{2}$$

The translation of CM of B_i is specified via vector $r_i = [x_i \quad y_i \quad z_i]^T$. The rotation of B_i is specified via Bryan angles $\theta_i = [\alpha_i \quad \beta_i \quad \gamma_i]^T$. The absolute angular velocities can be written as (Wittenburg, 2008)

$$\omega_i = \begin{bmatrix} \omega_{ix} \\ \omega_{iy} \\ \omega_{iz} \end{bmatrix} = \begin{bmatrix} C_{\beta i} C_{\gamma i} & S_{\gamma i} & 0 \\ -C_{\beta i} S_{\gamma i} & C_{\gamma i} & 0 \\ S_{\beta i} & 0 & 1 \end{bmatrix} \begin{bmatrix} \dot{\alpha}_i \\ \dot{\beta}_i \\ \dot{\gamma}_i \end{bmatrix} \tag{3}$$

where $S_\mu = \sin \mu$, $C_\mu = \cos \mu$ ($\mu = \alpha_i, \beta_i, \gamma_i$).

Due to small angular displacements of bodies, i.e., $\alpha_i, \beta_i, \gamma_i \approx 0$, the absolute angular velocities and displacements can be linearized as (Wittenburg, 2008)

$$\omega_i \approx [\dot{\alpha}_i \quad \dot{\beta}_i \quad \dot{\gamma}_i]^T = \dot{\theta}_i \tag{4}$$

$$\Theta = \int \omega_i dt \approx \int \dot{\theta}_i dt = \theta_i \quad (5)$$

The spatial displacements of B_i can be unified as

$$\mathbf{q}_i = [\mathbf{r}_i^T \ \boldsymbol{\theta}_i^T]^T = [x_i \ y_i \ z_i \ \alpha_i \ \beta_i \ \gamma_i]^T \quad (6)$$

The displacements and velocities for free multibody system can be organized as $\mathbf{q} = [\mathbf{q}_1^T \ \mathbf{q}_2^T \ \dots \ \mathbf{q}_n^T]^T$ and $\dot{\mathbf{q}} = [\dot{\mathbf{q}}_1^T \ \dot{\mathbf{q}}_2^T \ \dots \ \dot{\mathbf{q}}_n^T]^T$.

The stiffness and damping coefficients of K_{ijs} are defined in spring reference frame $u_{ijs}-x'y'z'$ as $\mathbf{K}_{ijs}^u = \text{diag}(k_x \ k_y \ k_z \ k_\alpha \ k_\beta \ k_\gamma)$, $\mathbf{C}_{ijs}^u = \text{diag}(c_x \ c_y \ c_z \ c_\alpha \ c_\beta \ c_\gamma)$. P_{ijs} and P_{jis} are the acting points of K_{ijs} on B_i and B_j . $\bar{\mathbf{r}}_{ijs} = [\bar{x}_{ijs} \ \bar{y}_{ijs} \ \bar{z}_{ijs}]^T$ denotes the original position of P_{ijs} relative to c_i-xyz . $\bar{\mathbf{r}}_{jis} = [\bar{x}_{jis} \ \bar{y}_{jis} \ \bar{z}_{jis}]^T$ denotes the original position of P_{jis} relative to c_j-xyz . $\bar{\boldsymbol{\theta}}_{ijs} = [\bar{\alpha}_{ijs} \ \bar{\beta}_{ijs} \ \bar{\gamma}_{ijs}]^T$ denotes the original orientation of K_{ijs} relative to c_i-xyz .

Most of the joints that used for practical applications can be modeled in terms of the so-called lower pairs, including revolute, prismatic, cylindrical, universal, spherical, and planar joints. Each joint reduces corresponding number of degrees of freedom (DOFs) of the distal body (Pott et al., 2007; Müller, 2004) between two connected bodies. Assume there is an ideal joint J_{ij} between body B_i and B_j . The acting points of J_{ij} on B_i and B_j are marked as Q_{ij} and Q_{ji} , respectively. $\bar{\mathbf{r}}_{ijq} = [\bar{x}_{ijq} \ \bar{y}_{ijq} \ \bar{z}_{ijq}]^T$ denotes the original position of Q_{ij} relative to c_i-xyz . $\bar{\mathbf{r}}_{jiq} = [\bar{x}_{jiq} \ \bar{y}_{jiq} \ \bar{z}_{jiq}]^T$ denotes the original position of Q_{ji} relative to c_j-xyz . $\bar{\boldsymbol{\theta}}_{ij} = [\bar{\alpha}_{ij} \ \bar{\beta}_{ij} \ \bar{\gamma}_{ij}]^T$ denotes the original orientation of J_{ij} relative to c_i-xyz . \mathbf{q}_{ij}^v and \mathbf{q}_{ji}^v are absolute joint displacements of Q_{ij} and Q_{ji} with respect to $v_i-x''y''z''$. A 6×6 diagonal matrix \mathbf{H} is introduced for each kind of joint to formulate the constraint equations in terms of absolute joint displacements. For example, the constraint equations for joint J_{ij} can be written as

$$\mathbf{H}_{ij} \mathbf{q}_{ij}^v = \mathbf{H}_{ij} \mathbf{q}_{ji}^v \quad (7)$$

The meaning of matrix \mathbf{H} can be explained as follows: the value of each diagonal element in \mathbf{H} is either one or zero, representing whether the DOF along the corresponding axis is constrained or not. In order to reduce the number of constraint equations, another matrix \mathbf{D} is introduced for each kind of joint to extract the independent variables, e.g., for joint J_{ij} it turns to be $\mathbf{q}_{ij}^v = \mathbf{D}_{ij} \mathbf{q}_{ij}^v$. Matrix \mathbf{D} is obtained from matrix $\mathbf{I} - \mathbf{H}$ by removing those rows whose elements are all zero. Matrices for some common joints are shown in Table 1.

Transmission mechanisms are another kind of constraints widely used in mechanical systems, such as gear pair, rackandpinion, worm gear pair, screw pair, etc. They are usually related to a pair of joints, therefore the constraint equations can be written in terms of absolute joint displacements. Suppose there is a transmission mechanism T_{kr} between body B_k and B_r , T_{kr} is related to joint J_{jk} and J_{mr} . The joint acting point of J_{jk} on B_k is marked as Q_{jk} , and that of J_{mr} on B_r is marked as Q_{mr} . The constraint equations for T_{kr} can be expressed as

$$\mathbf{G}_k \mathbf{q}_{jk}^v + \mathbf{G}_r \mathbf{q}_{mr}^v = \mathbf{0} \quad (8)$$

where \mathbf{q}_{jk}^v is the absolute joint displacement of Q_{jk} with respect to $v_{jk}-x''y''z''$, and \mathbf{q}_{mr}^v is that of Q_{mr} with respect to $v_{mr}-x''y''z''$. Matrices \mathbf{G}_k and \mathbf{G}_r are used to extract variables relative to transmission mechanism. Matrices for some common transmission mechanisms are shown in Table 2, in which i is the transmission ratio.

Joint type	Free axes	Matrix H	Matrix D
Fixed	none	I_6	null matrix
revolute	γ	diag(1 1 1 1 1 0)	[0 0 0 0 0 1]
prismatic	z	diag(1 1 0 1 1 1)	[0 0 1 0 0 0]
cylindrical	z, γ	diag(1 1 0 1 1 0)	$\begin{bmatrix} 0 & 0 & 1 & 0 & 0 & 0 \\ 0 & 0 & 0 & 0 & 0 & 1 \end{bmatrix}$
universal	α, β	diag(1 1 1 0 0 1)	$\begin{bmatrix} 0 & 0 & 0 & 1 & 0 & 0 \\ 0 & 0 & 0 & 0 & 1 & 0 \end{bmatrix}$
spherical	α, β, γ	diag(1 1 1 0 0 0)	$\begin{bmatrix} 0 & 0 & 0 & 1 & 0 & 0 \\ 0 & 0 & 0 & 0 & 1 & 0 \\ 0 & 0 & 0 & 0 & 0 & 1 \end{bmatrix}$
planar	x, y, γ	diag(0 0 1 1 1 0)	$\begin{bmatrix} 1 & 0 & 0 & 0 & 0 & 0 \\ 0 & 1 & 0 & 0 & 0 & 0 \\ 0 & 0 & 0 & 0 & 0 & 1 \end{bmatrix}$
...

Table 1. Mathematical definition of some common joints

Transmission	Constraint equation	Matrix G_1	Matrix G_2
Gear pair	$\hat{\gamma}_1 + i \hat{\gamma}_2 = 0$	[0 0 0 0 0 1]	[0 0 0 0 0 i]
Worm gear pair	$\hat{\gamma}_1 + i \hat{\gamma}_2 = 0$	[0 0 0 0 0 1]	[0 0 0 0 0 i]
Rackandpinion	$\hat{\gamma}_1 + i \hat{z}_2 = 0$	[0 0 0 0 0 1]	[0 0 i 0 0 0]
Screw pair	$\hat{\gamma}_1 + i \hat{z}_1 - i \hat{z}_2 = 0$	[0 0 i 0 0 1]	[0 0 $-i$ 0 0 0]
...

Table 2. Mathematical definition of some transmission mechanisms

2.2 Linear transformation of vibration displacements

Transformation of displacements of two points on a same rigid body is fundamental to the dynamics of a multibody system. The transformation can be divided into two steps. Firstly, the displacements of spring acting point are formulated by using the displacements of CM on the same body, with respect to the same reference frame. And then the resulting displacements are transformed from body reference frame to spring reference frame. A linear transformation is proposed for vibration displacements based on homogeneous transformation.

Assume that there are two reference frames, $c-xyz$ and $u-x'y'z'$. The direction cosine matrix from $c-xyz$ to $u-x'y'z'$ is determined by $\theta = [\alpha \ \beta \ \gamma]^T$ as follows

$$A^{cu} = \begin{bmatrix} C_\beta C_\gamma & C_\alpha S_\gamma + S_\alpha S_\beta C_\gamma & S_\alpha S_\gamma - C_\alpha S_\beta C_\gamma \\ -C_\beta S_\gamma & C_\alpha C_\gamma - S_\alpha S_\beta S_\gamma & S_\alpha C_\gamma + C_\alpha S_\beta S_\gamma \\ S_\beta & -S_\alpha C_\beta & C_\alpha C_\beta \end{bmatrix} \quad (9)$$

where $S_\mu = \sin \mu$, $C_\mu = \cos \mu$ ($\mu = \alpha, \beta, \gamma$).

The translational and rotational displacements of a same rigid body can be integrated as a spatial vector, as shown in Fig. 2. And its transformation between different reference frames can be expressed as

$$q_c^u = \begin{bmatrix} r_c^u \\ \theta_c^u \end{bmatrix} = \begin{bmatrix} A^{cu} & \mathbf{0} \\ \mathbf{0} & A^{cu} \end{bmatrix} \begin{bmatrix} r_c^c \\ \theta_c^c \end{bmatrix} = R^{cu} q_c^c \quad (10)$$

Suppose C and P are two different points on a same rigid body. As shown in Fig. 3, $\bar{r}_{CP} = [\bar{x}_{CP} \ \bar{y}_{CP} \ \bar{z}_{CP}]^T$ denotes the position of P relative to C . $q_c = [r_c^T \ \theta_c^T]^T$ denotes the vector of displacements of point C . Notice that point mentioned in this paper is actually mark that has angular displacements. The translational displacements of point P can be expressed as

$$\begin{aligned} r_p &= \bar{r}_{OP'} - \bar{r}_{OP} \\ &= \bar{r}_{OC} + r_c + \bar{r}_{CP'} - (\bar{r}_{OC} + \bar{r}_{CP}) \\ &= r_c + A^{-1} \bar{r}_{CP} - \bar{r}_{CP} \\ &= r_c + (A^T - I) \bar{r}_{CP} \end{aligned} \quad (11)$$

The rotational displacements of different points on a same rigid body are equal to each other, i.e., $\theta_p = \theta_c$. It means that the translational and rotational displacements of point P can be integrated as

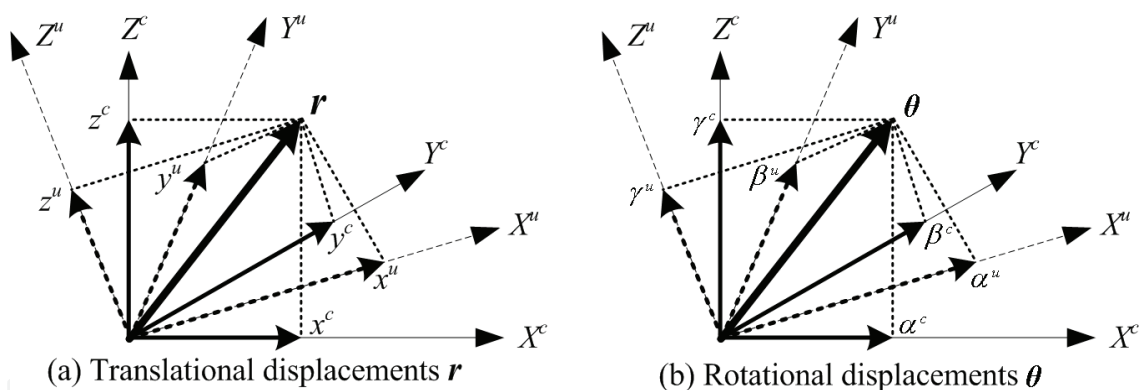

Fig. 2. Finite displacements of the same rigid body in two frames

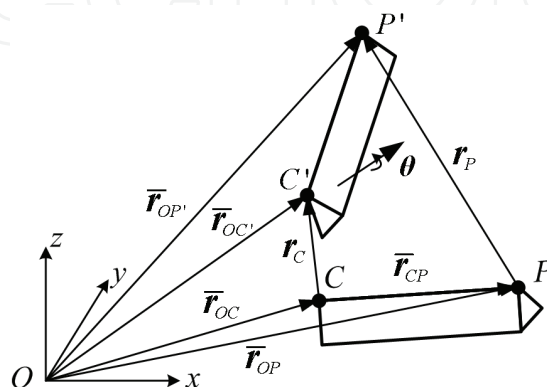

Fig. 3. Finite displacements of two points on a same rigid body

$$\mathbf{q}_p = \begin{bmatrix} \mathbf{r}_p \\ \boldsymbol{\theta}_p \end{bmatrix} = \begin{bmatrix} \mathbf{r}_c + (\mathbf{A}^T - \mathbf{I})\bar{\mathbf{r}}_{CP} \\ \boldsymbol{\theta}_c \end{bmatrix} \quad (12)$$

Due to small angular displacements for vibration analysis, i.e., $\alpha, \beta, \gamma \approx 0$, the direction cosine matrix in Eq. (9) can be linearized as (Wittenburg, 2008)

$$\mathbf{A} \approx \begin{bmatrix} 1 & \gamma & -\beta \\ -\gamma & 1 & \alpha \\ \beta & -\alpha & 1 \end{bmatrix} \quad (13)$$

Substitute Eq. (13) into Eq.(11), it yields

$$(\mathbf{A}^T - \mathbf{I})\bar{\mathbf{r}}_{CP} \approx \begin{bmatrix} 0 & -\gamma & \beta \\ \gamma & 0 & -\alpha \\ -\beta & \alpha & 0 \end{bmatrix} \begin{bmatrix} \bar{x}_{CP} \\ \bar{y}_{CP} \\ \bar{z}_{CP} \end{bmatrix} = \begin{bmatrix} 0 & -\bar{z}_{CP} & \bar{y}_{CP} \\ \bar{z}_{CP} & 0 & -\bar{x}_{CP} \\ -\bar{y}_{CP} & \bar{x}_{CP} & 0 \end{bmatrix} \begin{bmatrix} \alpha \\ \beta \\ \gamma \end{bmatrix} = \mathbf{U}_{CP}\boldsymbol{\theta}_c \quad (14)$$

Therefore Eq. (12) can be linearized to formulate the relationship between fine displacements of two points on a same rigid body as follows

$$\mathbf{q}_p \approx \begin{bmatrix} \mathbf{I} & \mathbf{U}_{CP} \\ \mathbf{0} & \mathbf{I} \end{bmatrix} \mathbf{q}_c = \mathbf{T}_{CP}\mathbf{q}_c \quad (15)$$

According to description in Section 2, the displacements of spring acting point P_{ijs} in u_{ijs} - $x'y'z'$ can be figured out using fine displacements of CM of the body in c - xyz as follows

$$\mathbf{q}_{ijs}^u = \mathbf{R}_{ijs}^{cu} \mathbf{T}_{ijs} \mathbf{q}_i \quad (16)$$

where \mathbf{R}_{ijs}^{cu} can be formulated using $\bar{\boldsymbol{\theta}}_{ijs}$ according to Eqs. (9) and (10), and \mathbf{T}_{ijs} can be formulated using $\bar{\mathbf{r}}_{ijs}$ according to Eqs. (14) and (15).

Similarly, displacements of joint acting point Q_{ij} in v_{ij} - $x''y''z''$ can be expressed as

$$\mathbf{q}_{ij}^v = \mathbf{R}_{ij}^{cv} \mathbf{T}_{ij} \mathbf{q}_i \quad (17)$$

where \mathbf{R}_{ij}^{cv} can be formulated using $\bar{\boldsymbol{\theta}}_{ij}$ according to Eqs. (9) and (10), and \mathbf{T}_{ij} can be formulated using $\bar{\mathbf{r}}_{ij}$ according to Eqs. (14) and (15).

3. Topology-based vibration formulation of multibody systems

Generally, there might be none or more than one joint in a multibody system. As shown in Fig. 4, the topologies of constraints in multibody systems can be classified into five groups: (a) free, (b) scattered, (c) chain, (d) tree, and (e) closed-loop. Free multibody system means that there is no constraint in the system. Groups (b), (c) and (d) can all be regarded as general open-loop multibody system. Since the spring-dampers do not change the topology of constraints in a multibody system, spring-dampers between two nonadjacent bodies are not displayed in the figure.

Considering a general closed-loop multibody system as shown in Fig. 4(e), body B_i, B_j, B_k and B_r are connected with joints J_{ij}, J_{jk} and J_{rk} , whereas B_j, B_m and B_r are connected with joints J_{jm} and J_{mr} . Without loss of generality, assume that $1 \leq i < j < k < m < r \leq n$. Firstly,

linearized ODEs in terms of absolute displacements are derived by using Lagrangian method for free multibody system without considering any constraint, as shown in Fig. 4(a). Secondly, an open-loop constraint matrix is derived to formulate linearized ODEs via quadric transformation for open-loop multibody system, which is obtained by ignoring all cut-joints (Müller, 2004 ; Pott et al., 2007), e.g., if J_{kr} is chosen as cut-joint and one can obtain open-loop multibody system as shown in Fig. 4(d). Finally, a cut-joint constraint matrix corresponding to all cut-joints is solved to formulate a minimal set of ODEs via quadric transformation for closed-loop multibody system.

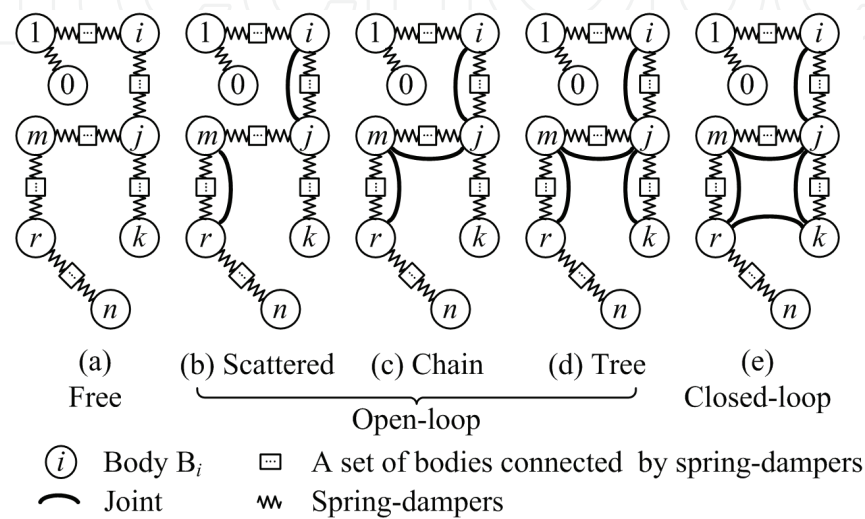

Fig. 4. Topologies of constraints in multibody system

3.1 Vibration formulation of free multibody system

The total kinetic energy of the system as shown in Fig. 4(a) is the summation of translational energy and rotational energy of all bodies, i.e.,

$$T = \sum_{i=1}^n \left(\frac{1}{2} \dot{r}_i^T m_i \dot{r}_i + \frac{1}{2} \omega_i^T J_i \omega_i \right) \approx \sum_{i=1}^n \frac{1}{2} \dot{q}_i^T M_i \dot{q}_i \tag{18}$$

The fine deformation of spring K_{ijs} can be formulated as difference of displacements between P_{ijs} and P_{jis} in $u_{ijs}-x'y'z'$

$$\Delta q_{ijs}^u = q_{jis}^u - q_{ijs}^u = R_{ijs}^{cu} T_{jis} q_j - R_{ijs}^{cu} T_{ijs} q_i \tag{19}$$

Set the potential energy of the system at equilibrium positions to be zero. Then the potential energy of spring K_{ijs} can be formulated as

$$V_{ijs} = \frac{1}{2} (\Delta q_{ijs}^u)^T K_{ijs}^u \Delta q_{ijs}^u \tag{20}$$

The potential energy of the entire system is the sum of gravitational potential V_g and elastic potential V_k , i.e.,

$$V = V_g + V_k = \sum_{i=0}^n q_i^T M_i g + \sum_{i=0}^{n-1} \sum_{j=i+1}^n \sum_{s=0}^{S_{ij}} V_{ijs} \tag{21}$$

where $\mathbf{g} = [0 \ 0 \ g \ 0 \ 0 \ 0]^T$ is the vector of gravitational acceleration. Since there might be no spring-damper between two bodies, a “virtual spring-damper” which has no effect on the system is introduced between each two bodies for consistency in formula. For example, K_{ij0} is the “virtual spring-damper” between body B_i and B_j , and $\mathbf{K}_{ij0}^u = \mathbf{0}$, $\mathbf{C}_{ij0}^u = \mathbf{0}$. The Lagrangian equations of the system take the form

$$\frac{d}{dt} \left(\frac{\partial T}{\partial \dot{\mathbf{q}}_i^T} \right) - \frac{\partial V}{\partial \mathbf{q}_i^T} = \mathbf{f}_{di} + \mathbf{f}_{ei} \quad (22)$$

where $i = 1, 2, \dots, n$, \mathbf{f}_{di} and \mathbf{f}_{ei} denote the damping forces and other non-potential forces acting on body B_i .

Due to property $\mathbf{M}_i^T = \mathbf{M}_i$, it yields

$$\frac{d}{dt} \left(\frac{\partial T}{\partial \dot{\mathbf{q}}_i^T} \right) = \frac{1}{2} (\mathbf{M}_i + \mathbf{M}_i^T) \ddot{\mathbf{q}}_i = \mathbf{M}_i \ddot{\mathbf{q}}_i \quad (23)$$

Substitute Eqs. (19) and (20) into Eq. (21), and derivate V with respect to \mathbf{q}_i^T , it yields

$$\begin{aligned} \frac{\partial V}{\partial \mathbf{q}_i^T} &= \sum_{k=0, k \neq i}^n \frac{\partial \mathbf{q}_k^T}{\partial \mathbf{q}_i^T} \mathbf{M}_k \mathbf{g} + \frac{\partial \mathbf{q}_i^T}{\partial \mathbf{q}_i^T} \mathbf{M}_i \mathbf{g} + \sum_{k=0}^{i-1} \sum_{s=0}^{s_{ki}} \frac{\partial V_{kis}}{\partial \mathbf{q}_i^T} + \sum_{j=i+1}^n \sum_{s=0}^{s_{ij}} \frac{\partial V_{ijs}}{\partial \mathbf{q}_i^T} + \sum_{k=i+1}^{n-1} \sum_{j=k+1}^n \sum_{s=0}^{s_{kjs}} \frac{\partial V_{kjs}}{\partial \mathbf{q}_i^T} \\ &= \mathbf{0} + \mathbf{M}_i \mathbf{g} + \sum_{j=0}^{i-1} \sum_{s=0}^{s_{ij}} \frac{\partial V_{ijs}}{\partial \mathbf{q}_i^T} + \sum_{j=i+1}^n \sum_{s=0}^{s_{ij}} \frac{\partial V_{ijs}}{\partial \mathbf{q}_i^T} + \mathbf{0} \\ &= \mathbf{M}_i \mathbf{g} + \sum_{j=0, j \neq i}^n \sum_{s=0}^{s_{ij}} \frac{\partial V_{ijs}}{\partial \mathbf{q}_i^T} \\ &= \mathbf{M}_i \mathbf{g} + \sum_{j=0, j \neq i}^n \sum_{s=0}^{s_{ij}} \{ (\mathbf{T}_{ijs})^T (\mathbf{R}_{ijs}^{cu})^T \mathbf{K}_{ijs}^u \mathbf{R}_{ijs}^{cu} (\mathbf{T}_{ijs} \mathbf{q}_i - \mathbf{T}_{jis} \mathbf{q}_j) \} \\ &= \mathbf{M}_i \mathbf{g} + \left[\sum_{j=0, j \neq i}^n \sum_{s=0}^{s_{ij}} (\mathbf{T}_{ijs})^T (\mathbf{R}_{ijs}^{cu})^T \mathbf{K}_{ijs}^u \mathbf{R}_{ijs}^{cu} \mathbf{T}_{ijs} \right] \mathbf{q}_i - \sum_{j=0, j \neq i}^n \left[\sum_{s=0}^{s_{ij}} (\mathbf{T}_{ijs})^T (\mathbf{R}_{ijs}^{cu})^T \mathbf{K}_{ijs}^u \mathbf{R}_{ijs}^{cu} \mathbf{T}_{jis} \mathbf{q}_j \right] \end{aligned} \quad (24)$$

Denote

$$\mathbf{E}_{ii} = \sum_{j=0, j \neq i}^n \sum_{s=0}^{s_{ij}} (\mathbf{T}_{ijs})^T (\mathbf{R}_{ijs}^{cu})^T \mathbf{E}_{ijs}^u \mathbf{R}_{ijs}^{cu} \mathbf{T}_{ijs} \quad (25)$$

$$\mathbf{E}_{ij} = \sum_{s=0}^{s_{ij}} (\mathbf{T}_{ijs})^T (\mathbf{R}_{ijs}^{cu})^T \mathbf{E}_{ijs}^u \mathbf{R}_{ijs}^{cu} \mathbf{T}_{jis} \quad (26)$$

Let $\mathbf{E} = \mathbf{K}$, then Eq. (24) can be rewritten as

$$\frac{\partial V}{\partial \mathbf{q}_i^T} = \mathbf{K}_{ii} \mathbf{q}_i - \sum_{j=0, j \neq i}^n \mathbf{K}_{ij} \mathbf{q}_j + \mathbf{M}_i \mathbf{g} \quad (27)$$

The dissipation power due to damping forces can be formulated as (Wittbrodt, 2006)

$$P = - \sum_{i=0}^{n-1} \sum_{j=i+1}^n \sum_{s=0}^{s_{ij}} \frac{1}{2} (\Delta \dot{\mathbf{q}}_{ijs}^u)^T \mathbf{C}_{ijs}^u \Delta \dot{\mathbf{q}}_{ijs}^u \quad (28)$$

Similarly, the damping forces acting on B_i with respect to c_{i-xyz} can be evaluated as

$$\mathbf{f}_{di} = \frac{\partial P}{\partial \dot{\mathbf{q}}_i^T} = -\mathbf{C}_{ii} \dot{\mathbf{q}}_i + \sum_{j=0, j \neq i}^n \mathbf{C}_{ij} \dot{\mathbf{q}}_j \quad (29)$$

It can be proved that C_{ii} and C_{ij} are also determined by Eqs. (25) and (26) for $E = C$. The linearized ODEs for a free multibody system turn to be

$$M\ddot{q} + C\dot{q} + Kq = f_e - f_g \quad (30)$$

where quantities $f_g = [(M_1g)^T \ (M_2g)^T \ \dots \ (M_n g)^T]^T$ and $f_e = [f_{e1}^T \ f_{e2}^T \ \dots \ f_{en}^T]^T$ denote gravity forces and other non-potential forces. The damping matrix C and stiffness matrix K in Eq. (30) take the same form

$$E = \begin{bmatrix} E_{11} & -E_{12} & \dots & -E_{1n} \\ -E_{21} & E_{22} & \dots & \vdots \\ \vdots & \vdots & \ddots & -E_{n-1,n} \\ -E_{n1} & \dots & -E_{n,n-1} & E_{nn} \end{bmatrix} \quad (E = C, K) \quad (31)$$

The block matrices K_{ii} and C_{ii} contain parameters of all springs and dampers that connected with B_i . K_{ij} and C_{ij} contain parameters of all springs and dampers that connected between B_i and B_j . Matrices C and K contain explicitly damping coefficients and stiffness coefficients, and reveal clearly the topology of spring-dampers.

By using the system matrices M , C and K , Eqs (18), (21) and (28) can be reformed as

$$T = \frac{1}{2} \dot{q}^T M \dot{q} \quad (32)$$

$$V = \frac{1}{2} q^T K q + q^T f_g \quad (33)$$

$$P = \frac{1}{2} \dot{q}^T C \dot{q} \quad (34)$$

3.2 Vibration formulation of open-loop multibody system

Select J_{rk} in Fig. 4(e) as cut-joint and one can obtain open-loop multibody system as shown in Fig. 4(d). The constraint equations for joint J_{ij} can be written as

$$H_{ij} q_{ij}^v = H_{ij} R_{ij}^{cv} T_{ij} q_i = H_{ij} q_{ji}^v \quad (35)$$

where q_{ij}^v and q_{ji}^v denote the displacements of joint acting points Q_{ij} and Q_{ji} with respect to $v_{ij}-x''y''z''$, respectively. R_{ij}^{cv} is determined by $\bar{\theta}_{ij}$ according to Eqs. (9) and (10). T_{ij} is determined by \bar{r}_{ij} according to Eqs. (14) and (15).

Due to properties $(I - H_{ij})D_{ij}^T D_{ij} = I - H_{ij}$ and $(R^{cv})^{-1} = R^{vc}$, Eq. (35) can be reformed as

$$\begin{aligned} q_j &= (T_{ji})^{-1} R_{ij}^{vc} H_{ij} R_{ij}^{cv} T_{ij} q_i + (T_{ji})^{-1} R_{ij}^{vc} (I - H_{ij}) q_{ji}^v \\ &= (T_{ji})^{-1} R_{ij}^{vc} H_{ij} R_{ij}^{cv} T_{ij} q_i + (T_{ji})^{-1} R_{ij}^{vc} (I - H_{ij}) D_{ij}^T D_{ij} q_{ji}^v \end{aligned} \quad (36)$$

Define

$$P_{ij} = (T_{ji})^{-1} R_{ij}^{vc} H_{ij} R_{ij}^{cv} T_{ij} \quad (37)$$

$$Q_{ij} = (T_{ji})^{-1} R_{ij}^{vc} (I - H_{ij}) D_{ij}^T \quad (38)$$

Considering that $q'_j = D_{ij}q^v_{ji}$, Eq. (36) can be written as

$$q_j = P_{ij}q_i + Q_{ij}q'_j \quad (39)$$

Similarly, the constraint equations for joint J_{jk} are

$$q_k = P_{jk}P_{ij}q_i + P_{jk}Q_{ij}q'_j + Q_{jk}q'_k \quad (40)$$

The constraint equations for all the rest joints can be formulated similar to Eq. (40). The constraint equations for the entire open-loop system can thus be integrated as

$$q = B'q' \quad (41)$$

The open-loop constraint matrix B' corresponding to system shown in Fig. 4(d) takes the form

$$B' = \begin{bmatrix} I_a & 0 & 0 & 0 & 0 & 0 & 0 & 0 & 0 \\ 0 & I_b & 0 & 0 & 0 & 0 & 0 & 0 & 0 \\ 0 & 0 & I_c & 0 & 0 & 0 & 0 & 0 & 0 \\ 0 & P_{ij} & 0 & Q_{ij} & 0 & 0 & 0 & 0 & 0 \\ 0 & 0 & 0 & 0 & I_d & 0 & 0 & 0 & 0 \\ 0 & P_{jk}P_{ij} & 0 & P_{jk}Q_{ij} & 0 & Q_{jk} & 0 & 0 & 0 \\ 0 & 0 & 0 & 0 & 0 & 0 & I_e & 0 & 0 \\ 0 & P_{jm}P_{ij} & 0 & P_{jm}Q_{ij} & 0 & 0 & 0 & Q_{jm} & 0 \\ 0 & 0 & 0 & 0 & 0 & 0 & 0 & 0 & I_f \\ 0 & P_{mr}P_{jm}P_{ij} & 0 & P_{mr}P_{jm}Q_{ij} & 0 & 0 & 0 & P_{mr}Q_{jm} & Q_{mr} \\ 0 & 0 & 0 & 0 & 0 & 0 & 0 & 0 & I_h \end{bmatrix} \quad (42)$$

where $a = 6i - 6$, $b = 6(j - i - 1)$, $c = 6(k - j - 1)$, $d = 6(m - k - 1)$, $e = 6(r - m - 1)$, and $h = 6(n - r)$. The subscript of each identity matrix I denotes its dimension. Obviously, matrix B' contains information about all joints and reveals constraint topology of open-loop multibody system. In Eq. (41), q' are the general displacements of open-loop multibody system, which are the combination of absolute displacements of CM of unconstrained bodies and absolute joint displacements of constrained bodies, i.e.,

$$q' = [(q'_1)^T \ (q'_2)^T \ \dots \ (q'_n)^T]^T \quad (43)$$

where $q'_j = D_{ij}q^v_{ji}$, $q'_k = D_{jk}q^v_{kj}$, $q'_m = D_{jm}q^v_{mj}$, $q'_r = D_{mr}q^v_{rm}$, $q'_\varepsilon = q_\varepsilon$ ($\varepsilon = 1, 2, \dots, n$ and $\varepsilon \neq j, k, m, r$). Substitute Eq. (41) and its time derivation, i.e., $\dot{q} = B'\dot{q}'$, into Eqs. (32)-(34), it yields

$$\frac{d}{dt} \left(\frac{\partial T}{\partial \dot{q}'^T} \right) = B'^T M B' \ddot{q}' = M' \ddot{q}' \quad (44)$$

$$\frac{\partial V}{\partial q'^T} = B'^T K B' q' + B'^T f_s = K' q' + B'^T f_s \quad (45)$$

$$f_d = \frac{\partial P}{\partial \dot{q}'^T} = B'^T C B' \dot{q}' = C' \dot{q}' \quad (46)$$

It then follows a minimal set of linearized ODEs for an open-loop multibody system

$$M' \ddot{q}' + C' \dot{q}' + K' q' = B'^T (f_e - f_s) \quad (47)$$

where M' , C' and K' are determined via the same quadric transformation

$$E' = B'^T E B' \quad (E = M, K, C) \quad (48)$$

Eq. (47) can be regarded as obtained by multiplying Eq. (30) with B'^T and replacing q by $B'q'$. It indicates that the solution of constraint equations for open-loop multibody system can be directly obtained via quadric transformation upon system matrices for free multibody system, by using the corresponding open-loop constraint matrix B' .

3.3 Vibration formulation of closed-loop multibody system

Considering closed-loop multibody system as shown in Fig. 4(e), similar to Eq. (35), the constraint equations for joint J_{kr} can be expressed as

$$H_{kr} q_{kr}^v = H_{rk} q_{rk}^v \quad (49)$$

where q_{kr}^v and q_{rk}^v denote the displacements of points Q_{kr} and Q_{rk} with respect to $v_{kr} - x''y''z''$, respectively.

Rewrite matrix B' with each six rows as a block, i.e., $B' = [B_1^T \ B_2^T \ \dots \ B_n^T]^T$. According to Eqs. (41) and (17) one can obtain $q_{kr}^v = R_{kr}^{cv} T_{kr} B_k'$ and $q_{rk}^v = R_{rk}^{cv} T_{rk} B_r'$. Then Eq. (49) can be rewritten as

$$H_{kr} R_{kr}^{cv} (T_{kr} B_k' - T_{rk} B_r') q' = 0 \quad (50)$$

If the number of cut-joints in a general spatial closed-loop multibody system is c , the constraint equations for all cut-joints can be integrated as

$$B q' = 0 \quad (51)$$

where $B = [B_1^T \ B_2^T \ \dots \ B_c^T]^T$, and B_i is the coefficient matrix of constraint equations for the i^{th} cut-joint.

Transmission mechanism can be treated as cut-joint. Suppose the constraints between body B_k and B_r in Fig. 4(e) is not a joint J_{kr} as mentioned before but a transmission mechanism T_{kr} . The details of T_{kr} can be seen in section 1. Similar to Eq. (50), constraint equations specified as Eq. (8) can be rewritten as

$$(G_k R_{jk}^{ck} T_{kj} B_k' + G_r R_{mr}^{cr} T_{rm} B_r') q' = 0 \quad (52)$$

If the number of transmission mechanisms in a general multibody system is t , the constraint equations for all transmission mechanisms can be integrated as

$$Z q' = 0 \quad (53)$$

where $Z = [Z_1^T \ Z_2^T \ \dots \ Z_t^T]^T$, and Z_j is the coefficient matrix of constraint equations for the j^{th} transmission mechanism.

Equation (51) and (53) can be integrated as constraint equations for cut-joints as follows

$$\begin{bmatrix} B \\ Z \end{bmatrix} q' = 0 \quad (54)$$

Since there might be redundant constraints in closed-loop system, Eq. (54) can be solved to form independent constraint equations

$$\tilde{q}' = \tilde{B}' q'' \quad (55)$$

where q'' is a vector of all independent variables in q' , and \tilde{q}' is that of dependent ones.

Considering that the elements in q'' or \tilde{q}' are not necessarily consecutive variables in q' , they are reordered by introducing a matrix S as

$$q' = S[q''^T \tilde{q}'^T]^T \quad (56)$$

Substituting Eq. (55) into Eq. (56), and let $B'' = S[I \ (\tilde{B}')^T]^T$, it yields

$$q' = B'' q'' \quad (57)$$

Here we call matrix B'' the cut-joint constraint matrix. Considering Eq. (41), one can obtain

$$q = B' q' = B' B'' q'' \quad (58)$$

Similar to formulation of open-loop multibody system, substitute Eq. (58) and its time derivation, i.e., $\dot{q} = B' B'' \dot{q}''$, into Eqs. (32)-(34), a minimal set of linearized ODEs for closed-loop multibody system can be expressed as

$$M'' \ddot{q}'' + C'' \dot{q}'' + K'' q'' = B''^T B'^T (f_e - f_g) \quad (59)$$

where M'' , C'' and K'' are determined via the same quadric transformation

$$E'' = B''^T E' B'' = B''^T B'^T E B' B'' \quad (E = M, K, C) \quad (60)$$

Equation (59) can be regarded as obtained by multiplying Eq. (47) with the transposed cut-joint constraint matrix B''^T and replacing q' by $B'' q''$. It indicates that the solution of constraint equations for cut-joints can be directly obtained via quadric transformation upon system matrices for open-loop system, by using the corresponding cut-joint constraint matrix B'' .

Complicated solving for constraints and linearization are unnecessary in this method, and the resulting equations contain explicitly the design parameters. The suggested method can be used to greatly simplify the procedure of vibration calculation. Furthermore, the suggested method is particularly suitable for sensitivity analysis and optimization for large-scale multibody system.

The proposed algorithm has been implemented in MATLAB, and is named as AMVA (Automatic Modeling for Vibration Analysis). The eigenvalue problem is solved using standard LAPACK routines. The flowchart of the proposed algorithm is illustrated in Fig. 5.

3.4 Comparison with the traditional methods

The procedure of most of the conventional methods for vibration calculation can be concluded as follows. Firstly, the general-purpose nonlinear equations of motion, in most

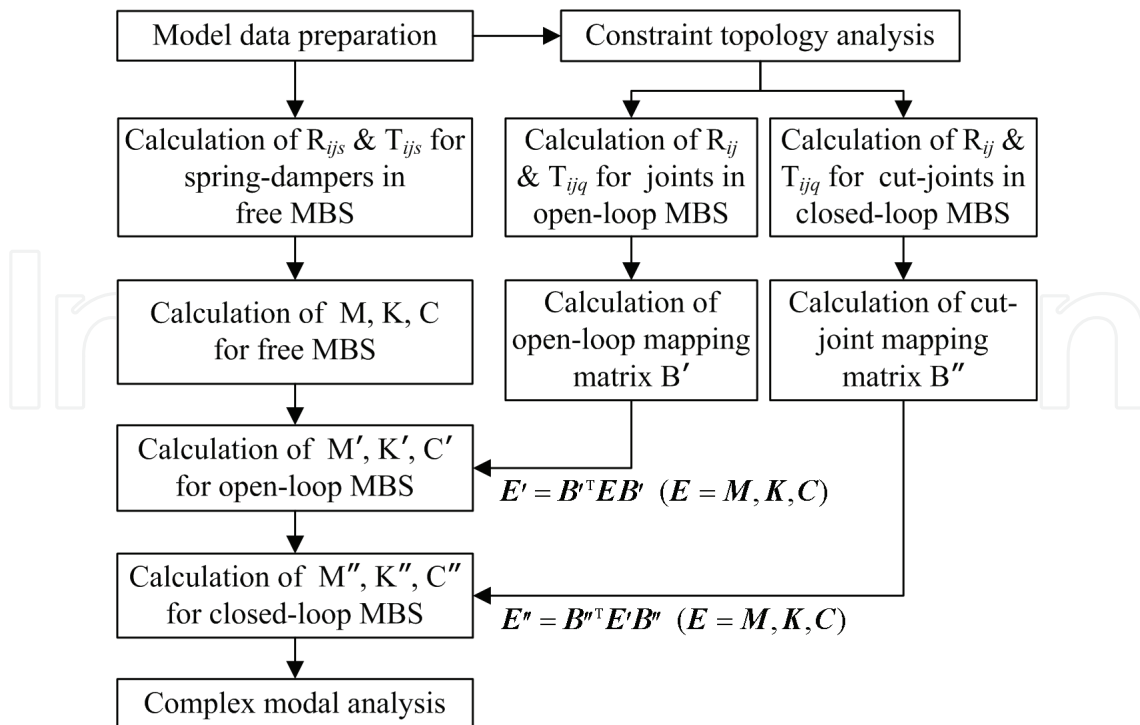

Fig. 5. Flowchart of the proposed formulation

cases DAEs, are formulated in terms of coordinates of all bodies. Secondly, the Jacobian of constraint equations is calculated to transform DAEs into ODEs by eliminating the Lagrange's Multipliers. Thirdly, a minimal set of nonlinear ODEs in terms of independent generalized coordinates are obtained. Finally, the resulting equations are linearized at small vicinity near the equilibrium position. A large amount of computational efforts are required for computation of trigonometric functions, derivation and linearization. Many kinds of software such as ADAMS employ this kind of method for obtaining a minimal set of linear ODEs for vibration analysis.

As shown in Fig. 5, there are three steps in the proposed method to generate a minimal set of second-order linear ODEs for vibration calculation. Firstly, system matrices for linear ODEs of free system are directly generated by using linear transformation. Secondly, an open-loop constraint matrix is formulated to obtain linear ODEs for open-loop system. Finally, a cut-joint constraint matrix is solved to formulate a minimal set of second-order linear ODEs for closed-loop system.

Considering the definitions for vibration calculation, the major difference between the proposed method and previous studies lies in the definition and formulation of constraint equations. Conventionally, the constraint equations are defined in terms of coordinates of bodies or joints. The constraint equations and the Jacobian of constraint matrix are usually nonlinear ones. It is difficult, particularly for large-scale multibody system, to obtain the transformation matrix from the generalized coordinates to the independent coordinates. In this paper, however, the constraint equations are defined in terms of fine displacements of two acting points of the joint. The resulting linear constraint equations can be easily resolved to obtain the transformation matrix, i.e., the open-loop constraint matrix and the cut-joint constraint matrix.

There are two major differences between the proposed method and most of the traditional methods. One is that the linearization is carried out before generating ODEs with small

motion assumption which is satisfied for vibration. The other is that the formulation of a minimal set of second-order linear ODEs for constrained system is achieved by directly generating five matrices, i.e., mass matrix, stiffness matrix and damping matrix for free system, an open-loop constraint matrix B' for open-loop system, and a cut-joint constraint matrix B'' for closed-loop system.

Notice that Kang et al. have also proposed a similar method in which the linearization is carried out before generating ODEs with small motion assumption (Kang, 2003). The results of system matrices for free system are actually the same as those derived by our method. The difference between Kang's method and ours lies in the formulation of a minimal set of ODEs for constrained system. They employ the partition of the Jacobian of constraint matrix, which is time-consuming to be obtained for multibody system with a large amount of constraints, to derive the relationship between generalized coordinates and the independent coordinates. We use the linear transformation matrix to directly formulate linearized constraint equations and then derive the relationship between generalized coordinates and the independent coordinates. Most of all, since the final system matrices can be directly obtained by only a few steps of matrices generation and multiplication, the computational efficiency can be significantly improved for large-scale multibody system with a large amount of constraints.

4. Topology-based sensitivity formulation of multibody systems

Besides the promise in improving the computational efficiency, the proposed method can be applied in sensitivity analysis because the resulting equations depend on the design parameters explicitly. As is known to all, the eigen-sensitivity is based on the derivatives of the system matrices, which are denoted as M'' , C'' and K'' in this paper, with respect to the design parameters (Lee et al., 1999a; 1999b). Conventionally, the system matrices are solved numerically and they depend on the design parameters implicitly. Therefore the derivatives of the system matrices with respect to a certain parameter p are usually obtained by using finite difference method. However, it can be seen that each kind of design parameters can be easily traced in different system matrices obtained by using the proposed method. For example, the stiffness coefficients of spatial spring K_{ijs} only exist in matrix K_{ijs}'' in Eqs. (25) and (26) (E_{ijs}'' refers to K_{ijs}'' for spring). The position parameters of K_{ijs} exist in T_{ijs} and T_{jis} , and its orientation parameters exist in R_{ijs}'' . Similarly, the position and orientation parameters of joint exist in B' and B'' . Therefore the derivatives dM''/dp , dC''/dp and dK''/dp can be further derived analytically.

4.1 Conventional sensitivity formulation

The eigenvalue sensitivity can be expressed as

$$\frac{\partial \lambda_r}{\partial p} = -\lambda_r^2 \boldsymbol{\psi}_r^T \frac{\partial \mathbf{M}''}{\partial p} \boldsymbol{\psi}_r - \lambda_r \boldsymbol{\psi}_r^T \frac{\partial \mathbf{C}''}{\partial p} \boldsymbol{\psi}_r - \boldsymbol{\psi}_r^T \frac{\partial \mathbf{K}''}{\partial p} \boldsymbol{\psi}_r \quad (61)$$

where λ_r is the r^{th} eigenvalue, $\boldsymbol{\psi}_r = [\varphi_{1r} \ \varphi_{2r} \ \dots \ \varphi_{Nr}]^T$ ($N = \text{rank}(\mathbf{M}'')$) is the r^{th} unitary eigenvector, and p represents the considered parameter. Denote m_{ij}'' , c_{ij}'' and k_{ij}'' the elements at row i and column j in matrices \mathbf{M}'' , \mathbf{C}'' and \mathbf{K}'' , respectively, eigenvalue sensitivity can be formulated as

$$\frac{\partial \lambda_r}{\partial m_{ij}''} = \begin{cases} -2\lambda_r^2 \varphi_{ir} \varphi_{jr} & (i \neq j) \\ \lambda_r^2 \varphi_{ir}^2 & (i = j) \end{cases}$$

$$\frac{\partial \lambda_r}{\partial c_{ij}''} = \begin{cases} -2\lambda_r \varphi_{ir} \varphi_{jr} & (i \neq j) \\ \lambda_r \varphi_{ir}^2 & (i = j) \end{cases}$$

$$\frac{\partial \lambda_r}{\partial k_{ij}''} = \begin{cases} -2\varphi_{ir} \varphi_{jr} & (i \neq j) \\ \varphi_{ir}^2 & (i = j) \end{cases}$$

The formulation is very simple. However, matrices M'' , C'' and K'' generated by using conventional methods are implicit functions of design parameters, such as mass and inertia of bodies, stiffness coefficients and damping coefficients of spring-dampers, position and orientation of spring-dampers and joints, and etc. That is to say, m_{ij}'' , c_{ij}'' and k_{ij}'' are intermediate quantities instead of original design parameters. Therefore, the existing sensitivity formula can not be directly used for optimization.

4.2 Proposed sensitivity formulation about physical design parameters

Since matrices M'' , C'' and K'' generated by using the proposed method are explicit functions of design parameters, sensitivity analysis about design parameters can be easily carried out. Considering that $E'' = B''^T B' E B' B''$ ($E = M, K, C$), eigenvalue sensitivity about design parameter p in Eq. (61) can be expressed as follows

$$\begin{aligned} \frac{\partial \lambda_r}{\partial p} &= -\lambda_r^2 \psi_r^T \frac{\partial M''}{\partial p} \psi_r - \lambda_r \psi_r^T \frac{\partial C''}{\partial p} \psi_r - \psi_r^T \frac{\partial K''}{\partial p} \psi_r \\ &= -\psi_r^T B''^T B'^T \left(\lambda_r^2 \frac{\partial M}{\partial p} + \lambda_r \frac{\partial C}{\partial p} + \frac{\partial K}{\partial p} \right) B' B'' \psi_r - 2\psi_r^T B''^T B'^T (\lambda_r^2 M + \lambda_r C + K) \frac{\partial (B' B'')}{\partial p} \psi_r \end{aligned} \quad (62)$$

As pointed out in previous derivation, the mass matrix M of free system contains only mass and inertia parameters of each body. The damping matrix C of free system contains only damping coefficients and position and orientation of dampers. The stiffness matrix K of free system contains only stiffness coefficients and position and orientation of springs. Matrices B' and B'' contain information such as position and orientation of all joints. Therefore eigenvalue sensitivity about specific design parameter can be obtained.

a. Eigenvalue sensitivity about mass or inertia parameter

If p is the mass or inertia parameter of body B_i , one can obtain that

$$\frac{\partial M}{\partial p} = \text{diag}(0 \dots 0 \frac{\partial M_i}{\partial p} 0 \dots 0) = M|_{p=1, p_{rest}=0} = M_{sp} \quad (63)$$

where p_{rest} stands for all parameters except p in the system. It means that sensitivity of mass matrix M about mass or inertia parameter p can be directly obtained by reevaluating M under condition that all parameters being equal to zero except $p = 1$. There is no need for calculating derivatives. Accordingly, eigenvalue sensitivity can be formulated as

$$\frac{\partial \lambda_r}{\partial p} = -\lambda_r^2 (B' B'' \psi_r)^T M_{sp} B' B'' \psi_r \quad (64)$$

Considering that M_{sp} is a sparse matrix because most elements in M are irrelative to parameter p , eigenvalue sensitivity can be significantly simplified by reducing dimension in matrix multiplication. Denote $\boldsymbol{\varphi}_r = \mathbf{B}^T \mathbf{B}^n \boldsymbol{\psi}_r$, and rewrite it by integrating each six rows as a block, i.e., $\boldsymbol{\varphi}_{i,r} = \mathbf{B}_i^T \mathbf{B}^n \boldsymbol{\psi}_r$, it yields

$$\boldsymbol{\varphi}_r = [\boldsymbol{\varphi}_{1,r}^T \quad \boldsymbol{\varphi}_{2,r}^T \quad \cdots \quad \boldsymbol{\varphi}_{n,r}^T]^T \quad (65)$$

where n is the number of bodies in the system.

Eigenvalue sensitivity specified by Eq. (62) can be simplified as

$$\frac{\partial \lambda_r}{\partial p} = -\boldsymbol{\varphi}_r^T \lambda_r^2 \frac{\partial \mathbf{M}}{\partial p} \boldsymbol{\varphi}_r = -\lambda_r^2 \boldsymbol{\varphi}_{i,r}^T \frac{\partial \mathbf{M}_i}{\partial p} \boldsymbol{\varphi}_{i,r} \quad (66)$$

It can be seen that computational cost in Eq. (66) has been reduced by n^2 times in compare with that in Eq. (64).

Generally, there might be several components with identical structure used in a multibody system. That is to say, p is used as mass or inertia parameter for a set of bodies numbered as $e = [e_1 \ e_2 \ \cdots \ e_k] \in R^n$. Eigenvalue sensitivity is difficult to be resolved by using traditional method because many elements in M^n are determined by p and therefore they are correlative with each other. However, it can be directly formulated similar to Eq. (62)

$$\frac{\partial \lambda_r}{\partial p} = -\boldsymbol{\varphi}_r^T \lambda_r^2 \frac{\partial \mathbf{M}}{\partial p} \boldsymbol{\varphi}_r = -\lambda_r^2 \sum_{s=1}^k \boldsymbol{\varphi}_{e_s,r}^T \frac{\partial \mathbf{M}_{e_s}}{\partial p} \boldsymbol{\varphi}_{e_s,r} \quad (67)$$

b. Eigenvalue sensitivity about stiffness parameter

Eigenvalue sensitivity about stiffness and damping coefficient can be calculated in the same way. If p is the stiffness coefficient of spring-dampers interconnected between B_i and B_j , one can obtain that

$$\frac{\partial \lambda_r}{\partial p} = -\boldsymbol{\psi}_r^T \mathbf{B}^n \mathbf{B}^T \frac{\partial \mathbf{K}}{\partial p} \mathbf{B}^T \mathbf{B}^n \boldsymbol{\psi}_r = -\boldsymbol{\varphi}_r^T \frac{\partial \mathbf{K}}{\partial p} \boldsymbol{\varphi}_r \quad (68)$$

The variation of p affects only K_{ii} , K_{jj} , K_{ij} and K_{ji} , it can be obtained that

$$\begin{aligned} \frac{\partial K_{ii}}{\partial p} &= \sum_{j=0, j \neq i}^n \sum_{s=0}^{s_{ij}} (\mathbf{T}_{ijs})^T (\mathbf{R}_{ijs}^{cu})^T \frac{\partial \mathbf{K}_{ijs}^u}{\partial p} \mathbf{R}_{ijs}^{cu} \mathbf{T}_{ijs} \\ &= \sum_{j=0, j \neq i}^n \sum_{s=0}^{s_{ij}} (\mathbf{T}_{ijs})^T (\mathbf{R}_{ijs}^{cu})^T \left(\mathbf{K}_{ijs}^u \Big|_{p=1, p_{rest}=0} \right) \mathbf{R}_{ijs}^{cu} \mathbf{T}_{ijs} \\ &= \mathbf{K}_{ii} \Big|_{p=1, p_{rest}=0} \end{aligned} \quad (69)$$

$$\begin{aligned} \frac{\partial K_{ij}}{\partial p} &= \sum_{s=0}^{s_{ij}} (\mathbf{T}_{ijs})^T (\mathbf{R}_{ijs}^{cu})^T \frac{\partial \mathbf{K}_{ijs}^u}{\partial p} \mathbf{R}_{ijs}^{cu} \mathbf{T}_{jis} \\ &= \sum_{s=0}^{s_{ij}} (\mathbf{T}_{ijs})^T (\mathbf{R}_{ijs}^{cu})^T \left(\mathbf{K}_{ijs}^u \Big|_{p=1, p_{rest}=0} \right) \mathbf{R}_{ijs}^{cu} \mathbf{T}_{jis} \\ &= \mathbf{K}_{ij} \Big|_{p=1, p_{rest}=0} \end{aligned} \quad (70)$$

$$\frac{\partial K_{aa}}{\partial p} = \begin{cases} \mathbf{K}_{aa} \Big|_{p=1, p_{rest}=0} & (a = i, j) \\ \mathbf{0} & (a \neq i, j) \end{cases} \quad (71)$$

$$\frac{\partial \mathbf{K}_{ab}}{\partial p} = \begin{cases} \mathbf{K}_{ab}|_{p=1, p_{rest}=0} & (a = i \ \& \ b = j, \text{ or } a = j \ \& \ b = i) \\ \mathbf{0} & (a \neq i \text{ or } b \neq j) \end{cases} \quad (72)$$

Combine Eq. (71) with Eq. (72) and it yields

$$\frac{\partial \mathbf{K}}{\partial p} = \mathbf{K}|_{p=1, p_{rest}=0} = \mathbf{K}_{sp} \quad (73)$$

Considering that \mathbf{K}_{sp} is usually a sparse matrix, eigenvalue sensitivity about stiffness parameter used in springs between B_i and B_j , can be formulated as

$$\frac{\partial \lambda_r}{\partial p} = -\boldsymbol{\varphi}_r^T \frac{\partial \mathbf{K}}{\partial p} \boldsymbol{\varphi}_r = -[\boldsymbol{\varphi}_{i,r}^T \ \boldsymbol{\varphi}_{j,r}^T] \begin{bmatrix} \frac{\partial \mathbf{K}_{ii}}{\partial p} & -\frac{\partial \mathbf{K}_{ij}}{\partial p} \\ -\frac{\partial \mathbf{K}_{ji}}{\partial p} & \frac{\partial \mathbf{K}_{jj}}{\partial p} \end{bmatrix} \begin{bmatrix} \boldsymbol{\varphi}_{i,r} \\ \boldsymbol{\varphi}_{j,r} \end{bmatrix} \quad (74)$$

Generally, there might be several spring-dampers sharing the same stiffness or damping coefficient p in a multibody system. If p is the stiffness coefficient of spring-dampers interconnected between B_i and B_j , and B_j and B_k , it can be obtained that

$$\frac{\partial \lambda_r}{\partial p} = -[\boldsymbol{\varphi}_{i,r}^T \ \boldsymbol{\varphi}_{j,r}^T \ \boldsymbol{\varphi}_{k,r}^T] \begin{bmatrix} \frac{\partial \mathbf{K}_{ii}}{\partial p} & -\frac{\partial \mathbf{K}_{ij}}{\partial p} & \mathbf{0} \\ -\frac{\partial \mathbf{K}_{ji}}{\partial p} & \frac{\partial \mathbf{K}_{jj}}{\partial p} & -\frac{\partial \mathbf{K}_{jk}}{\partial p} \\ \mathbf{0} & -\frac{\partial \mathbf{K}_{kj}}{\partial p} & \frac{\partial \mathbf{K}_{kk}}{\partial p} \end{bmatrix} \begin{bmatrix} \boldsymbol{\varphi}_{i,r} \\ \boldsymbol{\varphi}_{j,r} \\ \boldsymbol{\varphi}_{k,r} \end{bmatrix} \quad (75)$$

If p is the stiffness coefficient of spring-dampers interconnected between B_i and B_j , and B_k and B_l , it can be obtained that

$$\frac{\partial \lambda_r}{\partial p} = -[\boldsymbol{\varphi}_{i,r}^T \ \boldsymbol{\varphi}_{j,r}^T] \begin{bmatrix} \frac{\partial \mathbf{K}_{ii}}{\partial p} & -\frac{\partial \mathbf{K}_{ij}}{\partial p} \\ -\frac{\partial \mathbf{K}_{ji}}{\partial p} & \frac{\partial \mathbf{K}_{jj}}{\partial p} \end{bmatrix} \begin{bmatrix} \boldsymbol{\varphi}_{i,r} \\ \boldsymbol{\varphi}_{j,r} \end{bmatrix} - [\boldsymbol{\varphi}_{k,r}^T \ \boldsymbol{\varphi}_{l,r}^T] \begin{bmatrix} \frac{\partial \mathbf{K}_{kk}}{\partial p} & -\frac{\partial \mathbf{K}_{kl}}{\partial p} \\ -\frac{\partial \mathbf{K}_{lk}}{\partial p} & \frac{\partial \mathbf{K}_{ll}}{\partial p} \end{bmatrix} \begin{bmatrix} \boldsymbol{\varphi}_{k,r} \\ \boldsymbol{\varphi}_{l,r} \end{bmatrix} \quad (76)$$

c. Eigenvalue sensitivity about damping parameter

Similarly, if p is the damping coefficient of spring-dampers interconnected between B_i and B_j , eigenvalue sensitivity about p can be formulated as

$$\frac{\partial \lambda_r}{\partial p} = -\lambda_r \boldsymbol{\varphi}_r^T \frac{\partial \mathbf{C}}{\partial p} \boldsymbol{\varphi}_r = -\lambda_r [\boldsymbol{\varphi}_{i,r}^T \ \boldsymbol{\varphi}_{j,r}^T] \begin{bmatrix} \frac{\partial \mathbf{C}_{ii}}{\partial p} & -\frac{\partial \mathbf{C}_{ij}}{\partial p} \\ -\frac{\partial \mathbf{C}_{ji}}{\partial p} & \frac{\partial \mathbf{C}_{jj}}{\partial p} \end{bmatrix} \begin{bmatrix} \boldsymbol{\varphi}_{i,r} \\ \boldsymbol{\varphi}_{j,r} \end{bmatrix} \quad (77)$$

If p is the damping coefficient of spring-dampers interconnected between B_i and B_j , and B_k and B_l , it can be obtained that

$$\frac{\partial \lambda_r}{\partial p} = -\lambda_r [\boldsymbol{\varphi}_{i,r}^T \quad \boldsymbol{\varphi}_{j,r}^T \quad \boldsymbol{\varphi}_{k,r}^T] \begin{bmatrix} \frac{\partial C_{ii}}{\partial p} & -\frac{\partial C_{ij}}{\partial p} & \mathbf{0} \\ -\frac{\partial C_{ji}}{\partial p} & \frac{\partial C_{jj}}{\partial p} & -\frac{\partial C_{ik}}{\partial p} \\ \mathbf{0} & -\frac{\partial C_{kj}}{\partial p} & \frac{\partial C_{kk}}{\partial p} \end{bmatrix} \begin{bmatrix} \boldsymbol{\varphi}_{i,r} \\ \boldsymbol{\varphi}_{j,r} \\ \boldsymbol{\varphi}_{k,r} \end{bmatrix} \quad (78)$$

If p is the damping coefficient of spring-dampers interconnected between B_i and B_j , and B_k and B_l , it can be obtained that

$$\frac{\partial \lambda_r}{\partial p} = -\lambda_r [\boldsymbol{\varphi}_{i,r}^T \quad \boldsymbol{\varphi}_{j,r}^T] \begin{bmatrix} \frac{\partial C_{ii}}{\partial p} & -\frac{\partial C_{ij}}{\partial p} \\ -\frac{\partial C_{ji}}{\partial p} & \frac{\partial C_{jj}}{\partial p} \end{bmatrix} \begin{bmatrix} \boldsymbol{\varphi}_{i,r} \\ \boldsymbol{\varphi}_{j,r} \end{bmatrix} - \lambda_r [\boldsymbol{\varphi}_{k,r}^T \quad \boldsymbol{\varphi}_{l,r}^T] \begin{bmatrix} \frac{\partial C_{kk}}{\partial p} & -\frac{\partial C_{kl}}{\partial p} \\ -\frac{\partial C_{lk}}{\partial p} & \frac{\partial C_{ll}}{\partial p} \end{bmatrix} \begin{bmatrix} \boldsymbol{\varphi}_{k,r} \\ \boldsymbol{\varphi}_{l,r} \end{bmatrix} \quad (79)$$

4.3 Proposed sensitivity formulation about geometrical design parameters

The position and orientation of connection such as spring-damper and joint affect the dynamics of multibody system too. Eigenvalue sensitivity about these geometrical design parameters will be derived in this section.

If p is the position and orientation of spring-dampers, eigenvalue sensitivity can be formulated as

$$\frac{\partial \lambda_r}{\partial p} = -\boldsymbol{\varphi}_r^T \left(\lambda_r \frac{\partial \mathbf{C}}{\partial p} + \frac{\partial \mathbf{K}}{\partial p} \right) \boldsymbol{\varphi}_r \quad (80)$$

If p is the position and orientation of spring-dampers interconnected between B_i and B_j , similar to Eq. (74), it can be obtained that

$$\frac{\partial \lambda_r}{\partial p} = -[\boldsymbol{\varphi}_{i,r}^T \quad \boldsymbol{\varphi}_{j,r}^T] \begin{bmatrix} \lambda_r \frac{\partial C_{ii}}{\partial p} + \frac{\partial K_{ii}}{\partial p} & -\lambda_r \frac{\partial C_{ij}}{\partial p} - \frac{\partial K_{ij}}{\partial p} \\ -\lambda_r \frac{\partial C_{ji}}{\partial p} - \frac{\partial K_{ji}}{\partial p} & \lambda_r \frac{\partial C_{jj}}{\partial p} + \frac{\partial K_{jj}}{\partial p} \end{bmatrix} \begin{bmatrix} \boldsymbol{\varphi}_{i,r} \\ \boldsymbol{\varphi}_{j,r} \end{bmatrix} \quad (81)$$

In addition, if p is the position of spring-dampers interconnected between B_i and B_j , it can be obtained that

$$\frac{\partial \mathbf{E}_{ii}}{\partial p} = \sum_{s=0}^{s_{ij}} \left[\frac{\partial (\mathbf{T}_{ijs})^T}{\partial p} (\mathbf{R}_{ijs}^{cu})^T \mathbf{E}_{ijs}^u \mathbf{R}_{ijs}^{cu} \mathbf{T}_{ijs} + (\mathbf{T}_{ijs})^T (\mathbf{R}_{ijs}^{cu})^T \mathbf{E}_{ijs}^u \mathbf{R}_{ijs}^{cu} \frac{\partial (\mathbf{T}_{ijs})}{\partial p} \right] \quad (E = K, C) \quad (82)$$

$$\frac{\partial \mathbf{E}_{ij}}{\partial p} = \sum_{s=0}^{s_{ij}} \left[\frac{\partial (\mathbf{T}_{ijs})^T}{\partial p} (\mathbf{R}_{ijs}^{cu})^T \mathbf{E}_{ijs}^u \mathbf{R}_{ijs}^{cu} \mathbf{T}_{jis} + (\mathbf{T}_{ijs})^T (\mathbf{R}_{ijs}^{cu})^T \mathbf{E}_{ijs}^u \mathbf{R}_{ijs}^{cu} \frac{\partial (\mathbf{T}_{jis})}{\partial p} \right] \quad (E = K, C) \quad (83)$$

If p is the orientation of spring-dampers interconnected between B_i and B_j , it can be obtained that

$$\frac{\partial \mathbf{E}_{ii}}{\partial p} = \sum_{s=0}^{s_{ij}} \left[(\mathbf{T}_{ijs})^T \frac{\partial (\mathbf{R}_{ijs}^{cu})^T}{\partial p} \mathbf{E}_{ijs}^u \mathbf{R}_{ijs}^{cu} \mathbf{T}_{ijs} + (\mathbf{T}_{ijs})^T (\mathbf{R}_{ijs}^{cu})^T \mathbf{E}_{ijs}^u \frac{\partial (\mathbf{R}_{ijs}^{cu})}{\partial p} \mathbf{T}_{ijs} \right] \quad (E = K, C) \quad (84)$$

$$\frac{\partial \mathbf{E}_{ij}}{\partial p} = \sum_{s=0}^{s_{ij}} \left[(\mathbf{T}_{ijs})^T \frac{\partial (\mathbf{R}_{ijs}^{cu})^T}{\partial p} \mathbf{E}_{ijs}^u \mathbf{R}_{ijs}^{cu} \mathbf{T}_{jis} + (\mathbf{T}_{ijs})^T (\mathbf{R}_{ijs}^{cu})^T \mathbf{E}_{ijs}^u \frac{\partial (\mathbf{R}_{ijs}^{cu})}{\partial p} \mathbf{T}_{jis} \right] \quad (E = K, C) \quad (85)$$

Generally, p may be used as position and orientation of spring-dampers among a set of bodies in a multibody system. For example, if p is the position and orientation of spring-dampers interconnected between B_i and B_j , and B_j and B_k , it can be obtained that

$$\frac{\partial \lambda_r}{\partial p} = - \begin{bmatrix} \boldsymbol{\varphi}_{i,r}^T & \boldsymbol{\varphi}_{j,r}^T & \boldsymbol{\varphi}_{k,r}^T \end{bmatrix} \begin{bmatrix} \lambda_r \frac{\partial C_{ii}}{\partial p} + \frac{\partial K_{ii}}{\partial p} & -\lambda_r \frac{\partial C_{ij}}{\partial p} - \frac{\partial K_{ij}}{\partial p} & \mathbf{0} \\ -\lambda_r \frac{\partial C_{ji}}{\partial p} - \frac{\partial K_{ji}}{\partial p} & \lambda_r \frac{\partial C_{jj}}{\partial p} + \frac{\partial K_{jj}}{\partial p} & -\lambda_r \frac{\partial C_{jk}}{\partial p} - \frac{\partial K_{jk}}{\partial p} \\ \mathbf{0} & -\lambda_r \frac{\partial C_{kj}}{\partial p} - \frac{\partial K_{kj}}{\partial p} & \lambda_r \frac{\partial C_{kk}}{\partial p} + \frac{\partial K_{kk}}{\partial p} \end{bmatrix} \begin{bmatrix} \boldsymbol{\varphi}_{i,r} \\ \boldsymbol{\varphi}_{j,r} \\ \boldsymbol{\varphi}_{k,r} \end{bmatrix} \quad (86)$$

If p is the position and orientation of spring-dampers interconnected between B_i and B_j , and B_k and B_l , it can be obtained that

$$\frac{\partial \lambda_r}{\partial p} = - \begin{bmatrix} \boldsymbol{\varphi}_{i,r}^T & \boldsymbol{\varphi}_{j,r}^T \end{bmatrix} \begin{bmatrix} \lambda_r \frac{\partial C_{ii}}{\partial p} + \frac{\partial K_{ii}}{\partial p} & -\lambda_r \frac{\partial C_{ij}}{\partial p} - \frac{\partial K_{ij}}{\partial p} \\ -\lambda_r \frac{\partial C_{ji}}{\partial p} - \frac{\partial K_{ji}}{\partial p} & \lambda_r \frac{\partial C_{jj}}{\partial p} + \frac{\partial K_{jj}}{\partial p} \end{bmatrix} \begin{bmatrix} \boldsymbol{\varphi}_{i,r} \\ \boldsymbol{\varphi}_{j,r} \end{bmatrix} - \begin{bmatrix} \boldsymbol{\varphi}_{k,r}^T & \boldsymbol{\varphi}_{l,r}^T \end{bmatrix} \begin{bmatrix} \lambda_r \frac{\partial C_{kk}}{\partial p} + \frac{\partial K_{kk}}{\partial p} & -\lambda_r \frac{\partial C_{kl}}{\partial p} - \frac{\partial K_{kl}}{\partial p} \\ -\lambda_r \frac{\partial C_{lk}}{\partial p} - \frac{\partial K_{lk}}{\partial p} & \lambda_r \frac{\partial C_{ll}}{\partial p} + \frac{\partial K_{ll}}{\partial p} \end{bmatrix} \begin{bmatrix} \boldsymbol{\varphi}_{k,r} \\ \boldsymbol{\varphi}_{l,r} \end{bmatrix} \quad (87)$$

The above-mentioned sensitivity formulations are based on the topology of the multibody systems. Particularly, eigen-sensitivity with respect to design parameters of mass and inertia, coefficients of stiffness and damping, position and orientation of connections are all derived analytically in detail. These results can be directly applied for sensitivity analysis of general mechanical systems and complex structures which are modelled as multibody systems.

5. Numerical examples and applications

5.1 Numerical verification

The computational efficiency for vibration calculation can be significantly improved by using the proposed method, in comparison with most of the traditional approaches. A multibody system with n rigid bodies and m DOFs is taken as an example to demonstrate it. Suppose there are p constraints for the open-loop system and q ($p \leq 6n - m \leq q$) constraints for the entire system. There are mainly four factors that can help to improve the computational efficiency.

1. Relative small scale of matrix computation. Traditionally, a matrix with size $(12n - m) \times (12n - m)$ must be generated and solved to obtain system matrices with size $m \times m$. In addition, in order to express the $6n - m$ dependent coordinates in terms of m independent coordinates, it is necessary to get the inverse of a matrix with size $6n - m$, according to the Kang's method (Kang et al., 2003). However, there are only matrices

M , C , K with size $6n \times 6n$ and an open-loop constraint matrix B' with size $6n \times (6n - p)$ need to be easily generated for the proposed method. And then a cut-joint constraint matrix B'' with size $(6n - p) \times m$ needs to be resolved to perform simple matrix multiplication for obtaining the final system matrices. In addition, there are only $6n - p - m$ dependent coordinates in terms of m independent coordinates, the size of matrix to be inverted is $6n - p - m$. It can be easily concluded that less computational efforts are required for the proposed method.

2. Reduction of trigonometric functions computing. Conventionally, the variations of coordinates and postures between two acting points of a connection, such as spring-damper or joint, are computed based on homogeneous transformation. Instead, the linear transformation in the proposed method can significantly reduce computational efforts due to calculation of trigonometric functions. Obviously, the more connections there are, the more computational efforts can be reduced.
3. Avoidance of complex calculation of Jacobian of constraint equation which usually contains many trigonometric functions. It is time-consuming for the calculation of Jacobian of a matrix with size $(6n - m) \times (6n - m)$. Instead, the constraint matrices B' and B'' can be easily obtained by using the presented definition of constraints for the proposed method.
4. Avoidance of linearization of nonlinear equations of motion. The ODEs generated by conventional methods are nonlinear ones that need to be linearized before perform vibration calculation (Cruz et al., 2007; Minaker & Frise, 2005; Negrut & Ortiz, 2006; Pott et al., 2007; Roy & Kumar, 2005). Instead, the ODEs obtained by using the proposed method are a minimal set of second-order linear ODEs which can be directly used for vibration calculation.

In this section, numerical experiments were carried out to verify the correctness and efficiency of the proposed method. It is unsuitable to compare straightforwardly the results of system matrices with theoretical solutions for they are usually very large in size. Normal mode analysis (NMA) and transfer function analysis (TFA) for the same model were performed in AMVA and commercial software ADAMS. The results of natural frequencies, the damping ratios, and the transfer function were compared to verify the correctness of the proposed method. Solution time was compared to testify the efficiency of the proposed method. The experiments were performed on a PC with CPU Pentium IV of 2.0 GHz and memory of 2.0 GB. Models with chain, tree, and closed-loop topology were taken as case studies, as shown in Fig. 6.

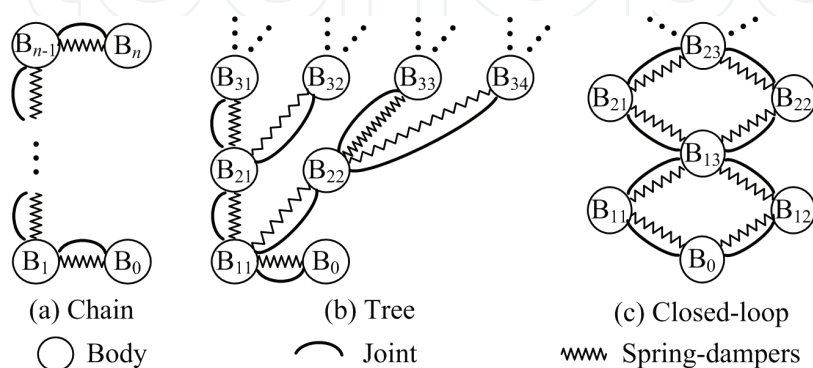

Fig. 6. Topologies of models used for numerical test

- A. Chain topology MBS. As shown in Fig. 6(a), n moving bodies and the ground B_0 are connected by joints and spatial spring-dampers in a chain. The position and orientation of CM of body B_i are $[0 \ 0 \ 0.2i-0.1 \ 0 \ 0 \ 0]$. The position and orientation of joint $J_{i-1,i}$ are $[0 \ 0 \ 0.2i-0.2 \ 0 \ 0 \ 0]$.
- B. Tree topology MBS. As shown in Fig. 6(b), the bodies are connected by joints and spatial spring-dampers in form of binary tree with N layers. There are $n_i = 2^{i-1}$ bodies in the i^{th} layer, among which the j^{th} one is denoted as B_{ij} . The position and orientation of CM of body B_{ij} are $[j \ i \ 0 \ 0 \ 0 \ 0]$. The position and orientation of joint between body $B_{i+1,2j-1}$ and B_{ij} are $[(3j-1)/2 \ i+0.5 \ 0 \ 0 \ 0 \ \text{arccot}(j-1)]$, and that between body $B_{i+1,2j}$ and B_{ij} are $[3j/2 \ i+0.5 \ 0 \ 0 \ 0 \ \text{arccot}(j)]$.
- C. Closed-loop topology MBS. As shown in Fig. 6(c), the bodies are connected by joints and spatial spring-dampers in form of ladder with N layers. There are three bodies in the i^{th} layer, among which the j^{th} one is denoted as B_{ij} . The position and orientation of CM of B_{ij} are $[0.2j-0.3 \ 0.2i-0.1 \ 0 \ 0 \ 0 \ 0]$ (for $j=1,2$) or $[0 \ 0.2i \ 0 \ 0 \ 0 \ \pi/2]$ (for $j=3$). The position and orientation of joint between $B_{i,3}$ and $B_{i,u}$ ($u=1,2$) are $[0.2u-0.3 \ 0.2i-0.1 \ 0 \ 0 \ 0 \ 0]$. The position and orientation of joint between $B_{i,3}$ and $B_{i+1,u}$ ($u=1,2$) are $[0.2u-0.3 \ 0.2i+0.1 \ 0 \ 0 \ 0 \ 0]$.

The rule of name for each kind of models is specified as follows. The first letter, i.e., 'C', 'T', and 'L', means model with chain, tree, and closed-loop topology, respectively. It then follows the number of bodies (for models with chain topology) or layers (for models with tree or closed-loop topology). The letter before 'F' means the type of joint in the model, e.g., 'R', 'P', 'C' and 'S' means revolute, prismatic, cylindrical and spherical joint. The figure at the end means the number of spring-dampers between two bodies connected by joint.

For simplicity without loss of generality, the mass and inertia tensor of all bodies, the stiffness and damping coefficients of all spring-dampers, as well as the position and orientation of joint and spring-dampers between each two bodies were set to be equal to each other, as specified in Table 2, where s is the number of spring-dampers between the two bodies considered.. The results of NMA and TFA (force input at CM of body $B_{6,1}$ in X-direction, displacement output at CM of body $B_{6,32}$ in Y-direction) for model TL7SF1 are shown in Fig.7 and Fig.8, respectively.

Parameter	Symbol	Value
Mass (kg)	m	1.0
Inertia ($\text{kg} \cdot \text{m}^2$)	$[I_{xx} \ I_{yy} \ I_{zz} \ I_{xy} \ I_{xz} \ I_{yz}]$	$[1.0 \ 1.0 \ 1.0 \ 0 \ 0 \ 0]$
Stiffness ($\text{N} \cdot \text{m}^{-1}$)	$[k_x^k \ k_y^k \ k_z^k]$	$[1.0 \ 1.0 \ 1.0] \times 10^4 / s$
Torsion stiffness ($\text{N} \cdot \text{m} \cdot \text{deg}^{-1}$)	$[k_\alpha^k \ k_\beta^k \ k_\gamma^k]$	$[1.0 \ 1.0 \ 1.0] \times 10^4 / s$
Damping ($\text{N} \cdot \text{s} \cdot \text{m}^{-1}$)	$[c_x^k \ c_y^k \ c_z^k]$	$[1.0 \ 1.0 \ 1.0] \times 10^1 / s$
Torsion damping ($\text{N} \cdot \text{m} \cdot \text{s} \cdot \text{deg}^{-1}$)	$[c_\alpha^k \ c_\beta^k \ c_\gamma^k]$	$[1.0 \ 1.0 \ 1.0] \times 10^1 / s$

Table 3. Parameters of bodies and spring-dampers in all case studies

Solutions in Fig.7 indicate that the results of eigenvalue calculated using AMVA are identical to those in ADAMS. The mean and maximal errors of natural frequencies between the two groups of results are 1.02×10^{-6} Hz and 5.00×10^{-5} Hz. The mean and maximal errors of damping ratios of the two groups of results are 1.73×10^{-10} and 5.00×10^{-8} . Comparisons in

Fig.8 indicate that solutions of transfer function calculated using AMVA coincide well with those in ADAMS.

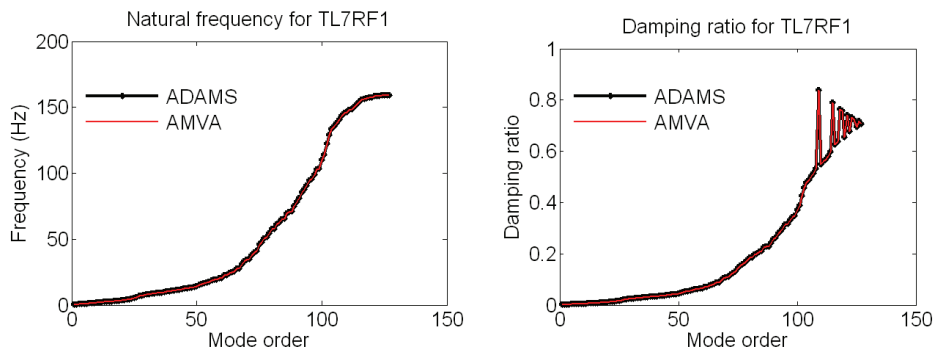

Fig. 7. Comparison of NMA results for model TL7RF1

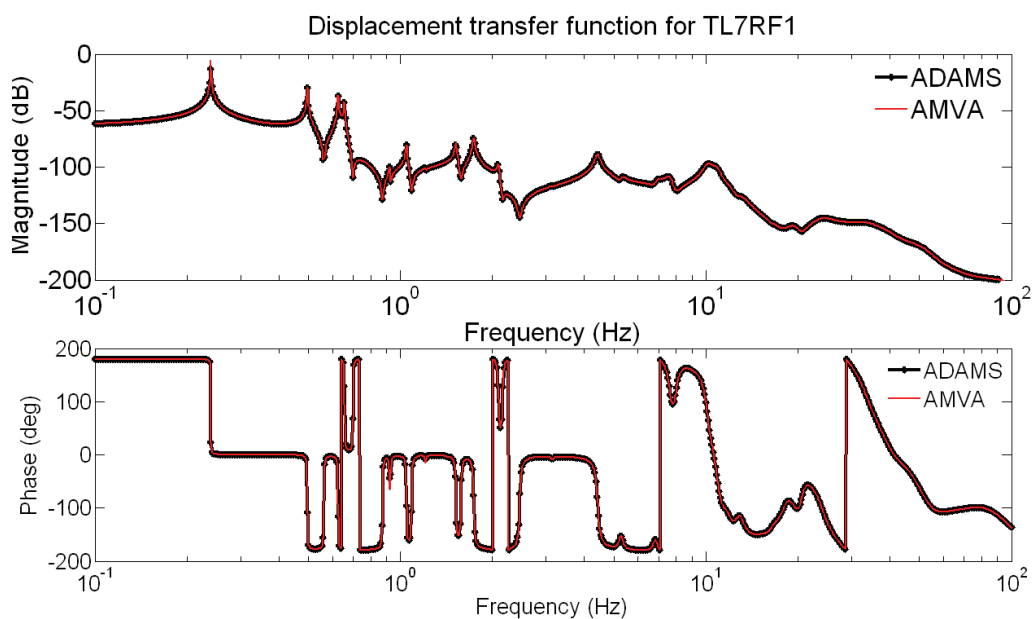

Fig. 8. Comparison of TFA solutions for model TL7RF1

5.2 Applications in engineering

A quadruped robot and a Stewart platform were taken as case studies to verify the effectiveness of the proposed method for both open-loop and closed-loop spatial mechanism systems, respectively. Simulations and experiments were further carried out on a wafer stage to justify the presented method.

a. Quadruped robot

The proposed method has been applied in linear vibration analysis of a quadruped robot, which is an open-loop spatial mechanism system. As shown in Fig. 9, the body is connected with four legs via revolute joints along z direction. Each leg consists of three parts which are connected by two turbine worm gears. The leg mechanism can be modeled as three rigid bodies connected by two revolute joints and torsion springs along x direction. Each flexible foot is modeled as a three dimensional linear spring-damper, then the quadruped robot becomes an open-loop spatial mechanism system with 13 bodies and 18 DOFs.

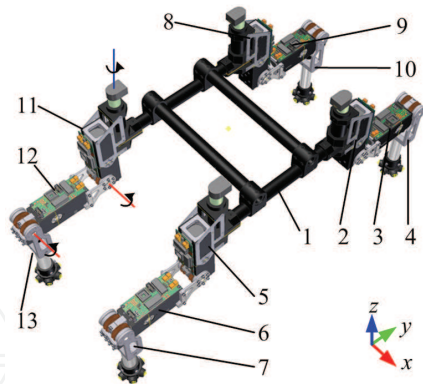

Fig. 9. Quadruped robot

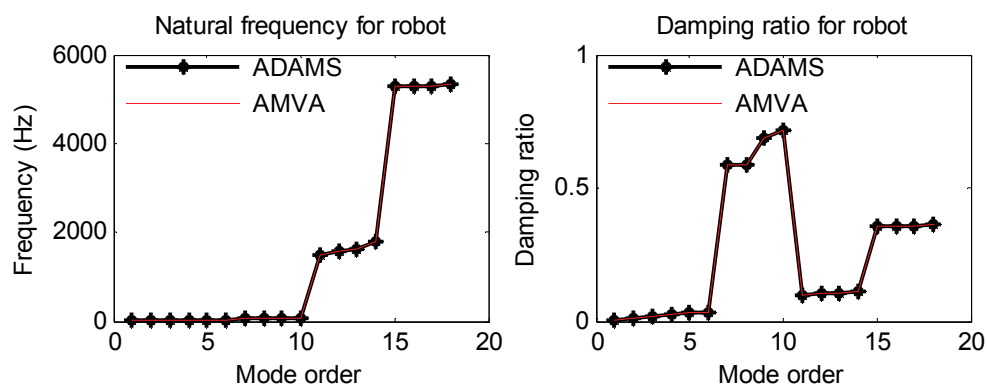

Fig. 10. Comparison of NMA results for quadruped robot

Normal mode analysis and transfer function analysis were both performed in ADAMS and AMVA for such a quadruped robot. As shown in Fig. 10, natural frequencies and damping ratio solved in two tools are equal to each other. Fig. 11 shows that results of transfer function computed in two packages are identical. It indicates that dynamic analysis of open-loop spatial mechanism system can also be solved using the proposed method.

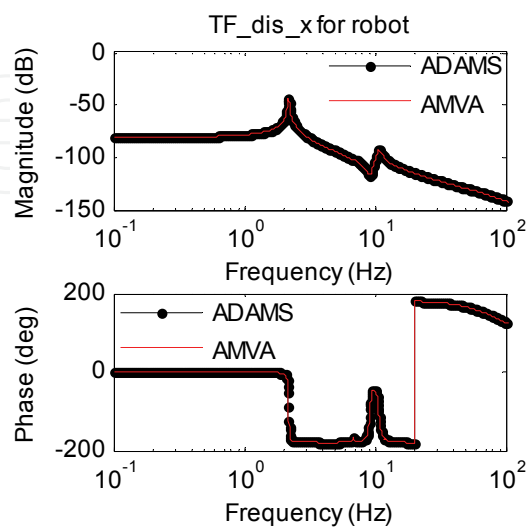

Fig. 11. Comparison of TFA results for quadruped robot

b. Stewart platform

The proposed method has also been applied in linear vibration analysis of a Stewart isolation platform, which is a closed-loop spatial mechanism system with six parallel linear actuators, as shown in Fig. 12. The isolated platform on the top layer is connected with linear actuators via flexible joints. The lower end of each actuator is also connected with the base via flexible joint. Based on previous finite element analysis, each flexible joint is modeled as spherical joint together with three-dimensional torsion spring-damper. And each linear actuator is modeled as two rigid bodies connected with a translational joint together with a linear spring-damper along the relative moving direction. Therefore the system can be modeled as a closed-loop spatial mechanism system with 14 rigid bodies and 12 DOFs.

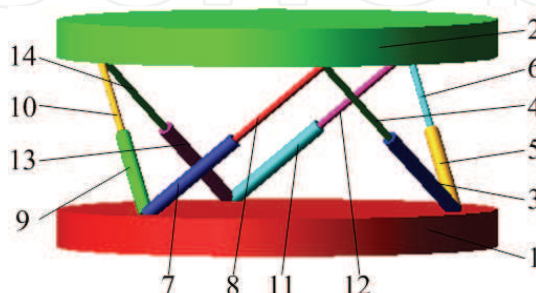

Fig. 12. Stewart platform

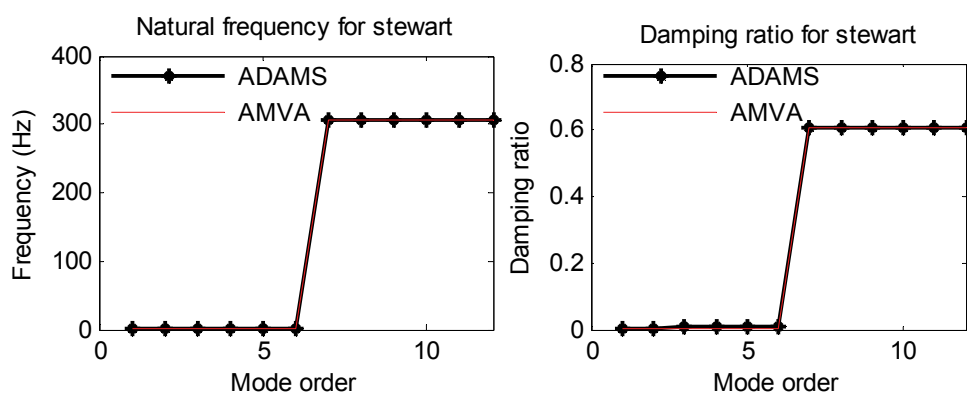

Fig. 13. Comparison of NMA results for Stewart platform

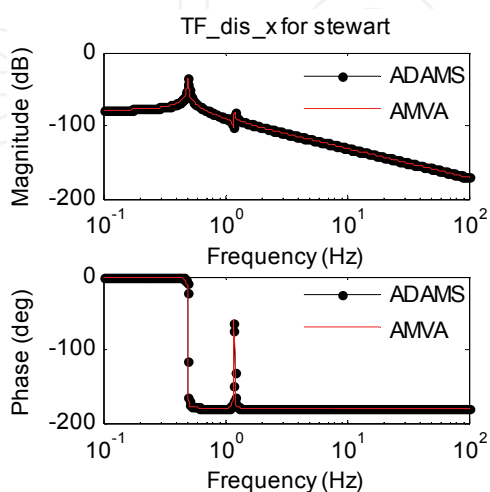

Fig. 14. Comparison of TFA results for Stewart platform

Normal mode analysis and transfer function analysis were both performed in ADAMS and AMVA to acquire vibration isolation performance of such a Stewart platform. As shown in Fig. 13, natural frequencies and damping ratio solved in two tools are equal to each other. Fig. 14 shows that results of transfer function of displacement computed in two packages are identical. Fig. 15 shows that results of time response of displacement computed in two packages are identical. It indicates that dynamic analysis of closed-loop spatial mechanism system can also be solved using the proposed method.

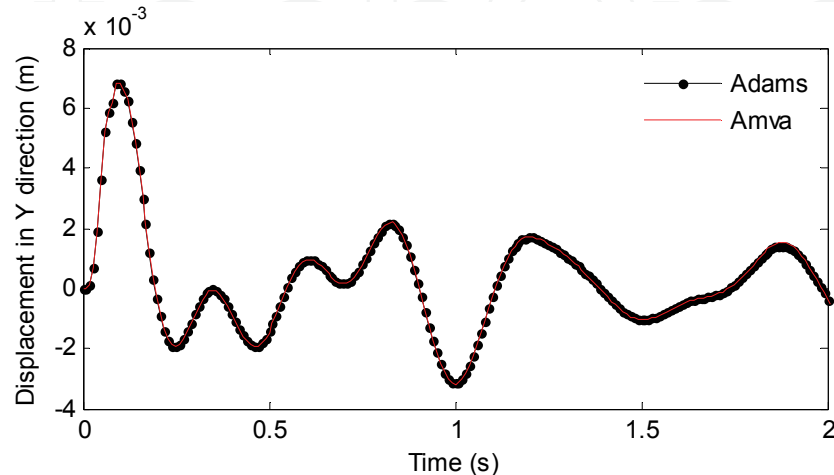

Fig. 15. Comparison of TRA solutions for the Stewart platform

7. Conclusion

A new formulation based on constraint-topology transformation is proposed to generate oscillatory differential equations for a general multibody system. Vibration displacements of bodies are selected as generalized coordinates. The translational and rotational displacements are integrated in spatial notation. Linear transformation of vibration displacements between different points on the same rigid body is derived. Absolute joint displacement is introduced to give mathematical definition for ideal joint in a new form. Constraint equations written in this way can be solved easily via the proposed linear transformation. The oscillatory differential equations for a general multibody system are derived by matrix generation and quadric transformation in three steps:

1. Linearized ODEs in terms of absolute displacements are firstly derived by using Lagrangian method for free multibody system without considering any constraint.
2. An open-loop constraint matrix is derived to formulate linearized ODEs via quadric transformation for open-loop multibody system, which is obtained from closed-loop multibody system by using cut-joint method.
3. A cut-joint constraint matrix corresponding to all cut-joints is finally derived to formulate a minimal set of ODEs via quadric transformation for closed-loop multibody system.

Sensitivity of the mass, stiffness and damping matrix about each kind of design parameters are derived based on the proposed algorithm for vibration calculation. The results show that they can be directly obtained by matrix generation and multiplication without derivatives. Eigen-sensitivity about design parameters are then carried out.

Several kinds of mechanical systems are taken as case studies to illustrate the presented method. The correctness of the proposed method has been verified via numerical

experiments on multibody system with chain, tree, and closed-loop topology. Results show that the vibration calculation and sensitivity analysis have been greatly simplified because complicatedly solving for constraints, linearization and derivatives are unnecessary. Therefore the proposed method can be used to greatly improve the computational efficiency for vibration calculation and sensitivity analysis of large-scale multibody system. Sensitivity of the dynamic response with respect to the design parameters, and the computational efficiency of the proposed method will be investigated in the future.

8. References

- Amirouche, F., (2006). *Fundamentals of multibody dynamics: theory and applications*, Birkhauser, 9780817642365, Boston
- Anderson, KS & Hsu, Y., (2002). Analytical Fully-Recursive Sensitivity Analysis for Multibody Dynamic Chain Systems, *Multibody Syst. Dyn.*, Vol. 8, No. 1, (1-27), 1384-5640
- Attia, HA, (2008). Modelling of three-dimensional mechanical systems using point coordinates with a recursive approach, *Appl. Math. Model.*, Vol. 32, No. 3, (315-326), 0307-904X
- Choi, KM, Jo, HK, Kim, WH, et al., (2004). Sensitivity analysis of non-conservative eigensystems, *J. Sound Vib.*, Vol. 274, (997-1011), 0022-460X
- Cruz, HD, Biscay, RJ, Carbonell, F., et al., (2007). A higher order local linearization method for solving ordinary differential equations, *Appl. Math. Comput.*, Vol. 185, No. 1, (197-212), 0096-3003
- Ding, JY, Pan, ZK & Chen, LQ, (2007). Second order adjoint sensitivity analysis of multibody systems described by differential-algebraic equations, *Multibody Syst. Dyn.*, Vol. 18, (599-617), 1384-5640
- Eberhard, P. & Schiehlen, W., (2006). Computational dynamics of multibody systems: history, formalisms, and applications, *J. Comput. Nonlin. Dyn.*, Vol. 1, (3-12), 1555-1415
- Flores, P., Ambrósio, J., Claro, P., et al., (2008). *Kinematics and dynamics of multibody systems with imperfect joints: models and case studies*, Springer-Verlag, 9783540743590, Berlin
- Jiang, W., Chen, XD & Yan, TH, (2008a). Symbolic formulation of multibody systems for vibration analysis based on matrix transformation, *Chinese J. Mech. Eng. (Chinese Ed.)*, Vol. 44, No. 6, (54-60), 0577-6686
- Jiang, W., Chen, XD, Luo, X. & Huang, QJ, (2008b). Symbolic formulation of large-scale open-loop multibody systems for vibration analysis using absolute joint coordinates, *JSME J. Syst. Design Dyn.*, Vol. 2, No. 4, (1015-1026), 1881-3046
- Kang, JS, Bae S., Lee JM & Tak TO, (2003). Force equilibrium approach for linearization of constrained mechanical system dynamics, *ASME J. Mech. Design*, Vol. 125, (143-149), 1050-0472
- Laulusa, A. & Bauchau, OA, (2008). Review of classical approaches for constraint enforcement in multibody Systems, *J. Comput. Nonlin. Dyn.*, Vol. 3, No. 1, (011004), 1555-1415
- Lee, IW, Kim, DO & Jung, GH, (1999a). Natural frequency and mode shape sensitivities of damped systems: part i, distinct natural frequencies, *J. Sound Vib.*, Vol. 223, No. 3, (399-412), 0022-460X
- Lee, IW, Kim, DO & Jung, GH, (1999). Natural frequency and mode shape sensitivities of damped systems: part ii, multiple natural frequencies, *J. Sound Vib.*, Vol. 223, No. 3, (413-424), 0022-460X

- Liu, JY, Hong, JZ & Cui, L., (2007). An exact nonlinear hybrid-coordinate formulation for flexible multibody systems, *Acta Mech. Sinica*, Vol. 23, No. 6, (699-706), 0567-7718
- McPhee, JJ & Redmond, SM, (2006). Modelling multibody systems with indirect coordinates, *Comput. Method. Appl. Mech. Eng.*, Vol. 195, No. 50-51, (6942-6957), 0045-7825
- Minaker, B. & Frise, P., (2005). Linearizing the equations of motion for multibody systems using an orthogonal complement method, *J. Vib. Control*, Vol. 11, (51-66), 1077-5463
- Müller, A., (2004). Elimination of redundant cut joint constraints for multibody system models, *ASME J. Mech. Design*, Vol. 126, No. 3, (488-494), 1050-0472
- Negrut, D. & Ortiz, JL, (2006). A practical approach for the linearization of the constrained multibody dynamics equations, *J. Comput. Nonlin. Dyn.*, Vol. 1, No. 3, (230-239), 1555-1415
- Pott, A., Kecskeméthy, A., Hiller, M., (2007). A simplified force-based method for the linearization and sensitivity analysis of complex manipulation systems, *Mech. Mach. Theory*, Vol. 42, No. 11, (1445-1461), 0094-114X
- Richard, MJ, McPhee, JJ & Anderson, RJ, (2007). Computerized generation of motion equations using variational graph-theoretic methods, *Appl. Math. Comput.*, Vol. 192, No. 1, (135-156), 0096-3003
- Roy, D. & Kumar, R., (2005). A multi-step transversal linearization (MTL) method in non-linear structural dynamics, *J. Sound Vib.*, Vol. 287, No. 1-2, (203-226), 0022-460X
- Rui, XT, Wang, GP, Lu, YQ, et al., (2008). Transfer matrix method for linear multibody system, *Multibody Syst. Dyn.*, Vol. 19, No. 3, (179-207), 1384-5640
- Schiehlen, W., Guse, N. & Seifried, R., (2006). Multibody dynamics in computational mechanics and engineering applications, *Comput. Method Appl. Mech. Eng.*, Vol. 195, No. 41-43, (5509-5522), 0045-7825
- Sliva, G., Brezillon, A., Cadou, JM, et al., (2010). A study of the eigenvalue sensitivity by homotopy and perturbation methods, *J. Computat. Appl. Math.*, Vol. 234, No. 7, (2297-2302), 0377-0427
- Sohl, GA & Bobrow, JE, (2001). A Recursive Multibody Dynamics and Sensitivity Algorithm for Branched Kinematic Chains, *ASME J. Dyn. Syst. Meas. Control*, Vol. 123, (391-399), 0022-0434
- Valasek, M., Sika, Z. & Vaculin, O., (2007). Multibody formalism for real-time application using natural coordinates and modified state space, *Multibody Syst. Dyn.*, Vol. 17, No. 2, (209-227), 1384-5640
- Van Keulen, F., Haftk, RT & Kim, NH, (2005). Review of options for structural design sensitivity analysis. part 1: linear systems, *Comput. Methods Appl. Mech. Eng.*, Vol. 194, (3213-3243), 0045-7825
- Wasfy, TM & Noor, AK, (2003). Computational strategies for flexible multibody systems, *Appl. Mech. Rev.*, Vol. 56, No. 6, (553-613), 0003-6900
- Wittbrodt, E., Adamiec-Wójcik, I. & Wojciech, S., (2006). *Dynamics of flexible multibody systems: rigid finite element method*, Springer-Verlag, 9783540323518, Berlin
- Wittenburg, J., (2008). *Dynamics of multibody systems*, Springer-Verlag, 9780521850117, Berlin
- Xu, ZH, Zhong, HX, Zhu, XW, et al., (2009). An efficient algebraic method for computing eigensolution sensitivity of asymmetric damped systems, *J. Sound Vib.*, Vol. 327, (584-592), 0022-460X

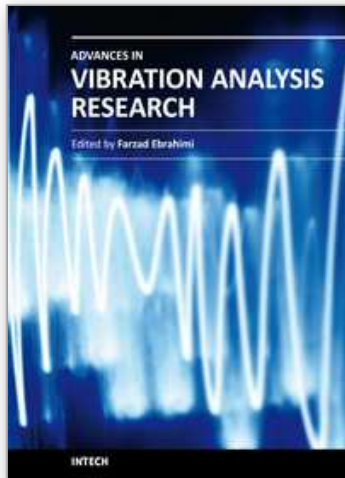

Advances in Vibration Analysis Research

Edited by Dr. Farzad Ebrahimi

ISBN 978-953-307-209-8

Hard cover, 456 pages

Publisher InTech

Published online 04, April, 2011

Published in print edition April, 2011

Vibrations are extremely important in all areas of human activities, for all sciences, technologies and industrial applications. Sometimes these Vibrations are useful but other times they are undesirable. In any case, understanding and analysis of vibrations are crucial. This book reports on the state of the art research and development findings on this very broad matter through 22 original and innovative research studies exhibiting various investigation directions. The present book is a result of contributions of experts from international scientific community working in different aspects of vibration analysis. The text is addressed not only to researchers, but also to professional engineers, students and other experts in a variety of disciplines, both academic and industrial seeking to gain a better understanding of what has been done in the field recently, and what kind of open problems are in this area.

How to reference

In order to correctly reference this scholarly work, feel free to copy and paste the following:

Wei Jiang, Xuedong Chen and Xin Luo (2011). Vibration and Sensitivity Analysis of Spatial Multibody Systems Based on Constraint Topology Transformation, *Advances in Vibration Analysis Research*, Dr. Farzad Ebrahimi (Ed.), ISBN: 978-953-307-209-8, InTech, Available from: <http://www.intechopen.com/books/advances-in-vibration-analysis-research/vibration-and-sensitivity-analysis-of-spatial-multibody-systems-based-on-constraint-topology-transfo>

INTECH
open science | open minds

InTech Europe

University Campus STeP Ri
Slavka Krautzeka 83/A
51000 Rijeka, Croatia
Phone: +385 (51) 770 447
Fax: +385 (51) 686 166
www.intechopen.com

InTech China

Unit 405, Office Block, Hotel Equatorial Shanghai
No.65, Yan An Road (West), Shanghai, 200040, China
中国上海市延安西路65号上海国际贵都大饭店办公楼405单元
Phone: +86-21-62489820
Fax: +86-21-62489821

© 2011 The Author(s). Licensee IntechOpen. This chapter is distributed under the terms of the [Creative Commons Attribution-NonCommercial-ShareAlike-3.0 License](#), which permits use, distribution and reproduction for non-commercial purposes, provided the original is properly cited and derivative works building on this content are distributed under the same license.

IntechOpen

IntechOpen