

# We are IntechOpen, the world's leading publisher of Open Access books Built by scientists, for scientists

4,800

Open access books available

122,000

International authors and editors

135M

Downloads

Our authors are among the

154

Countries delivered to

TOP 1%

most cited scientists

12.2%

Contributors from top 500 universities



WEB OF SCIENCE™

Selection of our books indexed in the Book Citation Index  
in Web of Science™ Core Collection (BKCI)

Interested in publishing with us?  
Contact [book.department@intechopen.com](mailto:book.department@intechopen.com)

Numbers displayed above are based on latest data collected.  
For more information visit [www.intechopen.com](http://www.intechopen.com)



# Pseudorandom Tag Arrangement for Accurate RFID based Mobile Robot Localization

Sungbok Kim and Hyunbin Kim

*Department of Digital Information Engineering*

*Hankuk University of Foreign Studies*

*Republic of Korea*

## 1. Introduction

The localization of a mobile robot is one key ingredient for autonomous navigation, along with map building and obstacle detection/avoidance (Borenstein, J., et al., 1996). Several sensors have long been used for mobile robot localization, but all of them are confronted with their own inherent limitations. Encoder suffers from error accumulation, ultrasonic/laser sensor demands the line of sight, camera expends complicated processing, and GPS works at low resolution. To cope with these problems of typical sensors, new attempts have been made, which use the RFID system consisting of tags, antenna, and reader for mobile robot localization (Finkenzeller, K., 2000).

There have been two different research groups of working on the RFID based mobile robot localization. Both groups assume that a set of tags storing the absolute positional information are deployed throughout a navigation environment. In one group, either active or passive tags are installed along the wall and they are used as beacons or landmarks to guide the navigation of a mobile robot (Kubitz, O., et al., 1997; Kantor, G., et al., 2002; Hahnel, D., et al., 2004; Kulyukin, V., et al., 2004; Penttila, K., et al., 2004; Yamano, K., et al., 2004; Kim, B.K., et al., 2006; Vorst, P., et al., 2008). However, in the other group, passive tags are installed on the floor and they are used to indicate the current position of a mobile robot (Bohn, J., et al., 2004; Choi, J., et al., 2006; Kim, B.K., et al., 2006; Han, S., et al., 2007; Kodaka, K., et al., 2008). This paper belongs to the latter group.

When an antenna senses a tag on the floor, there involves the positional uncertainty within the sensing range, which degrades the performance of RFID based mobile robot localization. One simple way of alleviating such a limitation may be to increase the tag distribution density on the floor. If more than one tag is sensed by an antenna at one instant, the current position of a mobile robot can be estimated more accurately by utilizing multiple tag readings (Han, S., et al., 2007; Kodaka, K., et al., 2008). However, the increased tag distribution density may be accompanied by the economical problem of high tag installation cost and the technical problem of incorrect tag readings.

For a given tag distribution density, the performance of RFID based mobile robot localization is affected by how a set of tags are arranged over the floor. There have been a variety of tag arrangements considered so far, which can be categorized into three repetitive arrangements, including square, parallelogram, and tilted square. Depending on the

localization method, the tag arrangement can be optimized for improved localization performance. It is claimed that the triangular pattern is optimal in (Han, S., et al, 2007).

In this paper, we present a pseudorandom RFID tag arrangement for improved performance of mobile robot localization. This paper is organized as follows. With the underlying assumptions, Section 2 describes a mobile robot localization method using spatial and temporal information. Section 3 examines four repetitive tag arrangements, including square, parallelogram, tilted square, and equilateral triangle, in terms of tag installation and tag invisibility. Inspired from the Sudoku puzzle, Section 4 proposes the pseudorandom tag arrangement for reduced tag invisibility without increased installation difficulty. Section 5 gives some experimental results. Finally, the conclusion is made in Section 6.

## 2. Mobile robot localization

In RFID based mobile robot localization, a mobile robot equipped with an antenna at the bottom navigates over the floor covered with a set of tags. As a mobile robot moves around, an antenna often senses tags that are located within the sensing range. For simplicity, let us assume that the sensing range of an antenna is circular and the shape of a tag is a point. For explanation, it is convenient to exchange the roles between antenna and tag, in such a way that a point shape antenna passes through the circular range of a sensed tag. This is illustrated in Fig. 1.

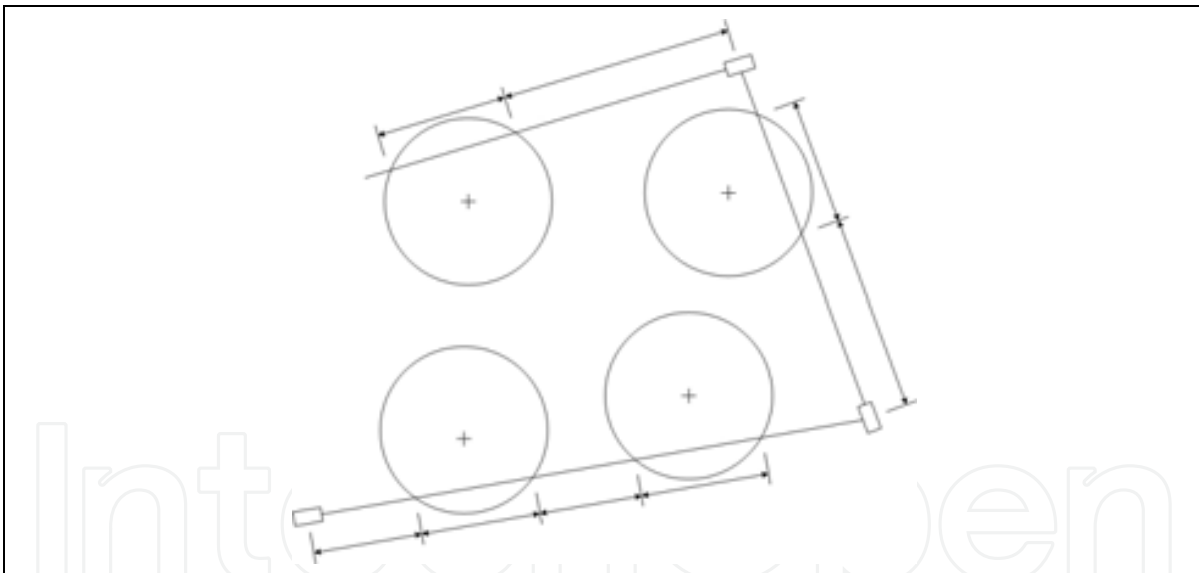

Fig. 1. Mobile robot trajectory over the floor covered with tags

The number of tags sensed by an antenna at one instant is assumed to be either one or zero. This assumption of low tag distribution density will be valid especially for lower end personal/ service robots in home/ office environments. Next, a mobile robot is assumed to travel along a trajectory consisting of a series of linear segments, as shown in Fig. 1. For each linear segment, a mobile robot standing still at the beginning changes the steering angle, then forwards at a constant speed, and finally stops at the end. It is also assumed that a mobile robot moves at a human walking speed, so that the time required for self-rotation or acceleration/ deceleration is negligible compared with the constant speed line traveling time along the linear segment.

## 2.1 Velocity estimation

Fig. 2 depicts the situation where a mobile robot initially standing at a priori known position moves straight across the sensing range of a tag at a constant speed. Let us consider the mobile robot localization under this situation, which is effective for all but first linear segment. Suppose that a pair of temporal information on the traverse of a mobile robot across the sensing range are given: the elapse time from starting to entering and the elapse time from entering and exiting. Given these two timing information, the velocity of a mobile robot, that is, the steering angle and the forwarding speed, can be determined. Note that there are two constraints for two unknowns.

For convenience, the local coordinate system is introduced, in such a way that the tag position is defined as the coordinate origin,  $O = [0 \ 0]^T$ , and the starting position is defined at  $A = [-l \ 0]^T$ , as shown in Fig. 2. Let  $r$  be the radius of the circular sensing range centered at a tag. Let  $t_1$  be the elapse time during which a mobile robot starts to move and then reaches the sensing range. Let  $t_2$  be the elapse time during which a mobile robot enters into the sensing range and then exits out of it. Let  $\theta (= \angle OAB)$  be the steering angle of a mobile robot, and  $v$  be the forwarding speed along the linear segment. Let us denote  $OA = l$ ,  $OB = OC = r$ ,  $OF = c$ ,  $AB = a (= vt_1)$ , and  $BC = b (= vt_2)$ .

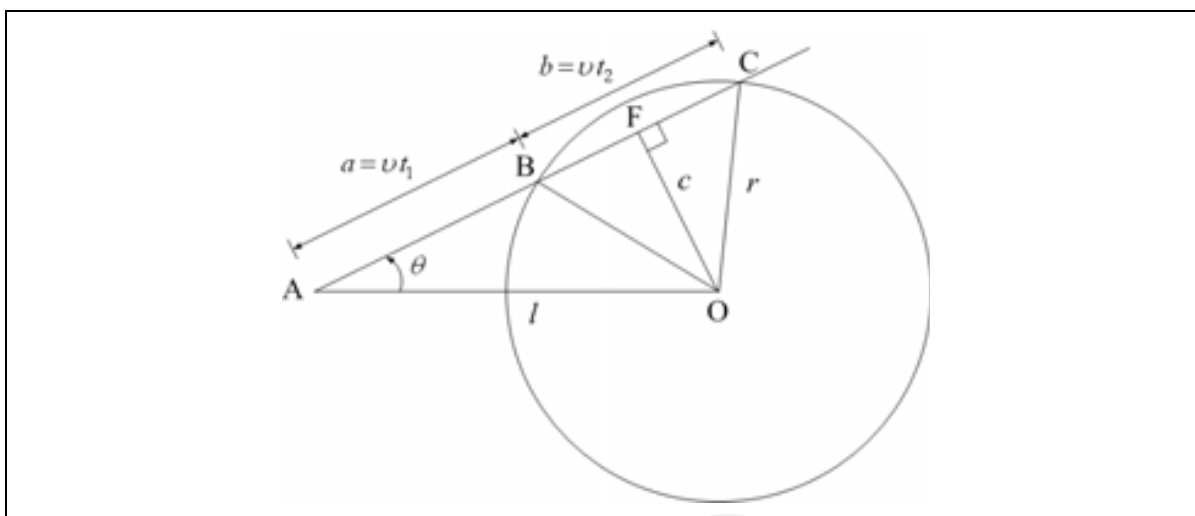

Fig. 2. Mobile robot traversing across tag sensing range

First, from  $\triangle OAF$  and  $\triangle OBF$ , using Pythagoras' theorem,

$$l^2 = c^2 + \left(a + \frac{b}{2}\right)^2 \quad (1)$$

$$r^2 = c^2 + \left(\frac{b}{2}\right)^2 \quad (2)$$

From (1) and (2), we can have

$$a(a + b) = l^2 - r^2 \quad (3)$$

so that the forwarding speed,  $v$ , of a mobile robot can be obtained by

$$v^2 = \frac{l^2 - r^2}{(t_1 + t_2)t_1} \quad (4)$$

where  $a = vt_1$  and  $b = vt_2$  are used.

Once  $v$  is known using (4), applying the law of cosines to  $\Delta OAB$ , the steering angle,  $\theta$ , of a mobile robot can be determined:

$$\cos\theta = \frac{(vt_1)^2 + l^2 - r^2}{2(vt_1)l} \quad (5)$$

which leads to

$$\theta = \text{atan2}(\pm\sqrt{1 - \cos^2\theta}, \cos\theta) \quad (6)$$

Seen from (6), there are two solutions of  $\theta$ , which are illustrated in Fig. 3. Although both solutions are mathematically valid, only one of them can be physically true as the velocity of a mobile robot. This solution duplicity should be resolved to uniquely determine the velocity of a mobile robot. One way of resolving the solution duplicity is to utilize the information from the encoders that are readily available. For instance, the estimated steering angle using the encoder readings can be used as the reference to choose the true solution out of two possible solution.

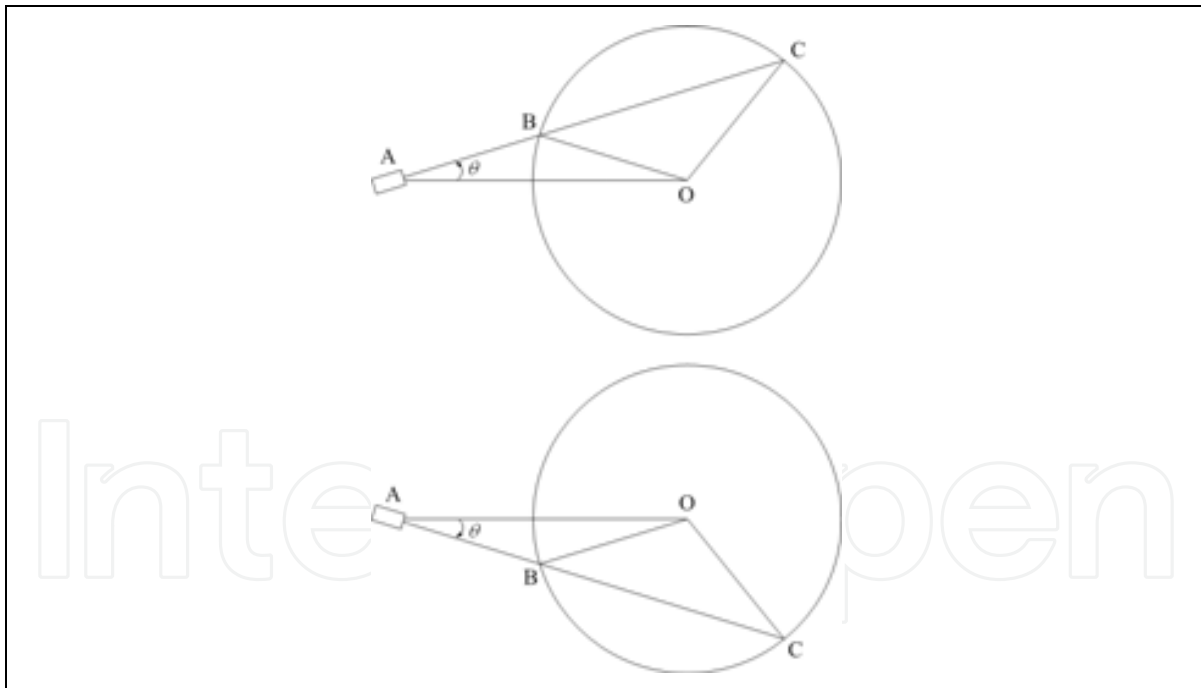

Fig. 3. Solution duplicity of mobile robot velocity

Let us briefly discuss the case where the starting position of a mobile robot is not known a priori, which is true for the first linear segment, that is, at the start of navigation. Now, there are four unknowns: two for the starting position and two for the velocity, which implies that four constraints are required. One simple way of providing four constraints is to command a mobile robot to move straight at a constant speed across the sensing ranges of two tags, as shown in Fig. 4. The detailed procedure will be omitted in this paper, due to space limit.

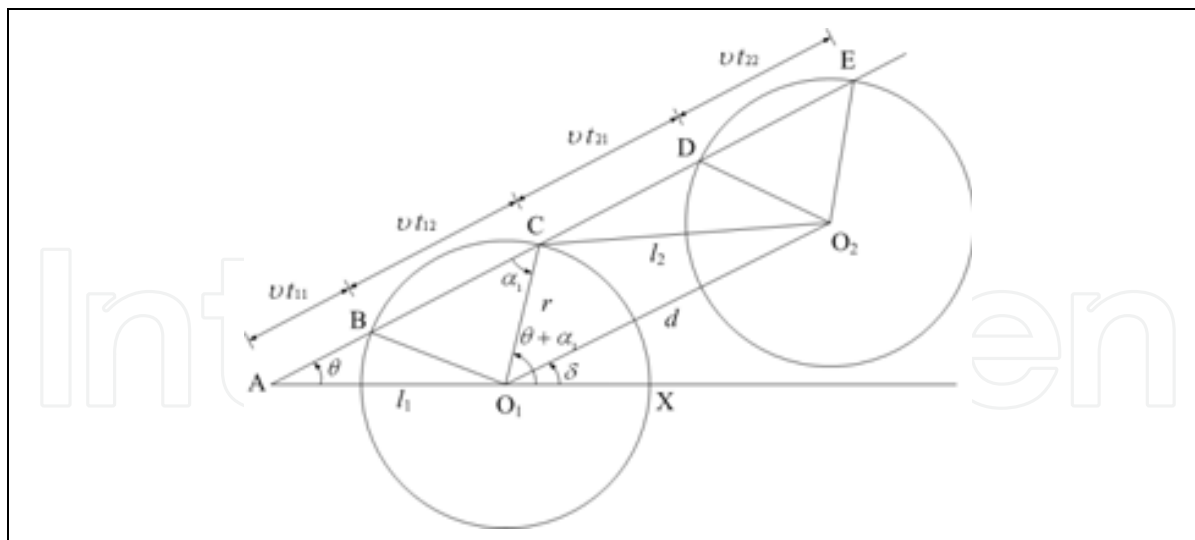

Fig. 4. Velocity estimation for the first linear segment

## 2.2 Position estimation

At each sampling instant, the current position of a mobile robot will be updated using the velocity information obtained at the previous sampling instant. Unfortunately, this implies that the RFID based mobile robot localization proposed in this paper suffers from the positional error accumulation, like a conventional encoder based localization. However, in the case of RFID based localization, the positional error does not keep increasing over time but is reduced to a certain bound at each tag traversing. Under a normal floor condition, RFID based localization will work better than encoder based localization in term of positional uncertainty, while the reverse is true in terms of positional accuracy.

## 3. Repetitive tag arrangements

The performance of RFID based mobile robot localization is heavily dependent on how densely tags are distributed over the floor and how they are arranged over the floor. As the tag distribution density increases, more tag readings can be used for mobile robot localization, leading to better accuracy of localization. However, the increased tag distribution density may cause the economical problem of excessive tag installation cost as well as the technical problem of duplicated tag readings.

For a given tag distribution density, the tag arrangement over the floor affects the performance of RFID based mobile robot localization. Several tag arrangements have been considered so far, however, they can be categorized into four repetitive arrangements, including square, parallelogram, tilted square, and equilateral triangle. For a given tag distribution density, it is claimed that the tag arrangement can be optimized for improved mobile robot localization, which depends on the localization method used (Han, S., et al., 2007; Choi, J., et al., 2006).

### 3.1 Tag installation

One important consideration in determining the tag arrangement should be how easily a set of tags can be installed over the floor. Practically, it is very difficult or almost impossible to precisely attach many tags right on their respective locations one by one. To alleviate the

difficulty in tag installation, two step procedure can be suggested. First, attach each group of tags on a square or rectangular tile in a designated pattern. Then, place the resulting square tiles on the floor in a certain repetitive manner.

First, consider the case in which a group of four tags are placed on a square tile of side length of  $2s(\geq 4r)$ , where  $r$  is the radius of the circular tag sensing range, under the restriction that all four sensing ranges lie within a square tiles without overlapping among them. Note that the maximum number of tags sensed at one instant is assumed to be one in this paper. Fig. 5 shows three square tag patterns, including square, parallelogram, and tilted square. Fig. 5a) shows the square pattern, where four tags are located at the centers of four quadrants of a square tile.

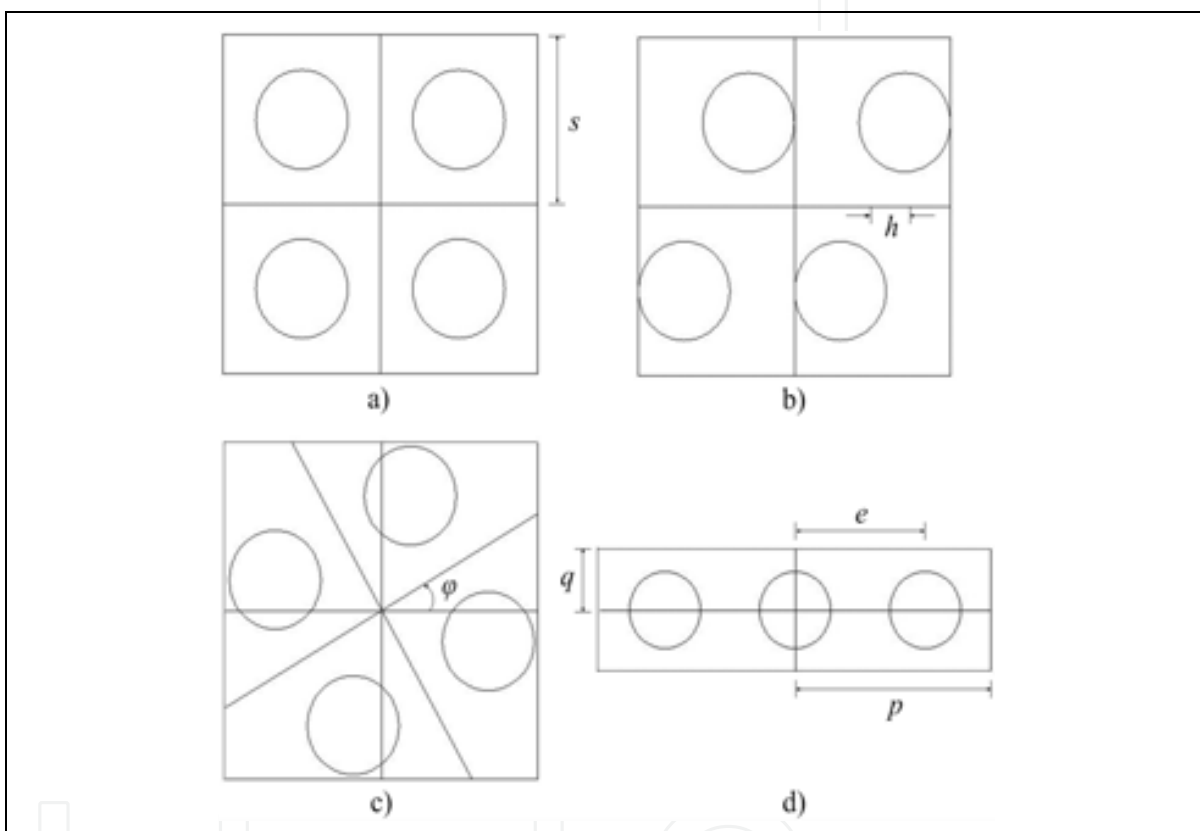

Fig. 5. Four tag patterns: a) square, b) parallelogram, c) tilted square, and d) line

Fig. 5b) shows the parallelogram pattern, which can be obtained from the square pattern shown in Fig. 5a) by shifting upper two tags to the right and lower two tags to the left, respectively. The degree of slanting, denoted by  $h$ , is the design parameter of the parallelogram pattern. In the case of  $h = \frac{s}{4}$ , the parallelogram pattern becomes an isosceles triangular pattern (Han, S., et al., 2007). And, in the case of  $h = 0$ , the parallelogram pattern reduces to the square pattern.

Fig. 5c) shows the tilted square pattern (Choi, J., et al., 2006), which can be obtained by rotating the square pattern shown in Fig. 5a). The angle of rotation, denoted by  $\varphi$ , is the design parameter of the tilted square pattern. Note that the tilted square pattern returns to the square pattern in the case of  $\varphi = 0, \frac{\pi}{2}$ .



Next, consider the case in which a group of three tags are placed in a line on a rectangular tile of side lengths of  $2p (\geq 6r)$  and  $2q (\geq 2r)$ , under the same restriction imposed on three square tag patterns above. Fig. 5d) shows the line tag pattern. For later use in equilateral triangular pattern generation, we set

$$\begin{aligned} 2p &= 3e \\ 2q &= \frac{\sqrt{3}}{2}e \end{aligned} \quad (7)$$

where  $e$  denotes the tag spacing, that is, the distance between two adjacent tags. For the line pattern to have the same tag distribution density as three square patterns,

$$4s^2 : 4pq = 4 : 3 \quad (8)$$

From (7) and (8), it can be obtained that

$$e^2 = \frac{2}{\sqrt{3}}s^2 \quad (9)$$

Fig. 6 shows four different tag arrangements, each of which results from placing the corresponding tag pattern in a certain repetitive manner.

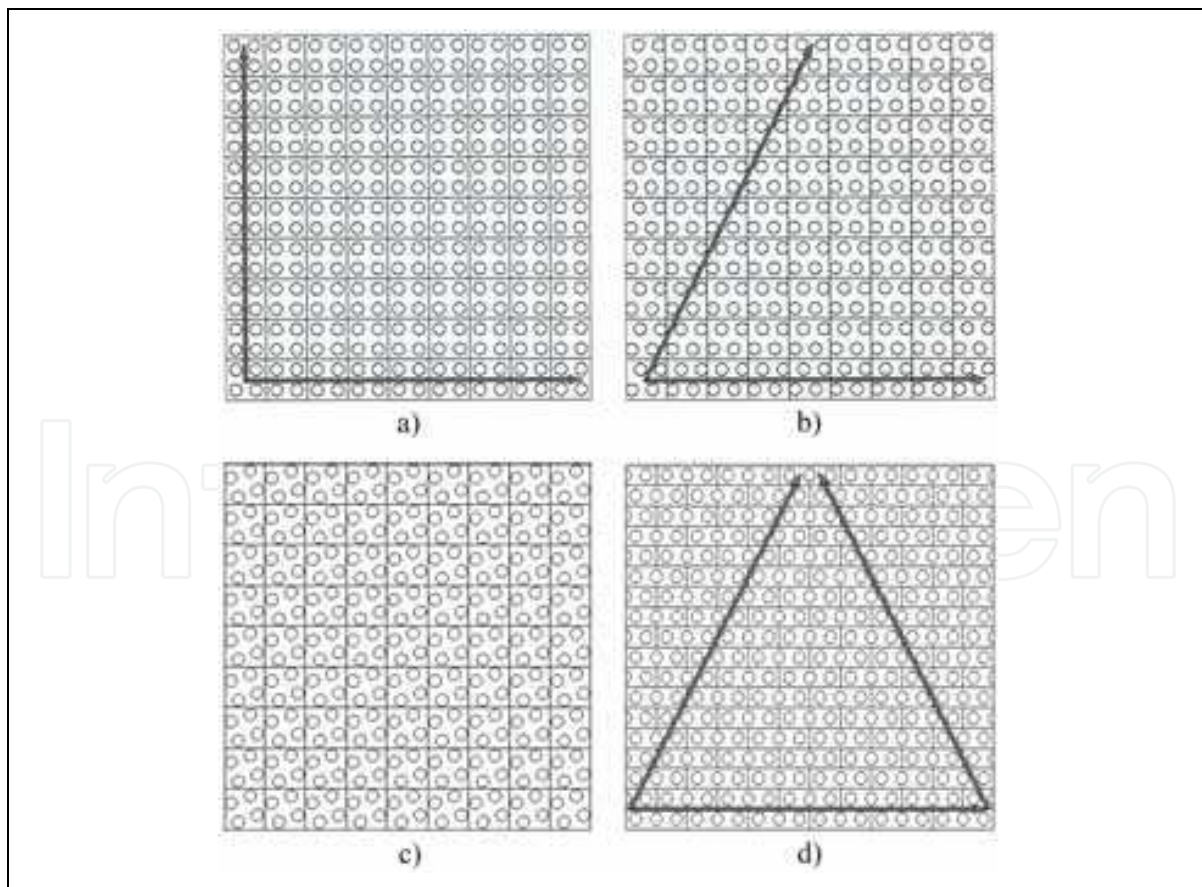

Fig. 6. Four repetitive tag arrangements: a) square, b) parallelogram, c) tilted square, and d) equilateral triangle



### 3.2 Tag invisibility

In RFID based mobile robot localization, it may happen that an antenna cannot have a chance to sense any tag during navigation, referred here to as the tag invisibility. If the tag invisibility persists for a long time, it may lead a mobile robot astray, resulting in the failure of RFID based localization. The tag invisibility should be one critical factor that needs to be taken into account in determining the tag arrangement. For a given tag distribution density, it will be desirable to make the tag visibility, which is the reverse of tag invisibility, evenly for all directions rather than being biased in some directions.

The square and the parallelogram tag arrangements, shown in Fig. 6a) and Fig. 6b), have been most widely used. In the case of square arrangement, tags cannot be sensed at all while a mobile robot moves along either horizontal or vertical directions. As the sensing radius is smaller compared to the tag spacing, the problem of tag invisibility becomes more serious. In the case of parallelogram arrangement, the problem of tag invisibility still exists along two but nonorthogonal directions, which results in a slightly better situation compared with the case of square arrangement. On the other hand, in the case of tilted square tag arrangement, shown in Fig. 6c), the situation gets better along both horizontal and vertical directions. Finally, in the case of equilateral triangular tag arrangement, shown in Fig. 6d), the problem of tag invisibility exists along three equiangular directions, however, the range of tag invisibility becomes smaller compared to the cases of both square and the parallelogram arrangements.

## 4. Pseudorandom tag arrangement

To significantly reduce the tag invisibility in all directions, the random tag arrangement, shown in Fig. 7, seems to be best. Note that each four tags are placed on a square tile under the same restriction imposed on three square tag patterns shown in Fig. 5. Due to highly expected installation difficulty, however, it is hard to select the random tag arrangement in practice.

Taking into account both tag invisibility and installation difficulty, a pseudorandom tag arrangement is proposed using a set of different tilted squares that have different angles of rotation, shown in Fig. 5c). It is expected that the proposed pseudorandom tag arrangement exhibit randomness to some extent without increasing the difficulty in installation.

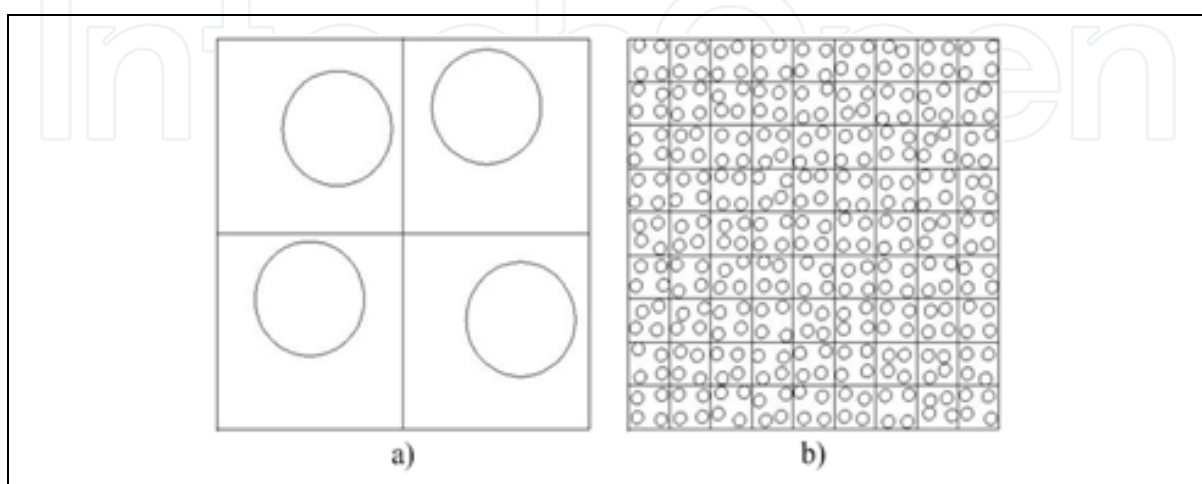

Fig. 7. Random tag arrangement: a) random pattern and b) random arrangement

First, let us define a set of nine different tilted square tag patterns as follows. Since the rotation by  $90^\circ$  makes the resulting tilted pattern back to the original one, we propose to use the set of discrete angles of rotation, given by

$$\Phi_K = (K-1)\frac{\pi}{2} = (K-1)\frac{\pi}{18}, \quad K = 1, \dots, 9 \quad (10)$$

where  $K = 1$  corresponds to the square pattern shown in Fig. 5a). Fig. 8 shows the set of nine different tilted square patterns, given by (10). After making nine copies of each set of nine different tilted square tag patterns, we place them on the floor side by side, according to the number placement in the Sudoku puzzle. In the Sudoku puzzle, the numbers '1' through '9' should be placed in a  $9 \times 9$  array without any duplication along horizontal, vertical, and diagonal directions.

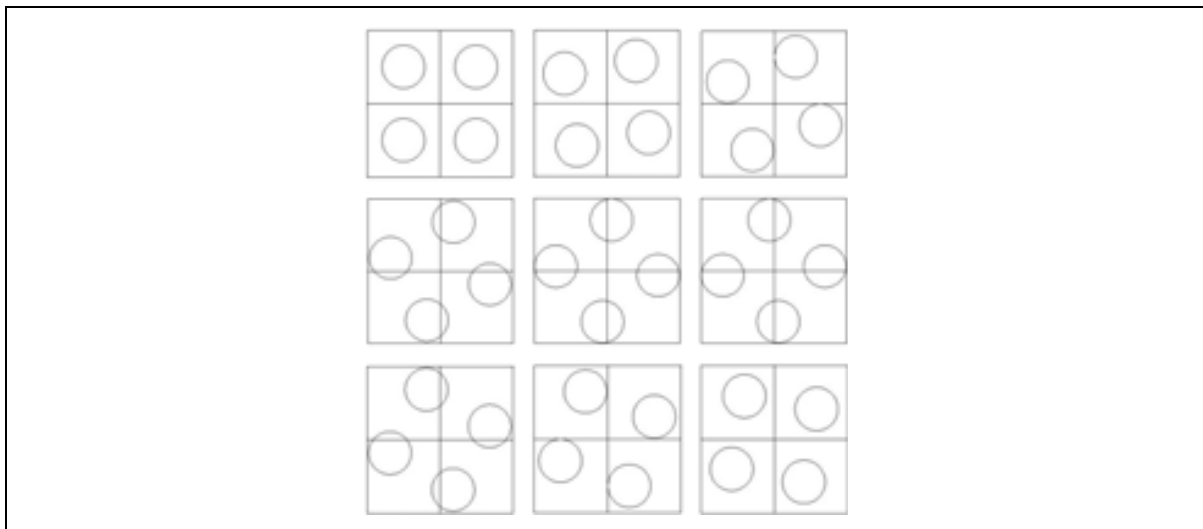

Fig. 8. The set of nine different tilted square patterns

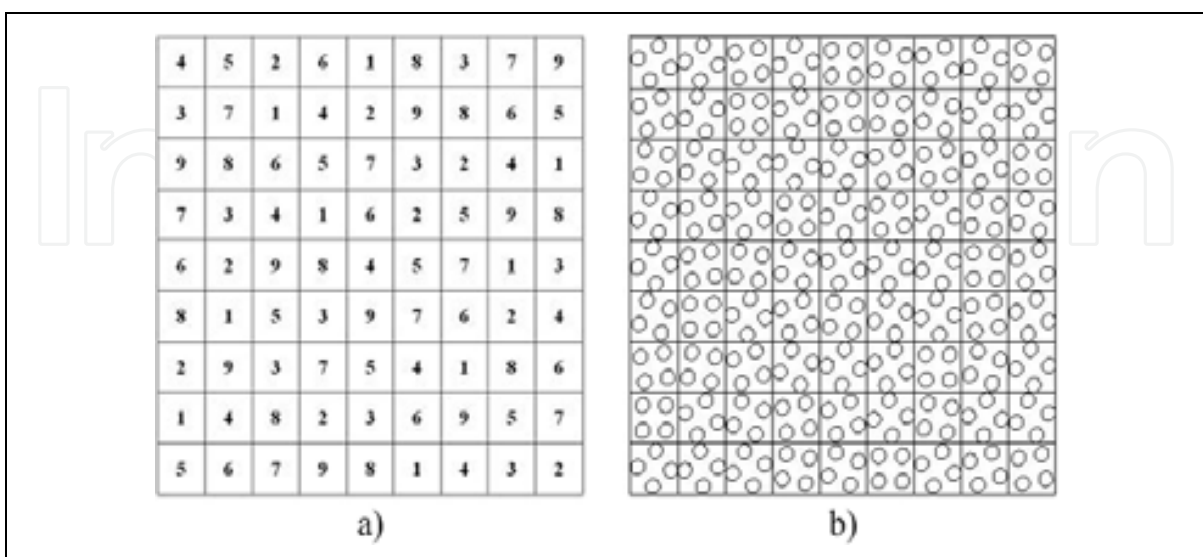

Fig. 9. Pseudorandom tag arrangement: a) one solution to the Sudoku puzzle and b) the corresponding tag arrangement

Fig. 9 shows one solution to the Sudoku puzzle and the corresponding tag arrangement. Compared to the random tag arrangement shown in Fig. 7b), it can be observed that the tag arrangement shown in Fig. 9b) exhibits randomness successively, which is called the pseudorandom tag arrangement.

## 5. Experimental results

In our experiments, a commercial passive RFID system from Inside Contactless Inc. is used, which consists of M300-2G RFID reader, circular loop antenna, and ISO 15693 13.56 MHz coin type tags. Fig. 10 shows our experimental RFID based localization system, in which the reader and the antenna are placed, respectively, on the top and at the bottom of a circular shaped mobile robot. The antenna is installed at the height of 1.5 cm from the floor, and the effective sensing radius is found to be about 10 cm through experiment. For experimental flexibility, each tag is given a unique identification number, which can be readily mapped to the absolute positional information.

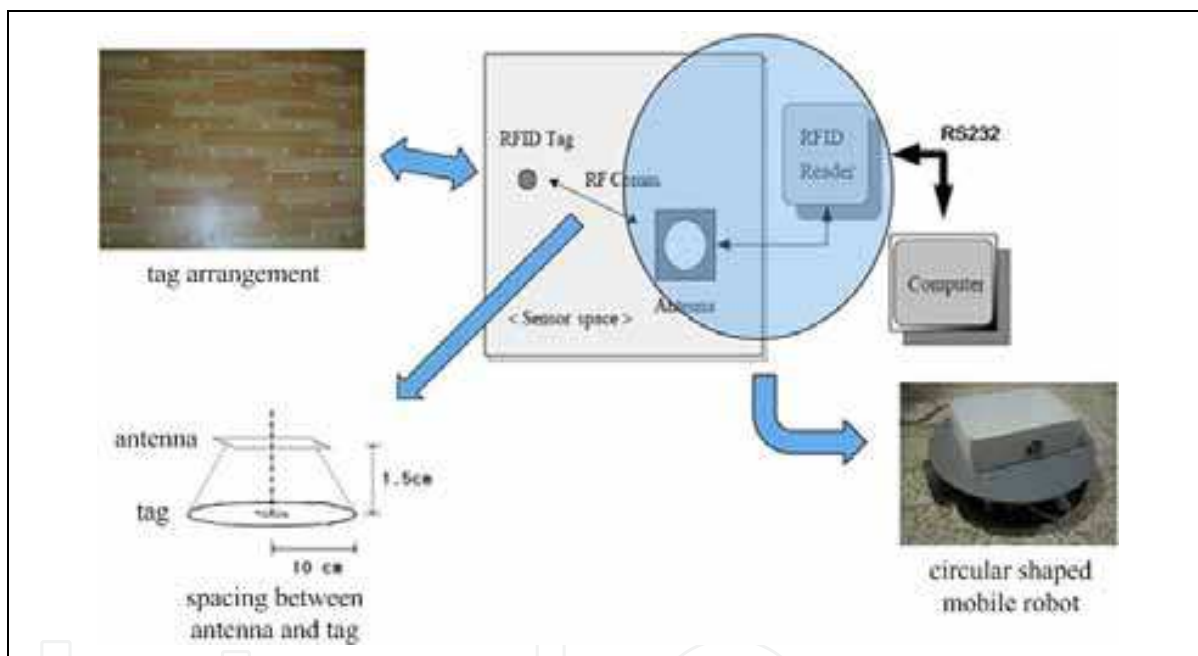

Fig. 10. The experimental RFID based localization system

As a mobile robot navigates over the floor covered with tags, the antenna reads the positional information from the tag within the sensing region, which is then sent to the reader through the coaxial cable. The reader transmits the positional data to the notebook computer at the rate of 115200 bps through RS-232 serial cable. Using a sequence of received data, the notebook computer executes the embedded mobile robot localization algorithm described in this paper.

To demonstrate the validity and performance of our RFID based mobile robot localization, extensive test drives were performed. First, Fig. 11 shows the pseudorandom tag arrangement on the floor that is used in our experiments. For easy installation, each four tags having 10 cm sensing radius are attached on a 70×70 cm square tile in a tiled square pattern. With different angles of rotation, given by (10), nine different square tiles are constructed and their copies are made. Then, a total of sixteen square tiles are placed side by side in a 4×4 array, resulting in a 280×280 cm floor with the pseudorandom tag

arrangement. At each test drive, a mobile robot is to travel along a right angled triangular path shown in Fig. 11, where two perpendicular sides are set to be parallel to the  $x$  axis and the  $y$  axis. A mobile robot is commanded at a constant speed of 10 cm/ sec along three linear segments, starting from (30,30), passing through (250,250) and (250,30), and returning to (30,30).

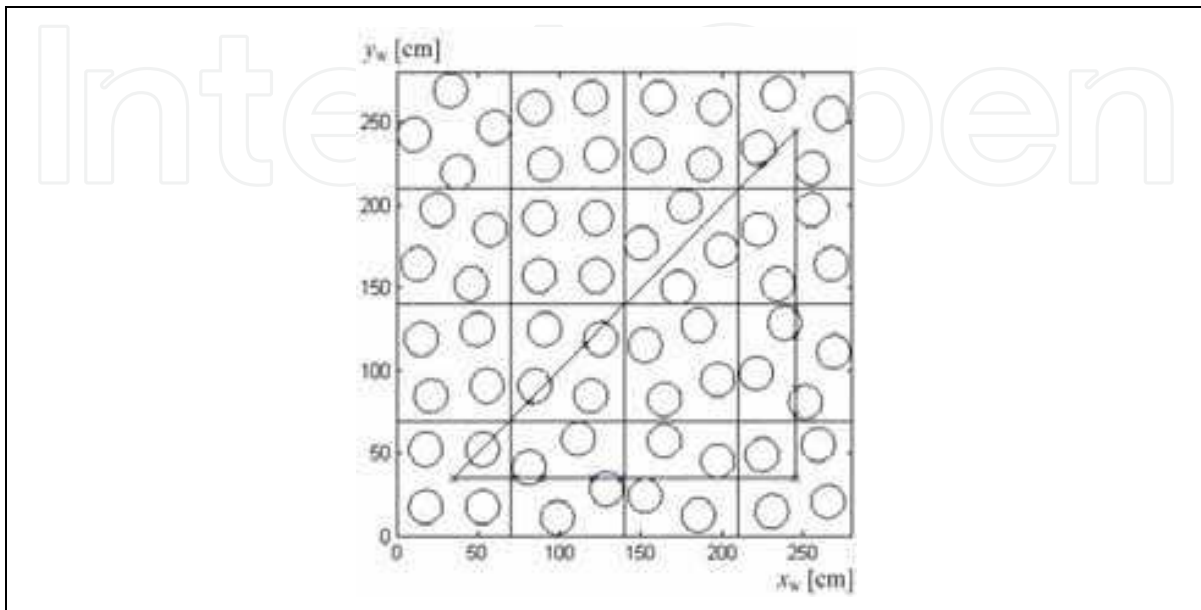

Fig. 11. The experimental pseudorandom tag arrangement and the closed path trajectory

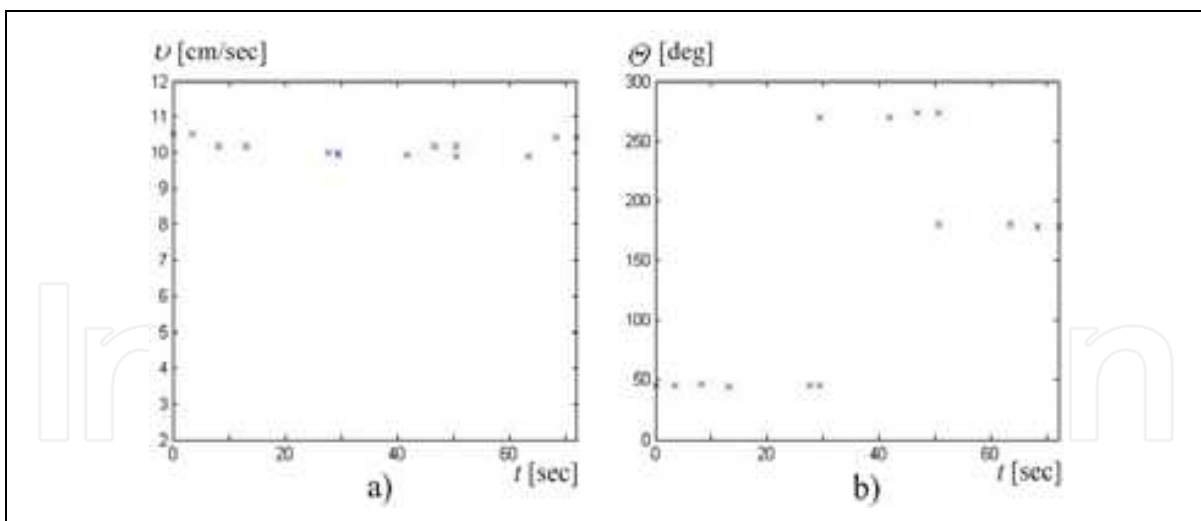

Fig. 12. The mobile robot velocity estimates: a) the forwarding speed and b) the steering angle

Fig. 12 shows the componentwise plots of the estimated mobile robot velocities along the right angled triangular path, obtained based on (4) and (6). Small difference between the estimated and the actual mobile robot velocities can be observed, which seem to be largely attributed to measurement noises involved. Next, Fig. 13 shows the componentwise plots of the estimated mobile robot positions along the right angled triangular path, which are computed from the mobile robot velocity estimates. The deviations from the actual mobile

robot positions are also plotted in Fig. 13, which are again relatively small. Fig. 14 shows the estimated and the actual mobile robot trajectories on the floor, marked by 'x', and 'o', respectively. It can be observed that the estimated mobile robot trajectory is fairly close to the actual one.

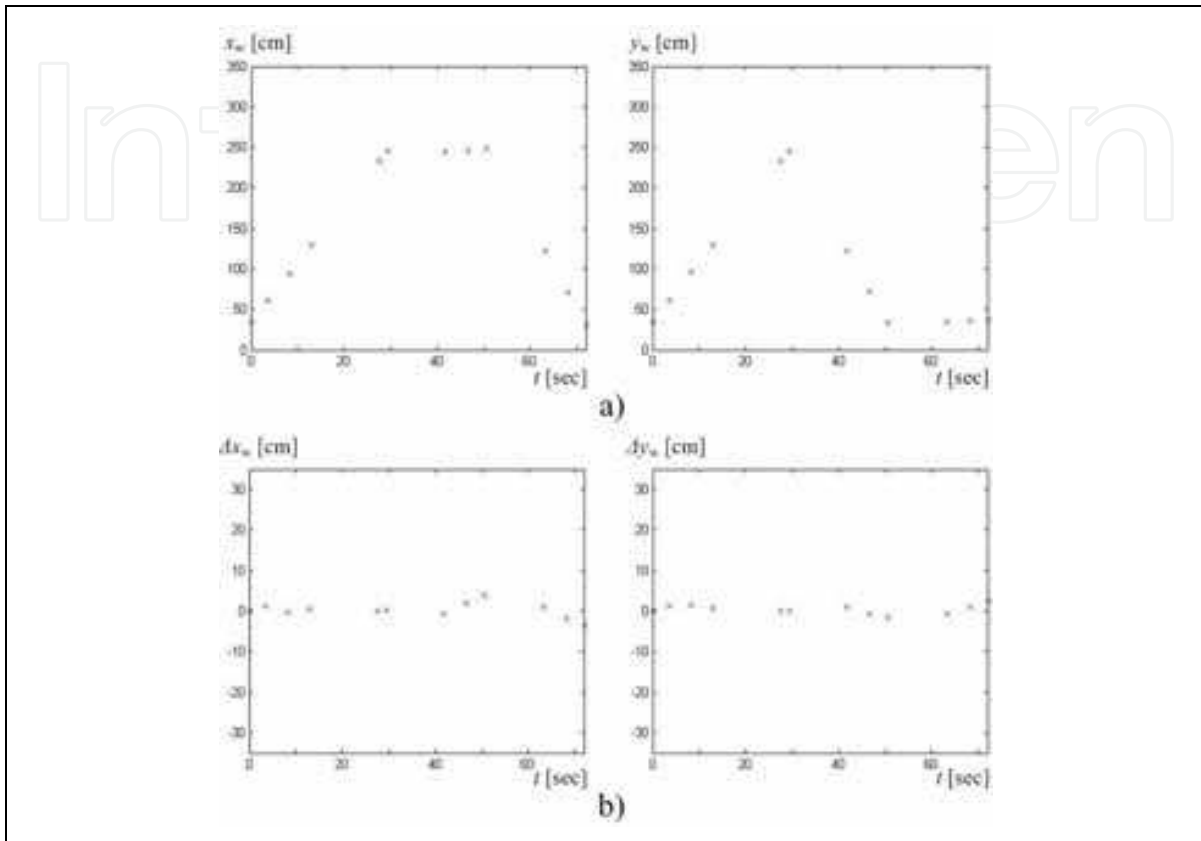

Fig. 13. The mobile robot localization: a) the componentwise positional estimates and b) the deviations from the actual values

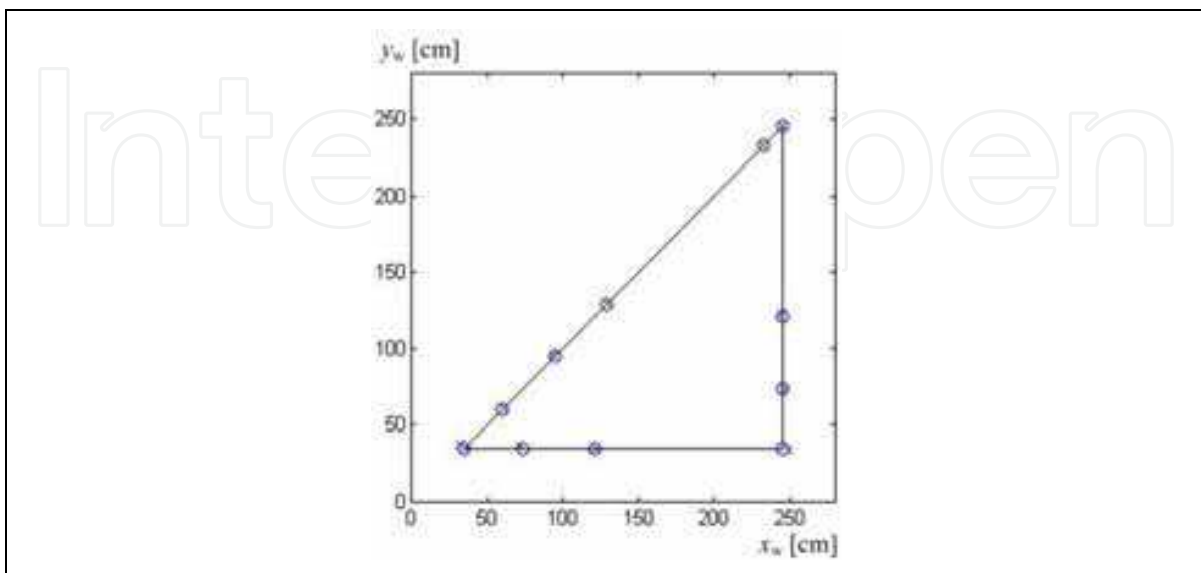

Fig. 14. The estimated trajectory, marked by 'x', and the actual trajectory, marked by 'o'

Finally, the same test drive above was repeated 50 times to see how closely a mobile robot can return to the starting position after the closed path navigation. Fig. 15 shows the plot of the positional homing errors, which are the differences of the returning positions from the starting position. It can be observed that the positional homing errors are kept less than 5 cm. Considering that the tag distribution density is relatively low, this result seems quite satisfactory.

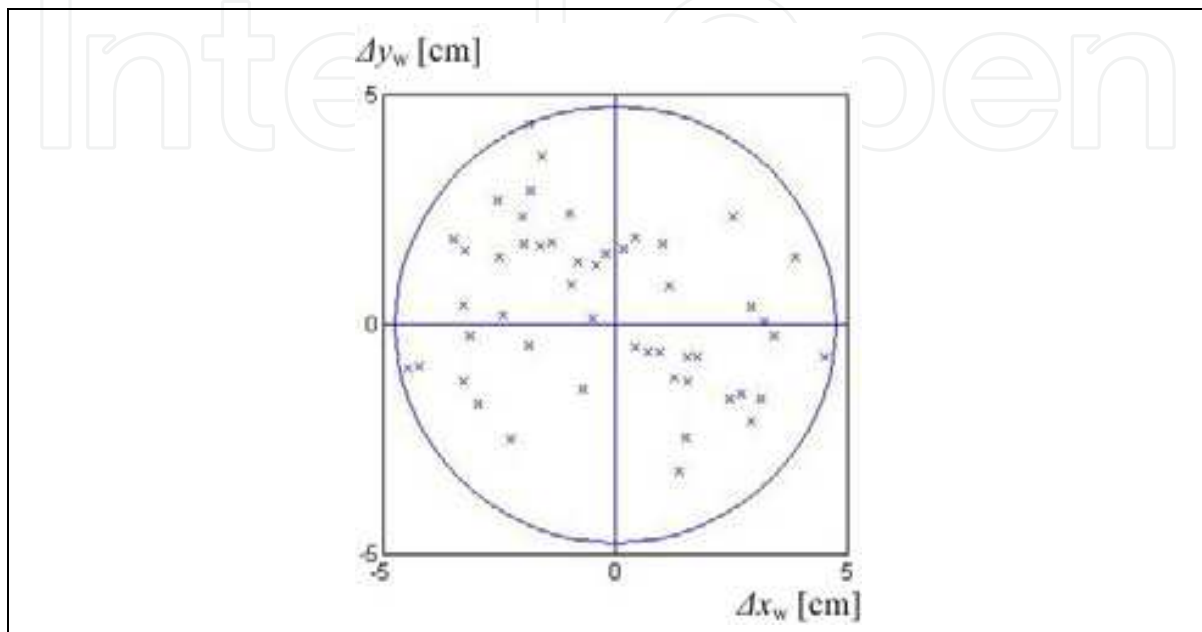

Fig. 15. The positional homing errors after the closed path navigations

## 6. Conclusion

This paper presented a pseudorandom RFID tag arrangement for improved performance of mobile robot localization. First, using temporal as well as spatial information on tag traversing, we developed a simple but effective mobile robot localization method. Second, we examined four repetitive tag arrangements, including square, parallelogram, tilted square, and equilateral triangle, in terms of tag installation and tag invisibility. Third, taking into account both tag invisibility and tag installation, we proposed the pseudorandom tag arrangement, inspired from the Sudoku puzzle. Currently, a study is under way for the quantitative evaluation and optimal design of tag arrangements. We hope that the results of this paper can provide an effective solution to the indoor localization of personal/ service robots.

## 7. Acknowledgement

This work was supported by the Hankuk University of Foreign Studies Research Fund of 2010, Republic of KOREA.

## 8. References

Borenstein, J, Everett, H. R., & Feng, L. (1996). *Where am I? Sensors and Methods for Mobile Robot Positioning*, The University of Michigan



- Finkenzeller, K. (2000). *RFID handbook: Fundamentals and Applications*, Wiley.
- Kubitz, O., Berger, M. O., Perlick, M. & Dumoulin, R. (1997). Application of radio frequency identification devices to support navigation of autonomous mobile robots, *Proc. IEEE Vehicular Technology Conf.*, pp. 126-130
- Kantor, G. & Singh, S. (2002). Preliminary results in read-only localization and mapping, *Proc. IEEE Int. Conf. Robotics and Automation*, pp. 1818-1823
- Hahnel, D., Burgard, W., Fox, D., Fishkin, K., & Philipose, M. (2004). Mapping and localization with RFID technology, *Proc. IEEE Int. Conf. Robotics and Automation*, pp. 1015-1020
- Kulyukin, V, Gharpure, C., Nicholson, J & Pavithran, S. (2004). RFID in robot-assisted indoor navigation for the visually impaired, *Proc. IEEE/ RSJ Int. Conf. Intelligent Robots and Systems*, pp. 1979-1984
- Penttila, K, Sydanheimo, L. & Kivikoski, M. (2004). Performance development of a high-speed automatic object identification using passive RFID technology, *Proc. IEEE Int. Conf. Robotics and Automation*, pp. 4864-4868
- Yamano, K, Tanaka, K, Hirayama, M., Kondo, E., Kimura, Y., & Matsumoto, M. (2004). Self-localization of mobile robots with RFID system by using support vector machine, *Proc. IEEE/ RSJ Int. Conf. Intelligent Robots and Systems*, pp. 3756-3761
- Kim, B.K, Tomokuni, N., Ohara, K, Tanikawa, T., Ohba, K., & Hirai, S. (2006). Ubiquitous localization and mapping for robots with ambient intelligence, *Proc. IEEE/ RSJ Int. Conf. Intelligent Robots and Systems*, pp. 4809-4814
- Vorst, P., Schneegans, S., Yang, B., & Zell, A. (2008). Self-localization with RFID snapshots in densely tagged environments, *Proc. IEEE/ RSJ Int. Conf. Intelligent Robots and Systems*, pp. 1353-1358
- Bohn, J and Mattern, F. (2004). Super-distributed RFID tag infrastructure, *Lecture Notes in Computer Science*, vol. 3295, pp. 1-12
- Choi, J, Oh, D., & Kim, S. (2006). CPR Localization Using the RFID Tag-Floor, *Lecture Notes in Computer Science*, vol. 4099, pp. 870-874
- Han, S., Lim, H., & Lee, J (2007). An Efficient Localization Scheme for a Differential-Driving Mobile Robot Based on RFID System, *IEEE Trans. Industrial Electronics*, vol. 54, no. 6, pp. 3362-3369
- Kodaka, K, Niwa, H., Sakamoto, Y., Otake, M., Kanemori, Y., & Sugano, S. (2008). Pose estimation of a mobile robot on a lattice of RFID tags, *Proc. IEEE/ RSJ Int. Conf. Intelligent Robots and Systems*, pp. 1385-1390

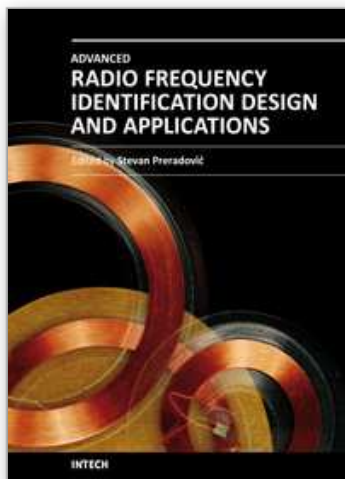

## **Advanced Radio Frequency Identification Design and Applications**

Edited by Dr Stevan Preradovic

ISBN 978-953-307-168-8

Hard cover, 282 pages

**Publisher** InTech

**Published online** 22, March, 2011

**Published in print edition** March, 2011

Radio Frequency Identification (RFID) is a modern wireless data transmission and reception technique for applications including automatic identification, asset tracking and security surveillance. This book focuses on the advances in RFID tag antenna and ASIC design, novel chipless RFID tag design, security protocol enhancements along with some novel applications of RFID.

### **How to reference**

In order to correctly reference this scholarly work, feel free to copy and paste the following:

Sungbok Kim and Hyunbin Kim (2011). Pseudorandom Tag Arrangement for Accurate RFID based Mobile Robot Localization, Advanced Radio Frequency Identification Design and Applications, Dr Stevan Preradovic (Ed.), ISBN: 978-953-307-168-8, InTech, Available from: <http://www.intechopen.com/books/advanced-radio-frequency-identification-design-and-applications/pseudorandom-tag-arrangement-for-accurate-rfid-based-mobile-robot-localization>

**INTECH**  
open science | open minds

### **InTech Europe**

University Campus STeP Ri  
Slavka Krautzeka 83/A  
51000 Rijeka, Croatia  
Phone: +385 (51) 770 447  
Fax: +385 (51) 686 166  
[www.intechopen.com](http://www.intechopen.com)

### **InTech China**

Unit 405, Office Block, Hotel Equatorial Shanghai  
No.65, Yan An Road (West), Shanghai, 200040, China  
中国上海市延安西路65号上海国际贵都大饭店办公楼405单元  
Phone: +86-21-62489820  
Fax: +86-21-62489821

© 2011 The Author(s). Licensee IntechOpen. This chapter is distributed under the terms of the [Creative Commons Attribution-NonCommercial-ShareAlike-3.0 License](#), which permits use, distribution and reproduction for non-commercial purposes, provided the original is properly cited and derivative works building on this content are distributed under the same license.

IntechOpen

IntechOpen