

We are IntechOpen, the world's leading publisher of Open Access books Built by scientists, for scientists

4,800

Open access books available

122,000

International authors and editors

135M

Downloads

Our authors are among the

154

Countries delivered to

TOP 1%

most cited scientists

12.2%

Contributors from top 500 universities



WEB OF SCIENCE™

Selection of our books indexed in the Book Citation Index
in Web of Science™ Core Collection (BKCI)

Interested in publishing with us?
Contact book.department@intechopen.com

Numbers displayed above are based on latest data collected.

For more information visit www.intechopen.com



Cost Effective Computational Approach for Generation of Polymeric Composite Material Allowables for Reduced Testing

G. Abumeri¹, F. Abdi¹, K.S. Raju², J. Housner¹,
R. Bohner³ and A. McCloskey³

¹Alpha STAR Corp., Long Beach, CA

²National Institute for Aviation Research, Wichita State University, KS

³Northrop Grumman Corporation, El Segundo CA
USA

1. Introduction

The objective of this work is to provide the aerospace community with a robust computational capability to determine composite material strength allowables. The technical approach presented in this document serves two purposes: (1) reduce laminate level testing for determination of allowables; and (2) estimate allowables with some level of reliability when such data are difficult to obtain. A- and B-basis strength values are essential for reducing risk in aircraft structural components made from fiber reinforced polymer composite materials. Risk reduction is achieved by lowering the probability of failure of critical aircraft structures through the use of A- and B-basis design values. Generating strength allowables solely by means of testing is costly and time consuming as large number of composite coupons must be tested under various environments: cold, ambient and elevated temperatures (with and without moisture). The aerospace community is challenged by the following: (1) tests must be conducted on many types of coupons to determine allowables for in-plane and out-of-plane properties (un-notched and notched); and (2) new composite materials are introduced to the market at a rapid rate amplifying the need for timely cost effective approach. The tests must be carried out in accordance to standards set by ASTM (American Society for Testing and Materials).

Current practices for determining allowables follow procedures recommended by FAA and working draft of the composite materials handbook CMH-17 Rev G (formerly military handbook Mil-HDBK-17-1F) [1&2]. **Table 1** lists the robust and reduced test sampling requirements set forth by CMH-17. Determination of A-basis values requires more test samples than those needed to determine B-basis values as A-basis strength are applied to single members within an assembly whose failure would result in loss of structural integrity. For A-basis, at least 99% of the population of material strength values is expected to equal or exceed this tolerance bound with 95% confidence. B-basis values are applied to redundant structures where failure would result in safe load redistribution. For B-basis, 90% of the population of material strength values is expected to equal or exceed that strength value with 95% confidence. **Figure 1** illustrates the statistical definition of 0.01 and 0.10 probabilistic

strength for A-basis and B-basis, respectively. The physical definition of A- and B-basis is presented in Figure 2. A-basis strength value [2] is traditionally calculated using equation $(\bar{x} - (K_A) \cdot S)$; similarly B-basis strength value is computed using equation $(\bar{x} - (K_B) \cdot S)$; where \bar{x} is the mean strength of the test samples, S is sample standard deviation, and K_A and K_B are tolerance factors. The higher the tolerance factor, the lower the allowable; the higher the number of test replicates the more stable the allowable. CMH-17 provides tables of tolerance factors for various distributions as function of the sample size. The same procedures and standards require checking for outliers, distribution types if non-normality is observed, and batch variability. Details on numerical and test procedures for standard practice for determination of allowables can be found in [1 & 2].

Category	# of Batches	# of Samples	Category	# of Batches	# of Samples
A-basis - Robust Sampling	10	75	B-basis - Robust Sampling	10	55
A-basis - Reduced Sampling	5	55	B-basis - Reduced Sampling	3	18

Table 1. FAA Guidelines for Robust and Reduced Sampling

The proposed approach for determination of strength allowables builds on existing accepted standards and practices [1&2]. It uses statistics from lamina level testing to reverse engineer uncertainties in fiber and matrix material properties and manufacturing variables. These uncertainties are subsequently used in generating virtual test samples for laminated notched and un-notched specimens. The virtual samples are then used in lieu of actual test samples with resulting savings in cost and time. The methodology combines probabilistic methods with advanced multi-scale multi-physics progressive failure analysis (MS-PFA) [4] to reduce the number of tests needed for determination of A- and B-basis strength values. Details of the technical approach are provided next and the viability of the approach is demonstrated through application to four composite materials.

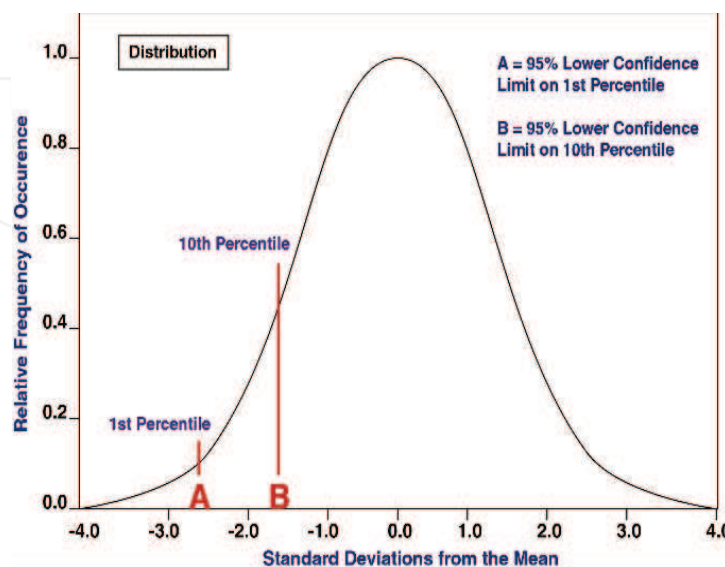

Fig. 1. Statistical Definition of A-and B-basis Strength [3]

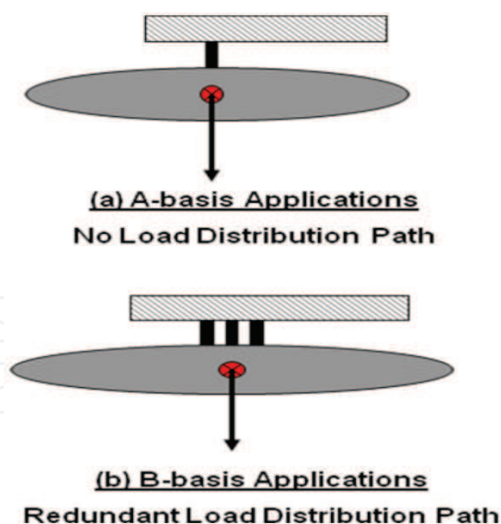

Fig. 2. Physical Definition of A-and B-Basis Strength

2. Nomenclature

E_{11}	Lamina extensional modulus in fiber direction
E_{22}	Lamina extensional modulus perpendicular to fiber direction
E_{f11}	Fiber extensional modulus in fiber direction
E_{f22}	Fiber extensional modulus perpendicular to fiber direction
E_m	Matrix extensional modulus
Eps11C	Lamina compressive strain limit parallel to fiber
Eps11T	Lamina tensile strain limit parallel to fiber
Eps12S	Lamina in-plane strain limit
Eps22C	Lamina compressive strain limit perpendicular to fiber
Eps22T	Lamina tensile strain limit perpendicular to fiber
FVR	Fiber volume ratio
VVR	Void volume ratio
MVR	Matrix volume ratio
G_{12}	Lamina in-plane shear modulus
G_{f12}	Fiber shear modulus - In-plane
G_{f23}	Fiber shear modulus - Out-of-plane
GUI	Graphical user interface
IPS	In-plane shear
LC	Longitudinal compression
LT	Longitudinal tension
S11C	Lamina compressive strength in fiber direction
S11T	Lamina tensile strength in fiber direction
S12S	Lamina in-plane shear strength
S22C	Lamina compressive strength perpendicular to fiber direction
S22T	Lamina tensile strength perpendicular to fiber direction
Sf11 C	Fiber compressive strength
Sf11T	Fiber tensile strength
SmC	Matrix compressive strength
SmS	Matrix shear strength

SmT	Matrix tensile strength
TT	Transverse tension
TC	Transverse compression
CDF	Cumulative distribution function
PDF	Probability density function
COV	Coefficient of variation

3. Description of technical approach

Methodology and computational procedure is described as an integrated MS-PFA and probabilistic analysis capability. It is comprised of the following:

- determination of scatter and sensitivity of in-situ material properties and fabrication parameters (e.g., fiber tensile strength, and fiber volume ratio);
- reproducing the test measured scatter/distribution in lamina using MS-PFA, and probabilistic analysis;
- generate random samples using lamina level uncertainties;
- update scatter from simulation to match lamina CDF and PDF curves using Bayesian statistics followed by determination of allowables with the desired confidence levels;

Scatter in strength data obtained from unidirectional lamina testing is used in predicting allowables for notched and un-notched laminates. The variability is generally caused by: (1) scatter in micro-scale mechanical properties of the fiber, matrix, and interface; (2) variability in composite manufacturing parameters; and (3) manufacturing defects such as void, waviness, and gaps. Lamina level testing is carried out to determine ply in-plane and out-of-plane mechanical properties. **Table 2** lists the measured ply properties obtained from in-plane testing of composite specimens made from unidirectional laminates. The same table also lists the physical parameters influencing the measured ply response. For example, variation in ply longitudinal strength collected from test is a function of scatter of fiber strength and fiber content. MS-PFA [4] is used in conjunction with probabilistic methods [5] to reproduce scatter in strength obtained from lamina level testing. **Figure 3** shows the lamina level testing performed per ASTM standards to generate in-plane ply properties. **Figure 4** shows the process for reproducing the scatter from lamina level testing. Micro-scale random variables consisting of fiber and matrix mechanical properties combined with fabrication parameters are perturbed to reproduce the scatter from lamina level testing. This process results in a unique set of coefficient of variations for various random variables that can be used in random sampling of test specimens for higher order ASTM tests (laminate level).

The use of lamina level uncertainties to predict allowables for laminate level building block tests is the added value of the work presented in this paper. The work reported in [6] confirms that lamina uncertainties are adequate for use in generation of scatter in laminate level response. The uncertainties causing scatter in strength of a composite laminate are: (1) variability in fiber and matrix properties and composite fabrication parameters; (2) manufacturing defects (“as designed” versus “as built” and “as is”); and (3) human error encountered during testing. A flow chart of the technical approach for determination of A- and B-basis allowables is presented in **Figure 5**. The basis for the computation is the reproduction of scatter in ply strength caused by variability of constituent material properties and manufacturing defects. The approach was validated by comparing its A- and B-basis predictions with values obtained from standard methods [1&2] using test data from robust or reduced sampling.

Measured Ply Property	Physical Variables Influencing Measured Property
Longitudinal tension strength (S11T)	Fiber tensile strength (Sf11T) and fiber volume ratio (FVR)
Longitudinal tension modulus (E11T)	Fiber longitudinal tensile stiffness (Ef11) and fiber volume ratio (FVR)
Longitudinal compression strength (S11C)	Fiber compressive strength (Sf11C) and fiber volume ratio (FVR), fiber micro-buckling
Longitudinal compression modulus (E11C)	Fiber longitudinal compressive stiffness (Ef11) and fiber volume ratio (FVR)
Transverse tension strength (S22T)	Matrix tensile strength (SmT) and matrix volume ratio (MVR)
Transverse tension modulus (E22T)	Matrix modulus (Em), fiber transverse modulus and matrix volume ratio (MVR)
Transverse compression strength (S22C)	Matrix compressive strength (SmC) and matrix volume ratio (MVR)
Transverse compression modulus (E22C)	Matrix modulus (Em) and matrix volume ratio (MVR)
In-Plane shear strength at 0.2% Offset (IPS)	Matrix shear strength (SmS) and matrix volume ratio (MVR)
In-Plane shear strength at 5% Strain (IPS)	Matrix shear strength (SmS) and matrix volume ratio (MVR) and nonlinear properties of the matrix
In plane shear modulus (G12)	Matrix modulus (Em), matrix Poisson's ratio, Fiber Shear Modulus (Gf12) and matrix volume ratio (MVR)

Table 2. Stiffness and Strength Properties Obtained by Physical Testing of Composite Specimens (in-plane loading)

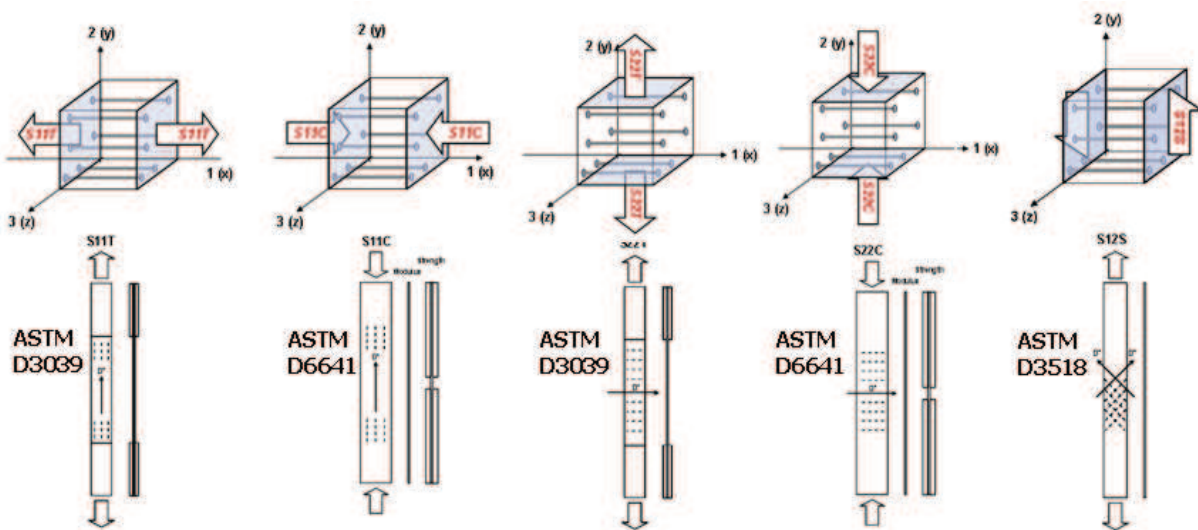

Fig. 3. Five Basic ASTM Tests are Needed at the Lamina Level to Characterize Fiber and Matrix Constituent Material Properties

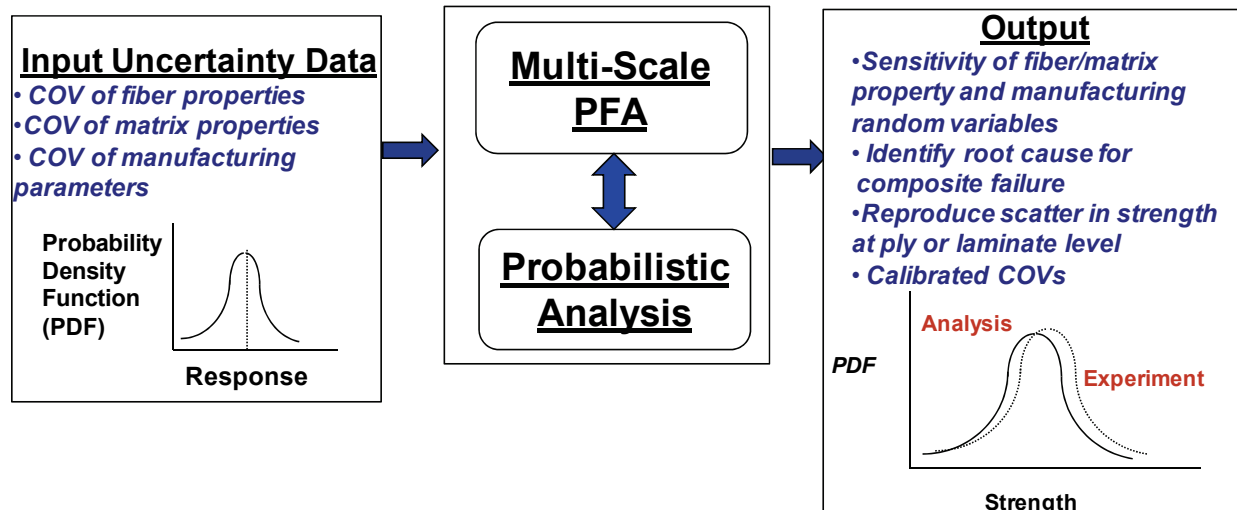

Fig. 4. Process for Reproducing Scatter from Ply or Laminate Level Testing

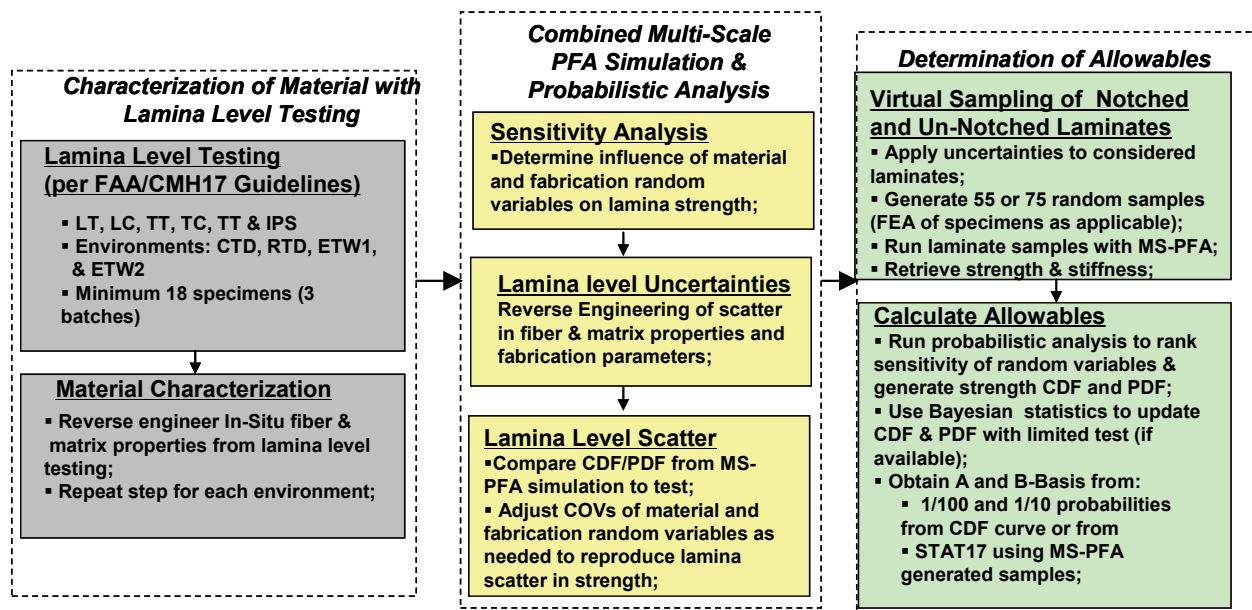

Fig. 5. Technical Approach for Determination of A- and B-Basis with Reduced Testing

4. Validation of technical approach

The computational capability described herein is validated for polymer composite materials typically used in aerospace applications. Data for MTM45-1 145 AS4, IM7/MTM45 graphite/epoxy and T300/PPS material are used to demonstrate the effectiveness of the methodology. Additionally, the capability of obtaining A-basis starting from B-basis is demonstrated.

Strength Allowables for MTM45-1 145 AS4 (Lamina Level)

Ply properties from lamina level testing at room temperature dry condition, obtained from [7], are used to characterize the MTM45-1 145 AS4 tape composite material. This is achieved by deriving its in-situ fiber and matrix properties. Table 3 lists the AS4 fiber in-situ

mechanical properties while **Table 4** lists similar properties for the MTM45 matrix. The derived constituent properties combined with ply manufacturing parameters of 61% fiber volume fraction and 2% void volume fraction reproduced accurately the average ply properties reported from test in [7]. A comparison of calculated ply properties by MS-PFA simulation and test is presented in **Table 5**. With accurate determination of average ply properties starting from in-situ fiber matrix properties, random variables statistics for micro-scale mechanical properties are obtained directly from lamina level testing published in [7]. **Table 6** lists the derived random variables statistics for use in determination of strength allowables for MTM45-1 145 AS4. The COVs of strength and stiffness properties were obtained from lamina level tests published in reference [7] while the COVs of other random variables were iterated on to ensure proper simulation of lamina level scatter. The considered random variables included fiber and matrix stiffness and strength and fiber and

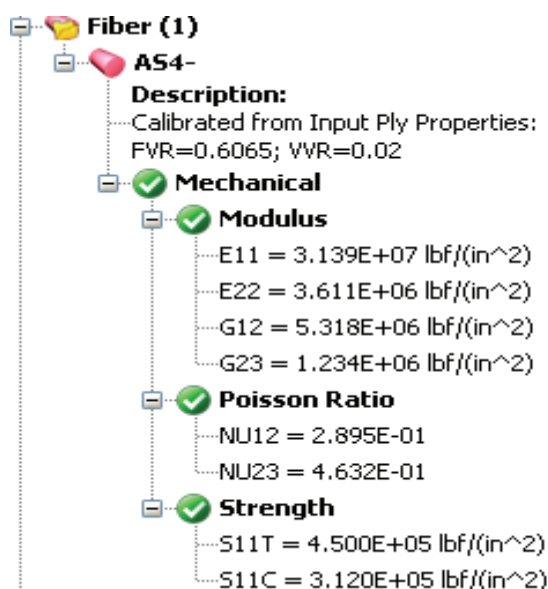

Table 3. AS4 Fiber In-Situ Properties

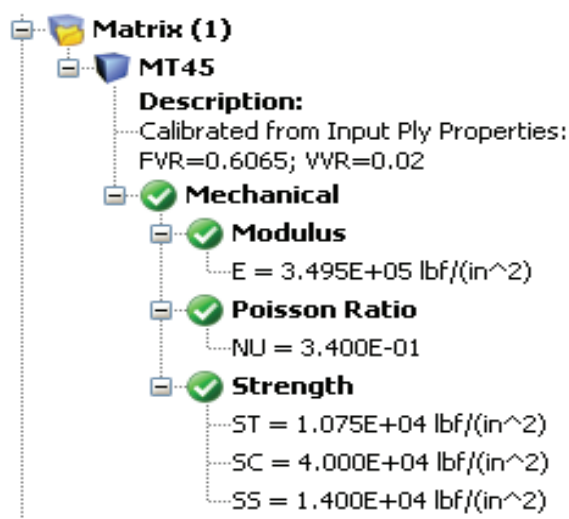

Table 4. MTM45 Matrix In-Situ Properties

AS4/12K (Tape): FVR=60.65%; VVR=2%			
Property	RTD		
	Test [msi]	Simulation [msi]	Error [%]
E11	17.925	18.79	4.83
E22	1.2	1.15	-4.17
G12	0.53	0.53	0.00
	[ksi]	[ksi]	[%]
S11T	274.78	271.6	-1.16
S11C	203.53	200.9	-1.29
S22T	6.92	6.84	-1.16
S22C	26.81	25.18	-6.08
S12S	9.36	8.68	-7.26

Table 5. Comparison of Average Ply Properties Obtained from Test to those from Simulation for MTM45-1 145 AS4

Fiber-Matrix Properties Random Variables	Mean Value	COV	Standard Deviation	Distribution Type
Fiber Ef11 - Longitudinal modulus (msi)	31.39	3.0%	0.9417	Normal
Fiber Sf11T- Longitudinal tension strength (ksi)	450	5.5%	24.75	Normal
Fiber S11C - Longitudinal compression strength (ksi)	312	5.0%	15.6	Normal
Matrix Em - Normal modulus (msi)	0.3495	3.1%	0.018345	Normal
Matrix SmT - Matrix tension strength (ksi)	10.75	17.5%	1.881	Normal
Matrix SmC - Matrix compression strength (ksi)	40	5.0%	2	Normal
Matrix SmS - Matrix shear strength (ksi)	14	4.0%	0.56	Normal
Manufacturing Parameters Random Variables	Mean Value	COV	Standard Deviation	Distribution Type
Fiber content (%)	60.65	4%	2.426	Normal
Void content (%)	2	2.5%	0.05	Normal

Table 6. Random Variables Statistics for Use in Determining Allowables for MTM45-1 145 AS4 Composite

void contents. The COVs for the mechanical properties were obtained from lamina level testing published in reference [7] using the correlation between measured ply property and micro-scale properties of Table 2. The COVs for the manufacturing variables were obtained by iterating on the scatter produced by combined MS-PFA and probabilistic analysis to match the one from lamina level testing of the five in-plane ASTM tests of Figure 3.

Figure 6 shows the lamina level cumulative distribution functions (CDFs) for the 5 in-plane ASTM tests LT, LC, TT, TC, and IPS generated from virtual test data using MS-PFA simulation and from actual test. The data from test and simulation are fitted to a normal distribution in the plots (a) through (e) for the various ASTM tests. The amount of data reported in reference [7] for each ASTM type varied. For example, for the LT test, 19 samples were reported while for LC a total of 24 samples were reported. The CDF from simulation was generated for each test using the random variables statistics listed in **Table 6**. A total of 55 samples were randomly generated with MS-PFA considering simultaneous uncertainties in material and manufacturing random variables. That means MS-PFA was run 55 times for each ASTM test to predict failure stress for each sample. All variables listed in **Table 6** took on random values for each analysis sample by MS-PFA. As illustrated in **Figures 6-a** through **6-c**, the distribution (scatter) and mean strength generated by the simulation matched perfectly the ones from test for LC, LT, and TT tests.

The data generated for TC and IPS are shown in **Figures 6-d** and **6-e**. The CDFs from simulation are updated for TC and IPS per the procedure outlined in **Figure 5** for fine tuning the COV variables. Initial predictions for mean strength from simulation were 5.5% and 6.3% lower than average from test for TC and IPS. The updates, although not necessary, are done to ensure that the mean strength from simulation matches exactly the mean from test. This process allows the analyst to correlate data from test with simulation and update the simulation results with test data regardless how limited the data is. The difference between mean predicted and test strengths for TC and IPS specimens could be have been reduced to a negligible value by adjusting the calibrated in-situ properties. However, the authors intended to illustrate that the difference in mean strength between simulation and test depicts a realistic situation.

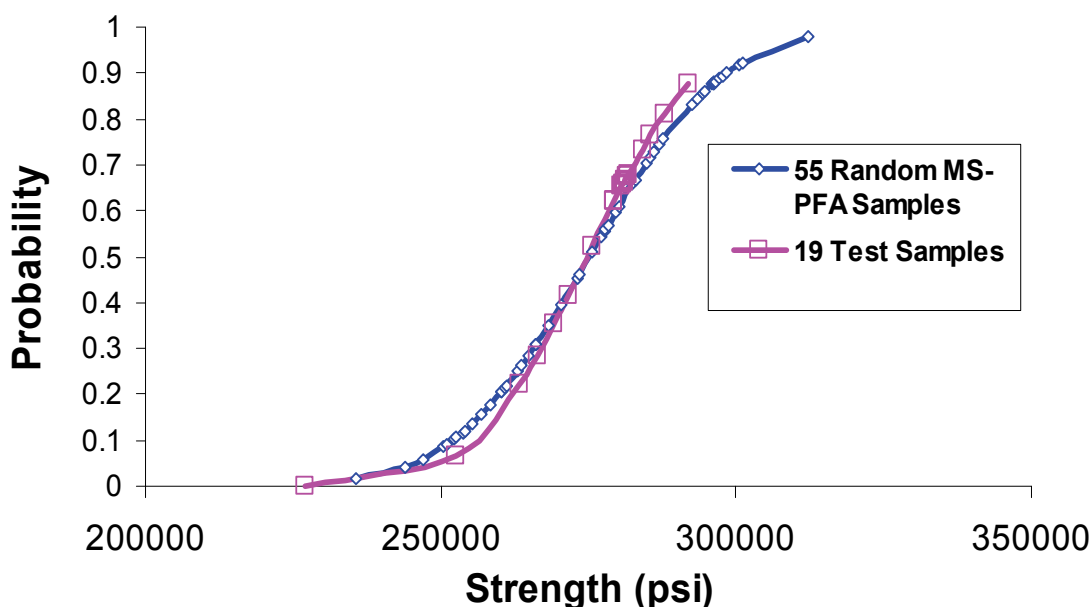

(a) MS-PFA Samples Compared to Test for MTM45-1 145 AS4 Longitudinal Tension (LT)

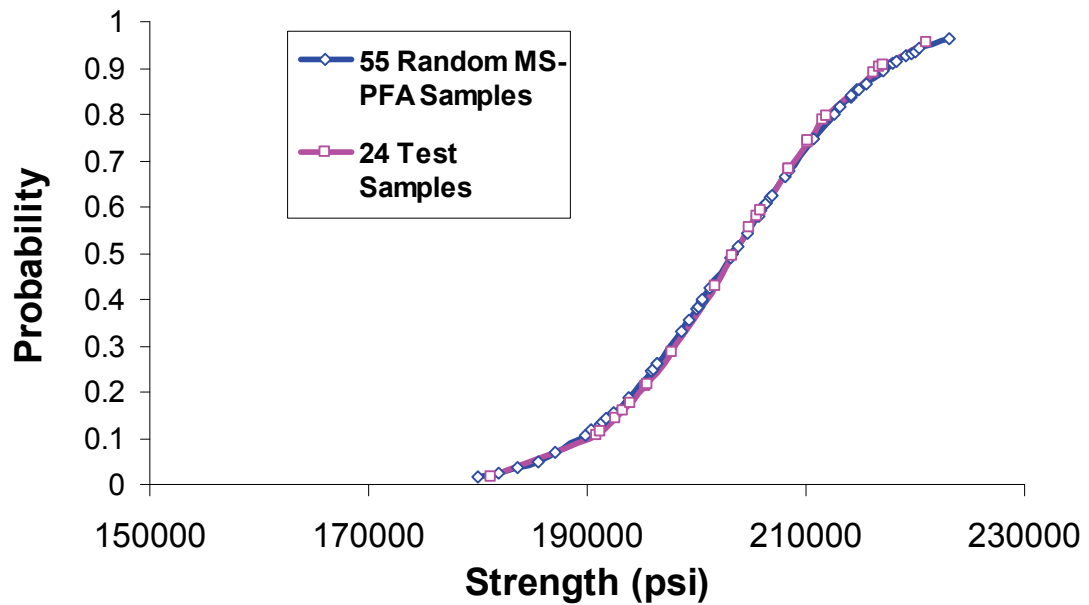

(b) MS-PFA Samples Compared to Test for MTM45-1 145 AS4 Longitudinal Compression (LC)

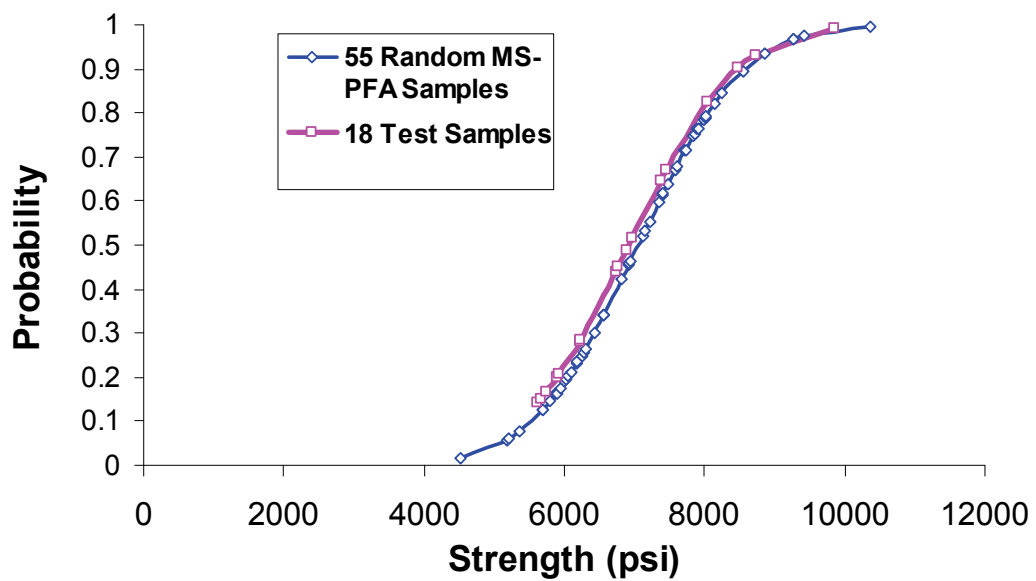

(c) MS-PFA Samples Compared to Test for MTM45-1 145 AS4 Transverse Tension (TT)

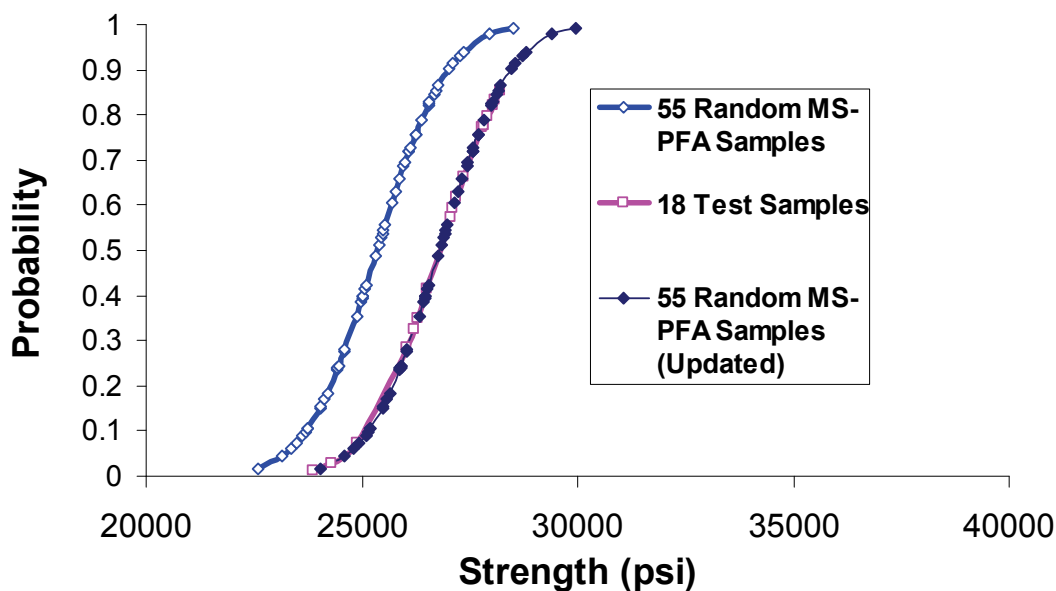

(d) MS-PFA Samples Compared to Test for MTM45-1 145 AS4 Transverse Compression (TC)

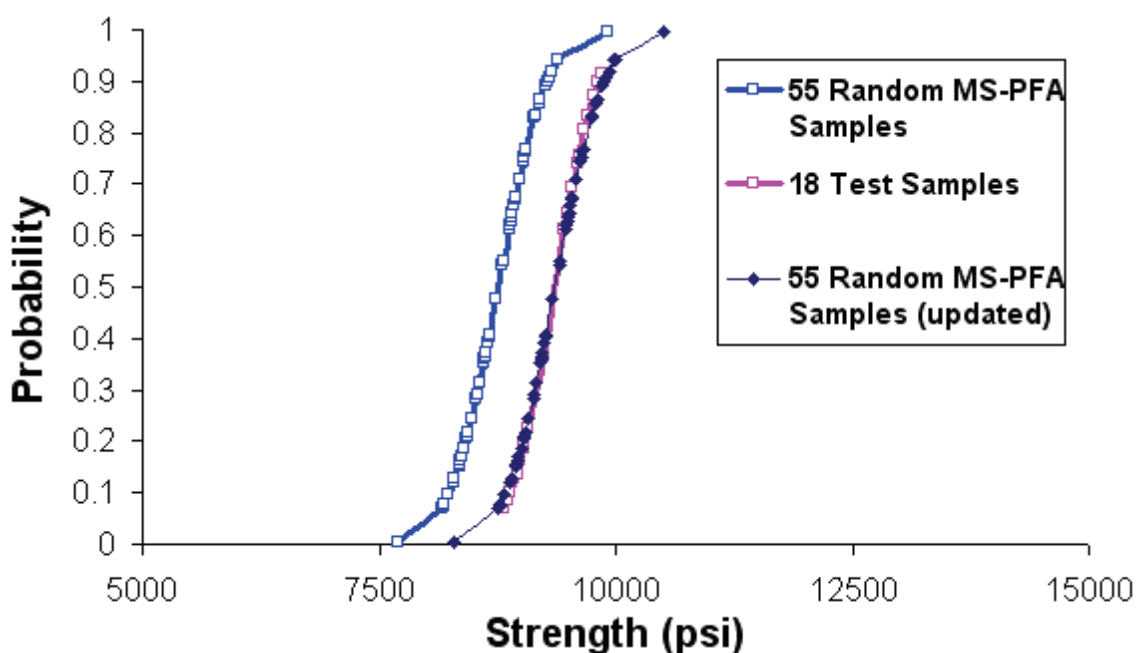

(e) MS-PFA Samples Compared to Test for MTM45-1 145 AS4 In-Plane Shear (IPS)

Fig. 6. Scatter in Failure stress for LT, LC, TT, TC, and IPS Generated by MS-PFA Simulation for MTM45-1 145 AS4 Compared to Lamina Level Test Data [7]

Based on accurate reproduction of strength scatter with MS-PFA from test, one concludes that the uncertainties defined are valid for use in laminate level simulation of notched or un-notched specimens. If the scatter produced from simulation is not accurate, other physical random variables can be included in the analysis while iterating on the COV to match the scatter at the lamina level.

The virtual test samples data produced by MS-PFA are run with STAT-17 [2] to determine A- and B-basis values. **Table 7** compares the A- and B-basis values from the 55 samples generated

by MS-PFA to those reported in reference [7]. The samples generated virtually by MS-PFA are analyzed using STAT-17 to determine A- and B-basis values. The results obtained from STAT-17 for MS-PFA samples met the normality criterion. Note that the allowables reported in [7] for TT and IPS tests were obtained using ANOVA method (a very conservative criterion). The advantage of simulation lies in its capability of providing alternate approach to avoid unreasonable allowable strength values when CMH-17 criteria are not met.

Lamina	Test Mean	MS-PFA Mean	Test Report [7]	MS-PFA*	% Diff
Test	Strength (ksi)	Strength (ksi)	A-Basis (ksi)	A-Basis (ksi)	w.r. [7]
LT	274.78	275.18	234.76	224.01	-4.58%
LC	203.53	203.38	168.23	172.55	2.57%
TT	6.92	7.05	0.48**	3.68	N/A
TC	26.81	25.36	21.61	21.71	0.46%
IPS	9.36	8.76	4.97**	7.61	N/A
Lamina	Test Report [7]	MS-PFA	% Diff		
Test	B-Basis (ksi)	B-Basis (ksi)	w.r. [7]		
LT	250.71	245.80	-1.96%		
LC	182.47	185.68	1.76%		
TT	0**	5.12	N/A		
TC	24.26	23.27	-4.08%		
IPS	6.8**	8.10	N/A		

* Randomly generated with MS-PFA then used as input to STAT-17 (Normal)

**Reference [7] used ANOVA method to report allowables

Table 7. Validation of MTM45-1 145 AS4 Lamina Level Allowables Obtained Using Virtual Test Samples by MS-PFA (Simulated Samples are Inputed to STAT-17)

Table 8 lists lamina level allowables obtained from simulated CDF at 0.01 probability for A-basis and at 0.10 probability for B-basis are compared to those reported in reference [7]. Overall, generating samples randomly with MS-PFA and processed with STAT-17 produce similar allowables to those obtained from a CDF for the given ASTM test. However, the CDF curve would depict more stable allowables as it is not dependent on tolerance factors. Next, results obtained for laminate level allowables are presented and discussed.

Lamina	Test Mean	MS-PFA Mean	Test [7]	MS-PFA*	Difference
Test	Strength (ksi)	Strength (ksi)	A-Basis (ksi)	A-Basis (ksi)	w.r.t [7]
LT	274.78	275.18	234.76	229.91	-2.07%
LC	203.53	203.38	168.23	175.17	4.13%
TT	6.92	7.05	0.48**	4.04	N/A
TC	26.81	25.36	21.61	22.32	3.29%
IPS	9.36	8.76	4.97**	7.93	N/A
Lamina	Test [7]	MS-PFA	Difference		
Test	B-Basis (ksi)	B-Basis (ksi)	w.r.t [7]		
LT	250.71	249.91	-0.32%		
LC	182.47	187.11	2.54%		
TT	0**	5.28	N/A		
TC	24.26	23.27	-4.08%		
IPS	6.8**	8.29	N/A		

* Obtained from CDF of Probabilistic Strength (A-basis at 0.10 Probability; B-basis at 0.1 Probability)

**Reference [7] reported use of ANOVA for this prediction

Table 8. Validation of MTM45-1 145 AS4 Lamina Level Allowables Obtained Using Virtual Test Samples by MS-PFA (A- and B-Basis Values are Obtained from CDF Curve at 0.01 and 0.1 Probabilities)

Strength Allowables for MTM45-1 145 AS4 (Laminate Level without use of Test Data)

A major contribution of the work presented here is the ability to use lamina level uncertainties to predict uncertainties for any laminate. Micro-scale uncertainties are infused to higher level structures of the FAA building block of **Figure 7**. The uncertainties derived in **Table 6** are used to determine A- and B-basis allowables for un-notched laminate specimens for two layups: $[0/90]_s$ and quasi-isotropic (25% 0° plies, 50% $\pm 45^\circ$ plies, and 25% 90° plies). The allowables were obtained with MS-PFA for tension and for compression loading conditions. **Figure 8** shows plots of the CDF of strength determined using the same uncertainties used in the lamina level simulation. **Table 9** lists the values for A- and B-basis obtained from MS-PFA simulation and from reference [7] using standard methods.

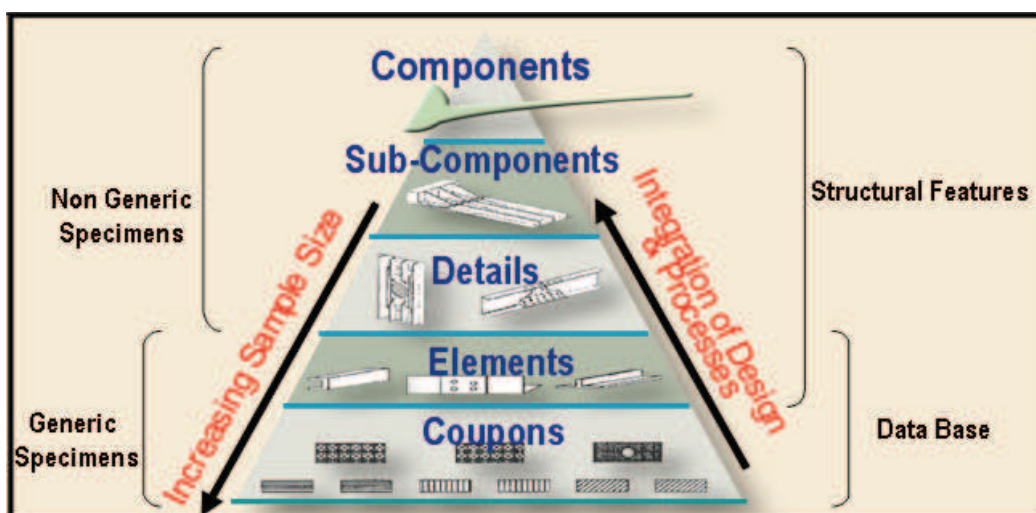
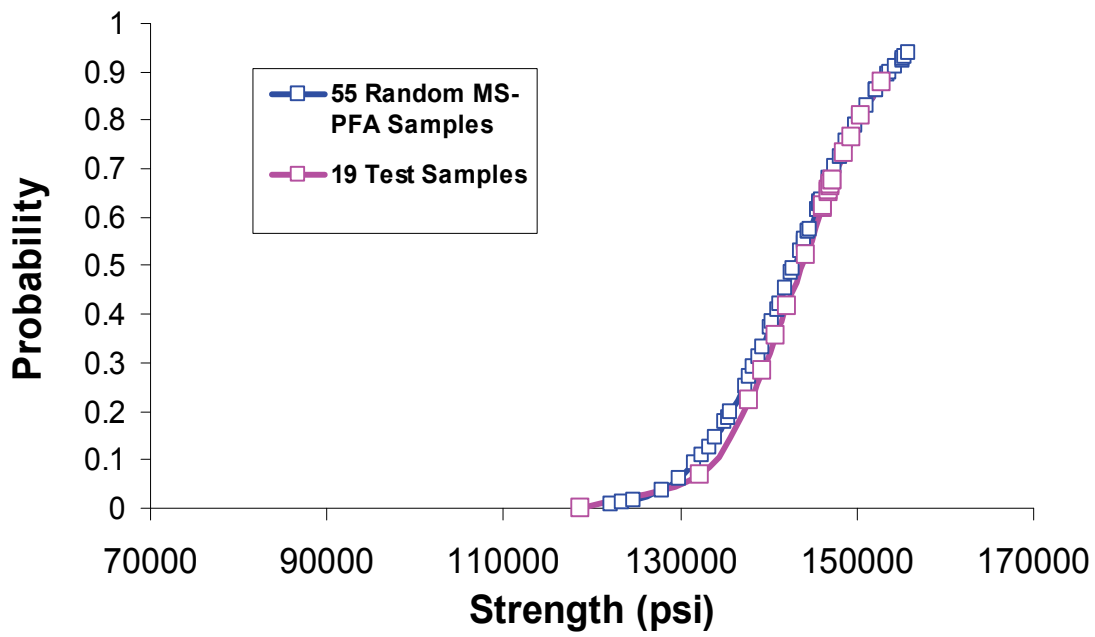
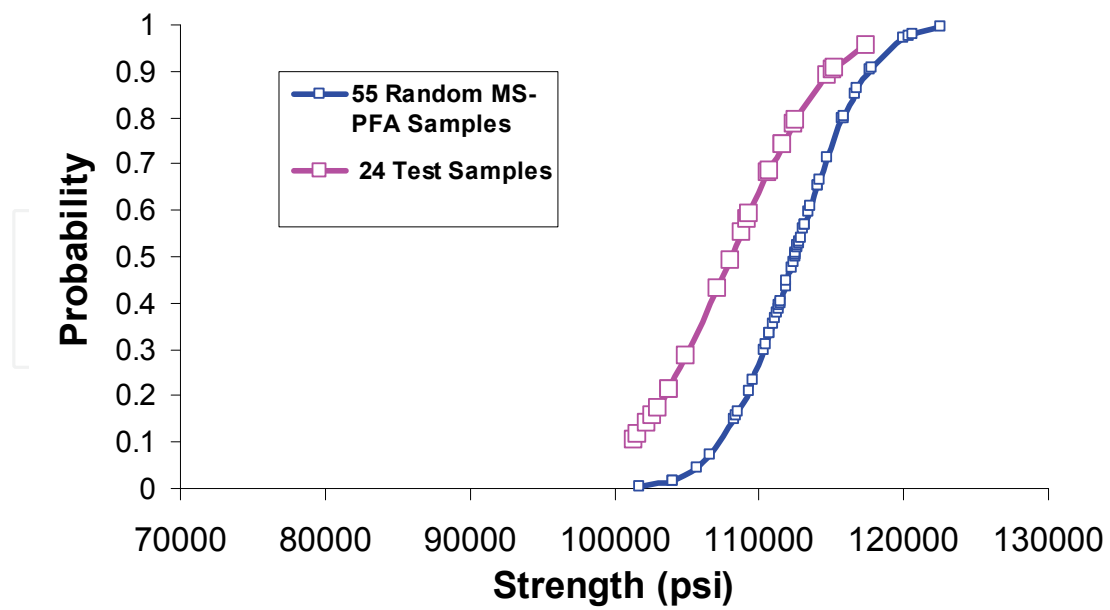

Fig. 7. FAA Building Block Validation with Generic and Non-Generic Specimens Depicting Multi-Scale and Multi-Level Integration of Structural Parts

In **Figure 8**, strengths from physical testing are plotted alongside the strengths generated with MS-PFA. This is done to illustrate the degree of fitness of simulated data compared to test. The allowables values listed in **Table 9** are obtained from simulation using the uncertainties of **Table 6** and assuming data from physical testing are not available. **Figure 9** shows the probabilistic sensitivities of random variables for the quasi-isotropic laminate. The sensitivity analysis ranks the random variables by order of influence on the laminate strength response. This is done by identifying the “root cause” for composite damage and failure. Controlling variability in the influential random variables reduces scatter in laminate strength response. As can be concluded from **Figure 9**, the transverse tensile strain EPS22T is the most predominant uncertainty followed by fiber volume ratio, FVR. Note that for laminate level specimens, a strain failure criteria is used for ply failure analysis in MS-PFA while for lamina level specimens, strength based criteria were used. The random variable statistics remain unchanged as the evaluation moved from lamina level to laminate level. Strain limits used as fracture criteria for laminate analysis are derived from lamina analysis and the reverse engineering process of fiber and matrix properties discussed earlier (**Table 3** and **Table 4**).



(a) MS-PFA Samples Compared to Test for 0/90 MTM45-1 145 AS4 Un-notched Tension



(b) MS-PFA Samples Compared to Test for 0/90 MTM45-1 145 AS4 Un-notched Compression

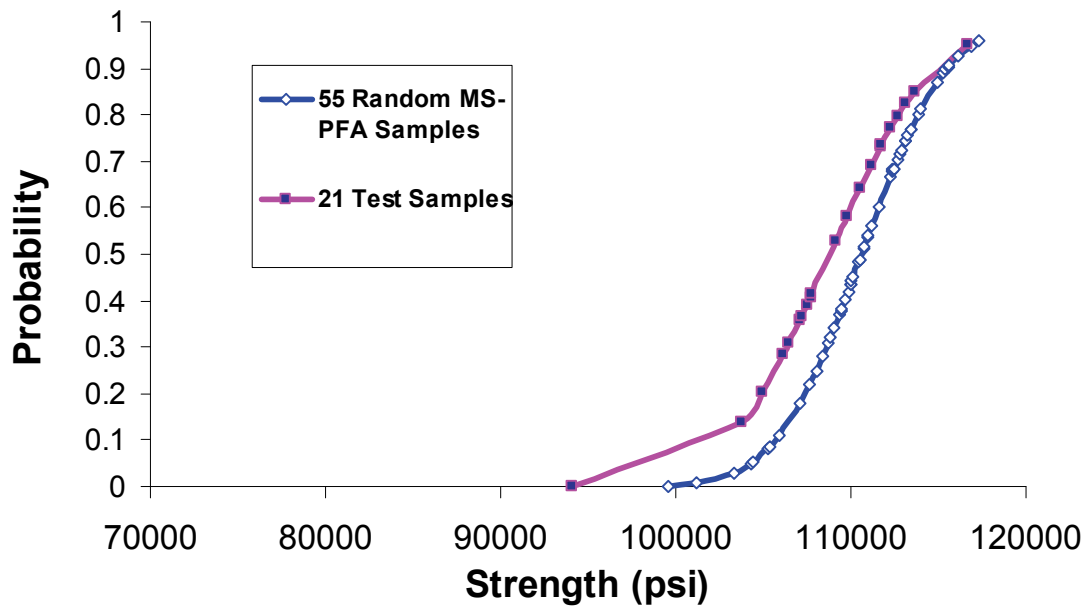

(c) MS-PFA Samples Compared to Test for MTM45-1 145 AS4 Quasi Isotropic Un-notched Tension

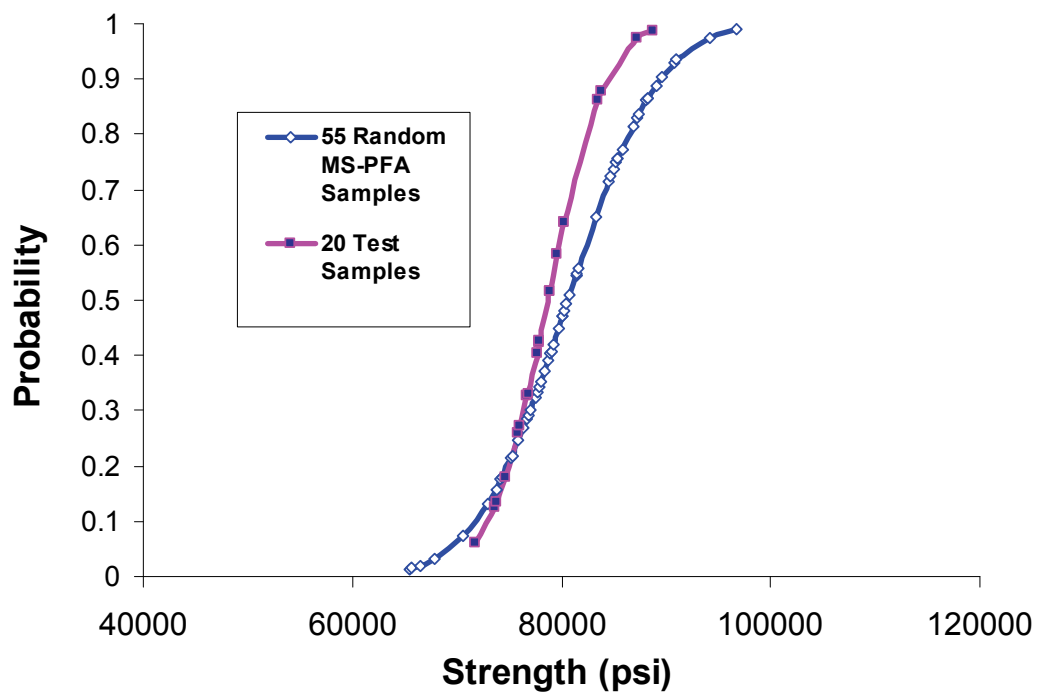

(d) MS-PFA Samples Compared to Test for MTM45-1 145 AS4 Quasi Isotropic Un-notched Compression

Fig. 8. Scatter in Laminate Level Failure Stress for MTM45-1 145 AS4 0/90 and Quasi Un-notched Specimens Generated by MS-PFA Simulation Compared to Test Data [7]

Test Type	Test Mean	MS-PFA Mean	Test [7]	MS-PFA*	Difference
Un-Notched	Strength (ksi)	Strength (ksi)	A-Basis (ksi)	A-Basis (ksi)	w.r.t [7]
0/90 Tensile	143.74	142.96	122.82	125.87	2.48%
0/90 Compressive	108.07	112.47	89.71	91.30	1.77%
Quasi Tensile	108.82	110.62	95.35	99.80	4.67%
Quasi Compressive	78.81	80.62	68.51	61.15	-10.74%
Test Type	Test[7]	MS-PFA	Difference		
Un-Notched	B-Basis (ksi)	B-Basis (ksi)	w.r.t [7]		
0/90 Tensile	131.16	129.20	-1.49%		
0/90 Compressive	97.09	104.02	7.14%		
Quasi Tensile	100.83	104.41	3.55%		
Quasi Compressive	72.63	69.44	-4.39%		

* Randomly generated then used as input to STAT-17 (Normal)

Table 9. Validation of MTM45-1 145 AS4 Laminate Level Allowables Obtained Using Virtual Test Samples by MS-PFA (Simulated Samples are Input to STAT-17)

The effect of sample size on A- and B-basis predictions is presented in **Figure 10** for the quasi-isotropic laminate under tension loading. MS-PFA was used to generate 55, 100 and 1000 samples. The predictions improved with the use of increased number of samples as compared to the 21 physical tests reported in reference [7]. The A and B-basis values for different random sample size are listed in **Table 10**. The randomly generated samples were fitted to normal distribution. Evaluating these virtual samples with STAT-17 yielded the A- and B-basis values presented in **Table 10**. As more virtual samples were generated, the mean value approached the real mean from the 21 physical tests. Data presented in **Table 10** establishes confidence in the computational approach, especially to the stability of data obtained from virtual simulation. Next, validation of allowables for IM7/MTM45-1 with reduced testing is presented and discussed.

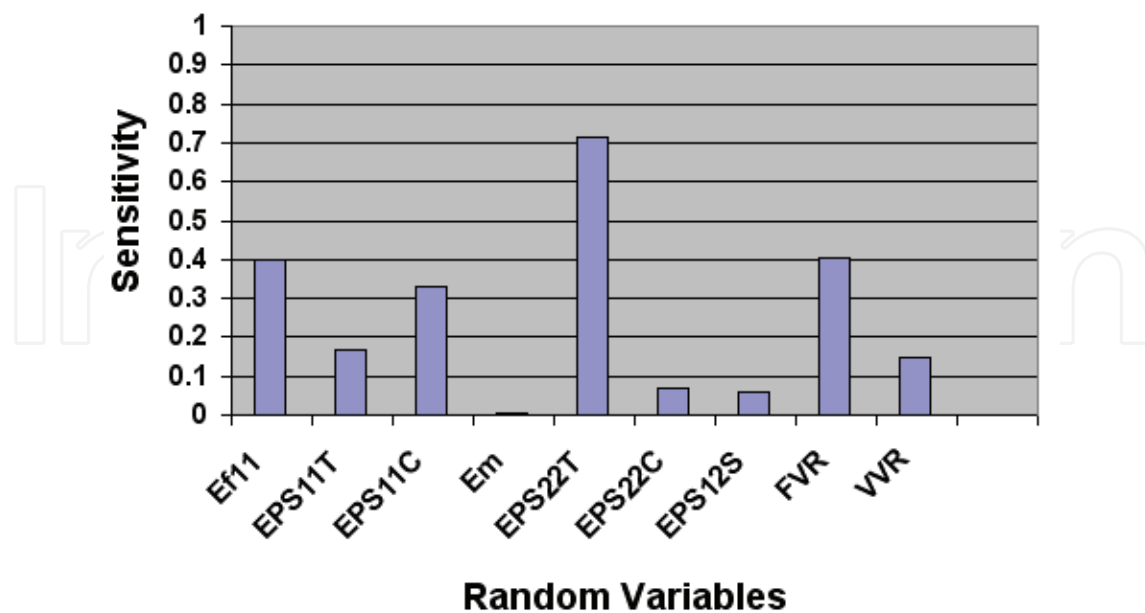

Fig. 9. Sensitivity of Random Variables for MTM45-1 145 AS4 Quasi Un-notched Laminate (Tension Loading)

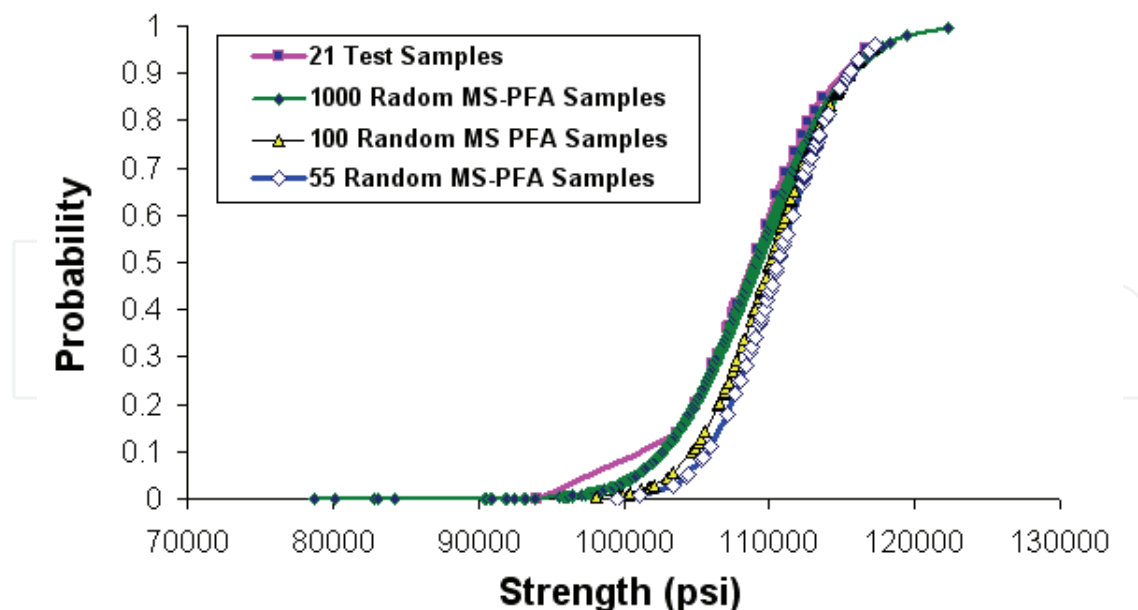

Fig. 10. Effect of Number of Virtual Samples on Strength of MTM45-1 145 AS4 Quasi Un-notched Laminate (Tension Loading)

Test Type Un-Notched	Mean	A-Basis	B-Basis
	Strength (ksi)	Strength (ksi)	A-Basis (ksi)
21 Test Samples [7]	108.82	95.34	100.83
55 Virtual Samples	110.62	99.80	104.41
100 Virtual Samples	110.09	98.85	103.66
1000 Virtual Samples	109.15	96.90	102.32
Difference w.r.t. tests [6]			
55 Virtual Samples	1.65%	4.68%	3.55%
100 Virtual Samples	1.16%	3.68%	2.81%
1000 Virtual Samples	0.31%	1.64%	1.48%

Table 10. Effect of Number of Virtual Samples on Determination of A- and B-Basis for MTM45-1 145 AS4 Quasi Un-Notched Laminate (Tension Loading)

B-Basis Strength Allowables for IM7/MTM45-1 (Sealed Envelope Prediction)

To further affirm the validity of the approach for generating allowables with reduced testing, Northrop Grumman Corporation (NGC) provided data for IM7/MTM45 composite for use in a “sealed envelope” process [8]. Using statistics provided by NGC for lamina level testing, B-basis values were calculated for notched and un-notched laminates using the approach proposed in this document to reduce laminate level testing. NGC provided one third of the laminate level test data usually used in the generation of allowables. Independent of full test results, predictions were made and handed to NGC for comparison against a “sealed envelope” of real test data. B-basis tensile strength values for un-notched and notched IM7/MTM45-1 coupons were predicted (using a reduced number of test replicates) and provided to NGC. Predicted results were compared to those obtained using standard military specification practices and the standard number of test replicates. The

difference in the B-basis results obtained from prediction and those from current practices ranged from -5.31% and 5.34%. **Figure 11** shows the steps followed to compute B-basis values for the various coupons starting with a reduced number of test replicates. The number of replicates varied from 3 to 6 as listed in **Table 11**. The same table compares MS-PFA B-basis predictions to those obtained using traditional methods and all available replicates [9-10]. The B-basis values from the references were not made available until after computational allowables were derived. The B-basis predictions were obtained with MS-PFA using a unique set of prescribed uncertainties of the following random variables: fiber tensile strength, matrix tensile strength, matrix shear strength, fiber volume ratio, and void volume ratio. The uncertainties were derived from the lamina level testing for IM7/MTM45 Open hole tension (OHT) coupon simulations showed errors in predicted mean tensile strength ranging from -12.7% to 8.88% compared to true average from test. The difference

Coupon Type	Lamina	B-basis (ksi)	B-basis (ksi)	Difference
Un-Notched Tension RTD	Proportions	MS-PFA	CMH17 [2]	w.r.t. [2]
	[50-0-50]	156.22	158.54	-1.46%
	[25-50-25]	112.98	119.32	-5.31%
Un-Notched Compression RTD	[10-80-10]	69.09	65.59	5.34%
	[50-40-10]	173.41	178.4	-2.80%
	[25-50-25]	59.4	62.15	-4.42%
	[10-80-10]	41.59	41.67	-0.19%
	[50-40-10]	98.13	100.63	-2.48%

Table 11. Un-Notched and Notched B-Basis Strength Predictions for IM7/MTM45 (Tension Loading)

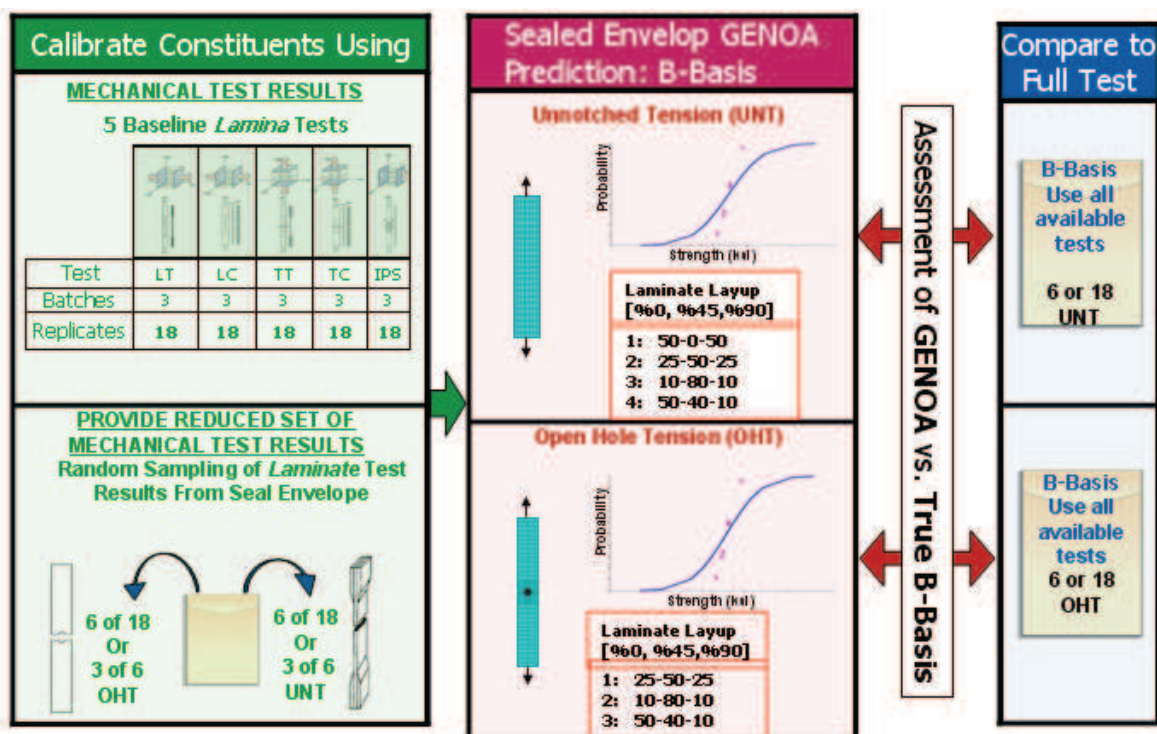

Fig. 11. Process Used for Computing B-Basis Values for Various IM7/MTM45 Coupons Starting with a Reduced Number of Test Replicates

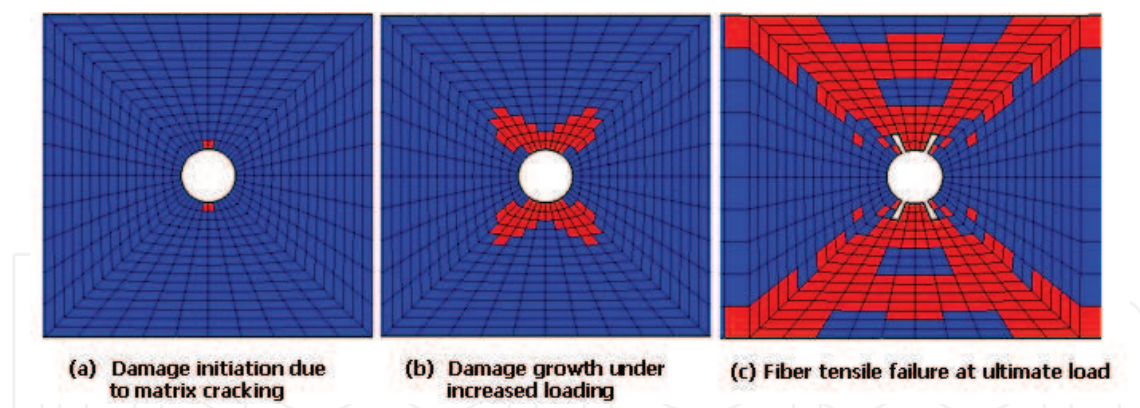

Fig. 12. Damage Initiation, Damage Growth and Fracture in Quasi OHT Made from IM7/MTM45 (Red Indicates Material Damage)

between simulation and test averages were addressed using Bayesian statistics update where CDF from simulation was corrected with the 6 few tests that were available. Animation of damage at the initiation stage and progression up to ultimate failure for the quasi open hole coupon under tension loading is presented in **Figure 12**. MS-PFA [4] identified critical damage evolution events isolating plies and elements contributing to the failure.

A- and B-Basis Validation for Open Hole Tension (OHT) T300/PPS Thermoplastic

To further demonstrate the validity of the MS-PFA approach for determination of allowables with reduced testing, A- and B-basis predictions were made for an open hole specimen under tension loading [11,12]. The specimen was fabricated from T300 carbon PPS thermoplastic composite material in a woven configuration with $[\pm 45/(0/90)]_{3S}$ layup. First, MS-PFA was used to reverse engineer the constituent properties from lamina level LT, LC, TT, TC and IPS tests. Second, uncertainties in fiber and matrix properties and fabrication parameters were assumed since lamina level statistics for the T300/PPS material were not available. Unknown COV's can be obtained from existing databases of comparable or similar materials or from experience based on anticipated scatter. **Table 12** lists the

Test #	Failure Load	Test #	Failure Load
1	0.9218	16	1.0008
2	0.9507	17	1.0027
3	0.9593	18	1.0027
4	0.9690	19	1.0065
5	0.9709	20	1.0065
6	0.9728	21	1.0065
7	0.9853	22	1.0143
8	0.9853	23	1.0143
9	0.9892	24	1.0268
10	0.9950	25	1.0287
11	0.9950	26	1.0335
12	0.9960	27	1.0335
13	0.9979	28	1.0393
14	0.9979	29	1.0470
15	0.9998	30	1.0510

Table 12. Normalized Tensile Failure Load for T300/PPS Open Hole Composite Coupon

Property	COV
Fiber longitudinal modulus	5%
Fiber longitudinal tensile strength	5%
Matrix modulus	5%
Matrix tensile strength	5%
Matrix shear strength	5%
Fiber volume fraction	5%
Void volume fraction	5%

Table 13. Random Variables Used in Predicting A- and B-Basis Allowables for T300/PPS

normalized failure load from the test for the OHT case. The range of the failure load varied from 0.9218 to 1.051 with a standard deviation of 0.028. **Table 13** lists the assumed random variables for use in the prediction of allowables. Initial COV of 5% was assumed for all random variables.

MS-PFA was used in conjunction with probabilistic analysis to replicate the scatter in the failure strength for the OHT coupon. The random variables were selectively perturbed by the analysis engine to populate enough data to predict the cumulative distribution of the failure stress. As indicated in **Figure 13**, the scatter from simulation did not agree with that from test when a coefficient of 5% was applied uniformly to all random variables. However, reducing the coefficient of variation to 1% for the fiber and matrix stiffness and strength and the fabrication variables, yielded an excellent agreement with test (**Figure 14**). If test data did not exist to calibrate the COV's of the constituent properties and fabrication parameters, one can assume a 5% value as a starting point. Sensitivity analysis can also be used to reduce the list of random variables to include those that are very influential (those with sensitivity higher than 10%).

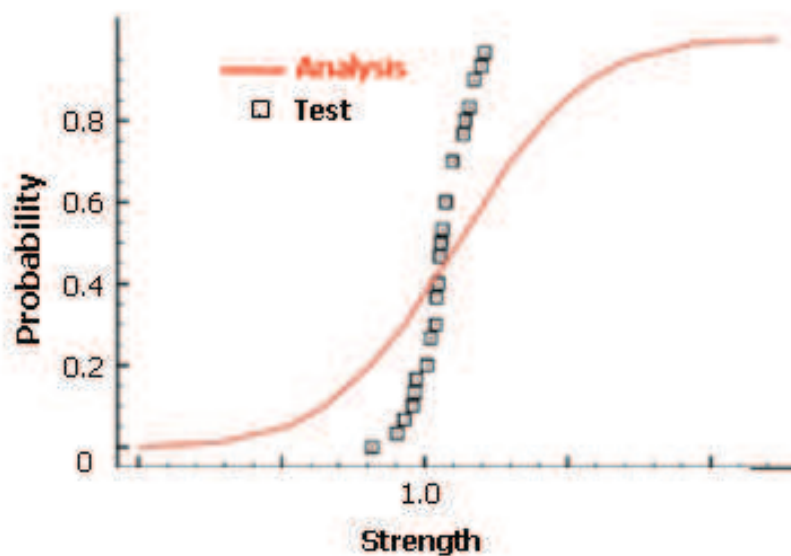

Fig. 13. Comparison of Scatter from Simulation and Test for T300/PPS OHT Strength With a Coefficient of Variation of 5%

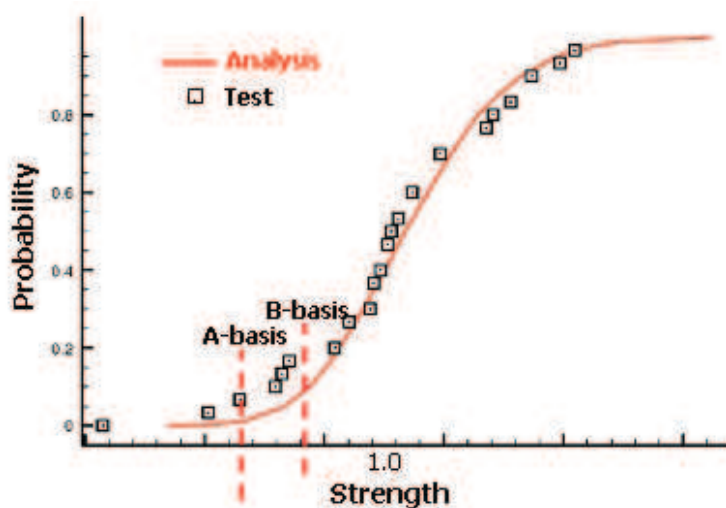

Fig. 14. Comparison of Scatter from Simulation and Test for T300/PPS OHT Strength With a Coefficient of Variation of 1%

Processing the 30 test data through STAT17 resulted in an A-basis value of 0.92 and a B-basis value of 0.9486 with respect to a mean normalized strength of 1.0. The CDF obtained from MS-PFA resulted in A-basis value of 0.9104 and a B-basis value of 0.959 when the strengths were retrieved at the 1/100 and 1/10 probabilities. The maximum error from the prediction with respect to test was 1.1% as shown in **Table 14**.

	Test (Mil-HDBK)	Analysis	% Error
A-Basis	0.92	0.9104	1.04%
B-Basis	0.9486	0.959	-1.10%

Table 14. Open Hole Tension Case Comparison of A- and B-Basis Values from Test and Analysis

Determination of A-Basis Values from B-Basis

As discussed earlier, accepted standards for determination of A-basis require physical testing of 55 specimens from 10 batches (as a minimum). Reference [13] listed strength data from testing of 145 specimens for 90° tension laminate made from T700 fibers and 2510 epoxy matrix. The MS-PFA approach was used to generate random samples to determine A-basis for the transverse tension laminate assuming only 18 test samples existed. Note that the 18 specimens is the minimum accepted standard [1,2] for B-basis determination. The 18 test specimens were obtained from a total 3 batches from [13], the data extracted were the first 18 test points reported in reference [13]. MS-PFA was then used to simulate the scatter for the 18 specimens and used to generate additional samples (55 and 145 random samples). The virtual test samples generated by MS-PFA used the statistics listed in **Table 15**.

Figure 15 shows a plot of the 18 test samples, 145 test samples, and 55 and 145 MS-PFA virtually generated test samples. The MS-PFA virtual samples fitted the 145 samples from physical test with great accuracy. The technical approach in MS-PFA can be used to generate virtual test samples not available thru physical testing. This is evident by the goodness of fit between simulated and test data and with the accurate calculation of A-basis as presented in **Table 16**.

Property	Mean	COV	Distribution
Ef11 (msi)	34.80	5.00%	Normal
Sf11T (ksi)	604.50	7.56%	Normal
Sf11C (ksi)	366.90	6.15%	Normal
Em (msi)	0.53	5.00%	Normal
SmT (ksi)	11.62	8.39%	Normal
SmC (ksi)	46.00	4.73%	Normal
SmS (ksi)	37.82	2.82%	Normal
FVR	0.53	2.50%	Normal
VVR	0.03	2.50%	Normal

Table 15. Random Variable Statistics for Determining A-Basis Strength from B-Basis for T700/2510 90° Tension Laminate

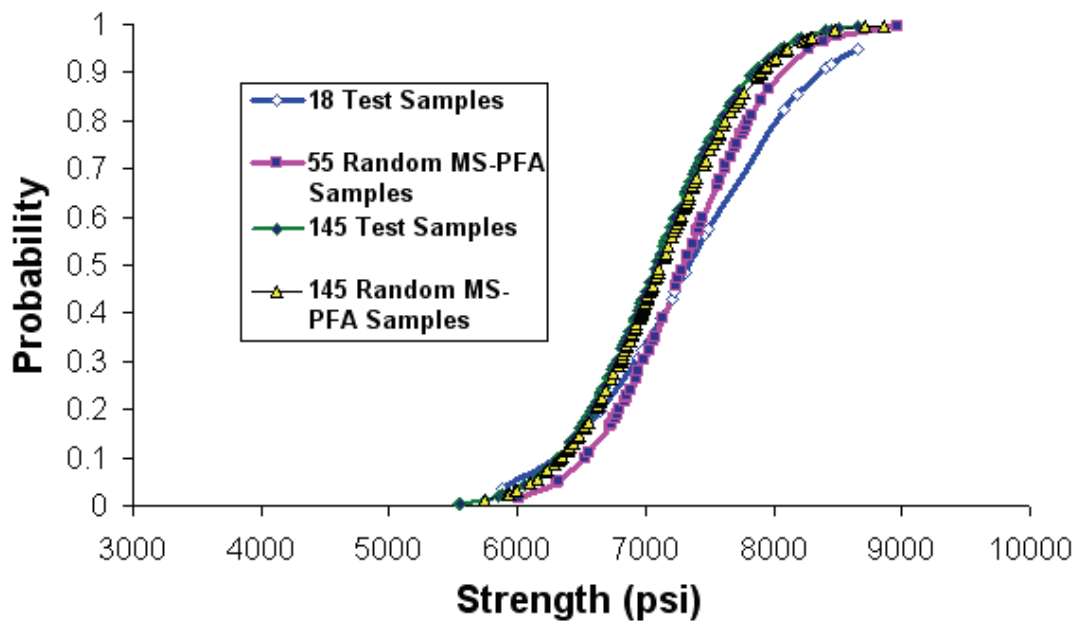

Fig. 15. Comparison of 18 and 145 tests to 55 and 145 MS-PFA Virtual Samples Used in Determining A-Basis Strength from B-Basis for T700/2510 90° Tension Laminate

Test Type	Mean	A-Basis	B-Basis
Un-Notched 90 Deg Tension	Strength (ksi)	Strength (ksi)	Strength (ksi)
18 Test Samples [12]	7341	4610	5741
145 Test Samples [12]	7083	5523	6200
55 Virtual Samples	7302	5603	6326
145 Virtual Samples	7121	5684	6258
Difference w.r.t. 145 Test Samples [13]			
55 Virtual Samples	3.09%	1.45%	2.03%
145 Virtual Samples	0.53%	2.92%	0.94%

Table 16. Determining A-Basis Strength from B-Basis for T700/2510 90° Tension Laminate

The referenced table lists A- and B-basis calculations obtained using the data from test and simulation after running STAT-17 with the generated virtual test samples. For each random sample generated, MS-PFA is executed to determine sample failure stress. **Table 16** also lists the mean strength from test and simulation. The mean strength value from 145 MS-PFA simulations was within about 0.5% of that from 145 physical test samples. The accuracy in predicting mean strength and A- basis values demonstrates the effectiveness of the devised methodology for determination of allowables with reduced testing.

5. Summary

A computational method has been presented for determining A and B-basis composite strength allowables with a significant reduction in testing over standard FAA and CMH-17 methods. The method combines multi-scale multi-physics progressive failure analysis (MS-PFA) with probabilistic methods and Bayesian updates. It was demonstrated for typical aerospace composite materials such as MTM45-1 145 AS4, IM7/MTM45-1, T300/PPS and T700/2510. Starting from lamina level coupon test data, root cause fiber and matrix properties, fabrication variables, and associated uncertainties are reverse engineered with MS-PFA for use in generation of strength allowables. MS-PFA is then used to virtually generate random laminate level test samples. In turn, the virtual test data are used to calculate allowable values for notched and un-notched composite laminate specimens. The methodology is robust and can be easily inserted into material characterization and qualification programs to yield a significant reduction in the number of physical tests at the laminate level. Additionally, the approach can be relied on to generate allowables for configurations (layups) that were not initially included in a test plan as long as the simulation results are verified with few tests that are representative of the over-all design envelope. Very importantly, the methodology was validated for typical aerospace composite laminates and calculated A and B-basis values compared very well with test.

6. References

- [1] Material Qualification and Equivalency for Polymer Matrix Composite Material Systems: Updated Procedure. DOT/FAA/AR-03/19, Office of Aviation Research, Washington, D.C. 20591, September 2003.
- [2] The Composite Materials Handbook CMH-17, <http://www.cmh17.org/>
- [3] R. Rice, R. Goode, J. Bakuckas, and S. Thompson, "Development of MMPDS Handbook Aircraft Design Allowables". 7th Joint DOD/FAA/NASA Conference on Aging Aircraft, September 2003, New Orleans, LA.
- [4] M. Garg, G. Abumeri and D. Huang, "Predicting Failure Design Envelop for Composite Material System Using Finite Element and Progressive Failure Analysis Approach". SAMPE 2008.
- [5] G. Abumeri, F. Abdi, M. Baker, M. Triplet and, J. Griffin, "Reliability Based Design of Composite Over-Wrapped Tanks". SAE World Congress, 2007, 07M-312, Detroit MI, April 2007.
- [6] J. Tomblin, and W. Seneviartne, "Laminate Statistical Allowable Generation for Fiber-Reinforced Composite Materials: Lamina Variability Method". Report number DOT/FAA/AR-06/53, January 2009. US Department of Transportation, Federal

- Aviation Administration (Office of Aviation Research and Development), Washington, DC.
- [7] E. Clarkson, "Advanced Composites Group MTM45-1 145 AS4 Unidirectional Tape Qualification Statistical Analysis Report", National Institute for Aviation Research, Wichita State University, 2009.
- [8] G. Abumeri, M. Garg, F. Abdi, A. McCloskey and R. Bohner, "Validation of a Computational Approach for Composite Material Allowables Using Sealed Envelope Predictions for Reduced Testing," *Sampe Journal*, Sep/Oct 2009.
- [9] A. Crocket, "Advanced Composites Group MTM45-1 IM7-145 32%RW 12K IM7 Unidirectional, 145 gsm Qualification Material Property Data Report", National Institute for Aviation Research, Wichita State University, December 4, 2008.
- [10] E. Clarkson, Y. Ng, and J. Tomblin, "B-Basis Values and Estimates for ACG Material MTM45-1/IM7-145gsm-32R%W", National Institute for Aviation Research/NCAMOP, Wichita State University, October 2008.
- [11] M. Talagani, F. Abdi, and S. Verhoef, "Obtaining A-basis and B-basis Values for Open Hole Specimens Using Virtual Testing", 4th Ankara International Aerospace Conference, September 2007-METU, AIAC,-2007-127, Ankara, Turkey.
- [12] G. Abumeri and M. Garg, and M. Talagani, "A Computational Approach For Predicting A- And B-Basis Allowables For Polymer Composites", SAMPE 40th ISTC - Memphis, TN - Sep 2008.
- [13] J. Tomblin, J. Sherraden, W. Seneviratne, and K. S. Raju, "A-Basis and B-Basis Design Allowables for Epoxy - Based Prepreg, TORAY T700GC-12K-31E/#2510 Unidirectional Tape AGATE-WP3.3-033051-132", NIAR, Wichita State University, Wichita, KS, Nov 2002.

IntechOpen

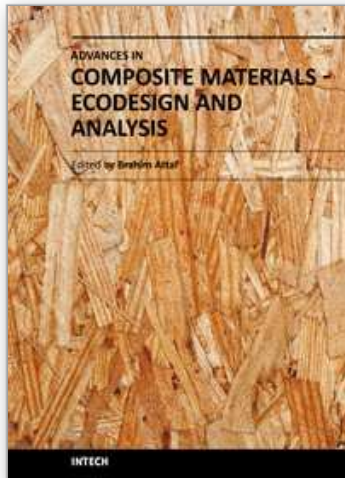

Advances in Composite Materials - Ecodesign and Analysis

Edited by Dr. Brahim Attaf

ISBN 978-953-307-150-3

Hard cover, 642 pages

Publisher InTech

Published online 16, March, 2011

Published in print edition March, 2011

By adopting the principles of sustainable design and cleaner production, this important book opens a new challenge in the world of composite materials and explores the achieved advancements of specialists in their respective areas of research and innovation. Contributions coming from both spaces of academia and industry were so diversified that the 28 chapters composing the book have been grouped into the following main parts: sustainable materials and ecodesign aspects, composite materials and curing processes, modelling and testing, strength of adhesive joints, characterization and thermal behaviour, all of which provides an invaluable overview of this fascinating subject area. Results achieved from theoretical, numerical and experimental investigations can help designers, manufacturers and suppliers involved with high-tech composite materials to boost competitiveness and innovation productivity.

How to reference

In order to correctly reference this scholarly work, feel free to copy and paste the following:

G. Abumeri, F. Abdi, K.S. Raju, J. Housner, R. Bohner and A. McCloskey (2011). Cost Effective Computational Approach for Generation of Polymeric Composite Material Allowables for Reduced Testing, *Advances in Composite Materials - Ecodesign and Analysis*, Dr. Brahim Attaf (Ed.), ISBN: 978-953-307-150-3, InTech, Available from: <http://www.intechopen.com/books/advances-in-composite-materials-ecodesign-and-analysis/cost-effective-computational-approach-for-generation-of-polymeric-composite-material-allowables-for->

INTECH
open science | open minds

InTech Europe

University Campus STeP Ri
Slavka Krautzeka 83/A
51000 Rijeka, Croatia
Phone: +385 (51) 770 447
Fax: +385 (51) 686 166
www.intechopen.com

InTech China

Unit 405, Office Block, Hotel Equatorial Shanghai
No.65, Yan An Road (West), Shanghai, 200040, China
中国上海市延安西路65号上海国际贵都大饭店办公楼405单元
Phone: +86-21-62489820
Fax: +86-21-62489821

© 2011 The Author(s). Licensee IntechOpen. This chapter is distributed under the terms of the [Creative Commons Attribution-NonCommercial-ShareAlike-3.0 License](#), which permits use, distribution and reproduction for non-commercial purposes, provided the original is properly cited and derivative works building on this content are distributed under the same license.

IntechOpen

IntechOpen