

# We are IntechOpen, the world's leading publisher of Open Access books Built by scientists, for scientists

**4,800**

Open access books available

**122,000**

International authors and editors

**135M**

Downloads

Our authors are among the

**154**

Countries delivered to

**TOP 1%**

most cited scientists

**12.2%**

Contributors from top 500 universities



**WEB OF SCIENCE™**

Selection of our books indexed in the Book Citation Index  
in Web of Science™ Core Collection (BKCI)

Interested in publishing with us?  
Contact [book.department@intechopen.com](mailto:book.department@intechopen.com)

Numbers displayed above are based on latest data collected.

For more information visit [www.intechopen.com](http://www.intechopen.com)



# Trends of the Optical Wireless Communications

Juan-de-Dios Sánchez- López<sup>1</sup>, Arturo Arvizu M<sup>2</sup>,  
Francisco J. Mendieta<sup>2</sup> and Iván Nieto Hipólito<sup>1</sup>

<sup>1</sup>Autonomous University of Baja California,

<sup>2</sup>Cicese Research Center

México

## 1. Introduction

The Optical Wireless Communications (OWC) is a type of communications system that uses the atmosphere as a communications channel. The OWC systems are attractive to provide broadband services due to their inherent wide bandwidth, easy deployment and no license requirement. The idea to employ the atmosphere as transmission media arises from the invention of the laser. However, the early experiments on this field did not have any baggage of technological development (like the present systems) derived from the fiber optical communications systems, because like this, the interest on them decreased (Willebrand, 2002). At the beginning of the last century, the OWC systems have attracted some interest due to the advantages mentioned above. However, the interaction of the electromagnetic waves with the atmosphere at optical frequencies is stronger than that corresponding at microwave. (Wheelon, 2002)

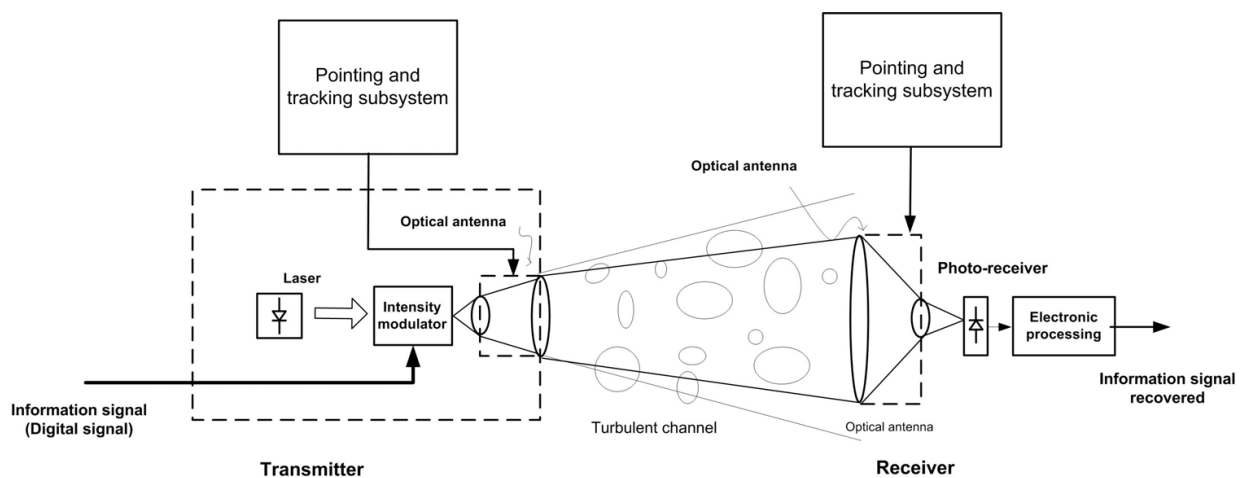

Fig. 1. Model of a typical atmospheric optical communications link

The intensity of a laser beam propagating through the atmosphere is reduced due to phenomena such as scattering and molecular absorption, among other (Willebrand, 2002). The changes in the refractive index of the atmosphere due to optical turbulence affect the quality of laser beam through distortion of its phase front and random modulation of its optical power (Zsu, 2002). Also the presence of fog may completely prevent the passage of the optical beam that leads to a no operational communications link (Kedar, 2003).

The figure 1 shows the block diagram of an OWC communications system (also called Free Space optic communications system or FSO) (Zsu, 2002). The information signal (analog or digital) is applied to the optical transmitter to be sent through the atmosphere using an optical antenna. At the receiver end the optical beam is concentrated, using an optical antenna, to the photo-detector sensitive area, which output is electrically processed in order to receiver the information signal.

## 2. Important access technologies (first and last mile)

In the past decades, the bandwidth of a single link in the backbone of the networks has been increased by almost 1000 times, thanks to the use of wavelength division multiplexing (WDM) [Franz, 2000]. The existing fiber optic systems can provide capabilities of several gigabits per second to the end user. However, only 10% of the businesses or offices, have direct access to fiber optics, so most users who connect to it by other transmission technologies which use copper cables or radio signals, which reduces the throughput of these users. This is a bottleneck to the last mile (Zsu, 2002).

While there are communication systems based on broadband DSL technology or cable modems, the bandwidth of these technologies is limited when compared against the optical fiber-based systems (Willebrand, 2002). In the other hand, the RF systems using carrier frequencies below the millimeter waves can not deliver data at rates specified by IEEE 802.3z Gbit Ethernet. Rates of the 1 Gbps and higher can only be delivered by laser or millimeter-wave beams. However, the millimeter wave technology is much less mature than the technology of lasers (Willebrand, 2002), which leaves the optical communications systems as the best candidates for this niche market. Therefore, the access to broadband networks based on optical communications may be accomplished through passive optical networks (or PON's, which are based on the use of fiber optics) or via optical wireless communication systems (Qingchong, 2005).

The optical wireless communications industry has experienced a healthy growth in the past decade despite the ups and downs of the global economy. This is due to the three main advantages over other competing technologies. First, the wireless optical communications cost is on average about 10% of the cost of an optical fiber system (Willebrand, 2002). It also requires only a few hours or weeks to install, similar time to establish a radio link (RF), while installing the fiber optics can take several months. Second, OWC systems have a greater range than systems based on millimeter waves. OWC systems can cover distances greater than a kilometer, in contrast with millimeter-wave systems that require repeaters for the same distance. In addition, millimeter wave systems are affected by rain, but the OWC systems are affected by fog, which makes complementary these transmission technologies (Qingchong, 2005). Finally, this type of technology as opposed to radio links, does not require licensing in addition to not cause interference.

### 2.1 Applications of the OWC systems

Optical wireless communications systems have different applications areas:

#### a. Satellite networks

The optical wireless communications systems may be used for in satellite communication networks, satellite-to-satellite, satellite-to-earth (Hemmati et al, 2004).

#### b. Aircraft

In applications satellite to aircraft or the opposite (Lambert et al, 1995).

## c. Deep Space

In the deep space may be used for communications between spacecraft - to - earth or spacecraft to satellite. (Hemmati et al, 2004).

## d. Terrestrial (or atmospheric) communications

In terrestrial links are used to support fiber optic, optical wireless networks "wireless optical networks (WON)" last mile link, emergency situations temporary links among others (Zsuand & Kahn, 2002).

Each application has different requirements but this book chapter deals primarily with terrestrial systems.

## 2.2 Basic scheme of OWC systems communications

Optical communications receivers can be classified into two basic types. (Gagliardi & Karp, 1995): non-coherent receivers and coherent receivers. Noncoherent detect the intensity of the signal (and therefore its power). This kind of receivers is the most basic and are used when the information transmitted is sent by the variations in received field strength. On the other hand are coherent receivers, in which the received optical field is mixed with the field generated by a local optical oscillator (laser) through a beam combiner or coupler, and the resulting signal is photo-detected.

### 2.2.1 Noncoherent optical communications systems

The commercially deployed OWC systems use the intensity modulation (IM) that is converted into an electrical current in the receiver by a photodetector (usually are a PIN diode or an avalanche photo diode (APD)) which is known as direct detection (DD).

This modulation scheme is widely used in optical fiber communications systems due to its simplicity.

In IM-DD systems, the electric field of light received,  $E_s$  is directly converted into electricity through a photoreceiver, as explained above. The photocurrent is proportional to the square of  $E_s$  and therefore the received optical power  $P_r$ , i.e.:

$$i(t) = \frac{e\eta}{h\nu} E_s^2(t) \quad (1)$$

where  $e$  is the electronic charge,  $\eta$  is the quantum efficiency,  $h$  is Planck's constant,  $\nu$  is the optical frequency. The block diagram of the system is shown in Figure 2.

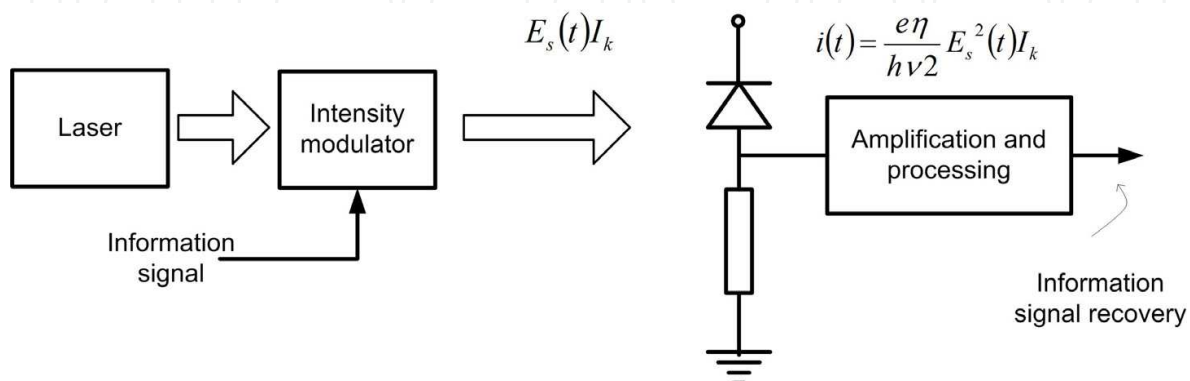

Fig. 2. Block diagram using an optical communication system of intensity modulation and direct detection (noncoherent)

The optical direct detection can be considered as a simple process of gathering energy that only requires a photodetector placed in the focal plane of a lens followed by electronic circuits for conditioning the electrical signal derived from the received optical field (Franz & Jain, 2000).

### 2.2.2 Coherent optical communications systems

In analog communications in the radio domain [Proakis, 2000, Sklar, 1996], the coherent term is used for systems that recover the carrier phase. In coherent optical communications systems, the term "coherent" is defined in a different way: an optical communication system is called coherent when doing the mixing of optical signals (received signal and the signal generated locally) without necessarily phase optical carrier recovered [Kazovsky, 1996]. Even if it does not use the demodulator carrier recovery but envelope detection, the system is called coherent optical communication system due to the mixing operation of the optical signals. In turn, the coherent receivers can be classified into two types: asynchronous and synchronous. They are called synchronous when the tracking and recovering of the carrier phase is performed and asynchronous when is not performed the above mentioned process. The asynchronous receivers typically use envelope detection (Kazovsky, 1996), (Franz & Jain, 2000) Figure 3 shows the basic structure of a communications system with digital phase modulation and coherent detection. The output current of the photodetectors array is:

$$i(t) = \Re \frac{E_s^2(t)}{2} + \Re \frac{E_{LO}^2(t)}{2} + \Re \sqrt{E_s(t)E_{LO}} \cos\{[\omega_{LO} - \omega_s]t + \phi_{LO} - \phi_s\} \quad (2)$$

where  $\Re = en/h\nu$  is the responsivity,  $E_{LO}$  is the electric field generated by the laser that operates as a local oscillator,  $\omega_{LO}$  is the frequency of the local oscillator and  $\omega_s$  is the carrier frequency of the optical received signal  $\phi_{LO}$  is the phase of the carrier signal received, and  $\phi_s$  is the carrier phase of the received optical signal. The coherent mixing process requires that the local beam to be aligned with the beam received in order to get efficient mixing. This can be implemented in two different ways; if the frequency of signal and local oscillator are different and uncorrelated the process is referred to as heterodyne detection (Fig. 4) (Osche, 2002); if the frequencies of the signal and local oscillator are the same and are correlated, is

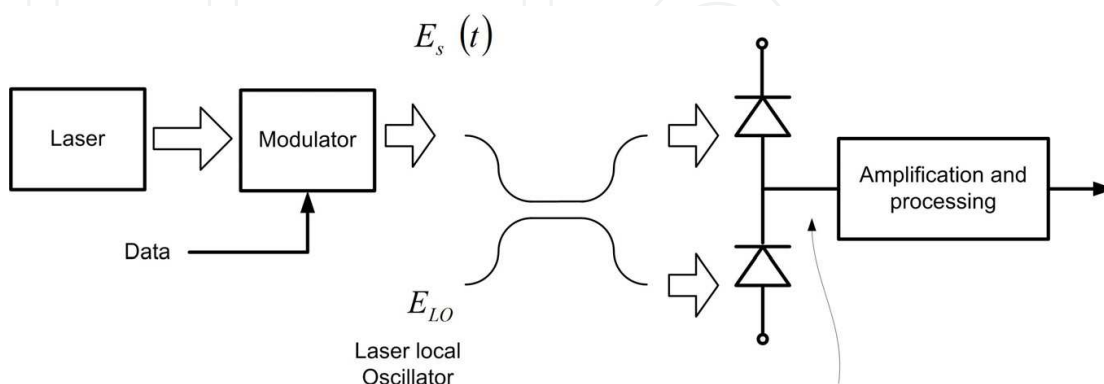

$$i(t) = \Re \frac{E_s^2(t)}{2} + \Re \frac{E_{LO}^2(t)}{2} + \Re \sqrt{E_s(t)E_{LO}} \cos\{[\omega_{LO} - \omega_s]t + \phi_{LO} - \phi_s\}$$

Fig. 3. Optical Communication System with coherent detection

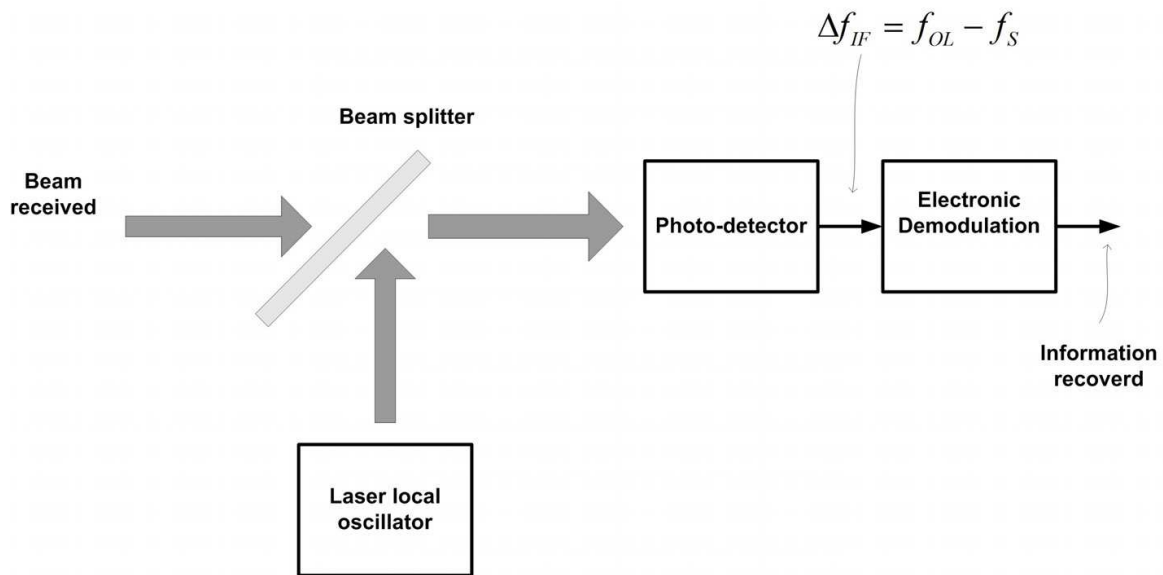

Fig. 4. Optical heterodyne receiver

called homodyne detection (Fig. 5) (Osche, 2002). Due to the process of mixing, coherent receivers are theoretically more sensitive than direct detection receivers (Kazovsky, 1996).

In terms of sensitivity, the coherent communications systems with phase modulation, theoretically have the best performance of all (e.g. BPSK is about 20 dB better than OOK). Sensitivity is the number of photons per bit required to get a given probability of error (Kazovsky 1996).

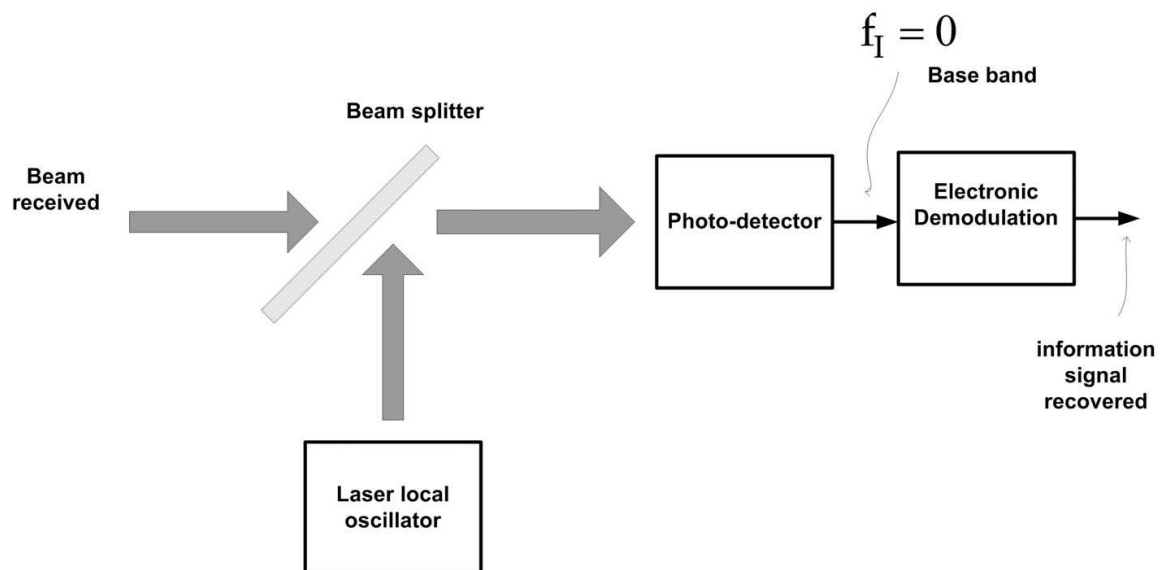

Fig. 5. Optical homodyne receiver

### 2.2.3 Advantages of optical communications systems with coherent detection

As mentioned previously the coherent optical communications systems have better performance than incoherent optical communications systems and may be used the phase, amplitude and frequency and state of polarization (SOP) of the optical signal allowing various digital modulation formats of both amplitude, phase and SOP combination. However, the coherent detection systems are expensive and complex (Kazovsky, 1996),

(Ryu, 1995) and require control mechanisms or subsystems of the state of polarization of the received signal with the optical signal generated by local oscillator (laser). Moreover, homodyne optical communications systems require coherent phase recovery of the optical carrier, and usually this is done through optical Phase Lock Loop (OPLL), Costas loop or other synchronization technique, which increases the complexity of these systems.

### 3. Optical and optoelectronic components

Devices such as the laser diodes, high-speed photo-receivers, optical amplifiers, optical modulators among others are derived of about thirty years of investigation and development of the fiber optics telecommunications systems. These technological advances has made possible the present OWC systems. Additionally, OWC systems have been benefited by the advances in the telescopes generated by the astronomy.

#### 3.1 Optical sources for transmitters

In modern optical wireless communications, there are a variety of light sources for use in the transmitter. One of the most used is the semiconductor laser which is also widely used in fiber optic systems. For indoor environment applications, where the safety is imperative, the Light Emitter Diode (LED) is preferred due to its limited optical power. Light emitting diodes are semiconductor structures that emit light. Because of its relatively low power emission, the LED's are typically used in applications over short distances and for low bit rate (up to 155Mbps). Depending on the material that they are constructed, the LED's can operate in different wavelength intervals. When compared to the narrow spectral width of a laser source, LEDs have a much larger spectral width (Full Width at Half Maximum or FWHM). In Table 1 are shown the semiconductor materials and its emission wavelength used in the LED's (Franz et al, 2000).

Material	Wavelength Range (nm)
AlGaAs	800 - 900
InGaAs	1000 - 1300
InGaAsP	900 - 1700

Table 1. Material, wavelength and energy band gap for typical LED

##### 3.1.1 Laser

The laser is an oscillator to optical frequencies which is composed by an optical resonant cavity and a gain mechanism to compensate the optical losses. Semiconductor lasers are of interest for the OWC industry, because of their relatively small size, high power and cost efficiency. Many of these lasers are used in optical fiber systems, there is no problem of availability. Table 2 summarize the materials commonly used in semiconductor lasers (Agrawal, 2005)

Material	Wavelength Range (nm)
GaAlAs	620 - 895
GaAs	904
InGaAsP	1100 - 1650 1550

Table 2. Materials used in semiconductor laser with wavelengths that are relevant for FSO

### 3.2 Photodetectors

At the receiver, the optical signals must be converted to the electrical domain for further processing, this conversion is made by the photo detectors. There are two main types of photodetectors, PIN diode (Positive-Intrinsic-Negative) and avalanche photodiode" avalanche photodiode (APD) (Franz et al, 2000). The main parameters that characterize the photodetectors in communications are: spectral response, photosensitivity, quantum efficiency, dark current, noise equivalent power, response time and bandwidth (Franz et al, 2000). The photodetection is achieved by the response of a photosensitive material to the incident light to produce free electrons. These electrons can be directed to form an electric current when applied an external potential.

#### 3.2.1 Pin photodiode

This type of photodiodes have an advantage in response time and operate with reverse bias. This type of diode has an intrinsic region between the PN materials, this union is known as homojunction. PIN diodes are widely used in telecommunications because of their fast response. Its responsivity, i.e. the ability to convert optical power to electrical current is function of the material and is different for each wavelength. This is defined as:

$$\mathfrak{R} = \frac{\eta e}{h\nu} \quad [\text{A/W}] \quad (3)$$

Where  $\eta$  is the quantum efficiency,  $e$  is the electron charge ( $1.6 \times 10^{-19}$  C),  $h$  is Planck's constant ( $6.62 \times 10^{-34}$  J) and  $\nu$  is the frequency corresponding to the photon wavelength. InGaAs PIN diodes show good response to wavelengths corresponding to the low attenuation window of optical fiber close to 1500nm. The atmosphere also has low attenuation into regions close to this wavelength.

#### 3.2.2 Avalanche photodiode

This type of device is ideal for detecting extremely low light level. This effect is reflected in the gain  $M$ :

$$M = \frac{I_G}{I_p} \quad (4)$$

$I_G$  is the value of the amplified output current due to avalanche effect and  $I_p$  is the current without amplification. The avalanche photo diode has a higher output current than PIN diode for a given value of optical input power, but the noise also increases by the same factor and additionally has a slower response than the PIN diode (see table 3).

Material and Structure	Wavelength (nm)	Responsivity (A/W)	Gain	Rise time
PIN. Silicon	300 - 1100	0.5	1	0.1-5 ns
PIN InGaAs	1000 - 1700	0.9	1	0.01-5 ns
APD Germanium	800 - 1300	0.6	10	0.3-1 ns
APD InGaAs	1000 - 1700	0.75	10	0.3 ns

Table 3. Characteristics of photo detectors used in OWC systems

Table 3 shows some of the materials and their physical properties used to manufacture of photo-detectors (Franz et al, 2000).



### 3.3 Optical amplifiers

Basically there are two types of optical amplifiers that can be used in wireless optical communication systems: semiconductor optical amplifier (SOA) and amplifier Erbium doped fiber (EDFA). Semiconductor optical amplifiers (SOA) have a structure similar to a semiconductor laser, but without the resonant cavity. The SOA can be designed for specific frequencies. Erbium-doped fiber amplifiers are widely used in fiber optics communications systems operating at wavelengths close to 1550 nm. Because they are built with optical fiber, provides easy connection to other sections of optical fiber, they are not sensitive to the polarization of the optical signal, and they are relatively stable under environment changes with a requirement of higher saturation power than the SOA.

### 3.4 Optical antennas

The optical antenna or telescope is one of the main components of optical wireless communication systems. In some systems may have a telescope to the transmitter and one for the receiver, but can be used one to perform both functions. The transmitted laser beam characteristics depend on the parameters and quality of the optics of the telescope. The various types of existing telescopes can be used for optical communications applications in free space. The optical gain of the antennas depends on the wavelength used and its diameter (see equations 5, 40 and 41). The Incoherent optical wireless communication systems typically expands the beam so that any change in alignment between the transmitter and receiver do not cause the beam passes out of the receiver aperture. The beam footprint on the receiver can be determined approximately by:

$$D_f \approx \theta L \quad (5)$$

$D_f$  is the footprint diameter on the receiver plane in meters,  $\theta$  is the divergence angle in radians and  $L$  is the separation distance between transmitter and receiver (meters). The above approximation is valid considering that the angle of divergence is the order of milliradians and the distances of the links are typically over 500 meters.

## 4. Factors affecting the terrestrial optical wireless communications systems

Several problems arise in optical wireless communications because of the wavelengths used in this type of system (Osche, 2002). The main processes affecting the propagation in the atmosphere of the optical signals are absorption, dispersion and refractive index variations (Collet, 1970), (Goodman, 1985) (Andrews, 2005), (Wheelon, 2003). The latter is known as atmospheric turbulence. The absorption due to water vapor in addition with scattering caused by small particles or droplets or water (fog) reduce the optical power of the information signal impinging on the receiver (Willebrand, 2002). Because of the above mentioned previously, this type of communications system is susceptible to the weather conditions prevailing in its operating environment. Figure 6 shows the disturbances affecting the optical signal propagation through the atmosphere.

### 4.1 Fog

Fog is the weather phenomenon that has the more destructive effect over OWC systems due to the size of the drops similar to the optical wavelengths used for communications links (Hemmati et al, 2004.). Dispersion is the dominant loss mechanism for the fog (Hemmati et al, 2004.). Taking into account to the effect over the visibility parameter the fog is classified

as low (1-5 km), moderate (0.2-1 km) and dense (0.034 – 0.2 km). The attenuation due to visibility can be calculated using the following equation (Kim et al, 2000):

$$P_v = \exp \left[ \frac{-3.9}{V} \left( \frac{\lambda}{0.55} \right)^m L \right] \quad (6)$$

Where  $V$  is the visibility [km],  $L$  is the propagation range and  $m$  is the size distribution for the water drops that form the fog.

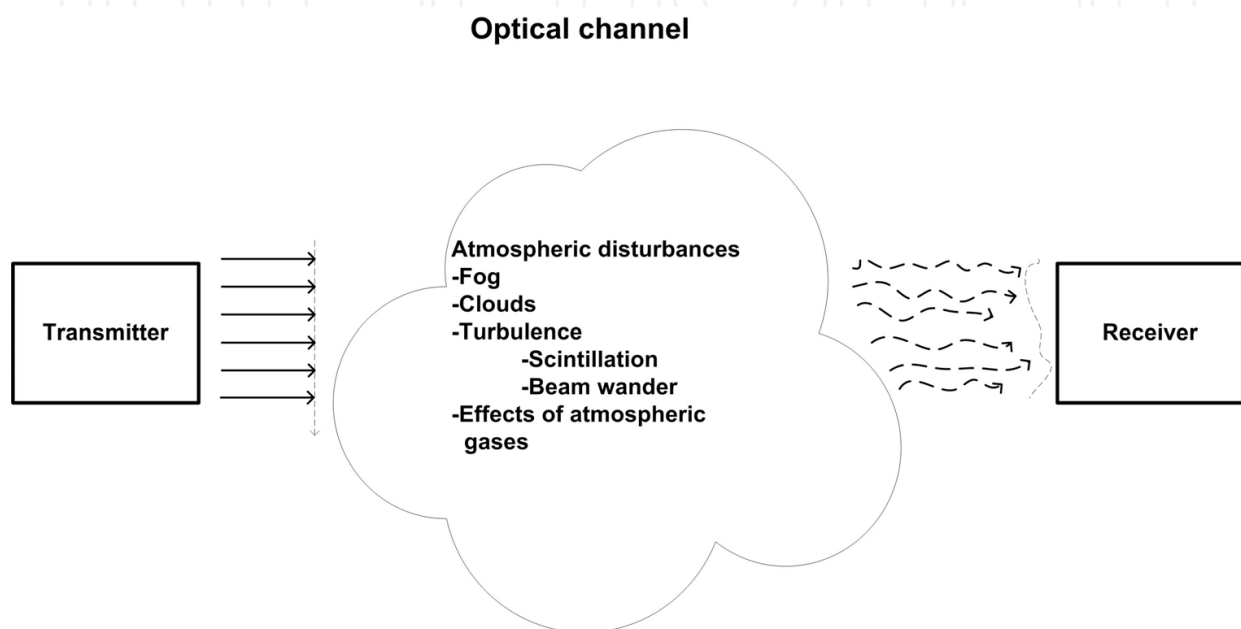

Fig. 6. Optical link over a terrestrial atmospheric channel

#### 4.2 Rain

Other weather phenomena affecting the propagation of an optical signal is the rain, however its impact is in general negligible compared with the fog due to the radius of the drops ( $200\mu\text{m}$  -  $2000\mu\text{m}$ ) which is significantly larger than the wavelength of the light source OWC systems [Willebrand 2002].

#### 4.3 Effects due to atmospheric gases. Dispersion and absorption

The dispersion is the re-routing or redistribution of light which significantly reduces the intensity arriving into the receiver (Willebrand, 2002). The absorption coefficient is a function of the absorption of each of the particles, and the particle density. There absorbent which can be divided into two general classes: molecular absorbent (gas) []; absorbing aerosol (dust, smoke, water droplets).

#### 4.4 Atmospheric windows

The FSO atmospheric windows commonly used are found in the infrared range.

The windows are in  $0.72\mu\text{m}$  and  $1.5\mu\text{m}$ , and other regions of the absorption spectrum. The region of  $0.7\mu\text{m}$  to  $2.0\mu\text{m}$  is dominated by the absorption of water vapor and the region of  $2.0\mu\text{m}$  to  $4.0\mu\text{m}$  is dominated by the combination of water and carbon dioxide.

#### 4.5 Aberrations losses

These losses are due to the aberrations of the optical elements and can be expressed as:

$$L_{ab} = e^{-(k\sigma_a)^2} \quad (7)$$

$$k=2\pi/\lambda$$

$\sigma_a$ =rms aberrations error

#### 4.6 Atmospheric attenuation

Describes the attenuation of the light traveling through the atmosphere due to absorption and dispersion. In general the transmission in the atmosphere is a function of link distance  $L$ , and is expressed in Beer's law as [Lambert et al, 1995]

$$L_{atm} = 10 \log \tau \left[ \frac{dB}{Km} \right] \quad (8)$$

with

$$\frac{I_d}{I_{Tx}} = \tau = \exp(-\gamma L) \quad (9)$$

$I_d/I_{Tx}$  is the relationship between the intensity detected and the transmitted output intensity and  $\gamma$  is the attenuation coefficient. The attenuation coefficient is the addition of four parameters; the dispersion coefficients of molecules and aerosols,  $\alpha$  and absorption coefficient,  $\beta$  of molecules and aerosols, each depending on the wavelength and is given by (Lambert et al 1995).

$$\gamma = \alpha_{molecule} + \alpha_{aerosol} + \beta_{molecule} + \beta_{aerosol} \quad (10)$$

#### 4.7 Atmospheric turbulence

Inhomogeneities in temperature and pressure variations of the atmosphere cause variations in the refractive index, which distort the optical signals that travel through the atmosphere. This effect is known as atmospheric turbulence. The performance of atmospheric optical communications systems will be affected because the atmosphere is a dynamic and imperfect media. Atmospheric turbulence effects include fluctuations in the amplitude and phase of the optical signal (Tatarski, 1970), (Wheelon, 2003). The turbulence-induced fading in optical wireless communication links is similar to fading due to multipaths experienced by radiofrequency communication links (Zsu, 2002). The refractive index variations can cause fluctuations in the intensity and phase of the received signal increasing the link error probability.

As mentioned briefly above, the heating of air masses near the earth's surface, which are mixed due to convection and wind generates atmospheric turbulence. These air masses have different temperatures and pressure values which in turn leads to different refractive index values, affecting the light traveling through them. The atmospheric turbulence has important effects on a light beam especially when the link distance is greater than 1 km (Zsu, 1986). Variations in temperature and pressure in turn cause variations in the refractive index along the link path (Tatarski, 1971) and such variations can cause fluctuations in the

amplitude and phase of the received signal (known as flicker or scintillation) (Gagliardi, 1988). Kolmogorov describe the turbulence by eddies, where the larger eddies are split into smaller eddies without loss of energy, dissipated due to viscosity (Wheeler, 2003, Andrews, 2005), as shown in Figure 7. The size of the eddies ranges from a few meters to a few millimeters, denoted as outer scale  $L_0$ , and inner scale,  $l_0$ , respectively as shown in Figure 7 and eddies or inhomogeneities with dimensions that are between these two limits are the range or inertial subrange (Tatarski, 1971).

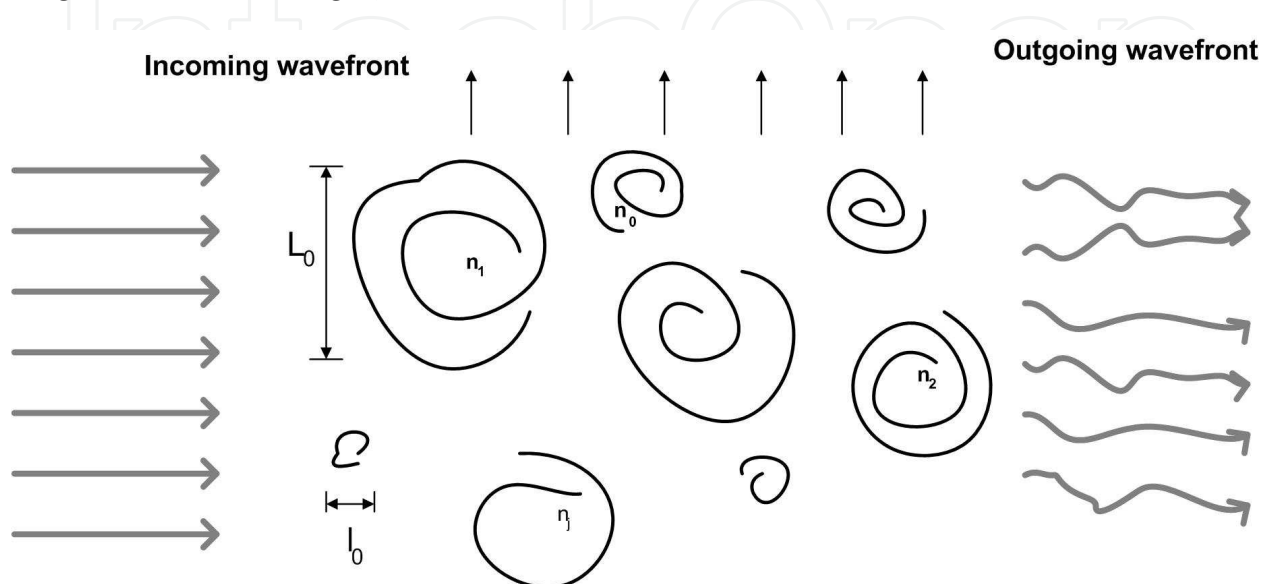

Fig. 7. Turbulence model based on eddies according to the Kolmogorov theory

A measure of the strength of turbulence is the constant of the structure function of the refractive index of air,  $C_n^2$ , which is related to temperature and atmospheric pressure by (Andrews, 2005):

$$C_n^2 = \left( 79 \times 10^{-6} \frac{P}{T} \right)^2 C_T^2 \quad (11)$$

Where  $P$  is the atmospheric pressure in millibars,  $T$  is the temperature in Kelvin degrees and  $C_T^2$  is the constant of the structure function. In short intervals, at a fixed propagation distance and a constant height above the ground can be assumed that  $C_n^2$  is almost constant, (Goodman, 1985). Values of  $C_n^2$  of  $10^{-17} \text{ m}^{-2/3}$  or less are considered weak turbulence and values up to  $10^{-13} \text{ m}^{-2/3}$  or more as strong turbulence (Goodman, 1985). We can also consider that in short time intervals, for paths at a fixed height,  $C_n^2$  is constant (the above for horizontal paths).  $C_n^2$  varies with height (Goodman, 1985).

Another measure of the turbulence is the Rytov variance, which relates the structure constant of refractive index with the beam path through the following equation:

$$\sigma_R^2 = 1.23 C_n^2 k^{7/6} L^{11/6} \quad (12)$$

where  $\lambda$  is the wavelength,  $L$  is the distance from the beam path and  $k=2\pi/\lambda$ .

An optical light beam is affected by turbulence in different ways: variations in both intensity and amplitude, phase changes (phase front), polarization fluctuations and changes on the angle of arrival.

#### 4.8 Intensity and amplitude fluctuations

The atmospheric turbulence affects the amplitude and phase of the optical signal that propagates through the medium in two points separated by a distance  $r$ , and can be described by the following equation according to the Rytov method for solving Maxwell's equations (Goodman, 1985):

$$U(\vec{r}) = U_0(\vec{r}) \exp(\psi(\vec{r})) \quad (13)$$

where  $U_0(r)$  is the undisturbed field. The complex phase perturbation can be written (Andrews, 2005):

$$\psi_1(\vec{r}) = \chi + iS_1 \quad (14)$$

or

$$\psi_1(\vec{r}) = \ln\left(\frac{A}{A_0}\right) + i(S - S_0) \quad (15)$$

where  $\chi$  is the logarithm of the amplitude  $A$  and  $S$  is the phase of the field  $U(r)$  and  $A_0$  and  $S_0$  are the amplitude and phase without disturbing respectively. This analysis is done based on the Rytov approximation and shows that the irradiance (or intensity) fluctuations follow a lognormal distribution due to that the logarithm of the amplitude and the irradiance are related by (Goodman, 1985):

$$\chi = \frac{\left[ \ln\left(\frac{I}{A^2}\right) \right]}{2} \quad (16)$$

According to the Rytov approximation, the variance of the logarithm of the amplitude  $\langle \chi^2 \rangle$  for a plane wave is (Goodman 1985):

$$\langle \chi^2 \rangle = \sigma_\chi^2 = 0.307 C_n^2 L^{11/6} k^{7/6} \quad (17)$$

It has been shown that the above equation (13) is a good approximation for values of  $\sigma_\chi^2 < 1$  (Wheelon, 2003]. The variance of the logarithm of the intensity is related to the variance of the logarithm of the amplitude of (Wheelon, 2002).

$$\sigma_{\ln I}^2 = \left\langle \left| \ln I - \langle \ln I \rangle \right|^2 \right\rangle = 4\sigma_\chi^2 \quad (18)$$

and

$$\sigma_{\ln I}^2 = 1.23 C_n^2 L^{11/6} k^{7/6} = \sigma_R^2 \quad (19)$$

Where  $\sigma_R^2$  is known as the Rytov variance. The Rytov variance for an infinite plane wave gives information about the strength of the fluctuations in the irradiance and hence gives us an idea of the strength of the atmospheric turbulence. Table II shows the relationship between values of Rytov variance and the strength of fluctuations (Wasiczko, 2004).

Strength levels of turbulence	Rytov variance
Weak	$\sigma_R^2 < 0.3$
Medium	$\sigma_R^2 \sim 1$
Strong	$\sigma_R^2 \gg 1$

Table 4. Typical values of turbulence for turbulence levels from weak to strong

Probability distribution function	Theory	Features	Application
Rician [Wheelon, 2001]	Born approximation	Little agreement with experimental data	Extremely weak turbulence regime
Lognormal [Tatarski, 1970]	Rytov approximation	Matching moments with experimental data	Weak turbulence regime
Negative Exponential [Andrews, 2005]	Heuristics	Easy to handle analytically	Saturation regime
I-K [Andrews, 2005]	Modulation effects of large scales to small scales	Difficult to relate PDF* parameters with the turbulence ones	Strong Turbulence
Lognormal - Rician [Andrews, 2005]	Modulation effects of large scales to small scales	Difficult to relate PDF* parameters with the turbulence ones	Strong Turbulence
Gamma-Gamma [Andrews, 2005]	Modulation effects of large scales to small scales	Its parameters are directly related to the turbulence.	Weak to strong turbulence

Table 5. Models for irradiance distributions (\*PDF: Probability distribution function)

Another parameter used to compare the magnitude of the fluctuations of the irradiance is the transverse coherence length of an electromagnetic wave at optical frequencies (Wheelon, 2001). The coherence length for a plane wave is obtained from (Wheelon, 2003).

$$\rho_0 = (1.46k^2LC_n^2)^{-3/5} \quad (20)$$

For a spherical wave coherence length is given by (Wheelon, 2003)

$$\rho_0 = (0.546k^2LC_n^2)^{-3/5} \quad (21)$$

The coherence radius  $\rho_0$  defined by Fried (Andrews, 2005) is:

$$r_0 = 2.099\rho_0 \quad (22)$$

The meaning of  $\rho_0$ , can be interpreted as follows: the phase in the wave front does not experience fluctuations in the sense of mean square root of greater than one radian at a distance  $\rho_0$  wavefront at the receiver (Wheelon, 2003). The following table summarizes and

compares different models for irradiance distribution that have been proposed by several authors (Andrews, 2005), (Zsu, 2002).

#### 4.9 Phase variations

The phase fluctuations are not usually taken into account in incoherent optical wireless communication systems. However, in coherent optical wireless communication systems they should be considered. The phase fluctuations are caused by large eddies including those of outer scale (Goodman, 1985). It follows that the analysis of phase fluctuations are based on geometrical optics. Diffraction effects due to small-scale inhomogeneities have little effect on the result obtained based on geometrical optics (Wheelon, 2001). The complex phase disturbance [equation (40)], the phase  $S(\vec{r}, L)$  can be expressed (Tatarski, 1971) as:

$$S(\vec{r}, L) = \frac{1}{2i} [\psi(\vec{r}, L) - \psi^*(\vec{r}, L)] \quad (23)$$

considering that the turbulence in the atmosphere is homogeneous and isotropic, the phase variance (Andrews, 2005) is:

$$\sigma_s^2 \cong 4\pi^2 k^2 L \int_0^\infty \kappa \Phi_n(\kappa) d\kappa \quad (24)$$

the phase covariance function or the spatial covariance function for plane wave can be expressed as:

$$B_{s,pl}(\rho, L) = 0.78 C_n^2 k^2 \left( \frac{\rho}{\kappa_0} \right)^{-5/6} K_{5/6}(\kappa_0 \rho) \quad (25)$$

where  $K$  is the modified Bessel function of second class. The temporal covariance function can be obtained from the spatial function using the frozen turbulence hypothesis of Taylor (Zhu and Kahn, 2002) replacing  $\rho = V_\perp \tau$  where  $V_\perp$  is the average wind speed transverse to the propagation path. Therefore, the spatial covariance function is (Wheelon, 2003).

$$B_{s,pl}(\tau, L) = 0.78 C_n^2 k^2 \kappa_0^{-5/3} (\kappa_0 V_\perp \tau)^{5/6} K_{5/6}(\kappa_0 V_\perp \tau) \quad (26)$$

The power spectrum of phase variations was first published in the work of (Clifford, 1970) and can be obtained using the Wiener Khintchine theorem (Tatarski, 1970) as shown below. Applying the Fourier transform of the function of temporal phase covariance, we obtain the temporal spectrum of phase variations [Tatarski, 1970].

$$\begin{aligned} S_{s,pl}(\omega) &= 4 \int_0^\infty B_{s,pl}(\tau, L) \cos(\omega \tau) d\tau \\ &= 3.13 C_n^2 k^2 L \kappa_0^{-5/3} \int_0^\infty (\kappa_0 V_\perp \tau)^{5/6} K_{5/6}(\kappa_0 V_\perp \tau) \cos(\omega \tau) d\tau \end{aligned} \quad (27)$$

Evaluating the integral gives [Wheelon, 2003] we obtain the approximated expression

$$S_{s,pl}(\omega) = \frac{5.82 C_n^2 L V_\perp^{5/3}}{(\omega^2 + \kappa_0^2 V_\perp^2)^{4/3}} \quad (28)$$

#### 4.10 Polarization fluctuations

The electromagnetic field is characterized by an electric field and a magnetic field which are vector quantities. The direction taken by the electric field vector at each point along the path is defined by the polarization of the field (Fowles, 1968). There have been several studies to estimate the magnitude of the change of polarization in an optical frequency electromagnetic signal as it travels through the turbulent atmosphere (Collet, 1972) (Strohbehn, & Clifford, S. 1967). These studies conclude that the change in the state of polarization of a beam traveling in a line of sight path in the turbulent atmosphere is negligible. Depolarization is usually measured as the ratio between the average intensity of the orthogonal field component and the incident plane wave (Wheelon, 2003). Under certain considerations depolarization can be obtained through:

$$\delta\text{Pol} = 0.070C_n^2(\kappa_0)^{7/3}k^{-2} \quad (29)$$

Various expressions have been obtained to determine the depolarization of an electromagnetic field at optical frequencies, considering quasi-monochromatic light sources and the results are similar. For example for  $L = 1500\text{m}$ ,  $\lambda = 1550\text{ nm}$  and  $C_n^2 = 1 \times 10^{-13}$  the depolarized component is  $2.1 \times 10^{-18}$  smaller in terms of the polarized component (Wheelon, 2001).

#### 4.11 Arrival angle fluctuations

Fluctuations on the angle of arrival is another effect of atmospheric turbulence and seriously affects the performance of the communications system (Andrews, 2005). The movement of the centroid of the spot intensity on the receiver due to local inhomogeneities in the transmitter are responsible for this phenomenon. In the case of non-coherent optical wireless communications systems, this effect can be decreased by expanding the transmitted beam, so you always get intensity above the detection threshold to the receiver at the expense of the decrease in the average intensity (Wheelon, 2003). A more sophisticated technique is the use of pointing and tracking mechanisms of the centroid of the optical signal which makes adjustments on both the receiver and transmitter to ensure the highest possible alignment between them (Hemmati, 2006). Another way of reducing the effects of the variations on the angle of arrival is the use of adaptive optics, which correct these variations provided that the receiver aperture is large enough (Wheelon, 2001), (Andrews, 2005). The variance of the perturbations of the angle of arrival are obtained from the following equation (Wheelon, 2003).

$$\langle \delta\theta^2 \rangle = 2\pi R \int_0^\infty d\kappa \kappa^2 \Phi(\kappa) \quad (30)$$

#### 4.12 Statistical models of wireless optical channel

As mentioned above, various probability distribution functions have been proposed to describe the statistical behavior of atmospheric optical communications channel. It was found that the amplitude distribution (or intensity) and phase is dependent on the theory of propagation of optical beams used. The phase distribution is obtained from geometrical optics and found that is suitable for the various regimes of turbulence (Andrews, 2005). Under the condition that the beam path is much larger than the size of the outer scale, based on the application of central limit theorem phase fluctuations of the optical signal is Gaussian and several experiments have supported the outcome (Clifford, 1970).



### 4.13 System design

This section will show the basics for the design of a OWC link. The power budget of an optical link must consider different impairments that affect the system performance such as : a) finite transmission power, b) optical gains and losses, c) Receiver sensitivity, d) propagation losses, e) electronics noise, f) phase noise of optical sources g) imperfect synchronization for coherent detection optical carrier, among others. First, we determine the fade margin between the transmitted optical power and minimum receiver sensitivity needed to establish a specified BER. It also should be considered the system margin ( $M_s$ ), to compensate for the degradation of components and temperature factors. It is required to estimate a margin of availability ( $M$ ) or link power budget, which is given by the following equation.

$$M = L_f - L_{\text{tur}} - L_{\text{prop}} - L_{\text{poin}} - L_{\text{atm}} - M_s \quad (31)$$

where:

$L_f$  : fade margin

$L_{\text{tur}}$  : turbulence losses

$L_{\text{prop}}$  : propagation losses

$L_{\text{poin}}$  : Pointing losses

$L_{\text{atm}}$  : atmospheric losses

$M_s$  : system margin

Parameters to be considered in the design are: wavelength, transmission rate, signal to noise ratio (SNR), link distance, diameter of the optical transmitter and receiver antennas, transmitter power and receiver sensitivity. We describe below the relationship among the parameters mentioned.

#### 4.13.1 Fade margin

It is defined as the amount of the total losses allowed by the system to perform the optical link and is obtained from the equation:

$$L_f = P_{\text{Tx}} - P_{\text{sens}} \quad (32)$$

#### 4.13.2 Propagation losses

Propagation losses are given by (Santamaria A., Lopez-Hernandez F.J., 1994):

$$L_{\text{prop}} = 10 \log_{10} \left( \frac{4\pi Z}{\lambda} \right)^2 \quad (33)$$

where  $Z$  is the distance between the transmitter and receiver.

#### 4.13.3 Turbulence losses

These losses take into account the effects of the variation of intensity of the laser beam due to atmospheric turbulence (scintillation) and can be estimated through:

$$L_{\text{turb}} = 10 \log_{10} \left[ 1 + \left( \frac{\Omega_0}{\Omega_{\text{turb}}} \right)^2 \right] \quad (34)$$

where

$$\Omega_0 = \frac{2\lambda}{\pi D_{\text{Lens\_Tx}}} \quad (35)$$

With  $D_{\text{Lens\_Tx}}$  is the lens transmitter diameter, and

$$\Omega_{\text{turb}} = \frac{\lambda}{\pi \rho_o} \quad (36)$$

where  $\rho_o$  is the coherence radius.

#### 4.13.4 Pointing losses

Pointing losses are due to misalignment between the transmitter and receiver the which causes reduction in the power captured by the receiver (A. Santamaria, FJ Lopez-Hernandez, 1994), are given by (A. Santamaria, FJ Lopez-Hernandez, 1994)

$$L_{\text{pointing}} = 4.3229 \left( \frac{\phi_e}{\Omega_0} \right)^2 \quad (37)$$

Where  $\phi_e$  is the boundary angle of diffraction-limited beam of the transmitter and is given by

$$\phi_e \cong \frac{\lambda}{2D_{\text{Lens\_Tx}}} \quad (38)$$

#### 4.13.5 Atmospheric losses

They appears when the particle causing the scattering has the diameter equal to or greater than the wavelength of the radiation signal. These losses are due to atmospheric gases (Beer's law). The attenuation and scattering coefficients are related with the visibility (Kim et al).

#### 4.13.6 Geometric losses

Geometric path losses for a FSO link depends on the beamwidth of the optical transmitter ( $\theta$ ), the path length (L) and the receiver aperture area ( $D_r$ ) (Figure 8):

$$L_{\text{geo}} = 20 \log \left( \frac{\theta L}{D_r} \right) \quad \text{dB} \quad (39)$$

L=transmitter-receiver distance

$\theta$ =Beam Divergence

$D_r$ =Receiver diameter

#### 4.13.7 Transmitting and receiving antenna gain

The gain of the transmitting antenna for free space is given by (A. Santamaria, FJ Lopez-Hernandez, 1994)

$$G_{Tx} = 10 \log_{10} \left( \frac{2}{\Omega_0} \right)^2 \quad (40)$$

The receiving antenna gain is given by (A. Santamaria, FJ Lopez-Hernandez, 1994)

$$G_{Rx} = 10 \log_{10} \left( \frac{4\pi A_r}{\lambda^2} \right) \quad (41)$$

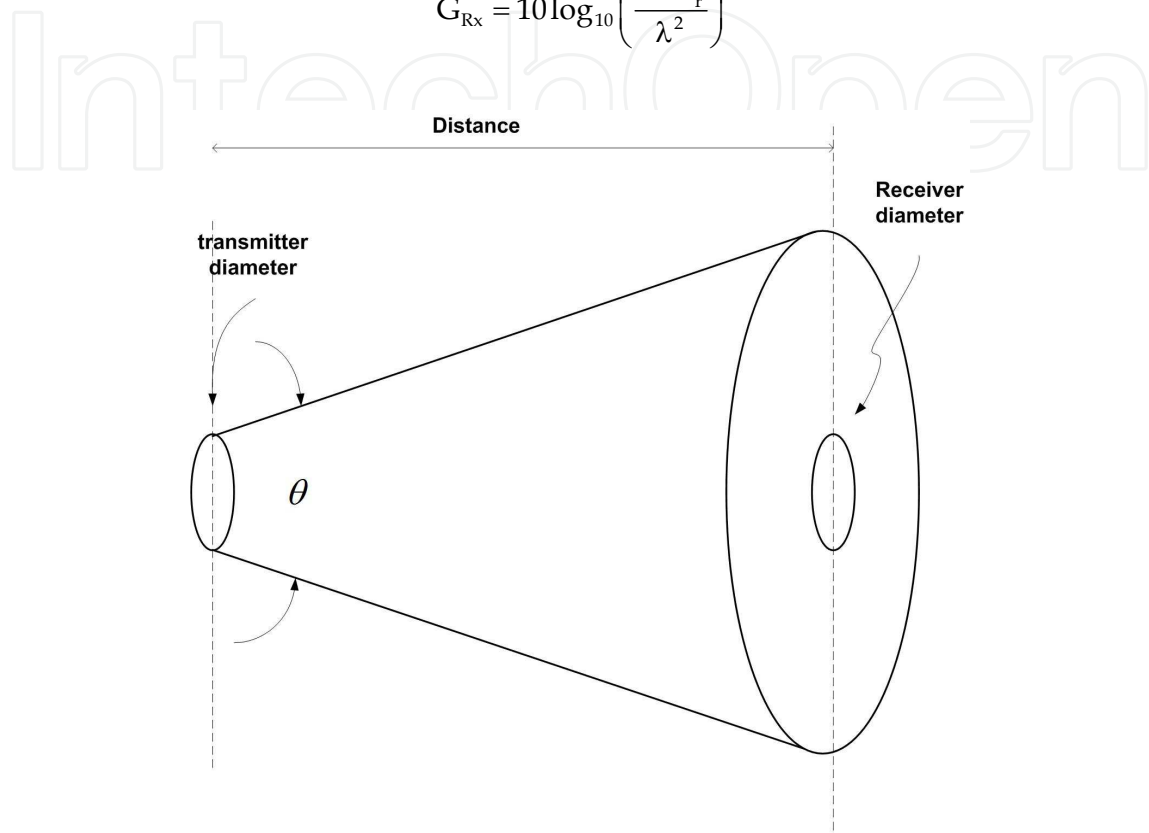

Fig. 8. Geometric losses scheme

## 5. Mitigating the effects of turbulent optical channel

One of the problems to be resolved in optical communication systems is to reduce the effects of turbulence, i.e. the scintillation and variations of the angle of arrival of the beam. Various techniques are used to reduce these phenomena. Among them we can mention the use of encryption, the use of large aperture receivers, using alignment systems, spatial diversity and amplifiers using erbium-doped fiber (EDFA).

### 5.1 Using coding to reduce the effects of turbulence in OWC systems

One way to improve the performance of wireless optical communication systems is the use of channel coding techniques. Several studies have been conducted to study the effect of the use of channel coding techniques in conditions of strong turbulence (Tisftsis, 2008) which is the scenario that offers the worst operating conditions. Pulse modulations such as PPM (Pulse Position Modulation) have been analyzed under the effects of weak turbulence (Hemmati, 2006). These results indicate the need for error correction in the receiver (FEC) to make communication possible under these conditions (Ohtsuki, 2003).

### **5.2 Large aperture receiver**

It is known that for incoherent optical communications systems, such as IM-DD systems, the use of larger receiver apertures, increase the optical power collected leading to a reduction in scintillation. This effect is known as aperture averaging. This means that the larger the diameter of the receiving aperture, the power collected is higher, the signal has a better signal to scintillation noise ratio and the photo-current fluctuations are reduced (Fried, 1967).

### **5.3 Tracking and pointing systems**

To reduce the effects of drift in the beam and the transmitter-receiver misalignment, phenomena that reduce the performance of wireless optical communication systems, mechanical systems can be used to correct both transmitter and receiver to compensate for variations tilt and pitch. This is possible because both changes occur at speeds of tenths of seconds (corresponding to frequencies below 100 Hz) (Andrews, 2005).

### **5.4 Use of spatial diversity to mitigate the effects of turbulence**

One way to reduce the effect of signal fading due to turbulence, which is mainly caused by beam wander, is the use of arrangements of receivers (Andrews, 2005).

### **5.5 Erbium-doped fiber amplifiers (EDFA)**

The use of EDFA in the receiver avoids the use of high power transmission. It has been shown that the use of these devices also reduces the scintillation due to increased average received optical power (Franz & Jain, 2000), but these devices could be expensive for certain applications of OWC systems.

## **6. Methods of modulation and coding**

Traditionally, wireless communications systems use optical modulation formats OOK (On-Off Keying), which is also widely used in fiber optic systems and is characterized by its simplicity and robustness. This system consists of intensity modulated optical carrier and digital information is sent with the presence or absences of the optical carrier. Other modulation techniques have been used in optical wireless communication systems, such as pulse position modulation and the use of phase-modulated subcarriers. One of the problems present in the transmission of optical signals is scintillation, which reduces the optical power available at the receiver for periods that can be several milliseconds to values below the detection threshold and thus interruption link. Different alternatives for the solution to this problem have been proposed and analyzed. You can increase the received optical power using erbium-doped fiber amplifier (EDFA). The atmospheric turbulence reduces the received optical power which is caused by the low frequency components of the scintillation and is expressed as the displacement of the centroid of the spot or footprint of the beam in the plane of the receiver (beam wander).

### **6.1 Incoherent optical communication systems. OOK modulation**

Within the methods of direct detection and intensity modulation, one of the most used techniques is the On-Off Keying modulation. For this modulation has been found that the probability of error (Andrews, 2005) is:

$$P_e = \frac{1}{2} \int_0^{\infty} f_I(i) \operatorname{erfc} \left( \frac{\operatorname{SNR}(i)}{2\sqrt{2}} \right) di \quad (42)$$

where SNR is the signal to noise ratio as a function of intensity and  $\operatorname{erfc}$  is the complementary error function.  $f_I(\cdot)$  is the probability density function of changes in signal strength.

### 6.2 Use of subcarriers

Basically, the resurgence of practical OWC systems is due to the technological developments of the systems of fiber optic communications. One of the techniques used to improve the performance of OWC systems is the use of sub-carriers. In this method, the laser beam intensity is modulated by an electrical signal derived from a combination of these subcarriers. Figure 9 shows the block diagram for subcarrier intensity modulations systems.

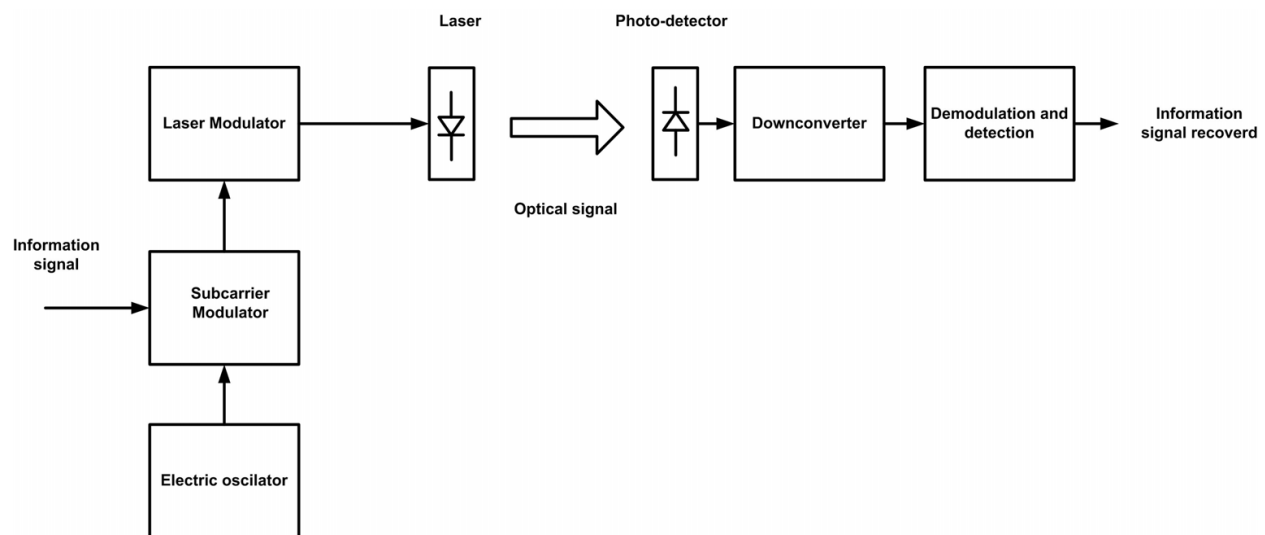

Fig. 9. Subcarrier intensity modulation OWC

### 6.3 Coherent optical communication systems

As indicated above, the current optical communications systems are based on incoherent modulation techniques which are relatively simple to implement and robust, but its theoretical performance is below the coherent modulation format. This type of system has advantages in relation to sensitivity, frequency selectivity and increased lodging capacity of channels in the bandwidth of the optical carrier. The coherent optical communication systems in atmospheric space applications have interesting characteristics that make them attractive for potential commercial use. For example, the homodyne detection of binary phase modulated signals (BPSK), the quantum limited is obtained with only 9 photons per bit, when in the OOK systems are needed 38 photons per bit. The BER for BPSK modulation is an average over the all possible intensity levels of a given probability density function,  $p_I(I)$  without regard phase noise (Sánchez, 2008):

$$\operatorname{BER} = \int_0^{\infty} p_I(\xi) \operatorname{erfc} \left( \sqrt{\operatorname{SNR}(\xi)} \right) d\xi \quad (43)$$

The optical phase synchronization, and control of the state of polarization are the main challenges for the practical implementation of coherent systems using optical fiber as transmission medium (Kazovsky, 2006).

In the case of wireless systems, in clear sky conditions, the state of polarization suffers little variation and these changes are slow (Hodara, 1966) (Wheelon, 2001), but it is required that the state of polarization of the signal optical input matches the local oscillator. Carrier synchronization is necessary to achieve the demodulation in coherent systems. The phase modulation techniques are usually suppressed carrier. Techniques such as injection locking, optical phase lock loop (OPLL) can not be used directly to lock the local oscillator phase [Kazovsky, 1986]. With the advent of high-speed digital components, the compensation of polarization, as well as other phenomena of the optical channel can be obtained in the electrical domain, opening up new possibilities for the practical implementation of optical communication systems consistent (Sánchez, 2008), (Arvizu, 2010). Figure 10 shows the block diagram of a coherent optical wireless communication system which shows the possible subsystems required to enable proper operation. At the transmitter, the optical phase modulation is performed while at the receiver is used an phase lock loop (PLL) to maintain synchronized the optical carrier signal with the optical local oscillator [Kazovski et al, 1995], and a state of polarization control system (Sánchez 2008), (Arvizu, 2010), as well as a balanced photo-reception stage.

Due to the loss of spatial coherence can not use aperture averaging in coherent optical communications systems and diameter in the aperture receiver must be smaller than the coherence distance  $r_0$  (equation 22). For example, with  $L=1500$  m,  $\lambda=1.550\mu\text{m}$  and  $C_n^2 = 7 \times 10^{-13}$ ,  $r_0=2.5$  cm (Figure 11).

However, the small apertures require the use of less divergence beams so that more optical power is collected by the receiver, which involves the use of pointing and tracking systems more fine and precise, making the system more complex and expensive. Another solution is the use of spatial diversity system. The space diversity coherent systems require that each unit receiving signals are processed individually before combining it and then perform the symbol detection process (Arvizu et al, 2010). That is, it requires that the signals to be synchronized in phase due to the loss of spatial coherence so that the combination of signals is not destructive and attenuates the signal received. This process can be performed optically or electronically (Arvizu et al, 2010). The distance between these coherent diversity receivers must be greater than  $r_0$ , so that the signals collected by each unit are uncorrelated.

Other proposed systems is the use of OWC systems with spatial diversity and coherent detection using (linear post detection combiner) (PDLC), which uses "n" receivers and develops individually detection by estimating the symbol for each (hypothesis "1" and "0") then becomes the weighting of the signal with better signal to noise ratio which is selected to obtain the output data (Arvizu et al, 2010).

Coherent optical communications systems offer several advantage in deep space applications, such as high sensivity, which is important because of the small signals existent in this scenery and the absence of atmospheric turbulence. Additionally coherent receivers have an inherent frequencial selectivity, as well as rejection of the background radiation, characteristics important in deep space applications.

Next generations of optical wireless communications could use differents strategies for reduce the turbulence effects. Adaptive optics is a technology utilized for improve the performance of astronomical telescopes by reducing the wavefront distortions and can be

used in OWC systems. However, still is a technology expensive for terrestrial OWC applications.

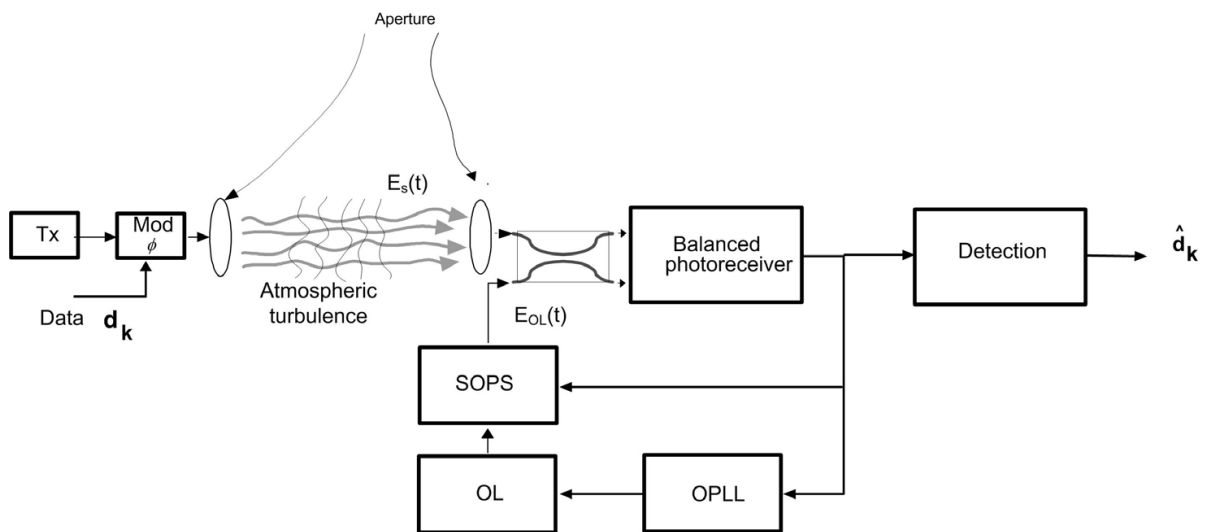

Fig. 10. Block diagram of the Coherent optical wireless communications system. SOPS: State of polarization system; OL: Local Oscillator; OPLL: Optical Phase lock loop

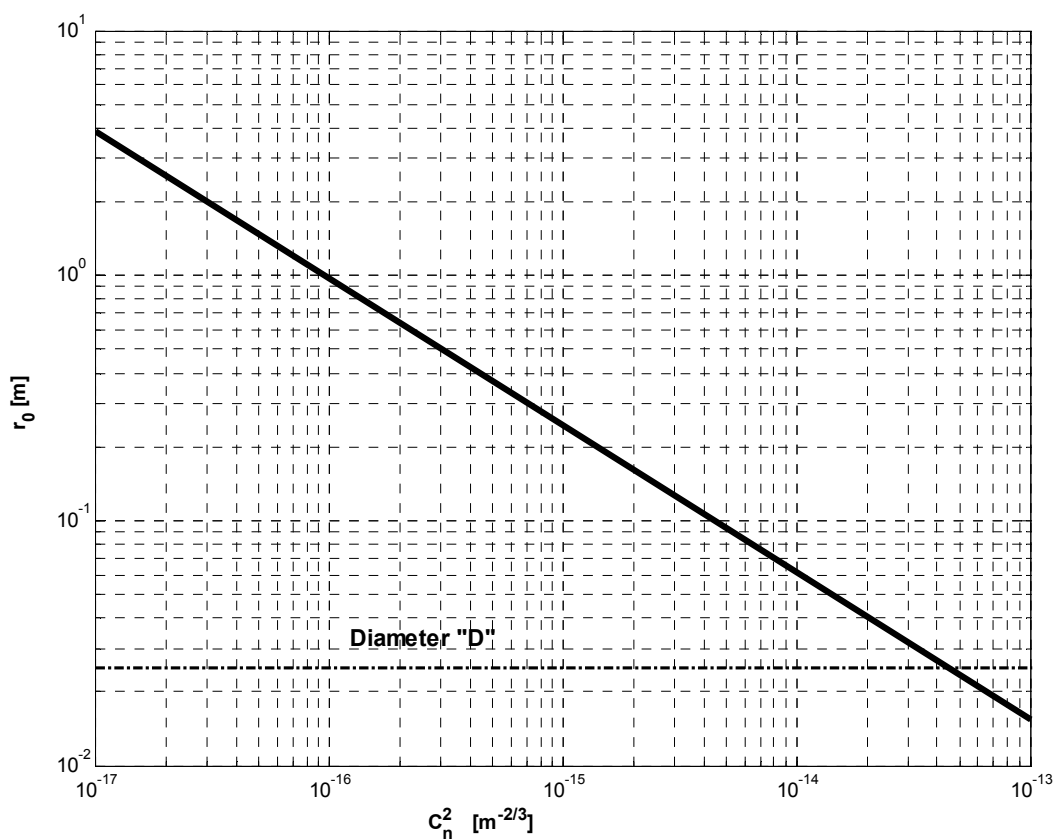

Fig. 11. Coherence diameter as function of the refractive index structure constant

## 7. Conclusions

In this chapter, the wireless optical communication systems have been discussed from first principles to systems that use different techniques to improve their performance. Different atmospheric channel characteristics have been emphasized and in general have shown the most relevant such as scintillation, the variations of the angle of arrival, the attenuation due to atmospheric gases and the effects of weather conditions. We analyzed the performance of communications systems for detecting incoherent modulations (OOK) and coherent (BPSK). This technology is becoming commonly used in civil applications and in the future be developed to have a scope similar to fiber optic systems in scope and availability.

## 8. References

- Agrawal, P, Govind (2005). *Light Wave Telecommunications Systems* John Wiley and Sons, Inc, ISBN -13 978-0-471-21572-2, New York.
- Andrews, L. C. & Phillips, R.L. (2005). *Laser beam propagation through random Media*. SPIE Press, ISBN 0-8194-5948-8 Bellingham, Washington.
- Arvizu M. Mondragón, Sánchez L. Juan de Dios, Mendieta J. Francisco Javier, Coherent Optical Wireless Link Employing Phase Estimation with Multiple Beam, Multiple Aperture, for Increased Tolerance to Turbulence, *IEICE Transactions communications*, Vol. E93-B, No. 1, (January 2010), 226-229, ISSN 1745-1345.
- Collet, E. & Alferness, R. (1972). Depolarization of a laser beam in a turbulent medium. *Journal of the Optical Society of America*. Vol. 62, No. 4, (529-533), ISSN 0030-3941.
- Clifford, S.F. (1970). Phase Variations in Atmospheric Optical Propagation, *Journal of the Optical Society of America*. Vol. 61, No. 10, (529-533), ISSN 0030-3941.
- Fowles G. R. 1975. *Introduction to modern optics*. Dover Publications. 2 edition, ISBN 0486659577, New York.
- Franz, J. H. & Jain, V.K. (2000). *Optical communications, components and systems*. CRC Press. ISBN 0-8493-0935-2, New Delhi.
- Fried, D.L. 1967. Optical heterodyne detection of an atmospherically distorted signal wave front. *Proceedings of IEEE*. Vol. 55, No. 1 (47-67).
- Gagliardi, Robert M. and Karp, Sherman (1995). *Optical Communications*, John Wiley and Sons, Inc., Second Edition, ISBN 978-0471542872, New York.
- Goodman, J. W. (1985). *Statistical Optics*. Wiley and Sons. ISBN 0471015024, New York.
- Hemmati, H. (2006). *Deep Space Optical Communications*, John Wiley and Sons, Inc., ISBN 978-0-04002-7.
- Kazovsky, L., Benedetto, S., Willner, A (1996). *Light Wave Telecommunications Systems*. Artech House, Inc. Norwood, ISBN 0-89006-756-2.
- Kedar, D. y Arnorn, S. (2003). Optical wireless communications through fog in the presence of pointing errors. *Applied Optics*. Vol. 42 No.24, (4946-4954) ISSN 2155-3165.
- Kim, I.I, Mc Arthur, B., Korevaar, E. (2000), Comparison of Laser Beam Propagation at 785 nm and 1550 nm, in Fog and Haze for Optical Wireless Communications. *Proceedings of SPIE Optical Wireless Communications III*, Vol. 4214, (26-37)
- Lambert, G. Stephen and Casey, L. William. (1995). *Laser Communication in Space*. Artech House, inc., Norwood. ISBN 0-89006-722-8.
- Ohtsuki, T. (2003). Performance analysis of atmospheric optical PPM CDMA systems. *Journal of Lightwave Technology*. Vol. 21 No. 2 (406-411), ISSN: 0733-8724.



- Osche, G. 2002. *Optical detection theory for laser applications*. John Wiley and Sons, ISBN 0-471-22411-1, New Jersey.
- Qingchong L., Chunming Q., Mitchell G., & Stanton S. (2005). Optical wireless communications networks for first-and last-mile broadband access. *Journal of Optical Networking*. Vol. 4 No. 12 (807-828), ISSN 1536-5379.
- Santamaria A., López-Hernández F.J. (1994). *Wireless LAN systems*, Artech House, ISBN 9780890066096.
- Sánchez L. Juan de Dios, Arvizu M., Arturo, Mendieta J., Francisco (2008). Optical Phase Estimation in an Urban Wireless Communications, *IEICE Transactions communications*, Vol. E91-B, No. 7, (July 2008), 2447-2450, ISSN 1745-1345.
- Strohbehn, J.W., y Clifford, S. (1967). Polarization and angle-of-arrival fluctuations for a plane wave propagated through a turbulent medium. *IEEE Transactions on Antennas and Propagation*, Vol. 15, No. 3 (416-421), ISSN 0018-926X.
- Tatarski, V.I. (1971). *The effects of turbulence atmosphere on wave propagation*. The National Oceanic and Atmospheric Administration. U.S. Department of Commerce, ISBN 07065-0680-4, Springfield, VA.
- Tisftsis T.A. 2008. Performance of heterodyne wireless optical communications systems over gamma atmospheric channels. *Electronics letters*. Vol. 44, No. 5, (373-375), ISSN: 0013-5194
- Wasiczko, L.M. (2006) *Techniques to mitigate the effects of atmospheric turbulence on free space optical communications link*. Ph.D Thesis. University of Maryland. 135 pp.
- Willebrand, H. Ghuman, B.S. (2000). *Free-space optics: enabling optical connectivity in today's networks*, Sams Publishing, Indiana, ISBN 0-672-32248-x, USA.
- Wheelon, A. D. (2001). *Electromagnetic scintillation Vol, I. Geometrical optics*. Cambridge University Press. Cambridge, ISBN 0521-801982
- Wheelon, A.D. (2003). *Electromagnetic scintillation Vol, II. Weak Scattering*. Cambridge University Press. Cambridge, ISBN: 0521801990.
- Zhu, X., Kahn J. M. (2002) Free Space Optical Communications Through Atmospheric Turbulence Channels, *IEEE Transactions on Communications*, Vol. 50, No. 8, August 2002. ISSN 0090-6778.

IntechOpen

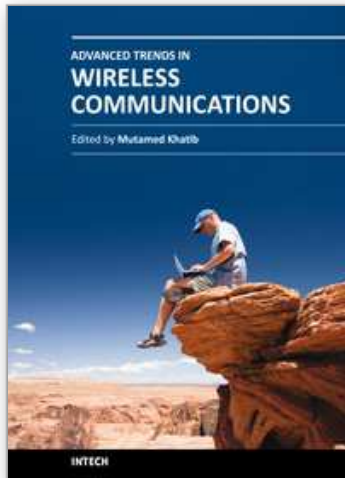

## **Advanced Trends in Wireless Communications**

Edited by Dr. Mutamed Khatib

ISBN 978-953-307-183-1

Hard cover, 520 pages

**Publisher** InTech

**Published online** 17, February, 2011

**Published in print edition** February, 2011

Physical limitations on wireless communication channels impose huge challenges to reliable communication. Bandwidth limitations, propagation loss, noise and interference make the wireless channel a narrow pipe that does not readily accommodate rapid flow of data. Thus, researches aim to design systems that are suitable to operate in such channels, in order to have high performance quality of service. Also, the mobility of the communication systems requires further investigations to reduce the complexity and the power consumption of the receiver. This book aims to provide highlights of the current research in the field of wireless communications. The subjects discussed are very valuable to communication researchers rather than researchers in the wireless related areas. The book chapters cover a wide range of wireless communication topics.

### **How to reference**

In order to correctly reference this scholarly work, feel free to copy and paste the following:

Juan-de-Dios Sánchez- López, Arturo Arvizu M, Francisco J. Mendieta and Iván Nieto Hipólito (2011). Trends of the Optical Wireless Communications, Advanced Trends in Wireless Communications, Dr. Mutamed Khatib (Ed.), ISBN: 978-953-307-183-1, InTech, Available from: <http://www.intechopen.com/books/advanced-trends-in-wireless-communications/trends-of-the-optical-wireless-communications>

**INTECH**  
open science | open minds

### **InTech Europe**

University Campus STeP Ri  
Slavka Krautzeka 83/A  
51000 Rijeka, Croatia  
Phone: +385 (51) 770 447  
Fax: +385 (51) 686 166  
[www.intechopen.com](http://www.intechopen.com)

### **InTech China**

Unit 405, Office Block, Hotel Equatorial Shanghai  
No.65, Yan An Road (West), Shanghai, 200040, China  
中国上海市延安西路65号上海国际贵都大饭店办公楼405单元  
Phone: +86-21-62489820  
Fax: +86-21-62489821

© 2011 The Author(s). Licensee IntechOpen. This chapter is distributed under the terms of the [Creative Commons Attribution-NonCommercial-ShareAlike-3.0 License](#), which permits use, distribution and reproduction for non-commercial purposes, provided the original is properly cited and derivative works building on this content are distributed under the same license.

IntechOpen

IntechOpen