

We are IntechOpen, the world's leading publisher of Open Access books Built by scientists, for scientists

4,800

Open access books available

122,000

International authors and editors

135M

Downloads

Our authors are among the

154

Countries delivered to

TOP 1%

most cited scientists

12.2%

Contributors from top 500 universities



WEB OF SCIENCE™

Selection of our books indexed in the Book Citation Index
in Web of Science™ Core Collection (BKCI)

Interested in publishing with us?
Contact book.department@intechopen.com

Numbers displayed above are based on latest data collected.

For more information visit www.intechopen.com



Wave Propagation in Dielectric Medium Thin Film Medium

E. I. Ugwu, Senior Lecturer
*Department of Industrial Physics, Ebonyi State University, Abakaliki,
Nigeria*

1. Introduction

Various tools have been employed in studying and computing beam or field propagation in a medium with variation of small refractive index Feit and (Fleck, et al, 1976)(Fleck, 1978)(Ugwu et al, 2007) some researchers had employed beam propagation method based on diagonalization of the Hermitian operator that generates the solution of the Helmholtz equation in media with real refractive indices (Thylen and Lee, 1992), while some had used 2x2 propagation matrix formalism for finding the obliquely propagated electromagnetic fields in layered inhomogeneous un-axial structure (Ong, 1993)

Recently, we have looked at the propagation of electromagnetic field through a conducting surface (Ugwu, 2005) and we observed the behaviour of such a material. The effect of variation of refractive index of FeS_2 had also been carried out (Ugwu, 2005)

The parameters of the film that were paramount in this work are dielectric constants and the thickness of the thin film.

The dielectric constants were obtained from a computation using pseudo-dielectric function in conjunction with experimentally measured extinction co-efficient and the refractive indices of the film and the thickness of the film which was assumed to range from $0.1\mu m$ to $0.7\mu m$ [100nm to 700nm] based on the experimentally measured value, at the wavelength, $450\mu m$ (Cox, 1978)(Lee and Brook, 1978)

This work is based on a method that involves propagating an input field over a small distance through the thin film medium and then iterating the computation over and over through the propagation distance using Lippmann-Schwinger equation and its counterpart, Dyson's equation (Economou, 1979) here, we first derived Lippmann-Schwinger equation using a specific Hamiltonian from where the field function $\psi_k(z)$ was obtained. From this, it was observed that to ease out the solution of the Lippmann-Schwinger equation, it was discretized. After this, Born approximation was applied in order to obtain the solution. The formalism is logically built up step-by-step, which allowed point-to-point observation of the behaviour of the field propagating through the film in order to analyze the influence of the field behavior as it propagates through small thin film thickness with consideration given to solid state properties such as dielectric function/refractive index, determine the absorption characteristics within the wavelength regions of electromagnetic wave spectrum and then to have a view of the influence of the dielectric function on the amplitude of the propagated field from the theoretical solution of the scalar wave equation considered within the ultra

violet, optical and near infrared. The advantage of this approach is clearly glaring as it provides a good picture of the field in a medium with variation of dielectric constant, refractive index and above all, the method requires no resolution of a system of equations as it can accommodate multiple layers easily.

2. Theoretical procedure

This our method is to find a solution $\psi(\mathbf{r})$ of the scalar wave equation

$$\nabla^2\psi(\mathbf{r})+\omega^2\epsilon_0\mu_0\epsilon(\mathbf{r})\psi(\mathbf{r}) = 0 \quad (1)$$

for arbitrary complex dielectric medium permittivity $\epsilon_p(\mathbf{r})$ of homogeneous permeability μ_0 starting with Hamiltonian. In equation (1) we assume the usual time dependence, $\exp(-i\omega t)$, for the electromagnetic field $\psi(\mathbf{r})$. Such a scalar field describes, for instance, the transverse electric modes propagating in thin media deposited on glass slide using solution growth technique (Ugwu, 2005).

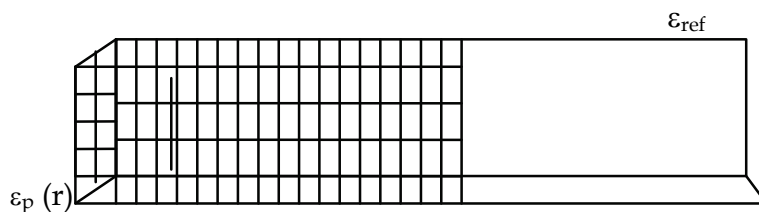

ϵ_{ref} is reference medium
 $\epsilon_p(\mathbf{r})$ is perturbed medium.

Fig. 1. Geometry used in the model. The dielectric medium for which we see a solution of the wave equation can be split into two parts; reference homogeneous medium, ϵ_{ref} , and a perturbed medium where the film is deposited $\epsilon_p(\mathbf{r})$

The assumption made here regarding the dielectric medium is that it is split into two parts; a homogenous reference medium of dielectric constant ϵ_{ref} and a perturbation $\epsilon_p(\mathbf{r})$ confined to the reference medium. Hence, the dielectric function of the system can be written as

$$\epsilon_p(\mathbf{r})=\epsilon_{ref}+\Delta\epsilon_p(\mathbf{r}) \quad (2)$$

Where $\Delta\epsilon_p(\mathbf{r}) = \epsilon_p(\mathbf{r}) - \epsilon_{ref}$. The assumption here can be fulfilled easily where both reference medium and the perturbation depend on the problem we are investigating. For example, if one is studying an optical fiber in vacuum, the reference medium is the vacuum and the perturbation describes the fiber. For a ridge wedge, wave guide the reference medium is the substrate and the perturbation is the ridge, In our own case in this work, the reference medium is air and the perturbing medium is thin film deposited on glass slide. Lippman-Schwinger equation is associated with the Hamiltonian H which goes with $H_0 + V$ Where H_0 is the Hamiltonian before the field penetrates the thin field and V is the interaction.

$$H_0\Phi_k\rangle = E_k\Phi_k\rangle \quad (3)$$

The eigenstate of $H_0 + V$ is the solution of

$$(E_k - H_0)\Psi_k(z) = V|\Psi_k(z)\rangle \quad (4a)$$

Here, z is the propagation distance as defined in the problem

$$|\Psi_k(z)\rangle = \left| \Phi_k + \frac{1}{E_k - H_0} \right| V|\Psi_k(z)\rangle \quad (4b)$$

Where η is the boundary condition placed on the Green's function $(E_k - H_0)^{-1}$. Since energy is conserved, the propagation field component of the solutions will have energy E_n with the boundary conditions that only handle the singularity when the eigenvalue of H_0 is equal to E_k . Thus we write;

$$|\Psi_k(z)\rangle = \left| \Phi_n + \frac{1}{E_k - H_0 + i\eta} \right| V|\Psi_k^f(z)\rangle \quad (5)$$

as the Lippman-Schwinger equation without singularity; where η is a positively infinitesimal, $|\Psi_k^f(z)\rangle$ is the propagating field in the film while $|\Psi_k^r(z)\rangle$ is the reflected. With the above equation (4) and (5) one can calculate the matrix elements with (z) and insert a complete set of z and Φ_k states as shown in equation (6).

$$\langle z|\Psi_k(z)\rangle = \langle z|\Phi_k\rangle + \int d^3z' \int \frac{d^3k'}{(2\pi)^3} \langle z|\frac{1}{E_k - H + i\eta}|\Phi_{k'}\rangle \langle \Phi_{k'}|J^1|z'\rangle \langle z'|\Psi_z \quad (6)$$

$$\Psi_k(z) = e^{fk} + \int d^3z' \int \frac{d^3k'}{(2\pi)^3} \frac{e^{-fk(z-z')}}{E_k - E_{k'} + i\eta} V(z')\Psi_k(z) \quad (7)$$

$$G(z) = \int \frac{d^3k'}{(2\pi)^3} \frac{e^{-fk(z-z')}}{E_k - E_{k'} + i\eta} \quad (8)$$

is the Green's Function for the problem, which is simplified as:

$$G(z) = \int \frac{m}{2\pi^2 h^2 z} \int_{-\infty}^{\infty} dk' \frac{\sin k'z}{K'^2 - (k + i\eta)^2} \quad (9)$$

When $\eta \approx 0$ is substituted in equation (9) we have

$$\Psi_k(z) = e^{ikz} - \frac{m}{2\pi^2 h^2} \int_{-\infty}^{\infty} d^3z' \frac{e^{ik(z-z')}}{|z-z'|} V(z')\Psi_k(z') \quad (10)$$

The perturbed term of the propagated field due to the inhomogeneous nature of the film occasioned by the solid-state properties of the film is:

$$\Psi_k(z) = -\frac{m}{2\pi^2 h^2} \int_{-\infty}^{+\infty} d^3z' \frac{e^{fk(z-z')}}{|z-z'|} V(z')\Psi_k(z') \quad (11a)$$

$$\Psi_k(z) = -\frac{1}{4\pi} \frac{2}{h^2} \Delta_{kk'} \quad (11b)$$

Where $\Delta_{kk'}$ is determined by variation of thickness of the thin film medium and the variation of the refractive index (Ugwu, et al 2007) at various boundary of propagation distance. As the field passes through the layers of the propagation distance, reflection and absorption of the field occurs thereby leading to the attenuation of the propagating field on the film medium. Blatt, 1968

3. Iterative application

Lippman-Schwinger equation can be written as

$$\Psi_k(z) = \Psi_k^o + \int dz' G^o \Delta \varepsilon_p(z') \Psi(z') \quad (12)$$

Where $G^o(z, z')$ is associated with the homogeneous reference system, (Yaghjian 1980) (Hanson, 1996) (Gao et al, 2006) (Gao and Kong 1983)

The function

$$V(z) = -k_o^2 \Delta \varepsilon_p(z) \quad (13)$$

define the perturbation

Where

$$k_o^2 = \frac{c^2}{\lambda^2} \varepsilon_o \mu_o \quad (14)$$

The integration domain of equation (12) is limited to the perturbation. Thus we observe that equation (12) is implicit in nature for all points located inside the perturbation. Once the field inside the perturbation is computed, it can be generated explicitly for any point of the reference medium. This can be done by defining a grid over the propagation distance of the film that is the thickness. We assume that the discretized system contains $\Delta_{kk'}$ defined by T/N.

Where T is thickness and N is integer

(N= 1, 2, 3, N - 1). The discretized form of equation (12) leads to large system of linear equation for the field;

$$\Psi_i = \Psi_i^o + \sum_{k=1}^{\Delta} G_{i,k}^o V_k \Delta_k \Psi_k \quad (15)$$

$$\Psi_i = \Psi_i^o + \sum_{k=1}^{\Delta} G_{i,k}^o V_k \Delta_k \Psi_i \quad (16)$$

However, the direct numerical resolution of equation (15) is time consuming and difficult due to singular behaviour of $G_{i,k}^o$. As a result, we use iterative scheme of Dyson's equation, which is the counter part of Lippman-Schwinger equation to obtain $G_{i,k}^o$. Equation 10 is easily solved by using Born approximation, which consists of taking the incident field in

place of the total field as the driving field at each point of the propagation distance. With this, the propagated field through the film thickness was computed and analyzed.

$$\Psi(z) = \Psi_o(z) e^{t(\lambda z - \omega t)} \quad (17)$$

From equation (1),

$$\text{Let } \lambda^2 = \mu_o \varepsilon_o \omega^2 \varepsilon_{ref} + i \mu_o \varepsilon_o \omega^2 \varepsilon_{ref} \Delta \varepsilon_p(z)$$

$$|\lambda^2 = [\varepsilon_{ref} + i \Delta \varepsilon_p(z)]^{1/2} \omega [\mu_o \varepsilon_o]^{1/2} \quad (18)$$

$$= k [\varepsilon_{ref} + \Delta \varepsilon_p(z)]^{1/2} \mu_o \varepsilon_o \left[\frac{1}{o} = (\mu_o \varepsilon_o)^{1/2} \right]$$

$$= k [\varepsilon_{ref} + \Delta \varepsilon_p(z)]^{1/2} \quad (19)$$

Expanding the expression up to 2 terms, we have

$$= k \left[\varepsilon_{ref} + \frac{1}{2} i \Delta \varepsilon_p \right] \quad (20)$$

Where $\Delta \varepsilon_p$ gives rise to exponential damping for all frequencies of field radiation of which its damping effect will be analyzed for various radiation wavelength ranging from optical to near infra-red

The relative amplitude

$$\frac{\psi(z)}{\psi_o(z)} = \exp\left(-\frac{K}{2} \Delta \varepsilon_p(z)\right) z \exp[ik\varepsilon_{ref} - \omega t] \quad (21)$$

Decomposing equation (3.18) into real and complex parts, we have the following

$$\frac{\psi(z)}{\psi^o(z)} = \left(\exp - \frac{K}{2} \Delta \varepsilon_p(z) \right) z \cos k\varepsilon_{ref} - \omega t \quad (22)$$

$$\frac{\psi(z)}{\psi^o(z)} = \left(\exp - \frac{K}{2} \Delta \varepsilon_p(z) \right) z \sin k\varepsilon_{ref} - \omega t \quad (23)$$

Considering a generalised solution of the wave equation with a damping factor

$$\psi(r) = \psi_o(r) \exp - \beta \exp - i(\alpha z - \omega t) \quad (24)$$

[Smith et al, 1982].

in which k_{ref} is the wave number β is the barrier whose values describe our model. With this, we obtain the expression for a plane wave propagating normally on the surface of the material in the direction of z inside the dielectric film material. Where $-\beta$ describes the barrier as considered in our model.

When a plane wave $\psi_o(z) = \exp(i k_{ref} z)$ with a wave number corresponding to the reference medium impinges upon the barrier, one part is transmitted, the other is reflected or in some cases absorbed (Martin et al 1994). This is easily obtained with our method as can be illustrated in Fig 2 present the relative amplitude of the computed field accordingly.

Three different cases are investigated:

- When the thin film medium is non absorbing, in this case $\Delta\epsilon_p(z)$ is considered to be relatively very small.
- When the film medium has a limited absorption, $\Delta\epsilon_p(z)$ is assumed to have a value slightly greater than that of (a)
- When the absorption is very strong, $\Delta\epsilon_p(z)$ has high value. In this first consideration, $\lambda_{\text{eff}} = 0.4\mu\text{m}, 0.70\mu\text{m}, 0.80\mu\text{m}$ and $0.90\mu\text{m}$ while $z = 0.5\mu\text{m}$ as a propagation distance in each case. In each case, the attenuation of the wave as a function of the absorption in the barrier is clearly visible in graphs as would be shown in the result.

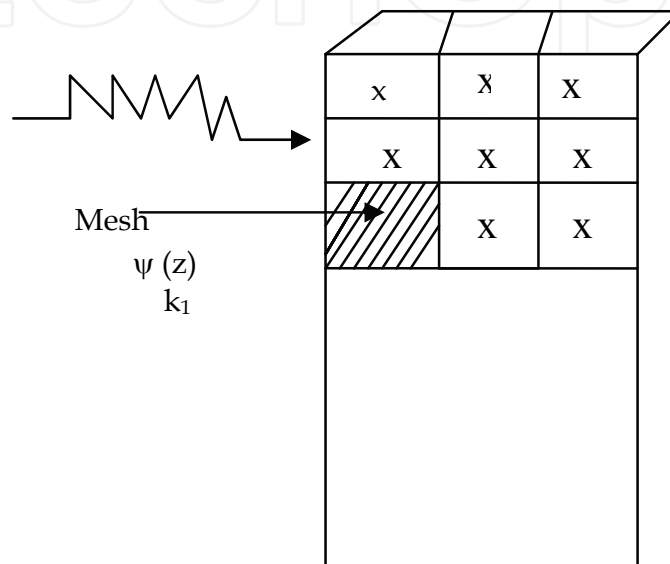

Fig. 2. Geometrical configuration of the model on which a wave propagates. The description is the same as in fig 1

4. Beam propagated on a mesh of the thin film

We consider the propagation of a high frequency beam through an inhomogeneous medium; the beam propagation method will be derived for a scalar field. This restricts the theory to cases in which the variation in refractive index is small or in which a scalar wave equation can be derived for the transverse electric, (T.E) or transverse magnetic, (T.M) modes separately. We start with the wave equation (Martin et al, 1994; Ugwu et al, 2007):

$$\nabla^2\psi + K^2n^2(z)\psi = 0 \quad (26a)$$

where ψ represents the scalar field, $n(z)$ the refractive index and K the wave number in vacuum. In equation 26a, the refractive index n^2 is split into an unperturbed part n_0^2 and a perturbed part Δn^2 ; this expression is given as

$$n^2(z) = n_0^2 + \Delta n^2(z) \quad (26b)$$

Thus

$$\nabla^2\psi + k^2n_0^2(z)\psi = \rho(z) \quad (27)$$

where $\rho(z)$ is considered the source function. The refractive index is $n^2_0 + \Delta n^2(z)$ and the refractive index $n^2_0(z)$ is chosen in such a way that the wave equation

$$\nabla^2 \psi + k^2 n^2_0(z) \psi = 0 \quad (29)$$

together with the radiation at infinity, can be solved. If a solution ψ for $z = z_0$ the field ψ and its derivative $\frac{\partial \psi}{\partial z}$ can be calculated for all values of z by means of an operator \hat{a} ;

$$\frac{\partial \psi}{\partial z} = \hat{a} \psi(x, y, z_0) \quad (30)$$

where the operator \hat{a} acts with respect to the transverse co-ordinate (x, y) only (VanRoey et al 1981)

We considered a beam propagating toward increasing z and assuming no paraxiality, for a given co-ordinate z , we split the field ψ into a part ψ_1 generated by the sources in the region where $z_1 < z$ and a part of ψ_2 that is due to sources with $z_1 > z$;

$$\Psi = \psi_1 + \psi_2 \quad (31)$$

An explicit expression for ψ_1 and ψ_2 can be obtained by using the function (Van Roey et al, 1981).

$$e_1(z/z_1) = \begin{cases} 0 & \text{for } z < z_1 \\ 1/2 & \text{for } z = z_1 \\ 1 & \text{for } z > z_1 \end{cases} \quad (32)$$

If G is the Green's function of equation 26a ψ_1 can be formally expressed as follows:

$$\psi_1(z) = \iiint_{-\infty}^{+\infty} G(z, z_1) e_1(z, z_1) \rho(z_1) d^3 z_1 \quad (33)$$

that leads to

$$\begin{aligned} \frac{\partial \psi_1}{\partial z} &= \iiint_{-\infty}^{+\infty} \frac{\partial G}{\partial z}(z, z_1) \rho(z_1) d^3 z_1 \\ &+ \iiint_{-\infty}^{+\infty} G(z, z_1) \delta(z - z_1) \rho(z_1) d^3 z_1 \end{aligned} \quad (34)$$

The first integral represents the propagation in the unperturbed medium, which can be written in terms of the operator \hat{a} defined in equation 34 as

$$\frac{\partial \psi(z)}{\partial z} = \hat{a} \psi_1 \quad (35)$$

and ψ_1 being generated by sources situated to the left of z .

The second part of the integral is written with assignment of an operator \mathcal{B} acting on ψ with respect to the transverse coordinate (x, y) only. Such that we have

$$\frac{\partial \Psi}{\partial z} = \hat{a}\Psi_1 + \hat{b}\Psi_2 \quad (36)$$

(Now neglecting the influence of the reflected field ψ_2 on ψ_1) we use ψ_1 instead of ψ_2 and equation 36 becomes

$$\frac{\partial \psi_1}{\partial z} = \hat{a}\psi_1 + \mathcal{B}\Psi \quad (37)$$

Equation 37 is an important approximation and restricts the use of the B.P.M to the analysis of structures for which the influence of the reflected fields on the forward propagation field can be neglected in equation (36) ψ_1 describes the propagation in an unperturbed medium and a correction term representing the influence of Δn . Since equation (30) is a first order differential equation, it is important as it allows us to compute the field ψ_1 for $z > z_0$ starting from the input beam on a plane of our model $z = z_0$. Simplifying the correction term (Van Roey et al, 1981), we have \mathcal{B}

$$\mathcal{B}\Psi_1 = -\frac{ik}{2n_0}\Delta n^2\Psi_1 \quad (38)$$

Equation 3.18 becomes

$$\frac{\partial \psi_1}{\partial z} = a\psi_1 = \frac{ik}{2n_0}\Delta n^2\psi_1 \quad (39)$$

The solution of this equation gives the propagation formalism that allows one propagate light beam in small steps through an inhomogeneous medium both in one and two dimensional cases which usually may extend to three dimension.

5. Analytical solution of the propagating wave with step-index

Equation 37 is an important approximation, though it restricts the use of the beam propagation method in analyzing the structures of matters for which only the forward propagating wave is considered. However, this excludes the use of the method in cases where the refractive index changes abruptly as a function of z or in which reflections add to equation (26). The propagation of the field ψ_1 is given by the term describing the propagation in an unperturbed medium and the correction term-representing the influence of $\Delta n^2(z)$ (Ugwu et al, 2007).

As the beam is propagated through a thin film showing a large step in refractive index of an imperfectly homogeneous thin film, this condition presents the enabling provisions for the use of a constant refractive index n_0 of the thin film. One then chooses arbitrarily two different refractive indices n_1 and n_2 at the two sides of the step so that

$$\left. \begin{aligned} n_0(z) &= n_1 & z < 0 \\ n_0(z) &= n_2 & z > 0 \end{aligned} \right\} \quad (40)$$

with $\frac{n(z) - n_0(z)}{n_0(z)} \gg 1$ for all z

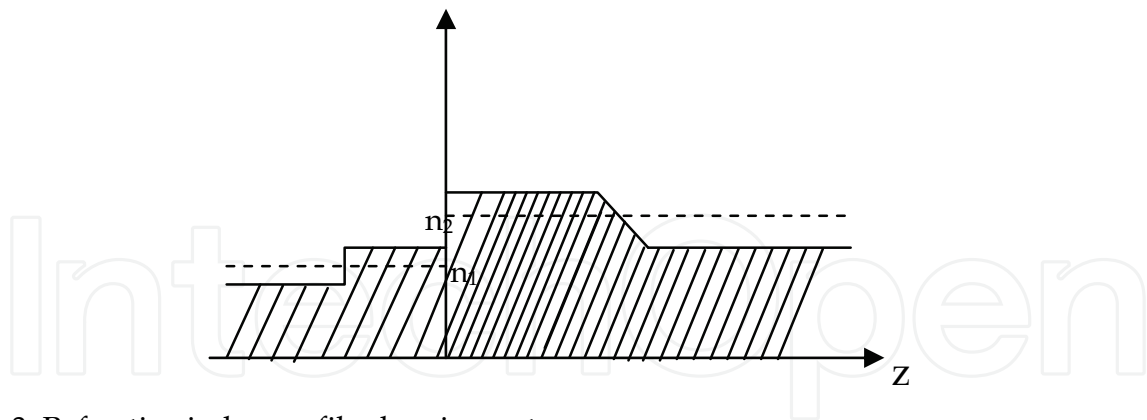

Fig. 3. Refractive index profile showing a step

The refractive index distribution of the thin film was assumed to obey the Fermi distribution that is an extensively good technique for calculating the mode index using the well known WKB approximation (Miyazowa et al,1975). The calculation is adjusted for the best fit to the value according to

$$n(z) = n_0 + \Delta n \left[\exp\left[\frac{z-d}{a}\right] - 1 \right]^{-1} \quad (41)$$

Small change in the refractive index over the film thickness can be obtained

Equation (41) represents the Fermi distribution, where $n(z)$ is the refractive index at a depth z below the thin surface, n_0 is the refractive index of the surface, Δn is the step change in the film thickness, z is average film thickness and "a" is the measure of the sharpness of the transition region (Ugwu et al, 2005).

With smoothly changing refractive index at both sides of the step, we assume that the sensitivity to polarization is due mainly to interface and hence in propagating a field ψ through such a medium, one has to decompose the field into (T.E) and (TM) polarized fields in which we neglect the coupling between the E and H fields due to small variation ($n-n_0$).

When the interface condition ψ_m and $\frac{\partial \Psi_m}{\partial z}$ are continuous at $z = 0$ are satisfied, the T.E field could be propagated by virtue of these decomposition. Similarly, TM fields were also propagated by considering that ψ_m and $\frac{\partial \Psi_m}{\partial z}$ were continuous at $z = 0$.

When we use a set or discrete modes, different sets of ψ_m can be obtained by the application of the periodic extension of the field. To obtain a square wave function for $n_0(z)$ as in fig 3.4, n_0 has to be considered periodic. We were primarily interested in the field guided at the interface $z = z_1$. The field radiated away from the interface was assumed not to influence the field in the adjacent region because of the presence of suitable absorber at $z = z - z_1$. The correction operator ∂ contains the perturbation term Δn^2 and as we considered it to be periodic function without any constant part as in equation 3.18. The phase variation of the correction term is the same such that the correction term provided a coupling between the two waves.

The Green's function as obtained in the equation (29) satisfies (1)

$$\left[\frac{\partial^2}{\partial x^2} + \frac{\partial^2}{\partial y^2} + \Delta n(y) \right] G(x, y) = \delta(x - x_1) \delta(y - y_1) \quad (42)$$

at the source point and satisfies (Ugwu et al, 2007) the impedance boundary condition.

$$G + B_o \frac{\partial G}{\partial n} = 0 \quad (43)$$

where $B_o = -\frac{iR_s}{\kappa R_o}$ s

and $R_o = \left[\frac{\mu}{\epsilon_o} \right]^{\frac{1}{2}}$

is the free space characteristic impedance, and $\partial/\partial n$ is the normal derivative. The impedance R_s offered to the propagating wave by the thin film is given by

$$R_s = \frac{R_o}{n} \left[1 - \frac{\kappa^2}{(\kappa_o n)^2} \right]^{\frac{1}{2}} \quad (44)$$

$$R = \frac{R_o}{n} \left[1 - \frac{1}{n^2} \right] \quad (45)$$

where n is the average refractive index of the film (Wait, 1998; Bass et al, 1979) κ is the wave-number of the wave in the thin film where κ_o is the wave number of the wave in the free space. For every given wave with a wavelength say λ propagating through the film with the appropriate refractive index n , the impedance R of the film can be computed using equation (44) When κ is equal to κ_o we have equation (45) and when n is relatively large $|n|$

6. Integral method

The integral form of Lippmann-Schwinger as given in equation 12 may be solved analytically as Fredholm problem if the kernel $k(z, z') = G(z, z')V(z')$ is separable, but due to the implicit nature of the equation as $\psi(z')$ is unknown, we now use Born approximation method to make the equation explicit. This simply implies using $\psi_o(z)$ in place of $\psi(z')$ to start the numerical integration that would enable us to obtain the field propagating through the film.

In the solution of the problem, we considered $\Psi_0(z)$ as the field corresponding to homogeneous medium without perturbation and then work to obtain the field $\Psi_0(z)$ corresponding to the perturbed system (6) is facilitated by introducing the dyadic Green's function associated with the reference system is as written in equation (12). However, to do this we first all introduce Dyson's equation, the counterpart of Lippmann-Schwinger equation to enable us compute the value of the Green's function over the perturbation for own ward use in the computation of the propagation field.

Now, we note that both Lippmann-Schwinger and Dyson's equation are implicit in nature for all points located inside the perturbation and as a result, the solution is handle by applying Born Approximation method as already mentioned before now

7. Numerical consideration

In this method, we defined a grid over the system as in fig 3 this description, we can now write Lippmann-Schwinger and Dyson's equations as:

$$\Psi_1 = \Psi_1^0 + \sum_{k=1}^{N_p} G_{1,k}^0 V_k \Delta_k \Psi_k \quad (45)$$

$$G_{i,j} = G_{i,j}^0 + \sum_{k=1}^{N_p} G_{i,k}^0 v_k \Delta_k G_k \quad (46)$$

The discretization procedure is identical in one, two, or three dimensions; for clarity, we use only one segment to designate the position of a mesh and we assume it to be k and we assume also that the discretized system contains N meshes from which N_p describes the meshes, $N_p \leq N$, we denote the discretized field. The formulation of the matrix in equations (46) leads to the solution G_s that would be used in building up the matrix in (46) which eventually makes it possible to obtain the propagating field. Also the number of the matrices obtained will depend on the number meshes considered

For instant if 3 meshes are considered, 9 algebraic equations as

$$\begin{aligned} G_{1,1} &= G_{0,1,1} + G_{0,1,1} V_1 \Delta_1 G_{1,1} + G_{0,2,2} V_2 \Delta_2 G_{2,1} + G_{0,1,3} V_3 \Delta_3 G_{3,1} & a \\ G_{2,1} &= G_{0,2,1} + G_{0,2,1} V_1 \Delta_1 G_{1,1} + G_{0,2,2} V_2 \Delta_2 G_{2,1} + G_{0,2,3} V_3 \Delta_3 G_{3,1} & b \\ G_{3,1} &= G_{0,2,2} + G_{0,3,1} V_1 \Delta_1 G_{1,1} + G_{0,3,2} V_2 \Delta_2 G_{2,1} + G_{0,3,3} V_3 \Delta_3 G_{3,1} & c \\ G_{1,2} &= G_{0,1,2} + G_{0,1,1} V_1 \Delta_1 G_{1,2} + G_{0,1,2} V_2 \Delta_2 G_{2,2} + G_{0,1,3} V_3 \Delta_3 G_{3,2} & d \\ G_{2,2} &= G_{0,2,2} + G_{0,2,1} V_1 \Delta_1 G_{1,2} + G_{0,2,2} V_2 \Delta_2 G_{2,2} + G_{0,2,3} V_3 \Delta_3 G_{3,2} & e \\ G_{3,2} &= G_{0,3,2} + G_{0,3,1} V_1 \Delta_1 G_{1,2} + G_{0,3,2} V_2 \Delta_2 G_{2,2} + G_{0,3,3} V_3 \Delta_3 G_{3,2} & f \\ G_{1,3} &= G_{0,1,3} + G_{0,1,1} V_1 \Delta_1 G_{1,3} + G_{0,1,2} V_2 \Delta_2 G_{2,3} + G_{0,1,3} V_3 \Delta_3 G_{3,3} & g \\ G_{2,3} &= G_{0,2,3} + G_{0,2,1} V_1 \Delta_1 G_{1,3} + G_{0,2,2} V_2 \Delta_2 G_{2,3} + G_{0,2,3} V_3 \Delta_3 G_{3,3} & h \\ G_{3,3} &= G_{0,3,3} + G_{0,3,1} V_1 \Delta_1 G_{1,3} + G_{0,3,2} V_2 \Delta_2 G_{2,3} + G_{0,3,3} V_3 \Delta_3 G_{3,3} & i \end{aligned} \quad (47)$$

Are generated and from that 9×9 matrix is formulated from where one can obtain nine values of G_{ij}

$G_{1,1}, G_{1,2}, G_{1,3}, G_{2,1}, G_{2,2}, G_{2,3}, G_{3,1}, G_{3,2}, G_{3,3}$. Using these G_s , one generates three algebraic equations in terms of field as shown below.

$$\begin{aligned} \Psi_1 &= \Psi_1^0 + G_{1,1}^0 V_1 \Delta_1 \Psi_1 + G_{1,2}^0 V_2 \Delta_2 \Psi_2 + G_{1,3}^0 V_3 \Delta_3 \Psi_3 \\ \Psi_2 &= \Psi_2^0 + G_{2,1}^0 V_1 \Delta_1 \Psi_1 + G_{2,2}^0 V_2 \Delta_2 \Psi_2 + G_{2,3}^0 V_3 \Delta_3 \Psi_3 \\ \Psi_3 &= \Psi_3^0 + G_{3,1}^0 V_1 \Delta_1 \Psi_1 + G_{3,2}^0 V_2 \Delta_2 \Psi_2 + G_{3,3}^0 V_3 \Delta_3 \Psi_3 \end{aligned}$$

The compact matrix form of the equation can be written thus,

$$\begin{bmatrix} 1 - G_{1,1}^0 V_1 \Delta_1 - G_{1,2}^0 V_2 \Delta_2 - G_{1,3}^0 V_3 \Delta_3 \\ -G_{2,1}^0 V_1 \Delta_1 - 1 - G_{2,2}^0 V_2 \Delta_2 - G_{2,3}^0 V_3 \Delta_3 \\ -G_{3,1}^0 V_1 \Delta_1 - G_{3,2}^0 V_2 \Delta_2 - 1 - G_{3,3}^0 V_3 \Delta_3 \end{bmatrix} \begin{bmatrix} \Psi_1 \\ \Psi_2 \\ \Psi_3 \end{bmatrix} = \begin{bmatrix} \Psi_1^0 \\ \Psi_2^0 \\ \Psi_3^0 \end{bmatrix} \quad (48)$$

8. Result/discussion

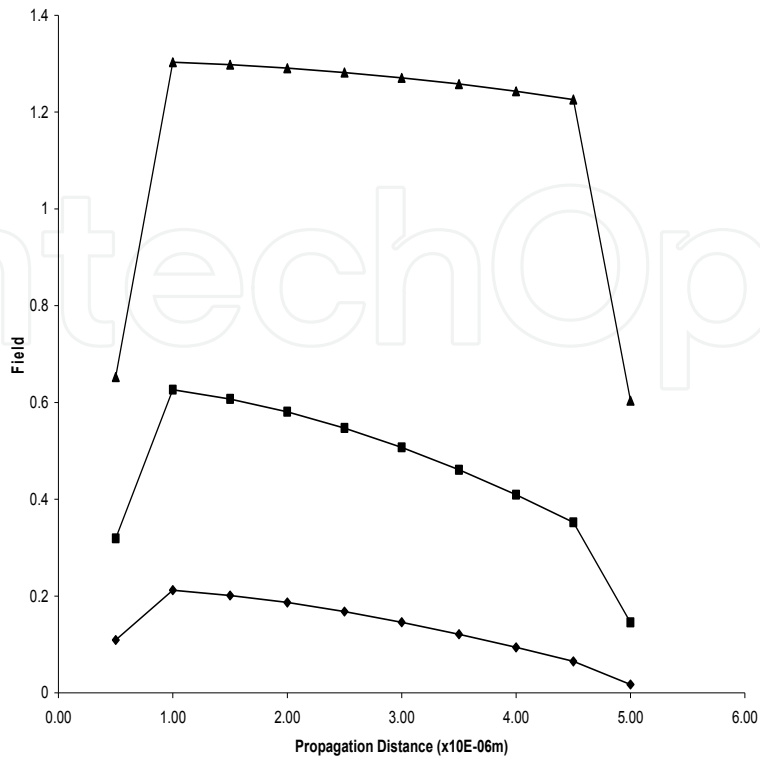

Fig. 1. The field behaviour as it propagates through the film thickness $Z\mu\text{m}$ for mesh size = 10 when $\lambda = 0.4\mu\text{m}$, $0.7\mu\text{m}$ and $0.9\mu\text{m}$.

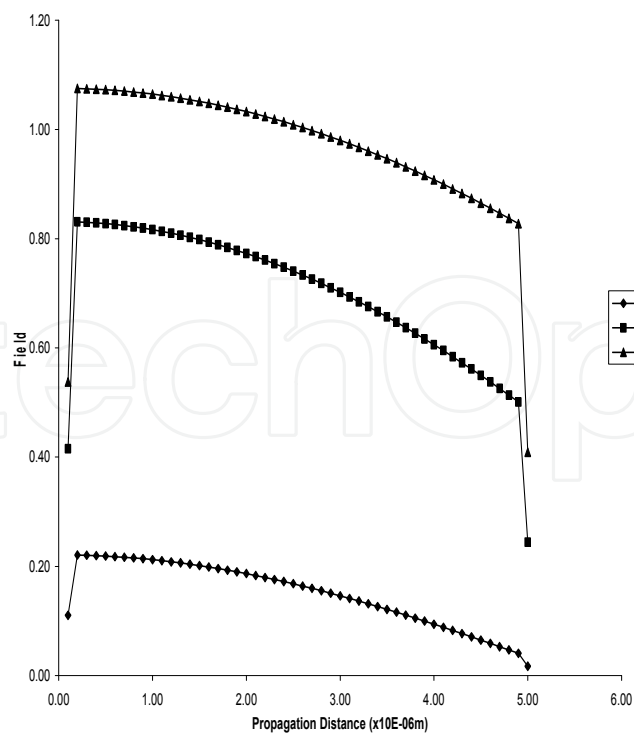

Fig. 2. The field behaviour as it propagates through the film thickness $Z\mu\text{m}$ for mesh size = 50 when $\lambda = 0.25\mu\text{m}$, $0.7\mu\text{m}$ and $0.9\mu\text{m}$.

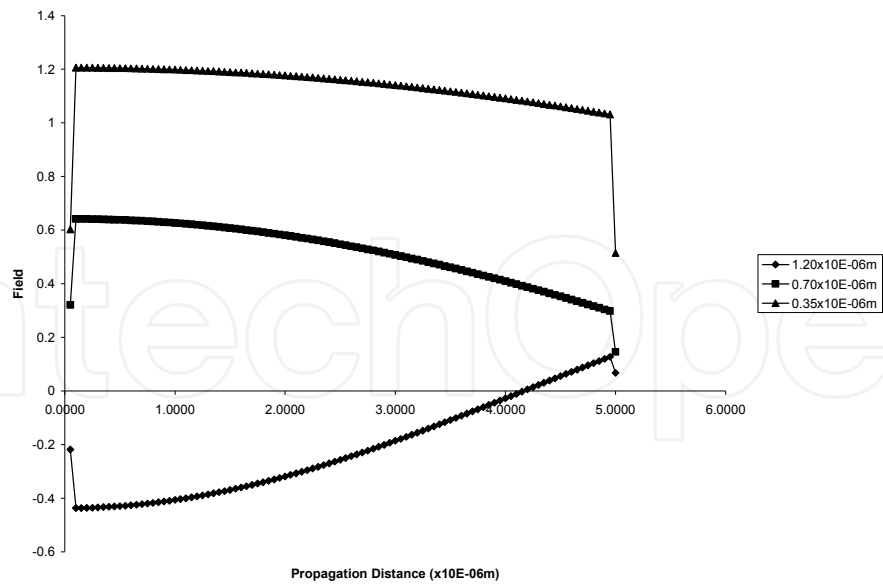

Fig. 3. The field behaviour as it propagates through the film thickness $Z\mu\text{m}$ for mesh size = 50 when $\lambda = 0.25\mu\text{m}$, $0.7\mu\text{m}$ and $0.9\mu\text{m}$.

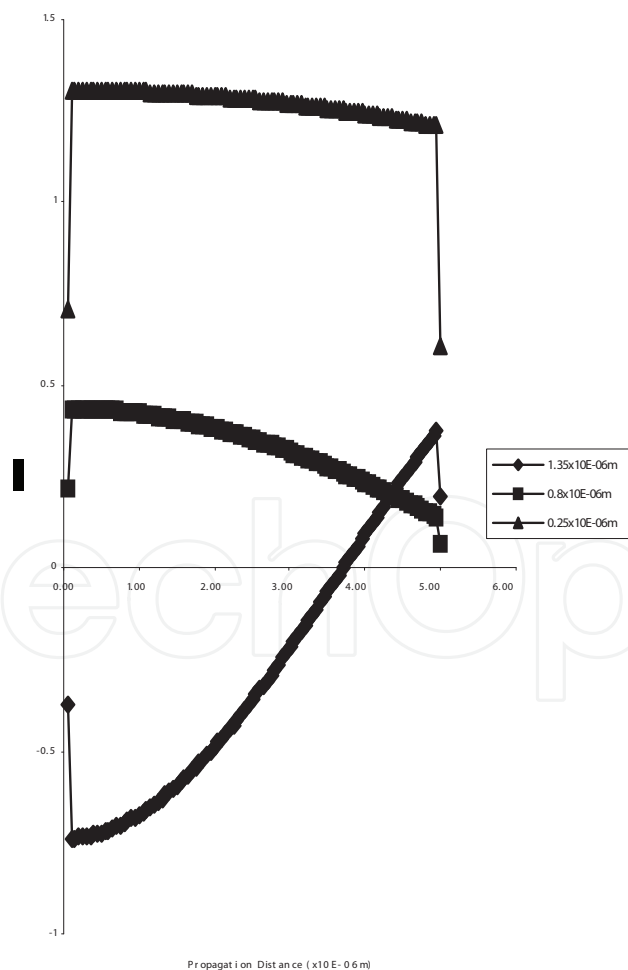

Fig. 4. The field behaviour as it propagates through the film thickness $Z\mu\text{m}$ for mesh size = 100 when $\lambda = 0.25\mu\text{m}$, $0.8\mu\text{m}$ and $1.35\mu\text{m}$.

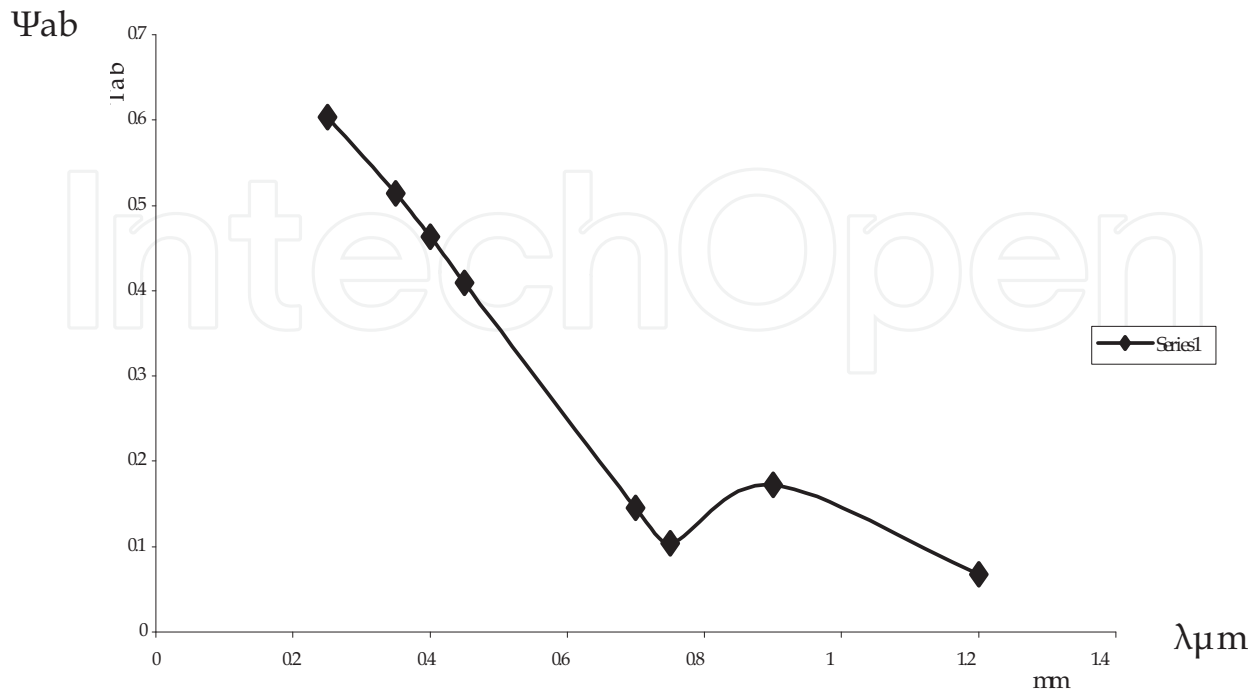

Fig. 5. The filed absorbance as a function wavelength.

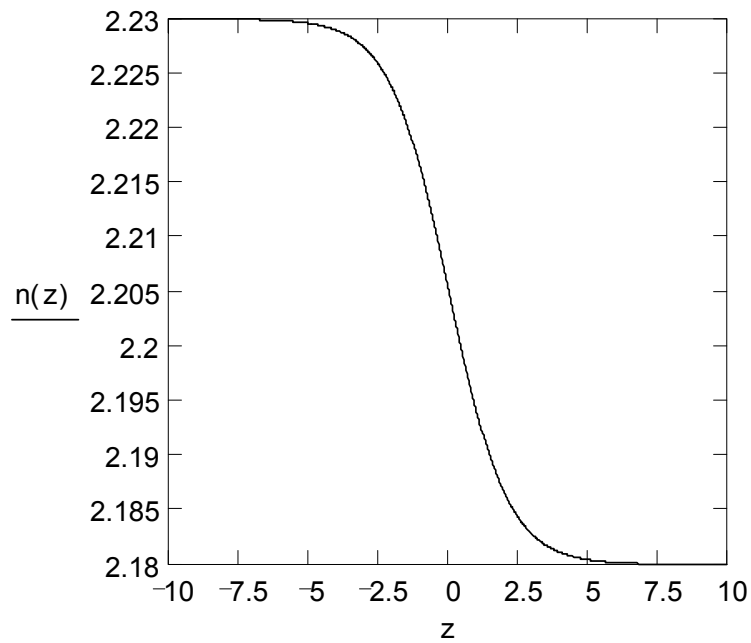

Fig. 6. Refractive index profile using Fermi distribution

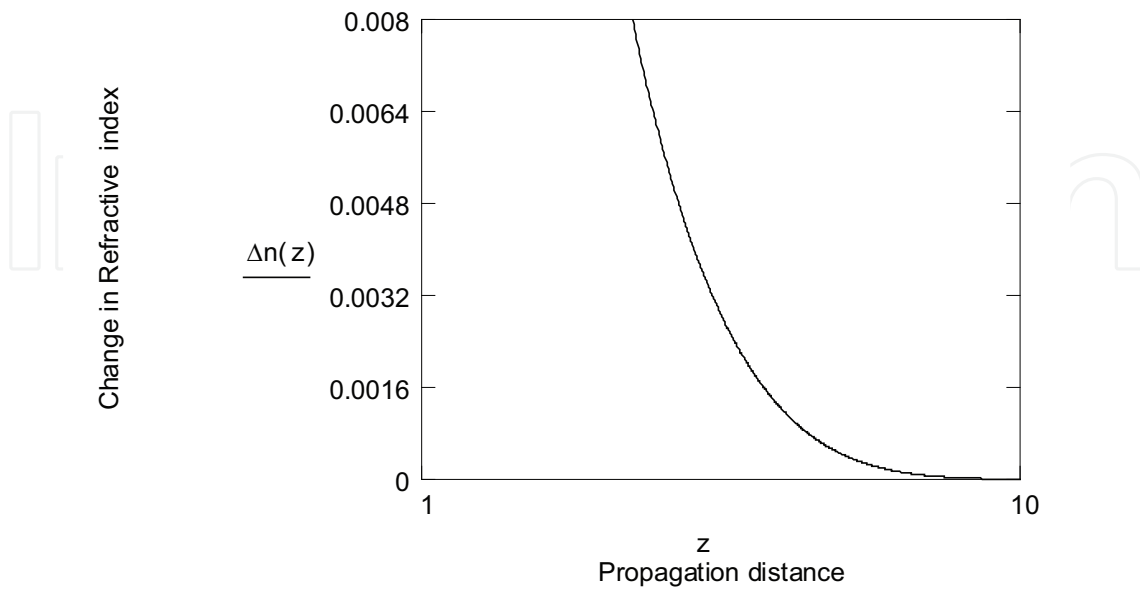

Fig. 7. Graph of change in Refractive Index as a function of a propagation distance

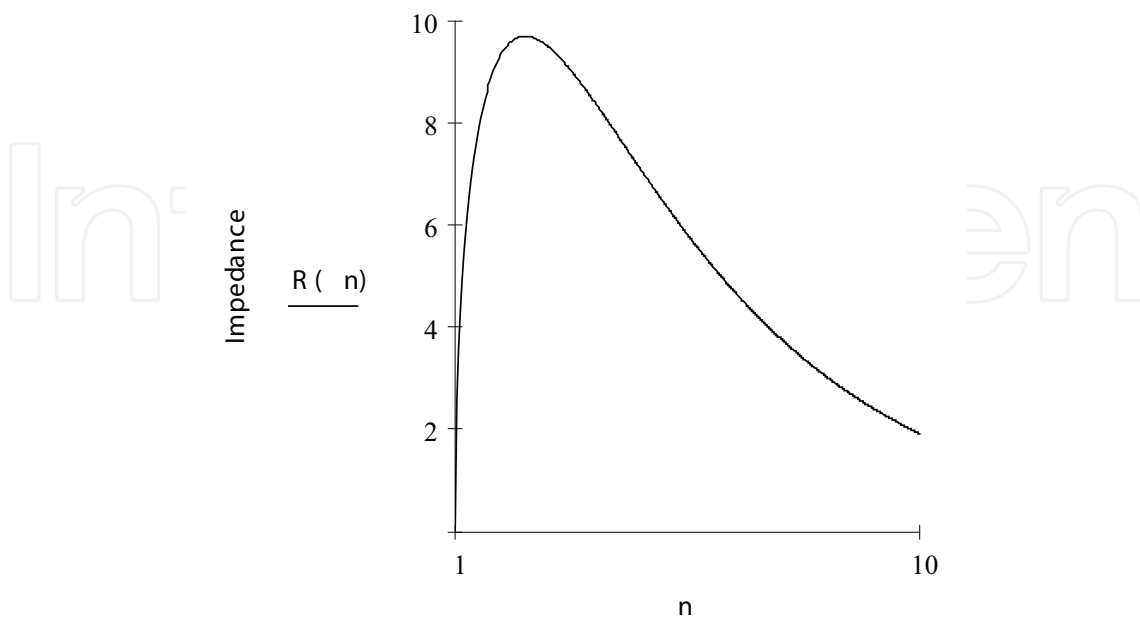

Fig. 8. Graph of Impedance against *Refractive Index* when $k = k_0$

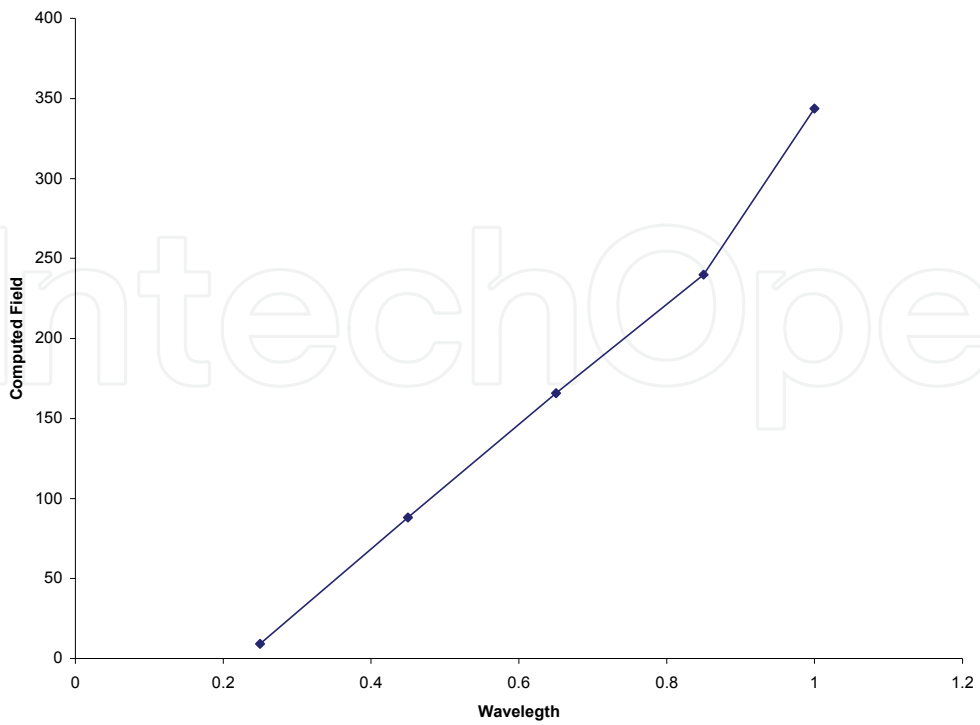

Fig. 9. Computed field against wavelength when the mesh size is constant

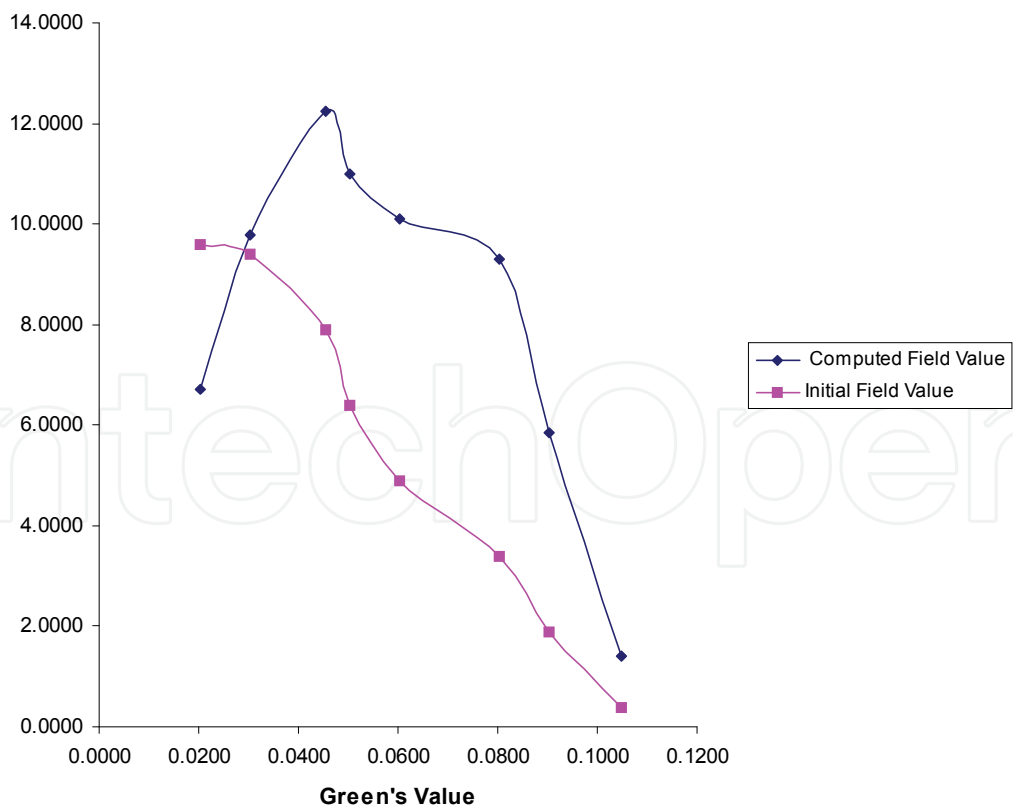

Fig. 10. Computed and Initial field values in relation to the Green's value within the uv region

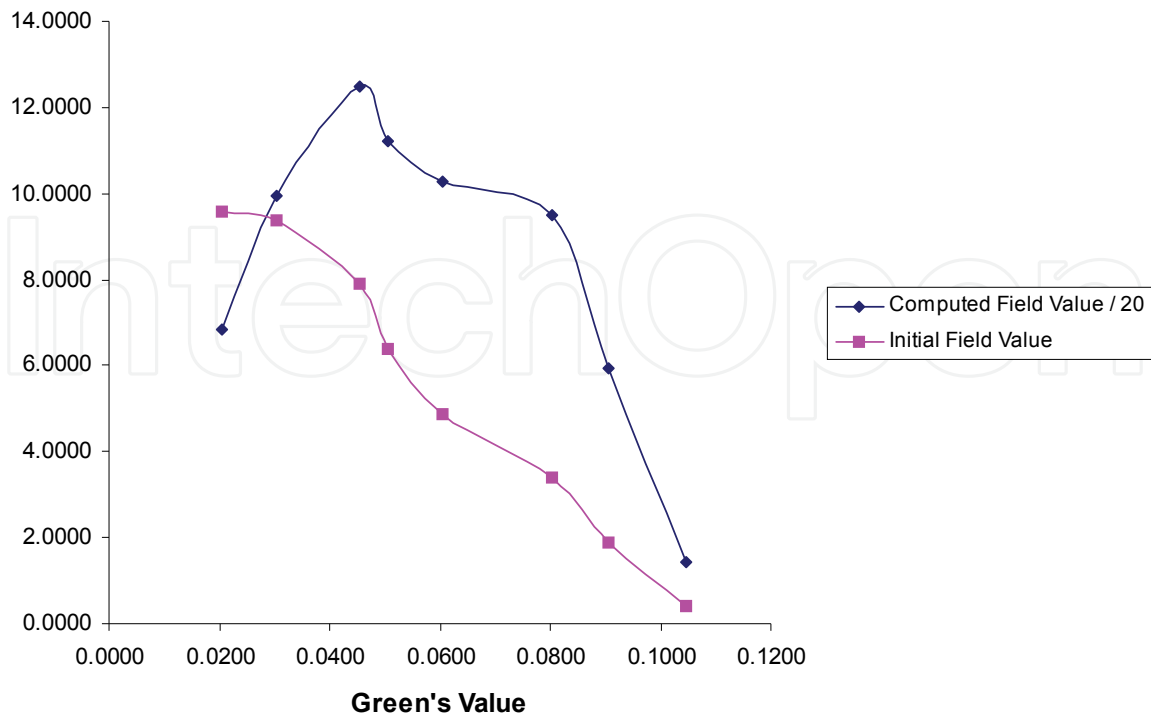

Fig. 11. Computed and Initial field values in relation to the Green's value within the near infrared region

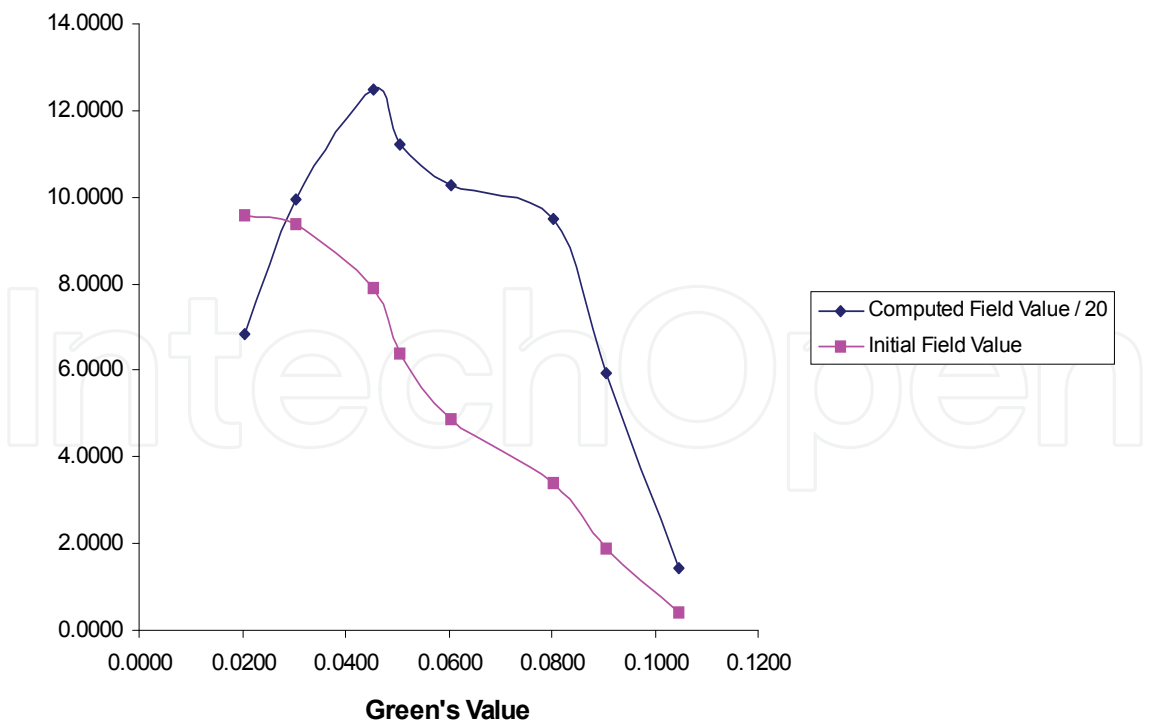

Fig. 12. Computed and Initial field values in relation to the Green's value within the visible region

From the result obtained using this formalism, the field behaviour over a finite distance was contained and analyzed by applying born approximation method in Lippman-Schwinger equation involving step by step process. The result yielded reasonable values in relation to the experimental result of the absorption behaviour of the thin film (Ugwu, 2001).

The splitting of the thickness into more finite size had not much affected on the behaviour of the field as regarded the absorption trends.

The trend of the graph obtained from the result indicated that the field behaviour have the same pattern for all mesh size used in the computation. Though, there is slight fall in absorption within the optical region, the trend of the graph look alike when the thickness is $1.0 \mu\text{m}$ with minimum absorption occurring when the thickness is $0.5 \mu\text{m}$. within the near infrared range and ultraviolet range, ($0.25 \mu\text{m}$) the absorption rose sharply, reaching a maximum of 1.48 and 1.42 respectively when thickness is $1.0 \mu\text{m}$ having value greater than unity.

From the behaviour of the propagated field for the specified region, UV, Visible and Near infrared, (Ugwu, 2001) the propagation characteristic within the optical and near infrared regions was lower when compared to UV region counterpart irrespective of the mesh size and the number of points the thickness is divided. The field behaviour was unique within the thin film as observed in fig. 3 and fig 4: for wavelength $1.2\mu\text{m}$ and $1.35\mu\text{m}$

while that of fig,1 and fig.2 were different as the wave patterns were shown within the positive portion of the graph. The field unique behavior within the film medium as observed in the graphs in fig.1 to fig.4 for all the wave length and N_{max} suggests the influence of scattering and reflection of the propagated field produced by the particles of the thin field medium. The peak as seen in the graphs is as a result of the first encounter of the individual molecules of the thin film with the incident radiation. The radiation experiences scattering by the individual molecules at first conforming to Born and Huang, 1954 where it was explained that when a molecule initially in a normal state is excited, it generates spontaneous radiation of a given frequency that goes on to enhance the incident radiation This is because small part of the scattered incident radiation combines with the primary incident wave resulting in phase change that is tantamount to alternation of the wave velocity in the thin film medium. One expects this peak to be maintained, but it stabilized as the propagation continued due to fact that non-forward scattered radiation is lost from the transmitted wave(Sanders,19980) since the thin film medium is considered to be optically homogeneous, non-forward scattered wave is lost on the account of destructive interference. In contrast, the radiation scattered into the forward direction from any point in the medium interferes constructively (Fabelinskii, 1968)

We also observed in each case that the initial value of the propagation distance $z\mu\text{m}$, initial value of the propagating field is low, but increase sharply as the propagation distance increases within the medium suggesting the influence of scattering and reflection of propagating field produced by the particles of the thin film as it propagates. Again, as high absorption is observed within the ultraviolet (UV) range as depicted in fig.5, the thin film could be used as UV filter on any system the film is coated with as it showed high absorption. On other hand, it was seen that the absorption within the optical (VIS) and near infrared (NIR) regions of solar radiation was low. Fig.6 depicts the refractive index profile according to equation (41) while that of the change in refractive index with propagation distant is shown on figs.7. The impedance appears to have a peak at lower refractive index as shown in fig. 8. Fig. 9 shows the field profile for a constant mesh size while that of Fig.10

to fig.12 are profile for the three considered regions of electromagnetic radiation as obtained from the numerical consideration.

9. Conclusion

A theoretical approach to the computation and analysis of the optical properties of thin film were presented using beam propagation method where Green's function, Lippmann-Schwinger and Dyson's equations were used to solve scalar wave equation that was considered to be incident to the thin film medium with three considerations of the thin film behaviour. These includes within the three regions of the electromagnetic radiation namely: ultra violet, visible and infrared regions of the electromagnetic radiation with a consideration of the impedance offered to the propagation of the field by the thin film medium.

Also, a situation where the thin film had a small variation of refractive index profile that was to have effect on behaviour of the propagated field was analyzed with the small variation in the refractive index. The refractive index was presented as a small perturbation. This problem was solved using series solution on Green's function by considering some boundary conditions (Ugwu et al 2007). Fermi distribution function was used to illustrate the refractive index profile variation from where one drew a close relation that facilitated an expression that led to the analysis of the impedance of the thin film

The computational technique facilitated the solution of field values associated first with the reference medium using the appropriate boundary conditions on Lippmann-Schwinger equation on which dyadic Green's operator was introduced and born approximation method was applied both Lippmann-Schwinger and Dyson's equations. These led to the analysis of the propagated field profile through the thin film medium step by step.

10. Reference

- [1] A.B Cody, G. Brook and Abele 1982 "Optical Absorption above the Optical Gap of Amorphous Silicon Hydride". Solar Energy material, 231-240.
- [2] A.D Yaghjian 1980 "Electric dynamic green's functions in the source region's Proc IEEE 68,248-263.
- [3] Abeles F. 1950 "Investigations on Propagation of Sinusoidal Electromagnetic Waves in Stratified Media Application to Thin Films", Ann Phy (Paris) 5 596- 640.
- [4] Born M and Huang K 1954, Dynamical theory of crystal lattice Oxford Clarendon
- [5] Born, M and Wolf E, 1980, "Principle of optics" 6th Ed, Pergamon N Y.
- [6] Brykhoverstskii, A.S, Tigrov,M and I.M Fuks 1985 "Effective Impendence Tension Of Computing Exactly the Total Field Propagating in Dielectric Structure of arbitrary shape". J. opt soc Am A vol 11, No3 1073-1080.
- [7] E.I. Ugwu 2005 "Effects of the electrical conductivity of thin film on electromagnetic wave propagation. JICCOTECH Maiden Edition. 121-127.
- [8] E.I. Ugwu, C.E Okeke and S.I Okeke 2001."Study of the UV/optical properties of FeS₂ thin film Deposited by solution Growth techniques JEAS Vol1 No. 13-20.
- [9] E.I. Ugwu, P.C Uduh and G.A Agbo 2007 "The effect of change in refractive index on wave propagation through (feS₂) thin film". Journal of Applied Sc.7 (4). 570-574.
- [10] E.N Economou 1979 "Green's functions in Quantum physics", 1st. Ed. Springer. Verlag, Berlin.

- [11] F.J Blatt 1968 "Physics of Electronic conduction in solid". Mc Graw - Hill Book Co Ltd New York, 335-350.
- [12] Fablinskii I. L, 1968 Molecular scattering of light New York Plenum Press.
- [13] Fitzpatrick, .R, (2002), "Electromagnetic wave propagation in dielectrics". <http://farside.ph.utexas.edu/teaching/jkl/lectures/node79.html>. Pp 130 - 138.
- [14] G. Gao, C Tores - Verdin and T.M Hat 2005 "Analytical Techniques to evaluate the integration of 3D and 2D spatial Dyadic Green's function" *progress in Electromagnetic Research PIER* 52, 47-80.
- [15] G.W. Hanson 1996 "A Numerical formation of Dyadic Green's functions for planar Bianisotropic Media with Application to printed Transmission line" *IEEE Transaction on Microwave theory and techniques*, 44(1).
- [16] H.L Ong 1993 "2x2 propagation matrix for electromagnetic waves propagating obliquely in layered inhomogeneous uniaxial media" *J.Optical Science A*/10(2). 283-393.
- [17] Hanson, G W, (1996), "A numerical formulation of Dyadic Green's functions for Planar Bianisotropic Media with Application to Printed Transmission lines". S 0018 - 9480 (96) 00469-3 *IEEE pp*144 - 151.
- [18] J.A Fleck, J.R Morris and M.D. Feit 1976 "Time - dependent propagation of high energy laser beams through the atmosphere" *Applied phys* 10,129-160.
- [19] L. Thylen and C.M Lee 1992 "Beam propagation method based on matrix digitalization" *J. optical science A*/9 (1). 142-146.
- [20] Lee, J.K and Kong J.A 1983 Dyadic Green's Functions for layered an isotropic medium. *Electromagn.* Vol 3 pp 111-130.
- [21] M.D Feit and J.A Fleck 1978 "Light propagation in graded - index optical fibers" *Applied optical*17, 3990-3998.
- [22] Martin J F Oliver, Alain Dereux and Christian Girard 1994 "Alternative Scheme of
- [23] P.A. Cox 1978 "The electronic structure and Chemistry of solids "Oxford University Press Ch. 1-3. Plenum Press ; New York Press.
- [24] Sanders P.G.H,1980 *Fundamental Interaction and Structure of matters: 1st edition*
- [25] Smith E.G. and Thomos J.H., 1982. "Optics ELBS and John Wiley and Sons Ltd London. Statically Rough Ideally Conductive Surface. *Radiophys. Quantum Electro* 703 -708

IntechOpen

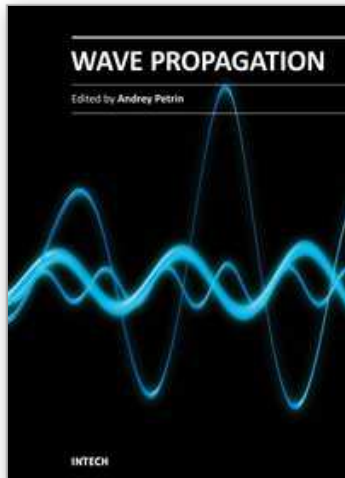

Wave Propagation

Edited by Dr. Andrey Petrin

ISBN 978-953-307-275-3

Hard cover, 570 pages

Publisher InTech

Published online 16, March, 2011

Published in print edition March, 2011

The book collects original and innovative research studies of the experienced and actively working scientists in the field of wave propagation which produced new methods in this area of research and obtained new and important results. Every chapter of this book is the result of the authors achieved in the particular field of research. The themes of the studies vary from investigation on modern applications such as metamaterials, photonic crystals and nanofocusing of light to the traditional engineering applications of electrodynamics such as antennas, waveguides and radar investigations.

How to reference

In order to correctly reference this scholarly work, feel free to copy and paste the following:

E. I. Ugwu (2011). Wave Propagation in Dielectric Medium Thin Film Medium, Wave Propagation, Dr. Andrey Petrin (Ed.), ISBN: 978-953-307-275-3, InTech, Available from: <http://www.intechopen.com/books/wave-propagation/wave-propagation-in-dielectric-medium-thin-film-medium>

INTECH
open science | open minds

InTech Europe

University Campus STeP Ri
Slavka Krautzeka 83/A
51000 Rijeka, Croatia
Phone: +385 (51) 770 447
Fax: +385 (51) 686 166
www.intechopen.com

InTech China

Unit 405, Office Block, Hotel Equatorial Shanghai
No.65, Yan An Road (West), Shanghai, 200040, China
中国上海市延安西路65号上海国际贵都大饭店办公楼405单元
Phone: +86-21-62489820
Fax: +86-21-62489821

© 2011 The Author(s). Licensee IntechOpen. This chapter is distributed under the terms of the [Creative Commons Attribution-NonCommercial-ShareAlike-3.0 License](#), which permits use, distribution and reproduction for non-commercial purposes, provided the original is properly cited and derivative works building on this content are distributed under the same license.

IntechOpen

IntechOpen