

We are IntechOpen, the world's leading publisher of Open Access books Built by scientists, for scientists

4,800

Open access books available

122,000

International authors and editors

135M

Downloads

Our authors are among the

154

Countries delivered to

TOP 1%

most cited scientists

12.2%

Contributors from top 500 universities



WEB OF SCIENCE™

Selection of our books indexed in the Book Citation Index
in Web of Science™ Core Collection (BKCI)

Interested in publishing with us?
Contact book.department@intechopen.com

Numbers displayed above are based on latest data collected.
For more information visit www.intechopen.com



Image Quality Improvement of Digital Holography by Multiple Wavelengths or Multiple Holograms

Takanori Nomura
Wakayama University
Japan

1. Introduction

Digital holography (Yamaguchi & Zhang, 1997; Osten et al., 2002; Kreis, 2005; Ferraro et al., 2005; Frauel et al., 2006; Nomura & Imbe, 2010) is a useful technique for recording the fully complex field of a wavefront. In line with advances in imaging devices such as CCDs, digital holography is accessible. The digital holography has been used for lots of applications including encryption (Javidi & Nomura, 2000; Tajauerce & Javidi, 2000; Nomura et al., 2004) and three-dimensional object recognition (Poon & Kim, 1999; Tajauerce et al., 2001; Javidi & Kim, 2005). However, the quality of a reconstructed image of a digital hologram is not good, because it is suffering from speckles. Comparing a conventional film hologram, the extent of a digital hologram is small and the resolution of the hologram is low in single figure. This is why the reconstructed image has noticeable speckles. To reduce the speckles, some signal processing approaches have been proposed (Javidi et al., 2005; Do et al., 2005; Maycock et al., 2005; Kreis & Schlüter, 2007). By use of wavelet decomposition, three-dimensional image fusion has been proposed and some speckles reduction has been achieved. Independent component analysis has been also applied to reduce speckles. Aperture synthesis approach is also proposed to enhance the resolution. Somewhat speckle noises have been reduced by the approaches.

In this paper, two methods to reduce speckle of the reconstructed image are presented. One is the method based on the superposition of the reconstructed images with different wavelengths. Another is the method based on the multiple holograms. In Section 2, the characteristics of speckles are reviewed briefly. In Section 3, the former method is described. Some experimental results are shown to confirm the proposed method. In Section 4, the latter method is described with some experimental results for confirmation.

2. Speckle size in digital holography

Let $g(x_0, y_0)$ denote a complex field of an object wave at the object plane (x_0, y_0) . At a distance of d from an object, the complex field is given by (Nomura et al., 2008)

$$u(X, Y) = \exp\left(i\frac{2\pi}{\lambda} \frac{X^2 + Y^2}{2d}\right) \mathcal{F} \left[g(x_0, y_0) \exp\left(i\frac{2\pi}{\lambda} \frac{x_0^2 + y_0^2}{2d}\right) \right], \quad (1)$$

where λ denotes a wavelength. The notation \mathcal{F} denotes a Fourier transform operation. The digital hologram has a finite extent due to the extent of an imaging device. Let us assume that

the extent is $a \times b$. Therefore the digital hologram can be written as

$$u'(X, Y) = u(X, Y) \text{rect} \left(\frac{X}{a} \right) \text{rect} \left(\frac{Y}{b} \right). \quad (2)$$

The complex field of the reconstructed object $U(x, y)$ can be calculated by

$$\begin{aligned} U(x, y) &= \exp \left(-i \frac{2\pi}{\lambda} \frac{x^2 + y^2}{2d} \right) \mathcal{F} \left[u'(X, Y) \exp \left(-i \frac{2\pi}{\lambda} \frac{X^2 + Y^2}{2d} \right) \right] \\ &= \exp \left(-i \frac{2\pi}{\lambda} \frac{x^2 + y^2}{2d} \right) \left\{ g(x_0, y_0) \exp \left(i \frac{2\pi}{\lambda} \frac{x_0^2 + y_0^2}{2d} \right) * \text{sinc} \left(\frac{ax_0}{\lambda d} \right) \text{sinc} \left(\frac{by_0}{\lambda d} \right) \right\}, \end{aligned} \quad (3)$$

where the notation $*$ denotes a convolution operation. From Eq. (3), the reconstructed object is given by a convolution between the original complex field and a sinc function determined by the extent of the imaging device. If the speckle size is defined as a full width at half maximum of the main lobe of the sinc function, the size of the speckle ΔS_x and ΔS_y are approximately given by

$$\Delta S_x = \frac{\lambda d}{a}, \quad (4)$$

$$\Delta S_y = \frac{\lambda d}{b}, \quad (5)$$

respectively. These relations are also shown in the literature (Kreis, 2005). The speckle spoils the quality of the reconstructed image. To improve the quality, two approaches are considered. One approach is to make the effect weaken. Another approach is to reduce the size of the speckle using large $a \times b$ based on a synthetic aperture. In the following Sections, both approaches are described.

3. Speckles reduction by multiple wavelengths

3.1 Speckle model and reconstructed image with multiple wavelengths

If digital holograms with different wavelengths are recorded, the shape and the position of speckles are different from each other, because the complex field of the diffracted wave depends on the wavelength based on Eq. (1). Here it is assumed that the shape and the position of the speckles are randomly changed in relation to a wavelength. Namely the intensity of the reconstructed object $I'(x, y)$ is assumed to be given by

$$I'(x, y) = I(x, y) + s_i(x, y), \quad (6)$$

where $I(x, y)$ and $s_i(x, y)$ denote the intensity of the reconstructed object without the speckle and the speckle recorded by the wavelength λ_i . By the summation of $I'(x, y)$ over different wavelengths,

$$\begin{aligned} \sum_{i=1}^N I'(x, y) &= \sum_{i=1}^N I(x, y) + \sum_{i=1}^N s_i(x, y), \\ NI'(x, y) &= NI(x, y) + S, \end{aligned} \quad (7)$$

is obtained, where S is considered as a constant value given by

$$\sum_{i=1}^N s_i(x, y) = S. \quad (8)$$

This equation is based on the above-mentioned assumption. If the constant value S is negligible smaller than $NI'(x, y)$, the relation written by

$$I'(x, y) = I(x, y), \quad (9)$$

is can be obtained. Namely, by superposing the multiple reconstructed image intensity with different wavelengths, the blight and dark spots, namely speckles, are smoothed so that the image quality is improved.

However, a difficulty to superpose the reconstructed images is come up. The pixel size Δx and Δy of the reconstructed image are given by

$$\Delta x = \frac{\lambda d}{N_X \Delta X}, \quad (10)$$

$$\Delta y = \frac{\lambda d}{N_Y \Delta Y}, \quad (11)$$

respectively, where, N_X and N_Y denote the number of pixels of the digital holograms, respectively, and ΔX and ΔY denote the pixels sizes of the imaging devices, respectively (Kreis, 2005; Javidi et al., 2005). The relations mean that the pixel size in the reconstructed image varies according to the wavelength. The pixel size in the reconstructed image should be equal to superpose. From here the case Δx is explained for simplicity. To equalize Δx , one of the parameters d , N_x , and ΔX have to be changed. It is unrealistic to change distance d according to the change of the wavelength, because it is not easy to implement. One approach is to change N_X for a different wavelength by padding zeroes (Javidi et al., 2005). This is a simple and smart method, because it needs neither experimental manipulation nor signal processing. However the Fast Fourier Transform (FFT) algorithm that the sampling number is equal to the N th power of two can not be adopted.

Here, the method to change the pixel size (sampling interval) of the digital hologram by compensation is proposed. Let λ_c and λ_i ($i = 1, \dots, N$) denote a criterion wavelength and a wavelength used for recording. Using Eq. (6), the compensated sampling interval $\Delta x'$ can be written as

$$\Delta x' = \frac{\lambda_i}{\lambda_c} \Delta x, \quad (12)$$

where Δx denote the sampling interval before compensation. Base on the compensation, the pixel value (intensity) of the hologram should be changed. Linear interpolation between neighbor pixel values is adopted to determine the value of the compensated pixel. It is assumed here that the the change of the pixel value of the interferogram (digital hologram) is not sharp. Let $I(n)$ and $I'(m)$ denote the intensity of the digital hologram at the n th pixel and the intensity of the compensated digital hologram at the m th pixel, respectively. The schematic diagram of compensation of a digital hologram for a different wavelength is shown in Fig. 1. The compensated pixel value denoted by $I'(m+1)$ is given by

$$I'(m+1) = \frac{I(n+1) - I(n)}{\Delta x} \{(m+1)\Delta x' - n\Delta x\} + I(n). \quad (13)$$

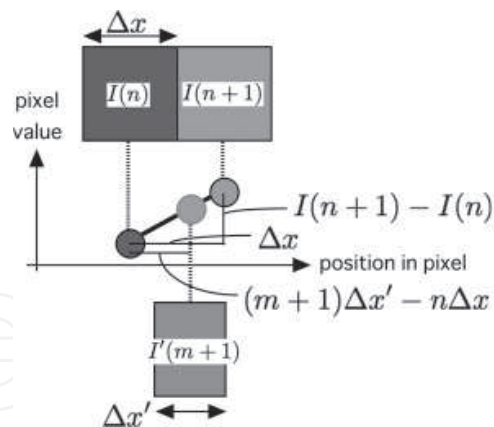

Fig. 1. Schematic diagram of compensation of the pixel value based on a linear interpolation.

Using the compensated digital holograms, reconstructed objects $U_i(x, y)$ ($i = 1, \dots, N$) are obtained. Finally the synthesized reconstructed object $|U_s(x, y)|^2$ is obtained by

$$|U_s(x, y)|^2 = \frac{1}{N} \sum_{i=1}^N |U_i(x, y)|^2. \quad (14)$$

3.2 Optical experiments

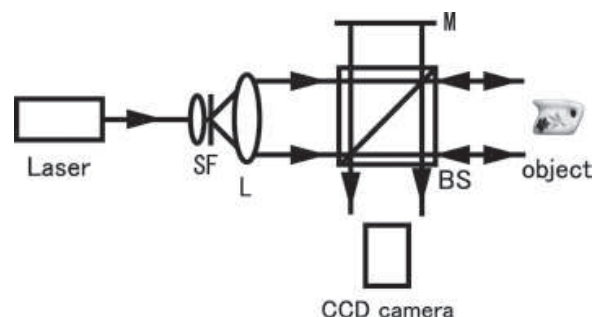

Fig. 2. Experimental setup: L, lens; SF, spatial filter; BS, beam splitter; M, mirror.

To confirm the proposed method, the optical experimental results are shown. The experimental setup is shown in Fig. 2. As a wavelength-tunable coherent light source, the dye (Rhodamine 6G) with the solid state diode-pumped, frequency-double Nd:Vanadate laser that provides 532 nm wavelength is used. For an object, a miniature pitcher with a height of ~ 2 cm shown in Fig. 3 is used. A CCD camera with 1024×768 pixels and 8 bits gray levels is used. The pixel size of the CCD is $4.65 \mu\text{m} \times 4.65 \mu\text{m}$. The distance from the object to the CCD is 520 mm. An off-axis digital holography configuration is adopted.

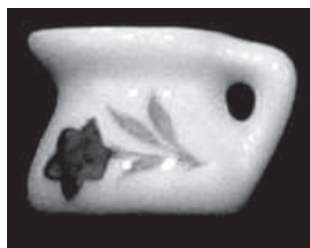
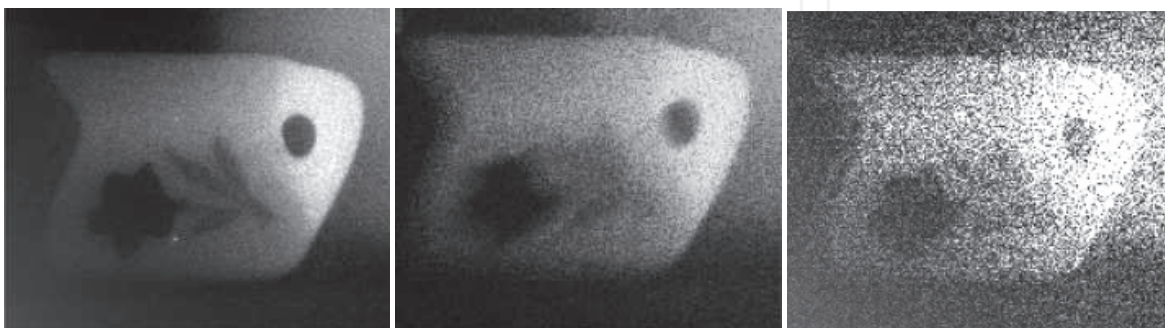

Fig. 3. A miniature pitcher as a three-dimensional object.

Thirty-eight digital holograms are recorded with the wavelength from 567 to 606 nm at an interval of ~ 1 nm. The superposed image of the thirty-eight reconstructed images by the proposed method is shown in Fig. 4(a). The superposed image without sampling period compensation is shown in Fig. 4(b). The conventional reconstructed image by a single hologram (wavelength: 567 nm) is shown in Fig. 4(c). The brightness of the upper right corner in each image is due to the dc term of the off-axis digital holography. The reconstructed images with improved quality can be seen by the proposed method. Note that the image shown in Fig. 4(a) has the bright spot on the pitcher. In Fig. 4(b), the spot is weakened by disagreement of the resolution in the reconstructed plane. In Fig. 4(c), the spot is buried in speckles. To emphasize the difference, the magnified portions of the reconstructed images are shown in Fig. 5.



(a) The proposed superposition method. (b) The superposition without sampling period compensation. (c) A conventional single hologram.

Fig. 4. The comparison of the reconstructed images.

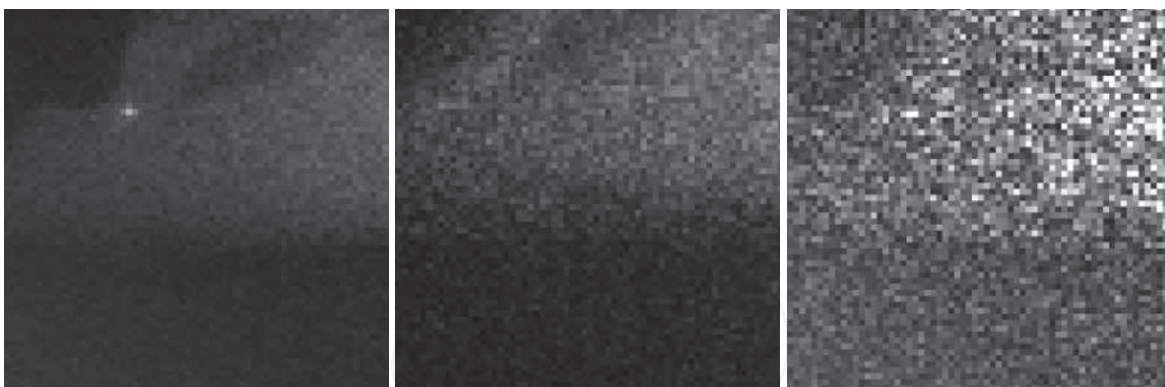

(a) The proposed superposition method. (b) The superposition without sampling period compensation. (c) A conventional single hologram.

Fig. 5. The comparison of the magnified portions of the reconstructed images.

In Fig. 6, the reconstructed images by the proposed method at various distances from the CCD are also given. In Fig. 7, the images by the conventional method are also given. From the images, the proposed method keeps the characteristics of the digital holography that has the flexibility of reconstruction distance.



(a) A reconstructed image at a distance of 520 mm (in focus). (b) A reconstructed image at a distance of 420 mm (out of focus). (c) A reconstructed image at a distance of 320 mm (out of focus).

Fig. 6. Reconstructed images by the proposed superposition method.

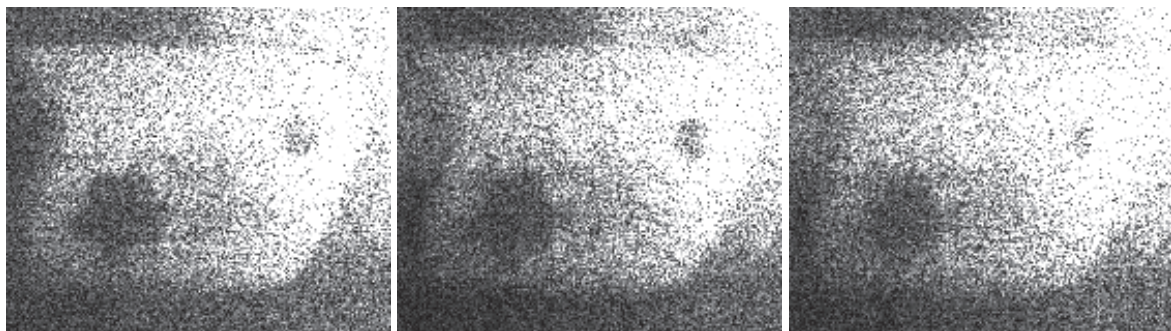

(a) A reconstructed image at a distance of 520 mm (in focus). (b) A reconstructed image at a distance of 420 mm (out of focus). (c) A reconstructed image at a distance of 320 mm (out of focus).

Fig. 7. Reconstructed images from a single hologram (conventional).

In the approach, the reconstructed image loses its phase distribution because of intensity averaging. If the phase distribution is necessary in some cases such as instrumentation, this approach is not effective. In the cases the following synthetic aperture approach will work. The method of speckle suppression should be chosen depending on the application.

4. Speckles reduction by multiple holograms

The quality of the reconstructed image is very poor, because it is suffering from the speckles due to the small extent of the hologram as mentioned in Section 2. To reduce the speckles, it is effective to use a hologram with a large extent (Binet et al., 2002). For example, if we record M holograms to be synthesized into a large extent hologram for each hologram, a good quality image will be reconstructed. In this case, the camera, which is used for digital hologram recording, has to be moved in plane for M times to obtain one large hologram. This is not practical. Here, the method to superpose digital holograms recorded from various viewing-zone angles on cyclic position.

4.1 Recording and synthesis of digital holograms

Consider the superposition of the holograms recorded from various viewing-zone angles on concyclic positions. Digital holograms of the object, which is placed on the rotational stage, from different angles are recorded by an image sensor concyclic positions as shown in

Fig. 8. In the recording process, the concerned hologram H_n and neighboring holograms H_{n-1} and H_{n+1} as shown in Fig. 9 are obtained. Figure 9 denotes two neighbors. If neighboring holograms are used to be synthesized, a large-extent digital hologram is obtained. However,

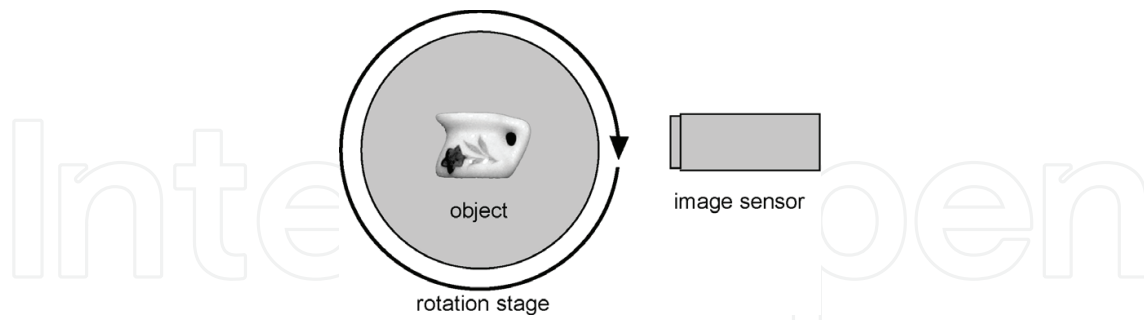

Fig. 8. Recording digital holograms by an image sensor on the concyclic positions.

simply synthesis between neighbor holograms is not available, because each hologram is in the different plane. To synthesize the holograms, holograms have to be brought on the same plane like H'_{n-1} and H'_{n+1} as shown in Fig. 9. To obtain the hologram on the same plane

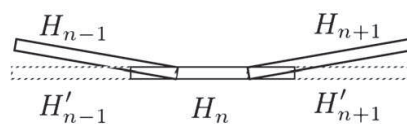

Fig. 9. A digital hologram and its neighbor holograms.

where the concerned hologram lays, the following procedure is introduced. It is assumed that the neighbor hologram $H_{n-1}(x', y')$ can be written as

$$\begin{aligned}
 H_{n-1}(x', y') &= |U_r(x', y') + U_o(x', y')|^2 \\
 &= |U_r(x', y')|^2 + |U_o(x', y')|^2 \\
 &\quad + U_o(x', y')U_r^*(x', y') + U_o^*(x', y')U_r(x', y'),
 \end{aligned}
 \tag{15}$$

where $U_o(x', y')$ and $U_r(x', y')$ denotes the complex amplitude distributions of the object wave and the reference wave on the hologram plane (x', y') . If the plane wave which incidents into the hologram at an angle is used, the third term on the right side $U_o(x', y')U_r^*(x', y')$ can be extracted using a spatial frequency filtering. After extracting the object wave information $U_o(x', y')U_r^*(x', y')$, the object wave information on the plane (x, y) is obtained numerically. For numerical calculation, it is assumed that wave propagates straightforward and only phase is changed according to the propagation distance as shown in Fig. 10. A hologram can be made

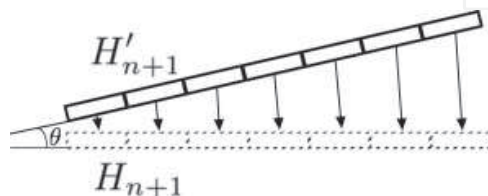

Fig. 10. Numerical propagation of the wavefront of the object wave.

using interference between the numerically obtained object wave on the plane (x, y) and the reference wave. After realignment of neighbor digital holograms, they can be synthesized by a correlational technique.

4.2 Experimental results

Experimental results are shown to confirm the feasibility of the proposed method. An optical experimental setup is shown in Fig. 11. A He-Ne laser with a wavelength of 632.8 nm is used as a coherent light source. A CCD camera is used to record the hologram. The number of pixels of the CCD camera is 1024×768 , and its pixel size is $4.65\mu\text{m} \times 4.65\mu\text{m}$. The off-axis configuration with tilting the mirror is used for the spatial separation of the zero-order and the conjugate image.

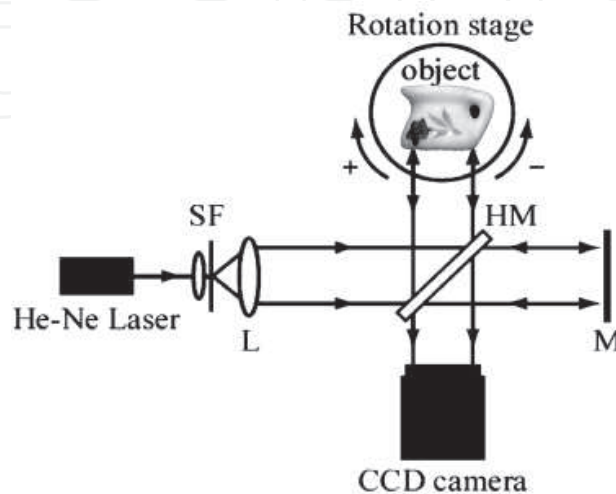

Fig. 11. An optical setup for digital hologram recording. SF: spatial filter, HM: half mirror, M: mirror, L: lens.

The distance from the object (a miniature pitcher as shown in Fig. 3) to the CCD camera is 400 mm. It is necessary to adjust the rotation angle to 0.4 deg or less to synthesize holograms, because two adjacent holograms are overlapped each other. In the experiments, the object was rotated from -180 deg to $+180$ deg at an interval of 0.2 deg and 1801 holograms were recorded. Then, some of recorded holograms were processed and superposed by the proposed method.

To confirm the feasibility of superposition, the reconstruction images from a single hologram and a superposed hologram are compared. The reconstructed images are shown in Fig. 12.

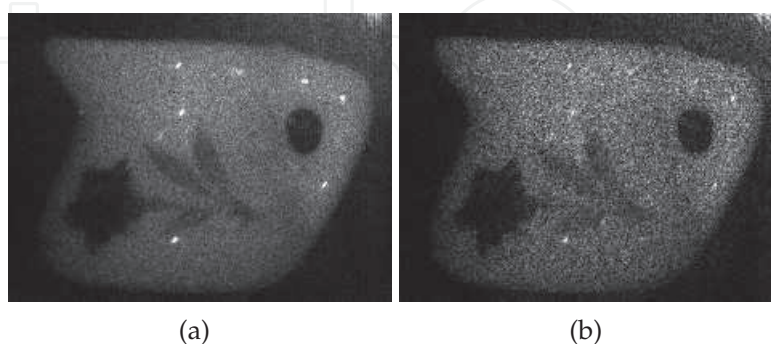

Fig. 12. Reconstructed images from (a) a synthesized hologram and (b) a single hologram.

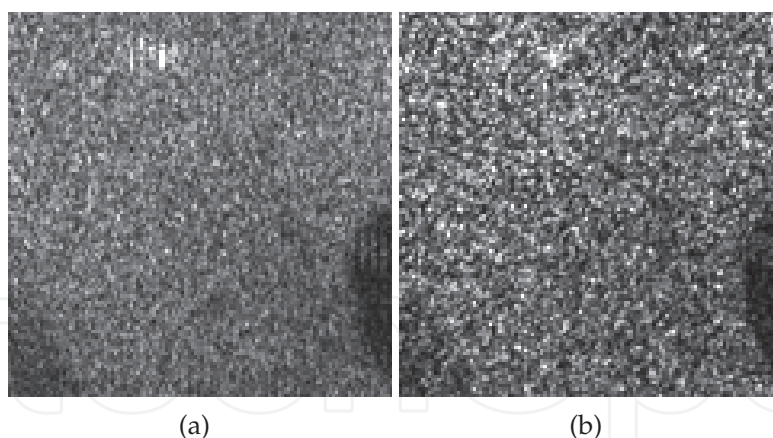

Fig. 13. Magnified portions of the reconstructed images from (a) a synthesized hologram and (b) a single hologram.

The magnified part of the each reconstructed images are shown in Fig. 13. The horizontal size of speckles in Fig. 13(a) are smaller than that in Fig. 13(b), because the size of speckles is in inverse proportion to the size of holograms. Furthermore, as neither blurred nor double images can be seen in Fig. 12(a), it is shown that the synthesis is successful.

5. Conclusion

Two methods to reduce speckle of the reconstructed image have been presented. One is the method based on the superposition of the reconstructed images with different wavelengths. Another is the method based on the multiple holograms. After a brief review of the speckle size of the digital holography, the concepts of the two methods have been described. Some experimental results have been shown to confirm the proposed methods. Some experimental results are shown to confirm the proposed methods.

6. References

- Yamaguchi, I. & Zhang, T. (1997). Phase-shifting digital holography, *Opt. Lett.* Vol. 22, 1268-1270.
- Osten, W.; Baumbach, T. & Jüptner, W. (2002). Comparative digital holography, *Opt. Lett.* Vol. 27, 1764-1766.
- Kreis, T. (2005) *Handbook of Holographic Interferometry* Wiley VCH, Weinheim.
- Ferraro, P.; Grilli, S.; Alfieri, D.; Nicola, S. D.; Finizio, A.; Pierattini, G.; Javidi, B.; Coppola, G. & Striano, V. (2005). Extended focused image in microscopy by digital Holography, *Opt. Express* Vol. 13, 6738-6749.
- Frauel, Y., Naughton, T.; Matoba, O.; Tahajuerce, E. & Javidi, B. (2006). Three-dimensional imaging and processing using computational holographic imaging, *Proc. IEEE* Vol. 94, 636-653.
- Nomura, T. & Imbe, M. (2010). Single-exposure phase-shifting digital holography using a random-phase reference wave, *Opt. Lett.* Vol. 35, No. 13, 2281-2283.
- Javidi, B. & Nomura, T. (2000). Securing information by use of digital holography, *Opt. Lett.* Vol. 25, No.1, 28-30.
- Tajahuerce E. & Javidi, B. (2000). Encrypting three-dimensional information with digital holography, *Appl. Opt.* Vol. 39, 6595-6601.

- Nomura, T.; Uota, K. & Morimoto, Y. (2004). Hybrid optical encryption of a 3-D object using a digital holographic technique, *Opt. Eng.* Vol. 43, 2228-2232.
- Poon, T.-C. & Kim, T. (1999). Optical Image Recognition of Three-Dimensional Objects, *Appl. Opt.* Vol. 38, 370-381.
- Tajahuerce, E.; Matoba, O. & Javidi, B. (2001). Shift-invariant three-dimensional object recognition by means of digital holography, *Appl. Opt.* Vol. 40, 3877-3888.
- Javidi, B. & Kim, D. (2005). Three-dimensional-object recognition by use of single-exposure on-axis digital holography, *Opt. Lett.* Vol. 30, 236-238.
- Javidi, B.; Ferraro, P.; Hong, S.-H.; De Nicola, S.; Finizio, A; Alfieri, D. & Pierattini, G. (2005) Three-dimensional image fusion by use of multiwavelength digital holography, *Opt. Lett.* Vol. 30, 144-146.
- Do, C. M.; Hong, S.-H.; Nomura, T. & Javidi, B. (2005) Multi-wavelength holographic image fusions using discrete wavelet transform, *Proc. SPIE* Vol. 6016, 60160Z-1-6.
- Maycock, J.; Mc Elhinney, C. P.; McDonald, J. B.; Naughton, T. & Javidi, B. (2005). Independent component analysis applied to digital holograms of three-dimensional objects, *Proc. SPIE* Vol. 5908, 590806-1-9.
- Kreis, T. & Schlüter, K. (2007). Resolution enhancement by aperture synthesis in digital holography, *Opt. Eng.* Vol. 46, 055803.
- Nomura, T., Okamura, M., Nitani, E. & Numata, T. (2008). Image quality improvement of digital holography by superposition of reconstructed images obtained by multiple wavelengths, *Appl. Opt.* Vol. 47, No. 19, D38-D43.
- Binet, R.; Colineau, J. & Leheureau, J. -C. (2002). Short-range synthetic aperture imaging at 633 nm by digital holography, *Appl. Opt.* Vol. 41, 4775-4782.

IntechOpen



Holography, Research and Technologies

Edited by Prof. Joseph Rosen

ISBN 978-953-307-227-2

Hard cover, 454 pages

Publisher InTech

Published online 28, February, 2011

Published in print edition February, 2011

Holography has recently become a field of much interest because of the many new applications implemented by various holographic techniques. This book is a collection of 22 excellent chapters written by various experts, and it covers various aspects of holography. The chapters of the book are organized in six sections, starting with theory, continuing with materials, techniques, applications as well as digital algorithms, and finally ending with non-optical holograms. The book contains recent outputs from researches belonging to different research groups worldwide, providing a rich diversity of approaches to the topic of holography.

How to reference

In order to correctly reference this scholarly work, feel free to copy and paste the following:

Takanori Nomura (2011). Image Quality Improvement of Digital Holography by Multiple Wavelengths or Multiple Holograms, Holography, Research and Technologies, Prof. Joseph Rosen (Ed.), ISBN: 978-953-307-227-2, InTech, Available from: <http://www.intechopen.com/books/holography-research-and-technologies/image-quality-improvement-of-digital-holography-by-multiple-wavelengths-or-multiple-holograms>

INTECH
open science | open minds

InTech Europe

University Campus STeP Ri
Slavka Krautzeka 83/A
51000 Rijeka, Croatia
Phone: +385 (51) 770 447
Fax: +385 (51) 686 166
www.intechopen.com

InTech China

Unit 405, Office Block, Hotel Equatorial Shanghai
No.65, Yan An Road (West), Shanghai, 200040, China
中国上海市延安西路65号上海国际贵都大饭店办公楼405单元
Phone: +86-21-62489820
Fax: +86-21-62489821

© 2011 The Author(s). Licensee IntechOpen. This chapter is distributed under the terms of the [Creative Commons Attribution-NonCommercial-ShareAlike-3.0 License](#), which permits use, distribution and reproduction for non-commercial purposes, provided the original is properly cited and derivative works building on this content are distributed under the same license.

IntechOpen

IntechOpen